

Some pages of this thesis may have been removed for copyright restrictions.

If you have discovered material in Aston Research Explorer which is unlawful e.g. breaches copyright, (either yours or that of a third party) or any other law, including but not limited to those relating to patent, trademark, confidentiality, data protection, obscenity, defamation, libel, then please read our [Takedown policy](#) and contact the service immediately (openaccess@aston.ac.uk)

INTEGRATED MANUFACTURING SYSTEMS DESIGN
IN A MULTI-PRODUCT COMPANY

A thesis submitted to
THE UNIVERSITY OF ASTON IN BIRMINGHAM
as the requirement for the
Degree of
DOCTOR OF PHILOSOPHY

by

Günther Kruse, M.Phil., C.Eng., M.I.Mech.E., M.I.Prod.E.,

Department of Production Engineering

September, 1977

INTEGRATED MANUFACTURING SYSTEMS DESIGN IN A MULTI-PRODUCT COMPANY

submitted by

GÜNTHER KRUSE

FOR THE DEGREE OF DOCTOR OF PHILOSOPHY, 1977

SUMMARY

Using a hydraulic equipment manufacturing plant as the case study, this work explores the problems of systems integration in manufacturing systems design, stressing the behavioural aspects of motivation and participation, and the constraints involved in the proper consideration of the human sub-system. The need for a simple manageable modular organisation structure is illustrated, where it is shown, by reference to systems theory, how a business can be split into semi-autonomous operating units. The theme is the development of a manufacturing system based on an analysis of the business, its market, product, technology and constraints, coupled with a critical survey of modern management literature to develop an integrated systems design to suit a specific company in the current social environment.

Society currently moves through a socio-technical revolution with man seeking higher levels of motivation. The transitory environment from an autocratic/paternalistic to a participative operating mode demands systems parameters only found to a limited extent in manufacturing systems today.

It is claimed, that modern manufacturing systems design needs to be based on group working, job enrichment, delegation of decision making and reduced job monotony. The analysis shows how negative aspects of cellular manufacture such as lack of flexibility and poor fixed asset utilisation are relatively irrelevant and misleading in the broader context of the need to come to terms with the social stresses imposed on a company operating in the industrial environment of the present and the immediate future.

= = = = = = =

KEY WORDS:

SYSTEM

MANUFACTURING

GROUP

MOTIVATION

CELLULAR

LIST OF CONTENTS

	<u>Page</u>
SUMMARY	
ACKNOWLEDGEMENTS	
DECLARATION	
LIST OF FIGURES	
LIST OF TABLES	
1. INTRODUCTION	1
2. BUSINESS SYSTEMS	3
2.1 The Objectives of a Business	3
2.2 Business Systems Concepts	6
2.3 Business Systems Elements	7
2.4 Feedback Theory in Business Systems	9
2.5 Is the Total Systems Concept Valid?	11
3. BUSINESS SUB-SYSTEMS	15
3.1 Problems of Systems Sub-Division	15
3.2 Sub-Systems Definition	16
3.3 Performance Co-ordination	17
4. THE MANUFACTURING SYSTEM	24
4.1 Overall Manufacturing Systems Considerations	24
4.2 Manufacturing Sub-Systems	25
4.2.1 Sub-Systems	25
4.2.2 The Technological Sub-System	26
4.2.3 The Material Control Sub-System	27
4.2.4 The Human Sub-System	28
4.3 Manufacturing Systems Analysis	32

5.	ABC COMPANY PROFILE	37
5.1	General	37
5.2	The Product	38
5.3	The Company Organisation Structure	39
5.4	The Market Environment	40
5.5	Economic Constraints	41
5.6	Manufacturing	42
5.6.1	Organisation	42
5.6.2	Manufacturing Profile	42
5.6.3	Plant Layout	43
5.6.4	Machines and Methods	44
5.6.5	The Material Control System	44
5.7	Current Problems	46
5.7.1	Demand Fluctuations	46
5.7.2	Productivity	48
5.7.3	Set-Up Cost	49
5.7.4	Parts Loading and Scheduling	49
5.7.5	Manufacturing Lead Times	50
5.7.6	Safety Stock	56
5.7.7	Summary of Major Problems	56
6.	ANALYSIS	57
6.1	Business Cycles	57
6.2	Participative Management	58
6.3	The Federal Organisation	64
6.4	Effective Performance	75
6.4.1	Factors in Effective Performance	75
6.4.2	Motivation	76

6.4.3	Task Identification	81
6.4.4	Objective Performance Measurement	82
6.4.5	Plant and Equipment	83
6.4.6	Fixed Asset Utilisation	86
6.4.7	Labour Utilisation	90
6.4.8	Work Measurement and Productivity	91
7.	THE PRODUCTION MODE	93
7.1	Introduction	93
7.2	The Structure of the Material Flow System	93
7.3	Worker Assignment	95
7.4	Work Flow	106
7.5	The Technological System	108
8.	THE ADMINISTRATIVE PROCEDURES OF THE MATERIAL FLOW SYSTEM	110
8.1	Introduction	110
8.2	Master Scheduling	111
8.3	Manufacturing Cycle Definition	112
8.4	Batch Quantity Generation	121
8.5	Capacity Planning	123
8.6	Supply - Demand Co-ordination	127
8.7	Material Control Systems Overview	128
8.8	Production Programming	131
8.9	Production Planning	133
8.9.1	The Stock Status File	133
8.9.2	Works Order Control	135
8.9.3	Capacity Balancing	136
8.9.4	Technological Scheduling	138

8.9.5	Batch Quantities	139
8.9.6	Cycling Data File	139
8.9.7	P.M.P. Generation	140
8.9.8	Works Order Documentation	141
8.9.9	Rectification	142
8.9.10	Diversions	142
8.9.11	Purchasing Orders	142
8.9.12	Order Entry and Assembly Draw-Off	143
8.9.13	Stock Control	146
8.9.14	Stock Status Update	147
8.9.15	The Stores Function	148
8.10	Production Control	149
8.11	Quality Control	150
9.	DISCUSSION	156
9.1	Integration in Systems Design	156
9.2	The "New" Approach to Manufacturing Systems Design	160
9.3	The Production Mode	161
9.4	Human Aspects	163
9.4.1	The Socio-Technical Revolution	163
9.4.2	A Problem of Change	165
9.4.3	A Need for Compromise	168
9.4.4	Delegation of Responsibility	170
9.4.5	Easing the Monotony of Work	172
9.4.6	A Simplified Operating Environment	172
9.5	Effectiveness of the Proposed Production Mode	173
9.5.1	Objective Satisfaction	173
9.5.2	Other Criteria of Judgement	177

9.6	The Administrative Sub-System	180
9.7	Some Observations on the Project Work	182
10.	CONCLUSIONS	187
10.1	General Conclusions on Manufacturing Systems Design	187
10.2	Motivational Aspects	188
10.3	Some General Principles of Manufacturing Systems Design	189
10.4	General Conclusions on the Project Work	191
11.	FUTURE WORK	193
APPENDICES		
APPENDIX I	E.B.Q. Calculations	198
APPENDIX II	The Pilot Cell	204
APPENDIX III	The Pilot Product Centre	210
APPENDIX IV	Definition of Terms	222
REFERENCES		225
TABLES		
FIGURES		

ACKNOWLEDGEMENTS

A study of the breadth presented in this thesis must, from necessity, contain contributions from a number of co-workers. As an applied industrial project, the persons involved are too numerous to mention each one individually. However, I am particularly indebted to:

My supervisor, Professor R.H. Thornley, for guidance and support throughout the project.

Dr. G. Beaumont, who, as associate supervisor, contributed with many suggestions and ideas during the study.

Mr. C.F. Smith, Vice President, who authorised the project, and whose management style made research into some of the more advanced motivational concepts acceptable to the sponsoring Company.

Mr. J.G. Nicholson, Manager - Manufacturing and Planning, who, as my direct superior, gave support and encouragement at all times.

Mr. J.H. Churchill, Site Director, who, in a professional as well as a personal sense, was the real driving force behind the project.

Mr. R.E. Hinds, Special Projects Co-ordinator, whose friendship and help was invaluable in the development of the project work.

Mr. D. Parham, M.I.S. Manager, who specifically reviewed all control systems aspects discussed in this thesis and gave much helpful advice.

My Wife, Anne, who supported me with considerable patience and fortitude.

Mrs. H. Ploughright, who prepared most of the illustrations.

The case studies illustrated in the appendices were developed as a joint project with various members of the Company concerned, notably, Mr. R.E. Hinds and Mr. A. Spears.

DECLARATION

No part of the work described in this thesis has been submitted in support of an application for another degree or other qualification of this or any other Institution.

The industrial project work was done by the author himself or under his supervision.

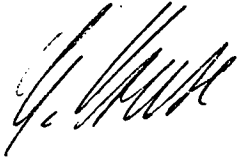

G. Kruse

September, 1977

LIST OF FIGURES

- Figure 1 The Organisational System
 (after Kast, Johnson & Rosenzweig)
- Figure 2 Relationship of Business Sub-Systems
- Figure 3 Integrated Group Technology
- Figure 4 Plant Control System - Block Diagram
- Figure 5 A Simplified Representation of a Manufacturing
 Company as a Closed-Loop System
 (after Roots)
- Figure 6 Company Sub-Systems
- Figure 7 Company Organisation Structure
- Figure 8 Company Organisation Structure
- Figure 9 Manufacturing System - Block Diagram
- Figure 10 Relationship of Manufacturing Sub-Systems
- Figure 11 Manufacturing Environment
- Figure 12 Manufacturing Systems Design - Old Approach
- Figure 13 Manufacturing Systems Design - New Approach
- Figure 14 Systems Study Time Phasing
- Figure 15 Divisional Organisation Structure

- Figure 16 The Business Cycle 1960 - 1976
- Figure 17 Manufacturing Organisation Structure
- Figure 18 Vane Pump Assembly
- Figure 19 General Systems Outline
- Figure 20 In-House Parts
- Figure 21 Vendor Part Control
- Figure 22 Order Build
- Figure 23 Works Order Delay Pattern - Machine Number 020961
- Figure 24 Works Order Delay Pattern - Machine Number 002038
- Figure 25 Works Order Delay Pattern - Machine Number 000951
- Figure 26 Works Order Delay Pattern - Machine Number 050013
- Figure 27 Works Order Delay Pattern - Machine Number 000915
- Figure 28 Works Order Issue Pattern - Total Plant
- Figure 29 Customer Demand Amplification
- Figure 30 Sinusoidal Order Intake
- Figure 31 Hierarchical Management Structure
- Figure 32 Federal Business Organisation
- Figure 33 Federal Manufacturing Organisation

- Figure 34 Workers' Playtime
- Figure 35 Manufacturing Cost/Machine Availability Relationships
- Figure 36 Production Flow Pattern
- Figure 37 Plant Organisation Structure
- Figure 38 Product Centre Management Structure
- Figure 39 Plant Layout Block Diagram
- Figure 40 Stock Levels in Linked Machining/Assembly Programmes
- Figure 41 Linking Machining and Assembly
- Figure 42 Material Control System - Hierarchical Structure
- Figure 43 Material Control System - Block Diagram
- Figure 44 Systems Overview
- Figure 45 Capacity-Matched Forecast File Generation
- Figure 46 Machine Load Report
- Figure 47 Labour Load Report
- Figure 48 Master Schedule Generation
- Figure 49 Stock Status Print-Out - Current Format
- Figure 50 Stock Status Report Format

- Figure 51 Period Machining Programme
- Figure 52 Technological Scheduling Code Example
- Figure 53 Period Machining Programme Generation
- Figure 54 Assembly Draw-Off
- Figure 55 Assembly Draw-Off Phasing
- Figure 56 Pilot Cell Lay-Out
- Figure 57 View of Pilot Cell
- Figure 58 View of Pilot Cell
- Figure 59 Product Centre Schematic
- Figure 60 Product Centre Layout
- Figure 61 Cycle Calendar
- Figure 62 Product Centre Organisation Chart

LIST OF TABLES

TABLE I	Key Objective Analysis
TABLE II	Objective Conflict Analysis
TABLE III	Order Lead Time
TABLE IV	Happiness (after Sunday Times)
TABLE V	Machined Parts Lead Times
TABLE VI	Pilot Cell Operating Results
TABLE VII	Product Centre Parts Cycling

FOREWORD

The most critical problem to be faced in modern large-scale complex systems is complexity itself. Unnecessary complexity is largely attributable to the beaurocratic approach to systems project management.

(W. P. Chase)

1. INTRODUCTION

Most of the technological problems of industry have been solved and documented, notably in the general batch production industry. Nevertheless there still appear to be considerable problems in many firms, mainly in the areas of industrial relations, communication and control.

The company discussed in this study (subsequently referred to as the ABC Company) is probably one of the better financed organised firms operating in the U.K., and has solved many of its technical manufacturing problems. Its control systems are sophisticated and operate well. A cellular shop lay-out was introduced some years ago and the Company's product line is in many ways ideal for a group-technology type manufacturing system.

Despite its advantages, the Company still suffered from problems however, mainly concerned with delivery performance, control problems and inventory levels higher than would be expected in their particular manufacturing environment. There was also a noticeable lack of integration of the individual functional departments.

One popular method of solving complex systems problems is known as "Systems Engineering", also referred to as the "Systems Approach". The concept had its birth in advanced engineering environments such as the aerospace industry, where technological problems became so complex, consisting of a vast number of interrelated elements, that problem solution became difficult and even impossible by conventional means. Systems Engineering viewed such a problem as a conglomeration of separate but interrelated elements. By defining each element and its interface relationship to other systems elements it was possible to solve each element in turn, whilst still accounting for its effect on

the overall system behaviour.

A reasonably sized multi-product manufacturing business is, of course, a most complex system, requiring the co-ordination of a vast number of activities, such that the composite objective performance of all elements yields overall optimisation. Not surprisingly, analysts in recent years have taken an increasing interest in the philosophy and methodology of systems engineering to solve business problems.

The work presented here describes the design of a manufacturing system, concentrating on the human sub-system and the material flow sub-system, but making reference to other systems elements as necessary to present an integrated systems approach. Specifically, the report illustrates the integration of manufacturing technology with systems engineering and behavioural psychology.

A decision by the Management of the ABC Company to apply Group Technology in its manufacturing area provided an opportunity to develop systems requirements by analytical study.

Whilst elements of G.T. were certainly recommended, the study has tried to avoid pre-conceived bias and the report shows an attempt to study the manufacturing systems problem from first principles.

Whilst the project covers a complex multi-plant organisation, the data presented is based on the results across one plant of the company only. The area defined in the Company Survey below can, however, be regarded as a homogenous system and little is lost in the systems simplification. The field study did take into account interface requirements between the plants under study and, indeed, it was the purpose of the analysis to develop a theory of manufacturing systems design, applicable to other plants in the ABC Company.

2. BUSINESS SYSTEMS

2.1 THE OBJECTIVES OF A BUSINESS

Before a business system can be analysed, it is necessary to be clear about the purpose of the business. Considering in particular the commercial enterprise, Drucker (1) points out that the first objective of the business is economic performance. As such the first purpose of the business is "to create a customer" and the two basic key functions of the enterprise are

marketing and

innovation

The marketing aspect covers market definition, product specification and product selling. Innovation covers a wide range of activities concerned with the product design, development and manufacture, but also any other activity which makes the product more attractive to the customer in terms of cost, performance or availability.

Viewing the total business as a "black box" (2), the following basic elements can be considered:-

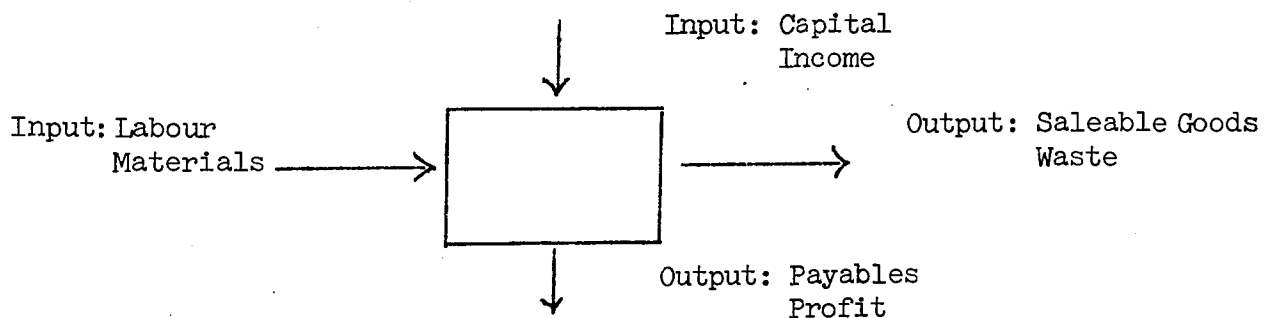

For equilibrium:-

$$\text{Input} = \text{Output}$$

$$\text{Labour} + \text{Materials} + \text{Capital} + \text{Income} = \text{Goods} + \text{Waste} + \text{Payables} + \text{Profit}$$

In our society, a company's financial performance is gauged on the basis of profit in relation to capital input. Thus, in purely economic terms, systems optimisation is achieved if the ratio of profit to capital (Return on Assets) is a maximum.

Taking return on assets (R.O.A.) as the key economic objective, it can be shown that

$$\text{R.O.A.} = \frac{\text{Sales} - \text{Cost of Sales}}{\text{Fixed assets} + \text{Stocks}}$$

Thus the major economic performance objectives of the company become

- i) Maximise sales revenue
- ii) Minimise cost of Sales
- iii) Minimise fixed assets
- iv) Minimise stocks

Various trade-offs are apparent which complicate the analysis:-

- a) There is a likelihood the sales volume varies inversely with price
- b) Costs vary inversely with volume
- c) Costs are a function of fixed assets
- d) Sales (as a function of customer service) are a function of stocks

There is thus a need for a business objective profile, such that controlled sub-optimisation of specific economic objectives leads to an overall systems optimisation.

At this point it is interesting to note that Drucker (1) specifies the economic objective of the business not as one of profit maximisation, but rather as "the avoidance of loss". This objective is more difficult to handle in analysis than the simple profit maximisation usually preferred by economists. It does, however, provide a more realistic assessment of the modern business environment.

A business is generally part of a broad supply/demand system, where it supplies a certain proportion of total market demand. In such an environment, the business must be able to at least maintain its competitive position, i.e. be at least as innovative as its competitors.

Considering the divorce in public corporations between ownership and management, the profit maximisation objective becomes particularly meaningless. Modern industrial management relies on leadership by salaried professionals whose personal objective will, to a not insignificant extent, be long term survival (i.e. job security) and to a lesser degree, profit maximisation, where they will only share to a limited extent the benefits of their strategy. Furthermore, long planning cycles make short-term profit maximisation an unsuitable strategy (3), and long-term growth is likely to be more acceptable.

Management's criterion of success is likely to be "honourable survival" i.e. maintenance of a growing business with improving profitability over long periods of time.

Long term growth requires, of course, capital inflow which may either be retained capital, implying high profitability, or externally attracted capital, implying attractiveness of the business in the capital market. It is likely that growth will be financed by a combination of both. The first business objective must, therefore, be the presentation of a healthy, stable growth organisation to the open capital market.

The objective of "honourable survival" is thus favoured, firstly by the stock exchange, rewarding as a general rule steady profitable growth with often relatively low yield, secondly by the modern industrial climate, pressing for long term stability and limited

fluctuations in labour requirements, and thirdly, by the management team concerned.

Economic business objectives in a modern corporation are therefore likely to be

- increase return on assets progressively,
- increase market share progressively,
- increase fixed asset base progressively,
- maintain a dependable steady business of predictable growth and profitability (i.e. avoid surprises).

2.2 BUSINESS SYSTEMS CONCEPTS

There has been a tendency in recent years to apply systems theory to solve business problems. In this approach the business is treated as an operational system and the behaviour of the system to internal and external influences is studied.

One definition of a system is "... an integrated assembly of interacting elements, designed to carry out co-operatively a pre-determined function" (4), another "... an array of components designed to accomplish a particular objective according to plan." (2)

The key to systems understanding is the appreciation that one is dealing with ... a group of elements which collectively and interactively are called upon to meet a specified objective, and which must be integrated to successfully perform the task. Where Timms and Pohlen (5) quote that "The organisation is ... usefully viewed as a system composed of interrelated functional sub-systems ..." it must be noted that a considerable management literature deals with specific functional aspects in isolation and fails to clearly identify, firstly, interfaces between functional areas and, secondly, constraints imposed

by other sub-systems which must be observed to ensure that sub-systems optimisation does not lead to overall systems' sub-optimisation.

A typical simple example of such sub-systems' optimisation acting to the detriment of the overall systems optimisation is the use of the economic batch quantities without due regard to maximum lead times, customer service and capital availability.

2.3 BUSINESS SYSTEMS ELEMENTS

Timms and Pohlen (5) limit their total business system to the following systems elements:-

1. The functional sub-system
2. The information system
3. The decision system

The concept is useful in business analysis but it is essential to add:

4. The human system,

dealing with behavioural aspects of people within the other systems elements. The industrial psychology literature is extensive, and ample evidence exists that the behavioural system is important and cannot be neglected. Johnson, Kast and Rosenzweig (6) take account of this aspect in their description of the organisational system (Fig.1), where they identify the psychosocial sub-system. Like Timms and Pohlen, they appear to have problems in breaking the overall management, decision and information structure into meaningful sub-systems and settle for a structural sub-system with a broad, overlaid managerial sub-system.

One can thus visualise the business system as a set of functional sub-systems which are related inter-systems. The information system could in the past be regarded as an integral part of the functional

sub-systems, but with the advent of E.D.P. systems, the centralised information system may be better regarded as an "overlay" on the functional systems.

Figure 2 shows pictorially the total systems concept and indicates the considerable complexity of connectives. The need for systems which minimise these is already evident. The pictorial view also indicates why E.D.P. systems failed in the past to offer the magic solution to business systems problems. To limit total systems design to information and decision systems design (the areas largely covered by E.D.P. systems), assumes that human systems and functional sub-systems will be compatible with E.D.P. systems. Such an assumption, stated or implied, will not necessarily be valid.

A more useful approach has been the application of Group Technology (G.T.) where an inherently integrated approach is normally recommended (7). However, even the broadest G.T. systems have to date concentrated on production and sometimes engineering (i.e. research, development, design). Whilst admittedly the better examples of G.T. analysis (8, 9, 10) have integrated the four systems elements quoted above to some degree, they have generally failed to consider the relationship between all functional sub-systems, input/output factors and environmental disturbances/constraints to the extent necessary to ensure total systems optimisation.

In principle, G.T. analysts have progressed along the correct route, but have not generally taken their analysis far enough back to analyse the effect of their objectives and strategies on the company as a whole. The work has tended to concentrate on manufacturing systems design.

The integrating nature of G.T. is indicated pictorially in Fig.3,

which shows the interrelationship of its major features jointly leading to an improved overall system.

2.4 FEEDBACK THEORY IN BUSINESS SYSTEMS

Control of a business is based on the principle of closed loop feedback. The complexity of the business environment with its random influences makes open loop control impossible in all but the very simplest cases.

Forrester (11) states that "Every decision is made within a feedback loop. The decision controls actions which influences the decision. A decision process can be part of more than one feedback loop." "The feedback loop is the basic structural element in systems. Dynamic behaviour is generated by feedback. The more complex systems are assemblies of interacting feedback loops ... Interconnecting feedback loops form any system."

Various references draw analogies between business systems and servo systems (5, 12, 13, 14) and, indeed, the comparison is apt, since business systems generally exist as complex feedback systems.

A typical business system macro block diagram for a company supplying capital goods from stock, illustrates the principle. In Figure 4, sales are met from stock and new orders are generated from two feedback loops

- i) a forecast which is assumed to be a function of past sales
- ii) a stock level adjustment which modifies works orders on the basis of actual stock level variations from a specified nominal service stock.

Such a system is in practice invariably non-linear, and the mathematical analysis can be complex. The input may be a combination of exponential

growth, approximately sinusoidal variation of varying frequency and amplitude with random disturbances. Non-linear constraints (materials, labour and machine capacity) are certain to exist.

Typically, the requirements of the business system in Figure 4 are:-

- i) the fluctuation of θ_7 , the plant output (equal to, but phase displaced from θ_6 , the plant order input, if losses such as scrap are ignored) must be a minimum. Thus sinusoidal and random fluctuations must be strongly damped by the forecasting and stock level adjustment formulae but steady growth or decay of θ_1 must be reflected in θ_7 .
- ii) more complex still, the fluctuations of θ_2 and the stock level, must be controlled such that stock levels are minimised. The need to minimise θ_2 must be balanced by the need to minimise the fluctuations of θ_7 . Commonly management would minimise θ_2 within constraints of maximum fluctuation of θ_1 .
Clearly much stress is laid on the forecasting formula since stock is minimised by minimising the difference between θ_1 and θ_7 . θ_3 must reflect the anticipated fluctuations in θ_1 since, due to the plant time delay ϕ , θ_3 must look ahead such that when θ_6 is converted to θ_7 , the value of θ_7 will as closely as possible track the changes in θ_1 .
- iii) The time lag ϕ of the plant causes errors between input θ_6 and sales θ_1 which may be, firstly, steady state errors due to the time constants of the system, and secondly, errors due to the unpredictable change in frequency and growth (or decay) of θ_1 and the effect of random disturbances in the system.
These errors are accumulated as θ_2 .

In any business it is clearly essential that stock is maintained within acceptable limits. It cannot be allowed to drop too far below the nominal service stock, but at the same time it must not be allowed to grow continuously.

Whilst the analogy of servo systems is used, analysis of real life models is difficult (15), and practitioners generally prefer dynamic model building and simulation to study the system. Notably Forrester's work in Industrial Dynamics (16) has greatly influenced analysts.

Generally a business operates on an environment where an uncertain future or random fluctuations make open loop systems unacceptable and the feedback principle is an essential part of business systems.

A discussion of business feedback systems by Roots (17) shows a basic block diagram of a medium sized manufacturing company (Fig.5). This diagram forms a useful tool for analysis of the basic relationship of variables. At the same time the block diagram is complex but, as Roots is the first to admit, incomplete, confirming that standard servo theory leads to useful concepts, but that analysis of meaningful models requires simulation techniques rather than mathematical solution of servo systems.

2.5 IS THE TOTAL SYSTEMS CONCEPT VALID?

The total systems approach is discussed by Spaulding (13) who questions its validity.

The total systems approach is described as the "... design (of) the business system in terms of flows of information, materials, money and people, and to persuade members of the enterprise to adopt the

system or sub-system so designed."

Spaulding claims never to have seen or read of an instance where this has been achieved and suggests that the reasons may be

- i) that systems theory treats systems elements as components and is mainly concerned with the flow between elements, rather than the make-up of the elements themselves
- ii) that systems theory is weak in describing human behaviour and thus tends to ignore the behaviour of the most significant systems contents

It seems that total-systems-analysts have tended to be too preoccupied with procedures of controlling flow, notably information flow. They have also tended to think in terms of complex centralised systems control and advanced computer algorithms to optimise the total system.

No wonder that little progress has been made. The kind of total system shown in the literature (5) is too complex and is closely interlinked to make modular construction of the total system difficult. There has been a tendency amongst computer manufacturers in recent years to supply systems soft-ware in modular form (18, 19), allowing step-by-step implementation, but ensuring that all sub-systems interfaces are clearly defined.

Such work has lead the way to a better appreciation of the total systems concept. The total system, as indicated earlier in this text, should not be regarded as one homogenous system without internal split, but instead as a collection of open sub-systems, each one linking with some or all others, but each one with its own boundaries.

Seen in this light, the total system becomes a manageable reality, where the introduction of a total systems concept can progress in a

modular manner.

Indeed, Chase (20) indicated that failure to consider total systems requirements initially, leads to the establishment of a number of relatively independent functional sub-systems which will be difficult to integrate. He further suggests that this is one reason for common user dissatisfaction with the total systems concept.

Bedworth (14) confirms, "It is important to realise that the over-all system should be considered initially, not the components."

The need to integrate the sub-systems is obvious, but mechanics of the systems design for large systems work against the principle. Functional fractionalisation can hardly be avoided in a complex system. However, the alternative of condemning the overall systems approach is hardly helpful. The latter policy condones the establishment of unco-ordinated functional sub-systems and avoids the problems of systems integration by assuming such integration to be impossible.

There can be little doubt that the overall systems approach is the only one likely to lead to overall systems optimisation, and project management tools must be developed in such a manner, that the approach is feasible in its execution.

Typically, it should utilise the following project stages

- Overall systems analysis
- Definition of sub-systems and their boundaries
- Sub-systems boundaries definition for minimum connectives between sub-systems to minimise integration problems
- Development of sub-systems with continuous feedback to overall systems management to ensure sub-systems compatibility

To underline the above discussion, it is interesting to list some systems requirements quoted in the U.S. Air Force Command Manual 375-5 (21)

- "A system must be designed and tested as a complete entity."
- "All parts of a system must have a common unified purpose."
- " ... Systems Engineering must deal with total system design. As such, it is a unique activity and is not to be confused with the detail design of end items and components."

3. BUSINESS SUB-SYSTEMS

3.1 PROBLEMS OF SYSTEMS SUB-DIVISION

Before one can meaningfully discuss the sub-systems of a business system, the systems environment needs to be defined.

In order to simplify the discussion, the following test is restricted to a manufacturing company, producing engineering assemblies for the capital goods industry.

Irrespective of the problems of functional specialisation of business sub-systems, the wide range of knowledge and experience required to understand all aspects of the business system requires a large company organisation which, at its top management level, is divided into major functional areas.

A popular split into sub-systems is:-

Marketing

Manufacturing

Engineering

Services: Finance

Data Processing

Personnel

On the face of it, whilst by far the most common, this is probably the worst company structure. The split is purely by functional expertise and business objective achievement is likely to be biased towards the strongest and/or most capable executive's functional objectives.

There is little doubt, confirmed in the literature (1), that the key problem of functional organisation lies in the parochialism and limited objectives of each functional specialist. One must recognise

Minimise manufacturing cost	-	maximise quality level
" " "	-	maximise technical performance
" " "	-	follow demand fluctuations
Minimise inventory	-	maximise delivery performance
" "	-	follow demand fluctuations
" "	-	maximise sales
Minimise debtors	-	maximise sales
" "	-	maximise technical performance
" "	-	ensure steady sales growth
Maximise delivery performance	-	maximise quality level
" " "	-	maximise technical performance
" " "	-	limit plant output fluctuations
Maximise quality level	-	minimise quality cost
Minimise quality cost	-	maximise technical performance
" " "	-	maximise sales
" " "	-	ensure steady sales growth
Follow market fluctuations	-	limit plant fluctuations
Limit plant fluctuations	-	maximise sales
Maximise price	-	maximise sales
" "	-	ensure steady sales growth
Minimise other costs	-	maximise advertising and promotion

These conflicts can be sorted into related conflict groups as follows:

GROUP A

- | | | |
|-----------------------------|---|-------------------------------|
| Minimise manufacturing cost | - | minimise inventory |
| " " " | - | maximise delivery performance |
| Minimise inventory | - | maximise delivery performance |

GROUP B

- | | | |
|-----------------------------|---|-----------------------|
| Minimise manufacturing cost | - | minimise fixed assets |
|-----------------------------|---|-----------------------|

GROUP C

- | | | |
|-------------------------------|---|--------------------------------|
| Minimise manufacturing cost | - | maximise quality level |
| " " " | - | maximise technical performance |
| Minimise fixed assets | - | maximise technical performance |
| Maximise delivery performance | - | maximise quality control |
| " " " | - | maximise technical performance |
| Maximise quality level | - | minimise quality cost |
| Minimise quality cost | - | maximise technical performance |
| " " " | - | maximise sales |
| " " " | - | ensure steady sales growth |

GROUP D

- | | | |
|--------------------|---|----------------|
| Minimise inventory | - | maximise sales |
|--------------------|---|----------------|

GROUP E

- | | | |
|-------------------------------|---|---------------------------------|
| Minimise manufacturing costs | - | follow demand fluctuations |
| Minimise inventory | - | follow demand fluctuations |
| Maximise delivery performance | - | limit plant output fluctuations |
| Follow market fluctuations | - | limit plant fluctuations |
| Limit plant fluctuations | - | maximise sales |
| Minimise manufacturing cost | - | minimise lead time |

GROUP F

Minimise debtors	-	maximise sales
Maximise price	-	maximise sales
Maximise price	-	ensure steady sales growth
Minimise "other" costs	-	maximise advertising and promotion

The groups can be further rationalised as

GROUP A:-	Minimise cost)	
	Minimise inventory)	Manufacturing
	Maximise delivery performance)	Objectives
GROUP B:-	Balance fixed assets with cost)	Industrial Engineering Objective
GROUP C:-	Specify i) required performance)	
	ii) required policy to develop)	Product
	a growing product market)	Planning Group
GROUP D:-	Set Service levels)	Policy
GROUP E:-	Specify strategy to follow)	Company strategy
	market fluctuations)	based on analysis
GROUP F:-	Sales strategies)	

Groups A and B are internal manufacturing objectives.

Group C forms a marketing/manufacturing/engineering interface group.

Groups D and E can be combined as a marketing/manufacturing interface group, dealing with supply/demand co-ordination. This interface would also deal with such aspects as determining plant capacity, supplying delivery dates, and setting up production programmes.

This group must be independent from marketing and manufacturing to avoid bias and consequent sub-optimisation. It controls the company's inventory policy to some degree and, whilst raw material and work-in-progress minimisation are manufacturing objectives, finished goods minimisation is a supply/demand group objective.

Figure 6 shows the company sub-systems which became apparent from the above analysis and Figure 7 shows a typical outline organisation chart to support such a system.

Distribution would logically be placed under the supply-demand group.

An interesting aspect of such a company structure is the high status afforded to product planning and supply/demand co-ordination. These functions are normally absorbed by the manufacturing, marketing and engineering sub-functions. It is difficult to visualise how a company can achieve a balanced objective compromise without the balancing functions of

- product planning, and
- supply/demand co-ordination

A further function, however, is required in the form of Planning, to concern itself with long range planning aspects of the business.

Line managers are invariably and understandably guided by short term requirements and a separate function is required to look after the long term objectives of the company. In many ways the long range planning function is inherently incorporated in product planning as well as supply/demand co-ordination. Both functions balance the long term and the short term objectives of the business to ensure long term business growth. They enforce certain requirements on marketing,

engineering and manufacturing, to ensure that the long term objectives of the company are adequately considered.

Combining the long range planning aspects of the business, the company structure as per Figure 8 can be drawn up.

There is a good case for including engineering as a planning sub-function, but in the ABC Company engineering is a major and critical business activity demanding top management representation. It is thus preferable to maintain a separate engineering function. It should be noted, however, that engineering is a service and not an executive function, and as such it has been shown as a staff service in Figure 8.

Serck Audco (23) has used the approach of decoupling manufacturing from marketing, through a materials planning function, similar to the concept above, but has probably taken it too far, thus removing from the manufacturing system some of its control mechanism. In the structure described in this text, the manufacturing system is totally responsible for its overall day-to-day output. The planning function is more concerned with longer term aspects and the marketing/manufacturing conflict. In the Serck case, the planning function actively controls the manufacturing system and denies its right to autonomy.

3.3 PERFORMANCE CO-ORDINATION

The problems of specialisation and bureaucracy will be discussed later in this thesis, and it will suffice at this stage to mention that poor co-ordination is likely to result from the structure described previously. A group-type co-ordination structure such as described by Likert (24) is required. A committee structure is

suggested to cut across the departmental boundaries. The ABC Company already used Business Planning Committees for specific major projects such as new product introduction. A new product Business Planning Committee would typically have representatives from

- Product Planning (Chairman)
- Engineering
- Manufacturing
- Finance
- Marketing

The Committee would be responsible for the new product introduction. Other committees suggest themselves, such as

Executive Committee:

Chief Executive
 Marketing Director
 Planning Director
 Manufacturing Director
 Staff Executives

Supply-Demand Board:

Head of supply-demand co-ordination
 Marketing representative
 Manufacturing representative

Motivation and Productivity Board:

Management Services Executive
 Personnel Executive
 Marketing representative
 Planning representative
 Manufacturing representative

The idea of management committees is not new of course, and was successfully applied by General Motors as far back as 1923 (25).

4. THE MANUFACTURING SYSTEM

4.1 OVERALL MANUFACTURING SYSTEMS CONSIDERATIONS

There is a tendency to regard low cost as the prime manufacturing objective to the detriment of such requirements as customer satisfaction, flexibility and quality. Such a strategy leads to dangerous sub-optimisation, perhaps even business failure. Thus "Manufacturing affects corporate strategy and corporate strategy affects manufacturing" (26).

Using the systems breakdown evolved previously, the objectives of the manufacturing systems can be stated as

- Produce products to a given specification and quality level as furnished by the product planning group
- Produce products to volume and delivery specified by the supply-demand co-ordination group
- Agree acceptable lead times with the supply-demand co-ordination group
- Adjust long term capacity and capability to meet long range planning objectives
- Produce to balance minimum cost with productive inventory, subject to lead time, specification and quality constraints

The manufacturing system is, therefore, purely concerned with the manufacture of goods to delivery date, cost, and specification. This is a somewhat narrower view than that taken by other writers. The advantages of removing aspects of forecasting, finished goods inventory control, distribution and other areas commonly allocated to the manufacturing function has been discussed previously.

The same discussion does show, however, that manufacturing is closely affected by decision making in the product planning and supply/demand co-ordinating function. Thus to study the manufacturing activities of a company one must analyse:

- a) the manufacturing sub-system
- b) the production planning sub-system
- c) the supply/demand co-ordination sub-system

To appreciate the relationship of the functional areas involved, figure 9 shows a block diagram for a typical manufacturing system in a machinery assembly plant.

4.2 MANUFACTURING SUB-SYSTEMS

4.2.1 SUB-SYSTEMS

Three manufacturing sub-systems have been suggested in the literature (27)

- I The technological sub-system
 - product specification
 - fixed assets
 - methods, tooling and fixtures
- II The material control sub-system
 - plant lay-out
 - loading
 - scheduling
 - flow control
 - resource utilisation
 - capacity planning

- productive inventory control
- manufacturing quantity control

III The human sub-system

- behavioural psychology
- motivation
- payment systems
- human skills

Overlaid are again, as in the overall business system:

- A. the decision sub-system
- B. the information sub-system

which are closely interlinked, forming the administrative structure of the manufacturing system and involving such areas as

- procedures
- documentation
- E.D.P. systems
- organisation structure

Timms and Pohlen (5) define the following sub-system of the Organisation

Finance

Personnel

Distribution

Operations

Purchasing

Manufacturing

Marketing

Product planning

The suggested split does suffer from the short-comings of functional specialisation discussed earlier and requires close co-ordination between the individual sub-systems. It is unlikely that in a large plant the sub-systems can be run as separate activities and still be adequately linked for performance optimisation. Whilst it appears to be possible to split the overall business system into meaningful sub-systems with well defined boundaries, the manufacturing sub-systems are intertwined to such an extent, that boundary definition becomes impossible.

Recognition of this problem has led in recent years to an increasing interest in parallel operation of manufacturing sub-systems, based not on functional boundaries, but on product/technological boundaries such as component similarity (G.T.manufacturing centres) (7) or product similarity (product centres) (28).

The objective of such a systems breakdown is the formation of manufacturing centres of limited size, such that the functional sub-systems discussed earlier can be more easily integrated by management effort within each manufacturing centre.

Figure 10 shows the relationship of the functional sub-systems in schematic form, illustrating the extensive interrelationships. The diagram splits material control into two separate sub-systems, namely

- material flow
(programming, scheduling, layout, etc.)
- quantity control
(inventory control, manufacturing quantity control)

The environment governing the specification of the major sub-

systems is shown on Figure 11. The ringed area incorporates the manufacturing system which is governed by the following factors:

Internal:-	Technology
	Administration
	People
External:-	Product
	Market demand
	Finance
	Objectives
	Strategy
	External constraints

The building of an effective manufacturing system principally consists of structuring the internal systems factors within the limitations, constraints and demands of the external factors.

This does not preclude that the manufacturing systems designer can influence the external factors. Indeed, the manufacturing systems analyst must actively participate in such external decisions as

- product variety
- delivery policy
- business strategy
- capital allocation

4.2.2 THE TECHNOLOGICAL SUB-SYSTEM

The technological sub-system is concerned with the manufacturing technology such as:

- process planning

- machine tool selection
- tool and fixture selection
- work study/methods analysis
- technological data collection
- metal cutting technology

A considerable amount of work has been done in all of the above areas individually. In particular Arn (29) has provided a most comprehensive analysis of the systems aspects and of co-ordinating the technological sub-system with other systems areas and company objectives in general.

There is also, of course, extensive interface activity between the technological sub-system and the product planning system. Considerable research has been undertaken in this area, dealing for example with the linking of computer aided design with computer aided manufacture (30). Group Technology workers in Europe have been particularly concerned with the technological sub-system and engineering interface (29, 31, 32)

4.2.3 THE MATERIAL CONTROL SUB-SYSTEM

The material flow pattern is probably the broadest and most complex area in the company system and stretches a logical pattern from sales demand through production to distribution. As Bedworth (14) states " ... forecasting, scheduling and inventory analysis provide the heart of the production process." To analyse the material flow pattern in a meaningful manner, one must study the relationship of

- i) the supply/demand co-ordination system
- ii) the material control sub-system

iii) the distribution system

These areas cover, in detail, the following activities:-

Supply/Demand Co-ordination:-

- Short and long range forecasting
- Production programming
- Business cycle control
- Finished product stock control
- Distribution and warehousing

Material flow and resource utilisation:-

- Programming
- Scheduling
- Work-in-progress control
- Lead time and delivery control
- Plant flow system .
 - e.g. line layout
 - group layout
 - functional layout
- Machine and labour utilisation

Quantity control:-

- Finished part stock control
- Quantity planning (co-ordination of manufacturing programme and stock levels)
- Quantity performance monitoring

4.2.4 THE HUMAN SUB-SYSTEM

It has been pointed out (27) that productivity improvement has two roots

- Scientific management
- Behavioural science

The human sub-system which is totally interlinked with the technological and the material control sub-systems deals with the behavioural aspects of productivity improvement and with improving the "effectiveness" of the employee. The key issue in the successful human systems design is motivation, i.e. encouraging the employee to want to improve his performance.

The human objectives involved have been rationalised by H.B. Maynard & Co. from Maslow's (33) and Herzberg's (34) work, supplemented by their experience in group working (27) as

- security
 - safety
 - financial
 - stability of employment
- identification
 - product
 - group
 - work
- self-actualisation
 - achievement
 - responsibility
 - influence
 - personal growth
 - utilisation of skills and knowledge

The technological and the material control sub-systems must be designed in conjunction with the human sub-system to ensure that the

effectiveness potential of employees will be realised. It is exceedingly difficult to measure effectiveness of a plant compared with other plants, and on a national basis wide differences in productivity can be found for minor differences in pay. Factors other than human effectiveness are significant of course, but there is little doubt that motivation and utilisation of human skills are highly important and can yield higher rewards per unit investment than probably any other method of productivity improvement.

4.3 MANUFACTURING SYSTEMS ANALYSIS

Traditionally the design of a production system has started with the specification of the technological aspects to meet a particular product and volume specification. The support tasks (i.e. the decision and information sub-systems), in conjunction with classical organisation theory (e.g. division of labour), have defined the organisation structure. Work allocation and systems specification developed logically from the interaction of tasks and organisation. Human behavioural aspects were not generally considered in such a procedure (Figure 12).

In the "new" approach to systems design, used in this thesis (Figure 13), the heart of the manufacturing systems design is the "production mode". The term is borrowed from H.B. Maynard & Co. (27) and, within the context of this thesis, forms a "blue print" for the systems design, consisting of a broad statement of

- product and market consideration
- work flow
- layout principle

- machine tools and methods
- worker assignment
- organisation
- administrative principles

The production mode defines in broad outline the systems elements and their interfaces. It must satisfy the needs of the corporation, and specifically assist in overcoming existing weaknesses.

The study incorporates the product and volume plans, company policies and strategies, as well as behavioural science aspects and external constraints.

The technological and administrative sub-systems are developed on the basis of the production mode.

Any manufacturing systems study must start from an analysis of company strategy in relation to its objectives, strengths and weaknesses. The strategy will impose certain constraints on the manufacturing system, such as maximum acceptable lead times, stock holding requirements, labour fluctuation constraints, etc. which will significantly affect the basic systems outline.

Skinner (26) states the necessary project steps as follows:-

1. Analysis of the competitive situation
2. Critical appraisal of company skills and resources
3. Formulation of company strategy
4. Define the effects of company strategy in terms of specific manufacturing tasks
5. Study constraints or limitations imposed by the economics of the industry
6. Study constraints or limitations imposed by the technology of

the industry

7. Evaluate company strengths and weaknesses
8. Specify company manufacturing policies
9. Develop the manufacturing system

In a more general vein, Bedworth (14) gives the steps required to analyse and develop systems as:-

- Structure the system
- Determine the key components
- Study the key components in depth
- Integrate key components into a descriptive model of the system
- Apply systems analysis

Bearing in mind the concept of the systems hierarchy (5), the approach of progressively working through the system's levels seems promising, ensuring a modular approach to systems development whilst at the same time giving sub-systems co-ordination at each hierarchical level.

The procedure delegates the analysis of each sub-system to its immediate operating level and avoids the common pitfall of having systems devised by functional specialists, isolated from the operating environment and its personnel. Since each level pre-determines to some degree the operation of the next lower level, analysis across all levels cannot take place in isolation. The highest level must study its system and feed its recommendations and conclusions to its next lower level sub-systems. The sub-systems will develop their systems on the basis of directives and recommendations received, but have the responsibility to feed back analysis results in order to, if necessary, modify the total systems parameters. The top level committee will,

therefore, need to operate for the whole project length as a project co-ordinator. The concept is shown more clearly in Figure 14. Such a procedure will ensure the application of Miles' rule that "... in addition to his own level, a systems designer should think one level up and one level down." (35)

For a manufacturing systems analysis and design, the steps suggested by Bedworth and Miles can be rationalised as follows:-

Step 1 Review current situation

- Competitor and market analysis
- Current systems survey
- Strength and weaknesses analysis
- Economic constraints
- Current objectives and policies

Step 2 Formulate objectives

- Analyse current situation
- State objectives

Step 3 Define the production mode

- State product specification and demand pattern
- Define human aspects
- State environmental, technological and economic constraints
- Develop the production mode

Step 4 Define the administrative systems outline

- Define supply-demand interface
- Review administrative areas
- Relate to production mode
- Relate to human aspects
- Relate to technological system

- Define administrative systems outline

Step 5 Draw up the organisation structure

- Relate to production mode
- Relate to outline administrative procedures
- Relate to human aspects

Step 6 Detail administrative systems specification

- Relate to organisation structure
- Relate to human aspects
- Relate to company objectives and strategies

Step 7 Implement

- Develop co-ordination time-phased plan

Figure 13 shows the relationship of these steps to one another.

5. COMPANY PROFILE

5.1 GENERAL

The ABC Company is a manufacturer of a wide range of hydraulic units such as vane pumps and motors, piston pumps and motors, directional valves, flow, pressure and sequence control valves, etc. The plant dealt with in this study, (referred to as the ABC Plant in the following text), supplies a number of marketing companies in various countries via a Distribution Centre (D.C.) responsible for demand forecasting, distribution and finished goods inventory control.

The business has grown over the last fifteen years through several phases:-

Initially the ABC Company was the only European supplier of a full range of hydraulic units with a high reputation for quality and reliability, making sales volume relatively cost insensitive.

The second stage consisted of a market expansion by setting up wholly-owned marketing companies in most European countries, resulting in increased penetration, notably in small countries.

As competitors broadened their product range and customers became more sophisticated in their product selection, emphasis swung to availability and delivery, requiring the use of local area distributors.

Competitors started to reach comparable technical performance levels and market erosion took place, especially in areas where the company supplied units of older design.

The ABC Company today suffers, relative to its competition, from:-

- i) A limited advantage in price and performance, less than optimum in some specific product areas, allowing competitors, excelling

within narrow product ranges, to compete in areas of their specialities.

ii) Delivery problems due to:-

- limited ability to anticipate and absorb business cycles
- unwieldy internal organisation
- insufficient manufacturing/marketing co-ordination
- long lead-times
- variable manufacturing delivery performance

5.2 THE PRODUCT

The product range produced by the ABC Comany generally breaks up into 13 major product groups such as basic types of pumps, motors, relief valves, directional valves, etc.

The 13 product groups split into approximately 150 family groups, where each family group contains a number of variants of a basic product model.

A vast number of different model configurations are possible within the family groups with 3000-4000 designations normally encountered.

Component complexity tends to be high, with stringent accuracy requirements to meet close specifications. A number of components are specific to the Industry, requiring specialist knowledge in design, testing and manufacture.

Assemblies are, in the main, of low complexity with a small number of parts, ranging from around 10 to 80 parts per assembly, including all proprietary purchased items.

The product life is long and follows the classic demand pattern of slow growth at introduction, growing volumes to maturity and fall-off

into obsolescence.

Mature products hold their market for a number of years and steady volume production, subject to business fluctuations, over 5 to 10 years is common. The need for change can be forecast well ahead, resulting in an orderly, planned product development function with acceptable lead times for all business functions to prepare for new product introduction.

5.3 THE COMPANY ORGANISATION STRUCTURE

Until 1975 the ABC Company was organised on the profit centre basis with the Plant and its domestic marketing function forming one profit centre, and for export, marketing locations making up a number of further profit centres, supplied with products by the domestic profit centre.

Bias in favour of domestic marketing on the one hand and excess concentration on local profit by all profit centres on the other, caused a number of supply/demand problems such as:-

- i) poor customer service, notably in export areas
- ii) high unit inventory in export companies to ensure supply security
- iii) poor forecasting by export companies
- iv) overordering during economic boom to increase pressure for output on plants
- v) massive cancellations in recession to reduce excess inventories

A company reorganisation to overcome some of the problems lead to the split of the domestic marketing company from the manufacturing plant, thus using the plant as a central service, decoupled by a Distribution Centre (D.C.), which is controlled from the divisional headquarter.

The basic organisation structure is as shown in Figure 15. The product planning and distribution function fulfils the supply/demand interface function in conjunction with manufacturing programming which is a manufacturing staff function.

5.4 THE MARKET ENVIRONMENT

The market is split into two areas:-

- industrial (machine tools, etc.)
- mobile (earth moving equipment, etc.)

with the industrial market covering the bulk of the business. The two markets use different products, but common technology. Where possible, a common unit is modified to provide two different versions for each market respectively. There are certain differences in technical specification, quality and cost consciousness in the two markets.

The markets are mature ones, with limited growth potential. Significant growth can only be achieved by increasing market share with the attendant need for improved customer satisfaction.

The proud boast of the ABC Company to supply the whole range of hydraulic equipment imposes an increasing need to excell in all product areas in terms of specification, cost and delivery.

An assessment of the marketing situation based in an internally published review by ABC Company staff showed that the key issues are, with importance weighting factors

- delivery 65%
- pricing 15%
- product performance 15%

Delivery has been plagued by the conflict between demand visibility, lead time and manufacturing lead times.

The strategic situation is characterised by the following factors

- severe price competition
- market erosion
- relatively poor delivery reputation
- strong engineering and quality image
- good back-up service
- world-wide market coverage
- "total capability", i.e. widest product range

5.5. ECONOMIC CONSTRAINTS

The ABC Company is subject to fluctuations in demand, caused by economic cycles of approximately four year average length, but of varying frequency and amplitude.

Since it supplies the capital goods market, the business is several stages removed from the consumer market, and cycles thus show high demand changes due to the amplification of primary consumer demand fluctuations. Figure 16 illustrates this phenomenon by reference to the amplification of consumer demand change to manufacturing investment in the U.K.

The cycles have been more pronounced in recent years and have caused serious problems in tracking customer demand with sufficient accuracy. Labour availability is difficult to adjust and the Company has suffered on the one hand from the need to lay off employees during a recession, and on the other hand from the inability to re-hire to the required level during a boom.

5.6 MANUFACTURING

5.6.1 ORGANISATION

The ABC Company's manufacturing system is organised on a conventional functional basis as shown in Figure 17.

The machine shop manager is responsible for all machining activities including manpower planning but excluding material planning, scheduling and progress. He operates within the constraints imposed by Technical Services and Material Control.

The machine shop is decoupled from the assembly shop by the finished part store. There is no direct link between the machining of component batches and the assembly programme.

Technical Services deals with industrial engineering, plant engineering, phase-in and phase-out of products and special projects.

5.6.2 MANUFACTURING PROFILE

The machine shop produces in-house designed parts only and all other parts are purchased. A number of "in-house" parts are sub-contracted, and these tend to be the simpler components such as small turned parts, simple valve bodies, etc.

As a result of the number of in-house machined parts is relatively low (600) compared with purchased and sub-contracted parts (2500). In-house components generally fall into clearly defined families of similar parts. A typical product group has a small number of complex in-house parts in each of its constituent specific unit assemblies. Taking a typical example of a hydraulic vane pump (Figure 18), the major component families are clearly and visually identified as:-

- vanes and inserts
- rotors
- wear and pressure plates
- rings
- shafts
- bodies and covers

These parts generally re-appear in each vane pump, providing across the manufacturing programme as a whole number of clearly defined component families. The majority of these component families consist of specialised parts, requiring a high percentage of family-dedicated machine tools.

There exists thus a "natural" tendency for the machining activities to fall into manufacturing centres around specific component families.

The sub-contract policy of buying simpler parts has promoted the trend towards a narrow range of manufacturing centres. The 600 in-house parts fall into 12 families of parts, of which 11 form families of closely associated parts with high geometric similarity. Only one family, taking up around 20% of the total machining facilities, forms a mixture of miscellaneous parts (i.e. the miscellaneous valve centre).

5.6.3 PLANT LAYOUT

Not surprisingly, the ABC Plant is largely laid out in G.T.-type manufacturing cells, where generally each cell is dedicated to a family of parts. Thirteen cells are established, of which twelve are component - family - based cells, and one is a general service cell for heavy duty grinding.

Other service facilities for heat-treatment, cleaning and wear-resistant coating are available, and parts requiring any of these services leave their manufacturing cell as required.

The cells vary in size from 3 to 38 direct employees per shift with an average of 8. With the passage of time, certain cells have become less homogenous and there is a significant amount of cross-movement between them.

5.6.4 MACHINES AND METHODS

General purpose machine tools are employed where possible, using component dedicated tooling. The plant is highly automated in the machine shop, but the use of automatic load, unload and work transfer equipment is negligible.

Tooling, dedicated to specific parts, requires extensive change-over times, even between similar components. Eight to twelve hours on specific machines are common, and as a general rule, set-up time tends to be higher for high cost machines. The high degree of automation calls for relatively low operating skills, but high setting skills. Set-up times are currently in the order of 14% of machinery times for a 2 months average batch usage period. Leonard (36) suggests that 10% should normally be a maximum and the 14% figure would already appear to be too high. Any reduction in batch usage times to increase response to market changes and reduce inventory would, therefore, worsen an already difficult situation.

5.6.5 THE MATERIAL CONTROL SYSTEM

The material control system consists of the elements shown on

Figure 19. It is computer-based, utilising Materials Requirements Planning procedures in conjunction with a stock status file which forms the heart of the system.

A stock status file is the only inventory record for finished part stock. The input consists currently of:-

- 6-months firm orders from the D.C. by specific unit designation, updated monthly
- 12-months forecast by family group, updated quarterly
- stock losses, scrap, unplanned additions
- receipt of completed works/purchase orders
- assembly draw-off schedules, removing parts which are to be assembled from the stock record, and removing corresponding orders from the projected customer order line on the file
- input of spares orders by part number

A manual system is used to control raw materials.

A material records section interprets the stock status report and issues purchase requisitions for finished parts to machine shop control and purchasing respectively with indicated due dates.

Machine shop control raises shop orders through the computer. The computer calculates start dates by back-scheduling to infinite capacity from the due date, using standard wait and move times between operations.

Works order documentation is issued automatically prior to calculated start date when material availability has been confirmed.

Machine load priority lists are printed by the computer to calculated priority rules.

Completed and "diverted" parts (i.e. unplanned losses and gains)

are logged daily for all batches worked on, to update open works order and stock status files.

Customer orders are accumulated in a "current order" file and, by explosion through a bill-of-material file, entered on the stock status file.

Assembly build lists are raised weekly from the current order file.

Build and shipping documentation and stores picking lists are printed automatically by the computer. The stock status file is automatically reduced by the build programme, both on the current order, and the theoretical bin line respectively. The assembly work-in-progress file is updated.

The major systems elements are illustrated in block diagram form in Figures 20, 21 and 22.

5.7 CURRENT PROBLEMS

5.7.1 DEMAND FLUCTUATIONS

The ABC Company had by and large found it difficult to deal with its cyclical economic environment. Forecasting had been ineffective and had failed to provide a reasonable manufacturing planning guide. Manufacturing personnel were inclined to "second-guess" the forecast, and that procedure no doubt lead to some amplification of demand fluctuations.

Manufacturing lead times were bound to contribute to this amplification (16) and the long lead times and poor forecasting performance could probably explain to some degree the delays in meeting demand changes, the poor customer satisfaction in a boom and the high

inventory in a recession.

In previous booms, the ABC Plant was overloaded, causing shortage of supply for certain key parts where capacity constraints existed. This led to poor delivery performance to schedule, high finished parts inventory due to stock mismatch, and high progress effort which was ineffective, since it could not overcome the inherent problem of capacity shortage.

In a recession, many orders which could not be supplied or where scheduled on long lead times, were cancelled, causing an accelerated demand fall-off and hence over-capacity. Delivery performance was poor as a boom approached and the assembly back-log due to key parts shortage increased.

In many ways the old system of producing parts to forecast and assembling to order, appeared to be sound. With poor forecasting capability, however, the finished part stock lost control and manufacturing were criticised. Whilst the new method of decoupling supply from demand overcame problems of accountability, it caused stocks to be held at their highest value (i.e. fully assembled and tested), and was expected to cause problems of dealing with product mix changes in the future.

The material control system described was basically an inventory control system with material requirements planning to determine order quantities. There was no direct link between machine shop batches and assembly programmes and thus the effect of parts shortages could not be easily translated into overdue unit builds.

There was no parts implosion facility to re-schedule work relative to delays in key parts delivery such that all affected parts could be re-scheduled. Indeed, to do so would have been exceedingly complex in

the general batch production, inventory control system.

5.7.2 PRODUCTIVITY

It was claimed by ABC Plant staff, that labour standards were based on low volume quantities, established during product start-up. The hypothesis seemed to be substantiated by exceptionally high operator efficiencies, suggesting inflated standards in use.

It was further claimed, that production control suffered from mis-match of computer records due to lack of standard data during products start-up for long periods of time. This was said to be caused by a reluctance in Industrial Engineering to issue standards until time returns from early batches on the shop had confirmed (or otherwise) estimated times.

Standards therefore seemed to be based on start-up values, with high learning losses and low batch size cost inflation.

Comparison with other group plants suggested that product costs were high, both in terms of direct labour costs as well as overhead cost. Bearing in mind that labour rates were low in the ABC Plant, there appeared to be a significant productivity improvement potential.

There were no motivational means available at present to develop productivity improvements outside the traditional industrial engineering field, and no method of measuring overhead labour effectiveness, hence no judgement could be made on the overhead cost saving potential of the plant.

The latter problem was accentuated by the existing functional organisation structure. Considerable communication cost existed. Whilst the computer systems employed were comprehensive, they provided

a wide range of tabulations which required attention. Documentation flow across departmental boundaries was significant and time consuming.

5.7.3 SET-UP COST

As indicated earlier, setting times were high and no economic batching as such was used. Batch usage periods with economic batches would have been too high and would have caused excessive inventory levels and high lead-times.

Some degree of economic batching took place by subjective comparison of setting and machining times. Several months' requirements were at times combined into one batch. Such procedures will, of course, cause load fluctuations in manufacturing cells unless they are carefully planned and thus, firstly require a certain level of work-in-progress to smooth capacity and, secondly, promote a variable batch throughout time, roughly proportional to the centre load at any one specific time.

The observed average cycle period in the ABC Plant was 2 months, compared with an average economic usage period of 3.3 months. Thus average batch sizes were 40% less than economic batch quantities and any attempt to reduce them would have worsened this situation.

In order to cut lead times and to reduce inventory levels, loading cycles needed to be reduced to a minimum, but to do so, means of reducing set-up times to a minimum had to be considered. The ability to respond to market fluctuations hinges to a significant extent on the ability to produce parts in small batches.

5.7.4 PARTS LOADING AND SCHEDULING

The existing machine shop scheduling system tended to promote late

machine shop delivery. Batches were back scheduled from due date, assuming infinite machine capacity, from a due date on the first day of the requirements month. Thus on latter operation machines in a work-centre, high demand fluctuations were expected with heavy overloads as the month end approached, such that late delivery could not generally be avoided. Wait and move times of one day were used, which are short by industry standards unless a G.T.type flow pattern is introduced. Thus there was little slack in the system to absorb the fluctuations and the ten day slack allowed at the end of each schedule was insufficient to absorb queuing delays. The situation suggested problems of poor average machine utilisation to be able to accommodate the highest possible amount of load fluctuation, and poor machine shop delivery performance, worsening as demand increases. Both hypotheses seemed to be fulfilled in the plant.

A very small sample of batches and machines were surveyed during approximately three months, to get a better understanding of the scheduling effectiveness. Figures 23 to 27 show graphs of the backlog for some of the machine tools reviewed.

The production scheduling system distinguished four batch planning levels:-

- i) running - issued to machine
- ii) available - ready to run, all previous operations complete
- iii) pending - previous operation not yet started or completed, but all earlier operations completed.
- iv) planned - remaining works orders issued

Level (iv) was a longer term plan with many later changes and

cancellations. Thus only levels (i) to (iii) have been considered in aggregate for the analysis.

The two graphs on each figure indicate for the machine concerned,
 i) solid - mean negative priority of late batches calculated at

$$\frac{\sum(\text{Batch quantity} \times \text{days late})}{\sum(\text{Batch quantity})}$$

for all batches running, available and pending. Days late are relative to planned schedule, including theoretical wait and move times.

ii) dotted - percentage of batches late, relative to all batches listed as currently running, available and pending.

The graphs confirm the general tendency for the majority of batches to run late, and indicate the serious level of average lateness.

There appears to be a tendency for lateness to increase with the increase in percentage of batches running late. Thus increasing percentage lateness seems to indicate true bottle-neck conditions, with all batches slipping back, i.e. on-time batches moving into overdue and already overdue batches worsening their situation.

The situation seems to run to some degree parallel across the shop. Thus, for example, around weeks 8 to 12 there seems to have been a general lack of work on most machines with a significant build-up of work afterwards.

The fluctuations do not indicate a monthly pattern of overload as one might have expected. There are, however, so many disturbances, that it is difficult to detect the specific monthly pattern, and the high overdue condition causes overloads to persist over longer periods.

The problem is no doubt accentuated by the fact, that works order issue was not matched to available capacity.

Figure 28 shows the weekly works order issue level over a 19 week control period. The graph show the significant variation in order issue level, which must reflect itself in machine load levels.

The problem was aggravated by insufficient allowed lead times for re-ordering. Orders were triggered from the stock status report within the lead times specified for each component. Table V shows some typical examples of batches loaded on the shop, where for eight batches, six required machining plus administrative lead times in excess of those predicted in the stock status report. There was thus a tendency for batches to start late, causing continuous pressure to expedite.

The average machine utilisation (setting plus machining hours at standard to available hours) was only in the order of 30 to 35%. This figure is low by national standard (37), and even in a boom it did not exceed around 50 to 60% when severe bottlenecks occurred. The poor average utilisation was probably to some degree caused by the layout into component family manufacturing centres, but since the plant was not run on G.T. lines, the high level of fixed assets was not offset by a low batch throughput time and hence low productive inventory.

Typically over 50% of all batches in the machine shop were running late and bin levels on the stock status report showed a high percentage of low (i.e. below safety stock) or negative (i.e. shortage) value. In a review of a typical month of in-house made stock items, on the stock status report, it was found that 27% of all items showed a lower than acceptable bin level, with 12% positive but below safety stock and a further 15% negative. The 15% reduced to 8% for the

first month after stock status report issue. 3% of these 8% were due to exceptional demand, i.e. a first month demand only, probably due to a spares order. The stock status file is designed to show all currently overdue batches as available in the first month after report issue date. The "true" shortage was thus only around 5%. The fall from 15% current bin shortage to 5% in the first failure month seemed to confirm that delayed shop orders make up the bulk of the shortages.

Of purchased and sub-contracted items, only 10% showed a low bin. The purchased parts availability was, therefore, better than in-house parts availability, but stock levels were correspondingly higher.

In-house parts stocks were generally kept in line with the theoretical minimum stock. Since complete stock balance was not achieved, a higher than optimum stock for certain parts was offset shortages in other parts.

5.7.5 MANUFACTURING LEAD TIMES

Short lead times are required to

- a) minimise amplification of demand fluctuations
- b) reduce the forecasting horizon
- c) increase the number of units which can be built to firm order
- d) reduce the danger of customer order cancellation after work order issue

Lead times existed in the ABC Plant as:-

- material procurement
- in-house machining
- assembly and test
- administrative

Administrative lead times can vary significantly and are based on the timing of orders in relation to the systems cycling. There is normally some reduction possible for high priority items, utilising safety stocks.

If lead times are to be reduced in a tightly controlled environment, there are principally five strategies:-

- Use high buffer stocks for materials and purchased parts
- Tighten up supply reliability
- Reduce machine shop throughput times by suitable loading and scheduling, maximising operation overlap
- Reduce assembly and test lead time by reducing administrative time and improving flow
- Reduce administrative losses by improving administrative procedures, reducing the effect of data processing, and coupling machining and assembly into joint scheduling activities.

The question of administrative lead time deserves further discussion and is a factor which is frequently ignored when order lead times are discussed.

Three types of administrative lead times can be distinguished:-

- i) systems delays
- ii) cyclical delays - data processing
- iii) cyclical delays - production planning

Systems delays are simply the paperwork delays in information flow, dealing with the generation and issuing of a works order from a customer order input. Seven movements between departments were involved in the Plant before the order was issued to progress. Each transfer had a finite delay period. The flow may be likened to multi-

operation parts processing with wait and move times between operations. The total "processing" time can be reduced by concentrating the activities into a smaller number of "operations" and hence cutting wait and move times.

Cyclical data processing delays were caused by the need to wait for the next processing run. Thus if a certain programme (e.g. works order generation) was run weekly, an average delay of half a week could be expected. The problem is present wherever data processing operates in a batch mode and the trade-off between processing cost and waiting cost is a significant decision in systems design. Sequential processing compounds the problem, of course.

A typical production planning delay was the machining/assembly buffer period. All parts were scheduled for stores receipt on the first day of each assembly month. Assembly was spread evenly across the whole month, however, such that on average parts waited for two weeks.

Table III shows a summation of average lead times in the ABC Plant:-

Administrative)		
)	4.7	weeks
Data processing)		
Material procurement		18.0	weeks
Internal manufacture		<u>10.7</u>	weeks
Total :		33.4	weeks

It is appreciated, of course, that these were average values only and could vary significantly for specific units. Since assembly was held up waiting for the longest lead time parts, actual throughput time would be governed by the longest lead times, rather than the average.

5.7.6 SAFETY STOCK

Where average demand remains static, a safety stock can accommodate fluctuations and urgent orders, but if demand increases progressively, say in an economic boom, safety stocks will soon be depleted.

The machine shop lead times of planned average 6.7 weeks were not achieved in practice and assembly draw-off for parts was mainly out of safety stock, which was replenished when late batches were received. The safety stock thus acted as a buffer for scheduling delays and not as a means of dealing with unplanned losses or demand changes. To be able to absorb demand changes better, it was therefore necessary to either increase safety stocks or improve machine shop delivery. Safety stocks were recalculated monthly as a function of forecast future demand. Thus safety stocks promoted amplification of demand changes.

5.7.7 SUMMARY OF MAJOR PROBLEMS

- Demand fluctuations
- Less than acceptable productivity
- High set-up cost
- Lack of capacity balancing
- Variable machine shop delivery
- High administrative delays
- Inadequate safety stock calculation
- Lack of machining-assembly cycle matching

6. ANALYSIS

6.1 BUSINESS CYCLES

A business operates within a total national or international economy. World economics are subject to business cycles, where product demand fluctuates in a cyclical manner of varying cycle frequency and amplitude, and it has been stated, that "Business cycles have been an uncomfortable illness of economic life in Britain for years" (38). Major and minor cycles have been identified (39) where major cycles may typically be 8 to 10 years in length with minor cycles interspersed. 4 - 5 years has been a typical cycle length since the second world war, including major and minor cycles. The frequency is variable, however, and cannot easily be predicted.

Forrester has shown (16), that cycles are amplified in a dependent supply chain, as activity is further removed from the source of change. The ABC Company had little influence over its customer order intake and, subject to levelling marketing strategies, had to accept the order intake fluctuations as they arose. The two problems were, that firstly, there was a need to forecast demand changes to adjust resources in good time, and secondly, that varying output had to be reconciled with a significantly fixed resource input.

Dealing with forecasting first, it is known that:-

- i) a forecast is always wrong (40) and
- ii) forecasts are more accurate for short periods of time ahead (41)

Thus, to promote greater forecasting accuracy, short manufacturing lead times are required.

Forrester's analysis (16) shows the lead time is a significant amplifying factor in a system, and if demand fluctuations are not to

be increased internally to a significant degree, it must be ensured that internal lead times are short.

Figure 29 shows the recent pattern exhibited by the ABC Company during one cycle, comparing

- customer demand
- plant shipments
- manufacturing

The currency figures are inflation corrected.

True comparison of amplification trends is difficult, since the unit shipments from the Plant and standard hours generated were only available as annual totals. The scales have been chosen such that all graphs approximately coincide.

It can be seen, that Manufacturing attempted to respond closely to order intake, particularly to the high peak in year 4, but shipments of units were considerably smoothed out. It is known, that inventories built up during year 4 and year 5 due to stock mismatch (i.e. selective bottlenecks), and customer cancellations. These inventories were used up to some degree in year 6, causing a marked amplification of the shipment downturn in the manufacturing area.

There was clearly a need for good forecasting and some degree of inventory build-up in the recession to meet the occasional peak demand shown in year 4. Certainly, in a long lead time system there is no justification in attempting to follow the sharp peaks with manufacturing input. Either orders must be rejected, or a proportion of peak demand must be met from stock.

The graphs show that no gain was obtained from following the year 4 peak. The manufacturing output was allowed to fluctuate dramatically, but shipments to the customer did not track the high

demand surge.

There can be little doubt that lead time is a significant business cost factor affecting:-

- labour market goodwill
- customer goodwill
- shipment levels
- capital requirements

It is not possible to quantify the cost of lead time without prolonged study, but it may well be a greatly neglected factor of systems effectiveness for a company operating in a cyclical environment. The following paragraphs illustrate some of the effects of lead time in the manufacturing system.

For a manufacturing plant, converting material into goods, with a sinusoidal order intake pattern, the input /output graphs are as per Figure 30(a). ϕ is the total order throughput time (raw material provisioning + machining + assembly etc.) If the phase lag ϕ is large, it is likely that orders will change during the lag and shipments may differ from original orders with the difference going into or coming out of inventory. If orders are related to the current trading position, order amendments and cancellations are likely, hitting the company two ways: during a boom the plant will prove to be unable to meet the peak and during a depression cancellations will ensure that the depth of the trough will be reached.

The likely pattern will be as per Figure 30(b). Average shipments are depressed and costs are high since capacity for the peak demand has been provided. Inventory fluctuations are high, absorbing the difference between goods produced and goods shipped (shaded area,

Figure 30(b).

By high inventory holdings, the position can be corrected (Figure 30(c)). The inventory buffer is a function of ϕ and hence the greater the phase lag, the greater the inventory buffer.

For economical cyclical planning of manufacture, a short order throughput time is therefore essential.

A useful strategy may well be to maintain high stock levels for raw materials, where lead times are largely outside the Company's control. For in-house manufactured parts, absorbing usually a higher percentage of product cost, a short throughput time system should be designed to minimise phase lag ϕ .

It has been claimed that for the ABC Company the maximum delivery period demanded by the customer is generally less in a recession than in a boom. There is thus in a recession a need to:

- a) meet orders at short notice
- b) have either a short order lead time or a substantial stock
- c) either make for stock or lay off labour

There is little doubt that the correct strategy is to use the recession to build up stocks. Apart from the need to stabilise labour requirements, the strategy satisfies the need for quick delivery. Furthermore, a previous ABC Company study has demonstrated the economic benefits of balancing stock holding cost with additional sales by satisfying peak demand more effectively than in the past.

There is, in any case, a trend towards employment stability on the Japanese model, making hiring and firing economically or legally impossible as a business strategy (42). The term "labour, a fixed asset" has been used in the press (43) and this trend must be

considered in long range capacity planning. Even in the U.S.A., there are now moves towards complete job protection(44).

Much is to be gained by stocking parts and widely used sub-assemblies, but accepting demand fluctuations in assembly and test to overcome the problem of forecasting future mix by specific unit designation.

Assembly and test times in the ABC Company were only in the order of 20% of total manufacturing time. If, say, output increased by 30% and machined parts are already available, total labour needs only to be increased by 6% to accommodate the increase. Thus a basic strategy to make parts and general sub-assemblies for stock in a recession appears to be sound. The strategy does, however, require the availability of spare assembly and test equipment capacity to meet demand of peaks.

There are problems of defining a mean demand line against which to fix the cyclical planning level. Regression analysis combined with econometric forecasting is required to ensure that the smoothed manufacturing line does in fact reflect the mean demand line. If the mean line is missed, problems of cumulative stock growth may occur.

The cyclical planning concept is further advocated to overcome the problems of forecasting demand which fluctuates approximately sinusoidally with varying amplitude and frequency. A number of forecasting techniques are available but these generally fail to deal with varying, low frequency sinusoidal changes.

Seasonal trend adjustment (41) is possible but requires a known frequency of demand change, which is not available in economic cycles. It is claimed by marketing staff in the ABC Company that econometric forecasting of business cycles is difficult in the prevailing

environment and that previous attempts have failed to provide meaningful indicators.

It has been suggested (45) that the levelling of business cycles is essentially a governmental duty, but there must within each company be a conscious effort to minimise internal amplifications, which are subsequently passed down to the next member of the supply chain. A business must be seen as just one element of a larger economic system. Companies can no longer be treated in isolation and must be accepted as part of a larger world-wide systems hierarchy. There is thus a strong moral obligation in enterprises to minimise demand change amplification.

6.2 PARTICIPATIVE MANAGEMENT

Any up-to-date discussion of manufacturing systems will be strongly influenced by the human aspects of management. Modern research has indicated that the organisational and motivational principles of industry are changing. The concepts of participative management require different, and often much simpler, management systems. A change from a conventional organisation (e.g. Likert's System 2 or 3) (24) to a participative organisation (e.g. System 4) will have such far-reaching effects on the administrative and work flow systems, that human aspects move to the forefront of production mode specification.

Apart from the strong claims made by Likert for the economic benefits of his "System 4", trends in Europe show clearly the continuing pressure for increasingly participative management (46, 48), and there is a growing need to adopt our democratic political

thinking in the work place (48).

As Forrester (49) points out, "New thinking in the social sciences indicates that moving away from authoritarian control in an organisation can greatly increase motivation, innovation, and individual human growth and satisfaction." "Critical examination of trends in the structure and government of corporations suggests that the present superior - subordinate basis of control in the corporation should give way to a more constitutional and democratic form."

Major arguments for greater participation are (48)

- the promotion of satisfaction and personal development of the worker
- the extension of democracy
- as a means of improving industrial relations
- as a means of increasing efficiency.

If participation can achieve some degree of success in any one of these objectives, it will have been worth developing. Profit sharing has been one approach used by companies, but by and large has not been too successful (48). Consultative committees have been used extensively but, because management has used these as informative, rather than participative bodies, have only had limited success. It is claimed, that a new approach to organisation design is required, which provides a base for real delegation of decision making and worker participation in the operational aspects of the enterprise (24).

The modern trend is towards group contact, rather than person-to-person contact, and group decision making. Whilst the supervisor retains the responsibility for his group's decisions, the decision making process is based in group discussion and the key aspects of

Likert's "System 4" organisation are:-

- i) group decision making, and
- ii) a multiple overlapping group structure

The key motivator is the group loyalty, which will cause each member to support the group's objectives. As Likert puts it:-

"The highest productivity, best performance and highest earnings appear at present to be achieved by "System 4" organisations. These organisations mobilise both the non-economic motives and economic needs, so that all available motivational forces create co-operative behaviour focused on achieving the organisation's objectives." (24)

Bowey and Connolly (50) discuss the problem of the lack of motivation amongst supervisors, managers and professional specialists in Britain, and suggest an organisation based on groups of these employees. The concept, which owes much to Likert's concepts, is based on the establishment of dual group membership for these employees. Thus supervisors will be members of their manufacturing centre on the one hand, and members of a supervisory group on the other. "In order to apply this concept of self-organised group working to supervisory levels, the work of each group of supervisors would need to be amalgamated into a joint task for which they would be jointly responsible" (50).

6.3 THE FEDERAL ORGANISATION

There is a tendency in companies to base their formal organisation structure on the principle of functional specialisation, going back to Adam Smith's division of labour. Indeed, the functional organisation structure has for so long been the dominant organisation

principle, that the great majority of industry is arranged in such a manner.

In modern theory, the elements of an organisation have been defined as (6) :-

- goal orientation (purpose)
- psychosocial systems (groups)
- technical systems
- integration of structured activity

It is only in recent years that the need to integrate these four elements has been fully recognised. Previously the "classical" organisation theory (13) was characterised by its virtually sole pre-occupation with structural and bureaucratic aspects such as functional division of labour, a logical structure of relationships and the concept of span of control.

The classical theory purposes the bureaucratic form of organisation and develops from Adam Smith's early concept to Brech's modern re-statement (51), where organisation is concerned with the definition of:-

- a) the responsibilities of the executive, supervisory and specialist positions into which the management process has been subdivided; and
- b) the formal inter-relations established by virtue of such subdivided responsibilities.

The division of line and staff influences this kind of organisational theory strongly, where functional staff is closely interwoven with operational managers and where in many instances the lines of responsibility are difficult to define.

The "classical" organisation theory has been augmented by the knowledge that human behaviour needs to be considered in the organisation. Whilst this did not initially affect the specification of organisation structures, the "neoclassical" (13) organisation theory did recognise the existence of the informal structure and the need for managers to balance the needs of the formal with those of the informal structure, as illustrated in the Hawthorne Experiments (52).

In the modern organisation theory, the systems aspects of the organisation are recognised, with the need to integrate its separate elements into the formal structure. It is realised now that "... work cannot be effectively organised unless the psychological social and physiological characteristics of people participating in the work environment are considered." (13).

The demands on the organisation are more difficult to meet in the modern business system, and the key characteristics have been listed at (6):

- growing size
- complexity
- multinational operations
- specialisation of skills
- diversity of objectives
- meeting change
- external demands

The rigid bureaucratic organisation is unable to cope with these characteristics and a more adaptable, task orientated structure is essential. The traditional concept of span of control illustrates the problem.

There is said to be a maximum span of control for each supervisor, limiting the number of people he can effectively supervise and co-ordinate. This span of control varies with the quality of the supervisor, the quality of his staff, the task complexity, etc. The limit is not fixed, and indeed is hard to define for any one system; though to give an indication, figures ranging from 3 to 30 have been mentioned(53).

The span of control determines the number of management levels in a company, which, assuming for arguments sake, a fixed span of control of 12 people at each management level, can be shown to be three levels for a plant of 500 people (Figure 31). 42 first line supervisors need to be co-ordinated through two higher management levels. The co-ordination can become exceedingly complex, and leads to the apparent lack of manageability found in many manufacturing plants today. The problem did doubtlessly exist in the past, but was probably not as significant. In recent years, however, Industry has become more competitive, requiring better co-ordination of economic performance objectives.

The functional organisation thus leads to a proliferation of tasks within one system, resulting in poor manageability and high overheads. Using Skinner's concept of the "Focused Factory" (54) there is a need to focus on a narrow range of tasks in the manufacturing system. Assuming that one does not wish to materially change the external business environment, it is necessary to split the organisation into largely self-contained units, each one with a narrow objective range.

It is, however, possible to utilise the concepts of primary psychological groups of 8 to 10 people (55) and group working to

establish a simpler organisation structure, which, whilst not necessarily reducing the number of supervisors, improves manageability by focusing individual groups' efforts on specific and complete tasks, with reduced linkages between them.

Throughout history, groups of this size have been found and are characterised by an inter-connection of personal relationships, and clearly defined attitudes and rules of behaviour for members (56). Schein states that, "For example, a formal work crew such as is found in industry or in the Army (say a platoon) often becomes a psychological group that meets a variety of psychological needs mentioned. If this process occurs it often becomes the source of much higher levels of loyalty commitment, and energy in the service of organisational goals than would be possible if the psychological needs were met in informal groups that did not coincide with the formal one" (57).

Research into G.T. has high-lighted the beneficial effect of creating primary psychological groups around common tasks, and make the formal work-group common with the informal primary group, such that the moral strength of the group is directed towards the same aims as the company objectives.

Brown (55) argues that "All psychology is social psychology, and, without denying the existence of the superego, it is believed, that the major instrument of social control is the primary group". In a functional organisation primary groups will generally form within functional departments, and business systems rely on the co-operation across group boundaries to achieve co-ordinated performance. Inter-group rivalries are likely to form, compounded by functional parochialism, and poor task identification beyond group boundaries.

As Drucker discusses, "Every functional manager considers his

function the most important one ... " "Its objectives will therefore tend to be set in terms of 'professional standards', rather than in terms of the success of the business. They will tend to direct the attention and effort of managers away from business success, rather than toward it - will tend, too often, to emphasize and to reward the wrong things (1)".

The concept of 'Federal Decentralisation' has, therefore, become more popular in recent years (Drucker quotes General Motors, Ford, Chrysler, General Electric, Westinghouse, etc.) where the total business is split into autonomous product groups.

The term is applied to the split of a business into major product divisions, which jointly make up a "federation" of subsidiary businesses. The term "Federal Organisation" is used as an adaptation of Drucker's terminology in the subsequent text to denote the split of a plant into significantly independent "operational modules", which jointly make up the manufacturing system.

There is evidence available in a study by Beer (58) that job satisfaction is a function of organisation size. The reasons suggested for decreasing job satisfaction with increasing organisation size are:-

- high division of labour
- poor co-ordination
- bureaucratic inflexibility
- communication problems

The argument of detrimental size effect is supported by Revans (59), who coins the term "tendency to vertical disruption", a phrase particularly apt for the large multi-level functional organisation.

There appears, therefore, from the motivational standpoint, to

be a need for smaller operating units, and one may surmise that it is feasible to group a number of such units under one roof and still minimise the problems of large organisations, if each unit can be kept significantly, if not totally, self-supporting.

There are limits to the concept of the federal organisation, where a range of products is combined into a supply "package" requiring common engineering, and marketing effort. Indeed, there appears to be no reason why federal decentralisation must be developed to the same level in each activity area. The overall company split into Marketing, Planning and Manufacturing, based on conflict resolution, can overcome many of the problems of functional specialisation where decentralisation within products becomes unacceptable.

Where, as in the ABC Company, federal decentralisation is not applicable to Marketing, the areas of Engineering and Manufacturing can be split by product, with the burden or co-ordination thrown onto the planning function. The concept is illustrated in Figure 32, demonstrating for Product Group 'A' a decentralisation of the Marketing function in terms of market area, and of the Manufacturing function in terms of product families. One can visualize the concept in terms of three manufacturers supplying two retailers via a wholesaler (i.e. supply/demand co-ordination).

The task of adequate objective optimisation falls on the supply/demand co-ordination function which, by means of suitable stock control, forecasting rules and capacity allocation balances the conflicting requirements of manufacturing and marketing.

If one considers the production program determined by the supply/demand co-ordination function as the order input into the manufacturing function, the "orders" can be split over each decentralised

product-family-based manufacturing unit to effectively treat each unit as a separate system in its own right.

Taking the concept further, each product family manufacturing sub-system can be split into, say

Machining

Assembly

Test

The machining can be split into separate facilities, arranged around component families, where each manufacturing cell is responsible for the supply of a specific family of parts. If these manufacturing cells are set up in small enough size, to form primary psychological working groups, the manufacturing system will be arranged in a largely non-functional manner into significantly autonomous working groups allowing the formation of operational activity such that primary psychological groups can be common with work task groups.

By decoupling machining and assembly with a suitable finished parts buffer store, additional assembly groups can be formed.

In its simplest form the concept is illustrated in Figure 33. In simple manufacturing environments, it may even be feasible to combine machining, assembly and test into one work centre, but normally for assembled products the machining group to support assembly is likely to be too large to utilize the concept of primary psychological working groups for the total product centre.

The organisation can, therefore, be based on operational "modules" incorporating on a small scale functional specialities. In the modern business environment, the range of specialist skills may be wide, and the concept of establishing these skills in a considerable

number of small operational units may not be feasible. It is, thus, necessary to:-

- a) Limit the skills required in each cell by developing units within narrow ranges of product component diversity.
- b) Set up central staff services to firstly support operational units with specialist services, and secondly provide development and training facilities for new techniques.

Each operational module should, however, be an integrated business system with clearly defined objectives, relating to the business as a whole, where external staff services act as advisory/service activities, utilised by the line supervisor to enhance his performance. They should not be able to overrule the supervisor and thus detract from his performance accountability.

Walker and Lorsch (60) suggest that any organisation exhibits characteristics of differentiation (i.e. the difference in behaviour and attitude between functional specialists depending on their training and expertise) and integration (the co-ordination of different activities towards common goals). The problem of organisation design is to accommodate the conflicting requirements of differentiation and integration in relation to the task and this aspect affects the choice of functional versus product organisation. A case study (60), comparing two such companies showed that the functional organisation showed high differentiation and low integration, causing problems for functional specialists to identify with line manager's objectives. A product organisation showed high differentiation in time orientation (i.e. functional specialists concerned themselves with long term issues and line managers with short term activities) but lower differentiation in goal orientation. Conflicts in the product organisation were not

pushed up the hierarchy but were resolved at lower levels. Better integration was achieved due to better communication and improved conflict resolution.

The following questions are suggested for the choice between a functional and a product organisation:

- "1. How will the choice affect differentiation among specialists? Will it allow the necessary differences in viewpoint to develop so that specialist tasks can be performed effectively?
2. How does the decision affect the prospects of accomplishing integration?
3. How will the decision affect the ability of organisation members to communicate with each other, resolve conflict, and reach the necessary joint decision?" (60)

Relating these questions to the federal organisation structure discussed previously, the need to distinguish clearly between operational personnel and functional specialists becomes more apparent. By making line managers responsible for narrow, closely ordered activities, a very high degree of integration is achieved within each manufacturing centre. The need of co-ordination between manufacturing centres is limited and can be easily achieved by first line management. The small size of each product group makes integration simpler in any case.

In the specialist areas where high differentiation is required, the activities will have poorer integration with operating personnel. The problems can be overcome by encouraging close communication through the specialist activity committees. In the Company discussed, specialist knowledge in the service areas needs to be high to cope

with the advanced technical complexity of the operating environment. High differentiation thus needs to be maintained and it is unlikely that operating personnel could absorb the depth of knowledge required in specific areas to eliminate the need for specialist departments.

The well known G.T. users Serck Audco have used the concept of "miniature factories" (61) inside their plant, where each manufacturing cell is issued with a work schedule, matched to known available capacity and the corresponding material. Frustration is resolved by pre-matching capacity and not issuing work unless material is known to be available. Having cleared the resource input problem, the centre has full control over work execution.

It is this aspect of control which can only be properly accommodated within a small task orientated unit. Any manufacturing system is concerned with "multi-system control" (62) and it is unreasonable to expect managers to respond to conflicting requirements without understanding the overall objective profile. As Reeves and Woodward (62) state, "... the supervisor's main task is to violate each of the standards as infrequently as possible. Furthermore, he will presumably rank his goals in a diminishing order of nuisance value... Only a small operating frame with clear business-related objectives is likely to yield an acceptable performance level."

The small group size also facilitates the effectiveness of the two main systems regulators, i.e. monitoring and boundary control (63). Systems monitoring relative to company objectives is notoriously difficult in functional organisations, but is likely to be simple for semi-autonomous groups, where problems can be pin-pointed to a specific small area within the overall business system. Boundary control is reduced to simple input-output monitoring, greatly simplified

by the drastic linkage reduction in a significantly closed, task-orientated sub-system.

It is likely that the tendency of disproportionate growth of administration with organisation increase (58) can be retarded if the control and co-ordination complexity of the system is significantly reduced.

March and Simon (64) claim that "the balance of net efficiency shifts from process to purpose organisation as the size of the organisation increases." They discuss the difference between individual and group specialisation, supporting the establishment of task groups, but indicating the problems of functional group co-ordination of extensive group interdependence exists.

6.4 EFFECTIVE PERFORMANCE

6.4.1 FACTORS IN EFFECTIVE PERFORMANCE

The following key factors relating to effective plant performance can be recognised:-

- Personnel effectiveness
 - motivation
 - task identification
 - objective performance measurement
- Technical effectiveness
 - plant and equipment
 - personnel skills
- Utilisation
 - asset utilisation
 - labour utilisation

Considering each factor in turn, their inter-relationship can be analysed to lead to a rational development of an effective production system.

6.4.2 MOTIVATION

Claims made by various writers seem to indicate that the human systems element requires a much higher degree of attention than has been provided in the past. From the initial research in the Hawthorne experiments to more recent concepts such as Likert's "System 4" or Blake and Mouton's "9.9 Managerial Style" (65) a high positive correlation between motivation and productivity is indicated, irrespective of the improved quality of life which these people-based management styles may provide. Brown (55) indicates that human effort is largely controlled by task motivation which may well be much more significant than the technologist realises.

Herzberg (34) distinguishes between "job satisfiers" (motivators) and "job dis-satisfiers" (hygiene factors) in his analysis of factors affecting job satisfaction. The hygiene factors, which are largely physiological (company policy, administration, supervisory, salary, inter-personal relations, relations to supervisor, working conditions) govern the degree of dissatisfaction, but will not actively promote satisfaction except, perhaps, for a short period (e.g. salary increase). The motivators are of a psychological nature (achievement, recognition, work itself, responsibility, advancement). They will not in themselves cause job dissatisfaction, but they, and only they, will produce job satisfaction of a lasting nature.

Job satisfaction, therefore, deals with two levels:-

- a) setting the correct physical environment
- b) providing the correct psychological environment

There is no doubt that a satisfactory psychological environment can often overrule shortcomings in the physical environment, but, as Herzberg points out, no improvement in the physical environment can make up for shortcomings in the psychological environment. Aspects of the physical environment are well understood these days, and generally, enlightened companies make a deliberate effort to satisfy hygiene factors.

For motivators, the interaction is not as simple. H.B. Maynard & Co. list the key motivators in a production environment as:-

- self-actualization
- group identification
- product/work identification

Self-actualization in a functional environment is difficult where the scope of activity is limited and narrow, and the emphasis is on the amount of useful work produced, rather than on the satisfaction this work may produce. Recognition and achievement are low since the task is simple, and is known to be so by the executor and his supervisor. There is hardly any room for professional or self respect on the basis of a single repetitive task.

Opportunities for advancement are limited, due to the narrow range of acquired skills, and often the more capable members will seek recognition outside the company (vocational activities) or through internal activities where a significant part of their effort and skill may be used contrary to, rather than in support of company objectives.

At this point one should remember that job enlargement must be looked at in two dimensions, horizontal growth (commonly known in fact, as job enlargement) and vertical growth (job enrichment) (66). There is a particular need to ensure that the latter is considered in a human systems design, to ensure that satisfaction of the self-actualisation need is promoted. It is likely that job enlargement without job enrichment will lead to higher stress and frustration, but do little for increased self-actualisation.

There is some dispute in studies (34), if "inter-personnel relations" is a hygiene or a motivation factor, and work in G.T. and group working seems to indicate that close social contact in primary psychological groups can be a powerful motivator.

Maslow (33) is of some help in his description of the hierarchy of needs. In the modern western industrial environment the physiological and safety needs are largely fulfilled and the employee is, if Maslow's theory holds good, expected to strive for the higher needs, in hierarchical order, of,

belongingness and love need

esteem needs

self-actualisation needs

These "higher" needs roughly correspond to Herzberg's motivators, but the belonging need, stressed in the theory of primary psychological groups and demonstrated in G.T. environments, is fully considered.

Maslow's theory helps to explain the cause of industrial unrest prevalent in modern society, where people, having fulfilled their primary needs, are striving for need satisfaction in an environment which is intellectually and practically not yet prepared for this

changed level of need fulfilment. "As the standard of living in society improves, not only is the individual able to satisfy his physiological and safety (security) needs but the society is better able to take care of the poor, the sick, the unemployed and so on. In an affluent society, therefore, the higher needs of esteem, socialisation and self-actualisation will be the more important influences on behaviour". (67)

It must also be remembered that apparent motives promoting a certain course of action are not necessarily the real ones. The militant shop steward may be lacking in increased group belongingness and heightened self esteem. The call for higher wages may be the expression of employees' needs for self esteem and higher respect. Hence the considerable preoccupation of working groups with pay differentials rather than real levels of income.

It is interesting to relate the previous discussion to the results of a recent survey on "happiness" (68). Table IV shows the rating of specific "happiness factors" (1 = highest) which grades such aspects as

- friends and social life
- job or primary activity
- recognition, success
- personal growth

particularly high, all of which rate significantly higher than financial aspects.

The argument is further supported by the interesting phenomenon that people will often continue to work, even if there is no financial reason. The need of work for psychological health is stressed by researchers (66).

The concept of a "happy" work-force is, however, regarded as simplistic. Argyris shows from a literature survey that man's aim is not simple "happiness" but rather fulfilment of his latent talents. He claims that some degree of tension is required to spur people onto greater challenges and offer satisfaction upon their attainment, i.e. "individuals look for responsibility, develop commitments, and establish challenge ... What man actually needs is not a tensionless state but rather the striving and struggling for some goal worthy of him" (69).

Herzberg (70) lists the major "ingredients" for job enrichment, which must be considered in manufacturing systems design as

- direct feedback of results, preferably not through the supervisor or performance review
- a "client" relationship to another function, which is supplied
- the opportunity to learn
- the opportunity to develop unique experience
- the scheduling of his own work by an employee
- control over resources
- direct communications authority
- personal accountability

Similar factors are quoted by Argyris (69) and Rice (56).

One may reflect on the evidence in the literature (69), that firstly these factors are generally less satisfied as one goes down the hierarchical organisation scale, and secondly, that mental health tends to deteriorate at lower levels.

There have been reservations from trade union sources (71) pointing out quite rightly, that schemes to improve motivation have

generally been introduced to overcome specific management problems, rather than as a result of higher motives. Whilst such a realisation may cause some degree of cynicism, it is only by external pressure on established values that change will be introduced. To expect attitude change without external pressure would be naive, and no doubt, changes such as outlined previously will for some time yet be motivated by external pressure on existing standards.

The literature does indicate, however, that startling benefits can result from group working and increased participation, and that employees may even change long established attitudes towards unions, accepted practices and fears of exploitation. Increased output, improved quality, better morale and lower labour turnover have been quoted for practical examples in industry (72, 73, 74, 75, 76). There is no doubt that a happy, well motivated work force can be a reality (Figure 34).

Most reports on human aspects of group working have been from flow-line assembly cases, which probably represent the worst cases of boredom, monotony and job specialisation, but it has been pointed out (77) that it is still necessary to investigate the extent to which batch production may benefit from similar schemes.

6.4.3 TASK IDENTIFICATION

The organisation structure must enable all members of the organisation to identify with the objectives of the business.

For an individual operator, clerk, supervisor, etc. in a functional organisation, the identification with the product is difficult, since each person only sees a narrow functional aspect of the total

manufacturing process. A grouping of employees around specific products can achieve this product identification. Thus, if a small group of employees can be made responsible for the total manufacture of a product, a maximum product identification can be achieved. Often the product complexity makes it impossible to form small enough groups for this purpose, but experience in G.T. in recent years seems to suggest that groups developed around component families, and working in close association with assembly groups, can achieve acceptable measures of task identification.

6.4.4 OBJECTIVE PERFORMANCE MEASUREMENT

The measurement of performance of employees requires the setting of objectives, and the measurement of the degree to which they were achieved. The functional organisation makes the setting and monitoring of objectives difficult. Objective performance must optimise overall systems performance, and thus requires that certain functional areas are sub-optimised to the benefit of other functional areas.

"A weakness is the difficulty of setting objectives in the functional pattern, and of measuring the results of functional worth, for the function as such is concerned with a part of the business, not with its whole. Its objectives will, therefore, tend to be set in terms of 'professional standards', rather than in terms of the success of the business. They will tend to direct the attention and effort of managers away from business success, rather than toward it, will tend too often to emphasize and to reward the wrong things. It is only by focusing individual behaviour on the accomplishment of overall goals that the organisation is able to accomplish its objectives" (6).

Fazakerley (78) stresses the three key variables of cellular manufacture as:-

- 1) Clarity of objectives
- 2) Delegation of responsibility
- 3) Relationships with management

The need for clear objectives and responsibility for their achievement must be built into the system, and this requires a change in attitudes amongst managers. It is no surprise that resistance to G.T. is often found amongst middle management (79). At the same time, the lead must come from management. Clearly there exists a potential for considerable conflict, and management education is essential.

6.4.5 PLANT AND EQUIPMENT

The plant and equipment need to be matched to the product range. Investigations in the past (80) have shown that the matching of parts to machine tools in functional machine shops has been less than successful, with the suggestion that small operational manufacturing groups, e.g. G.T. cells, are more capable in matching their machinery requirements to their specific needs.

Furthermore, a narrow range of tasks in a small operational unit makes it easy to analyse the technological requirements of the product range, and may lead to considerable improvements in technology and hence productivity.

As discussed previously, the ABC Company produce a range of products, which divides into "obvious" component families. Each family of parts has close geometrical and technological similarity

across its constituent component range. It was believed by the ABC Company that the optimum plant size is in the order of 250 to 300 direct employees. The limit was related to local labour availability, and recruiting campaigns in boom period have shown that higher labour levels cause a disproportionately higher level of turnover, and lower average skill availability. The labour market constraint has led to a strategy of producing critical parts "In-House", and sub-contracting all other items. This make-or-buy strategy has streamlined the "In-House" manufacturing pattern significantly, and a small number of closely knit component families utilise in the order of 80% of the machine shop. A number of machine tools are specifically engineered for their specific component family. The company has preferred to purchase general purpose machine tools with dedicated tooling to maintain flexibility.

Only those machines of high inflexibility, such as transfer lines were recognised as "dedicated" machine tools. The wide range of parts within any one family made such a concept generally unacceptable and the policy of using general purpose machines with dedicated tooling seemed a sound one. The tooling had as a rule been designed to suit specific parts, however, and special tooling was so expensive that some of the benefits were lost. Early G.T. work in Russia (82) has demonstrated that the high changeover costs associated with component dedicated tooling can often be reduced to negligible proportions by using family dedicated group tooling. There is general agreement these days that parts manufactured in families require parts-family-based processing, tooling and scheduling to minimise tooling, production engineering and changeover costs. (79).

There is considerable potential to improve the ABC Company's

manufacturing technology by effort in areas such as

- standardising methods, feeds, speeds and tooling, based on a thorough study of a parts family
- the reduction of component and component feature variety to reduce change-over and tooling cost, and to simplify the range of technological tasks.

Work in component classification and coding has demonstrated the advantages of reducing component variety, but it must be remembered that component feature variety is just as much of a problem. Common features such as hole size and depth, turned diameters, tolerances, threads, undercuts, casting allowances, etc. reduce tooling inventory significantly. Using technological sequencing, change-over effort between parts can be reduced to a minimum.

The use of industrial robots needs to be investigated. In a cellular environment, where machines are close together, producing parts in similar sequence, reprogrammable robots can reduce the manual chore of loading and unloading significantly (83).

Using robots or automatic load/unload and transfer equipment, is of course conducive to increase job enrichment, by reducing the routine movements of the work to a minimum. Manufacturing systems design must utilise such automation to a maximum extent within constraints of flexibility and short batch change-over times.

It can be observed in engineering workshops that setter/operators for fully automatic machines such as cam automatics and gear cutting equipment tend to have high status and seem to have a greater degree of job satisfaction. Increased automation to reduce work monotony can lead to a change from machine-tied operator to process-orientated

controller, with broader output-based objectives of establishing and maintaining a technological process of significant complexity.

6.4.6 FIXED ASSET UTILISATION

Plant utilisation is predominantly a function of flexibility of application, size of plant and scheduling efficiency. Flexibility relates to the ability to use machinery for a wide range of tasks. A capstan lathe, say, can be used for a wide range of applications, and utilisation is less dependent on product type than, for example, a transfer line dedicated to a single product type where utilisation is largely a function of product demand. Where a plant is generally product related (i.e. special purpose), utilisation will tend to be lower. Size of plant can influence utilisation in conjunction with plant flexibility. Where a machine tool is added to a functional plant for capacity reasons, it is generally found that the additional machine is only partially utilised until sufficient business volume is accumulated to fill its capacity. In other words, machine capacity addition is a step function, as distinct from business volume, which is a continuous variable. Capacity can, therefore, not be perfectly matched to business volume. Where a number of identical machines are available, it is likely that prior to the purchase of the last machine, all existing ones were fully utilised (subject to scheduling efficiency) and with the addition of the new machine only this latter one is partially utilised. Thus, as a generalisation; it may be argued that, for any one machine TYPE in a plant, one machine is partially and all others fully utilised.

Assuming the average utilisation of all "last" machines to be 'A' in a plant with 'N' machine tools of 'M' machine types, average

overall plant utilisation could for ideal conditions be calculated as:-

'M' machines at 'A' % utilisation

('N' - 'M') machines at 100% utilisation

$$\text{Average utilisation} = \frac{M \times A + (N - M) \times 100}{N} \quad \%$$

$$= 100 - \frac{M (100 - A)}{N} \quad \%$$

Thus machine utilisation will tend to increase with an increase in the total number of machines, and a decrease in the total number of types of machines.

The analysis would suggest the need for large machine shops without segregation for optimum utilisation, and, indeed, a popular criticism against G.T. is a claimed tendency to reduce machine utilisation. The argument does, however, ignore the aspect of scheduling efficiency which is generally improved in small manufacturing modules. G.T. applications in general have benefited from reduced set-up time, and productivity, reducing the need for capacity (79). Indeed, the average utilisation in functional machine shops tends to be exceedingly low, both in terms of capacity utilisation (80), and time utilisation, with the latter typically below 50% (37) for cutting time. The discrepancy is due to a variety of losses such as:

Idle, operator absent.

Setting and Handling

Waiting Inspection

Waiting Tooling

Waiting Material

suggesting that the under-utilisation due to small size in a small

operational module is less significant than commonly assumed, and that scheduling/management/technological efficiency has a significantly greater impact on utilisation. This argument appears to be supported by a marked lack of published evidence that G.T. increases the requirement for machine tools.

Asset utilisation is not only concerned with plant utilisation, however, and to consider this aspect in isolation is too narrow a view. Assets generally include:-

Fixed Assets (Plant, Machinery, Buildings, etc.)

Inventory

Payables

Receivables

The manufacturing function has little control over the latter two, but fixed assets and inventory are significantly affected by manufacturing strategy.

A high machine utilisation requires that work is available for each machine when capacity becomes available, and high work-in-progress is generally maintained where high machine utilisation is a prime objective. High work-in-progress is also a characteristic of the large functional machine shop. The experience of G.T. users seems to indicate that work-in-progress is a function of work-flow complexity, operational unit size and organisational efficiency.

Simulation work has been undertaken by Rathmill and Leonard (84) to compare the cost effectiveness of a functional lay-out relative to a G.T. layout, measuring

- work in progress (WIP) cost, and
- machine waiting cost (MWC)

The analysis shows, naturally, that theoretical scheduling efficiency (in terms of minimising WIP plus MWC) improves with functional lay-out size and that for an uncontrolled environment, the scheduling efficiency of the functional shop is superior to the G.T. shop.

Figure 35 (a) shows Rathmill & Leonard's hypothesis for the functional layout, where WIP as well as MWC reduce with shop size. Figure 35 (b) shows the combined costs for the two different conditions, where

- i) there is a high machine variety so that there is limited machine interchangeability, and in
- ii) there is a high machine interchangeability, providing high scheduling flexibility and thus short waiting times.

In the case of the ABC Company, case (i) applies, such that the slope of the cost curve is likely to be shallow and limited advantage will result from the shop size.

There would in any case appear to be a contradiction of Rathmill and Leonard's work in so far as large shops tend to have poorer scheduling effectiveness and certainly high WIP, but often also high MWC, apparently resulting in a cost curve like Figure 35 (c).

No research has been conducted in this area, but one may suggest that the true curve of cost to size is probably as per Figure 35 (d), where costs reduce with size increase, but at the same time increase as manageability reduces. The theory would suggest an optimum shop or G.T. centre size such that manageability cost plus WIP plus MWC is a minimum.

An interesting consideration at this point is the fallacy of

regarding machine tool cost as an unrecoverable expenditure, but stocks as a fully recoverable investment. Both types of asset may have a similar cost of capital, and where plant and machinery have a depreciation cost, stocks have a holding, wastage and handling cost.

Typically, the total inventory cost, including capital cost can be estimated as 30%, as against a plant cost of 20% capital cost plus 10% depreciation cost.

As a first approximation, one can therefore, assume inventory cost to be equal to plant cost, so that any organisation which minimises combined fixed asset and inventory cost will approximately optimise asset performance. Thus additional plant and equipment investment could be justified if such investment would result in an inventory reduction of at least equal magnitude.

A typical asset value distribution would be

Fixed Assets	30%
Productive Inventory	50%
Others	20%

Inventory reductions can be significant in a G.T. type system and overall reductions of up to 50% when changing from a functional manufacturing system have been claimed by users.

For the example above a reduction in inventory of only 10% could, therefore, justify a fixed asset increase of 17%.

6.4.7 LABOUR UTILISATION

Labour utilisation is equal to machine utilisation where operators are linked to specific machines without flexibility. Such a policy is wasteful, and in recent years the work in G.T., which more clearly

recognises the need for plant under-utilisation, has led towards the concept of "floating labour" (79), where operators are moved from machine to machine, depending on work load. By using operators on different machines, operator utilisation can be minimised irrespective of machine utilisation.

Where the operating unit is small, informal movement patterns can be arranged within the group depending on work requirements (79). The principles of primary group formation discussed earlier, makes it undesirable, however, to move labour across group boundaries into different operating units.

6.4.8 WORK MEASUREMENT AND PRODUCTIVITY

The question of labour utilisation affects the traditional direct and indirect labour split. A typical ratio of direct to indirect manufacturing employees (the latter including salaried staff) of approximately 1.0 can be expected for the overall manufacturing function in an engineering plant.

Within the total labour force, the direct operators are carefully monitored on an hour-by-hour basis, with rigid control of all time not booked onto direct work (i.e. labour utilisation control), and productive time exceeding pre-determined standard time (labour efficiency control). The tight control traditionally causes resentment and fear, and operators are striving to maximise standard times. Once they have achieved high standards, they will be reluctant to improve on them. Even where incentive payment schemes are not used this phenomenon can be found, and it is prevalent in the Company here discussed.

If one considers that direct labour cost may only be around 10% of sales revenue, the excessive effort to control and reduce this one cost item must be questioned.

It is appreciated that standards are necessary for planning and overall plant monitoring, but it is likely, in the author's opinion, that close hour-by-hour control of operators to standard will inhibit productivity.

Furthermore, the bureaucratic functional organisation is likely to lead to poor indirect and staff performance caused by:-

- (a) considerable communication cost
- (b) poor commitment to task, low motivation and hence low (and uncontrolled) productivity.
- (c) Poor objective identification leading to wasted effort

Indeed, it has been mentioned (49) that many companies lose 25% or more of their effectiveness in the co-ordination of internal activities.

It is suggested, therefore, that a more effective arrangement is to incorporate the maximum number of indirect and staff tasks within each working group, and minimise external functional services. There is no practical reason why operators should not deal with certain indirect tasks. Overall performance measurement is, in fact, enhanced by measuring for each manufacturing centre the output against total labour input, including indirects. Such a system is simple in technique and has the added advantage of providing a true cost allocation, thus avoiding the more or less arbitrary allocation of functional services in blanket overhead rates.

7. THE PRODUCTION MODE

7.1 INTRODUCTION

The production mode was earlier defined as the "blue print" for the overall manufacturing system, providing in broad outline the systems elements and their interfaces.

Below is a description of a production mode specification for the ABC Company's plant, based on the preceding analysis, and dealing in overall terms with aspects of

- structure of the material flow system
- the worker assignment and organisation frame-work
- the work flow
- the technological system.

7.2 THE STRUCTURE OF THE MATERIAL FLOW SYSTEM

The traditional functional organisation has failed to provide a modus operandi, acceptable in the modern industrial environment. The modern trend leads us towards self-contained working groups which require homogenous work tasks, largely independent of other work groups, responsible for a clearly defined task completion.

The need to broaden the work tasks requires that personnel become more flexible, and it will thus call for the blurring of the traditional blue and white collar segregation. Rigid bureaucratic organisations built up on "classic" theories of job simplification, and specialisation are increasingly socially unacceptable. In order to maintain manageability, without rigid bureaucratism it is necessary to keep group tasks and inter-group connectives simple to enable each group to oversee its range of tasks effectively.

It is thus suggested that for the ABC Company, the manufacturing function should be organised through a pyramid of federal decentralisation, i.e. the total activity should be split into a number of significantly self-contained divisions, and in turn each division should be split into a number of largely self-contained groups, each one supporting its division, but each one with its own clearly defined range of accountable and measurable tasks

The process of federal division should be continued until operational units reach primary psychological group size, or, as summarized by Malik, Connolly and Sabberwal (28), one should strive for:-

- i) "The reduction of the work input (i.e. supply) to each production section to a minimum, ideally one supplier."
- ii) "The splitting of production into product groups (assembly industry)."
- iii) "The creation of as much product group autonomy as possible - in the reporting structure, span of control, and physical layout consideration."

The ABC Company's product range allows the formulation of product groups based on specific families of products. An analysis shows the following grouping potential:-

PRODUCT GROUP

Vane Units

COMPONENT FAMILY

Rotors

Rings

Wear and Pressure Plates

Vanes

Bodies and Covers

Shafts

Mobile Valve	Spools
	Bodies
Miniature Valve	Spools
	Bodies
	Modules and Sub-Plates
Directional Valve	Bodies - large
	Bodies - small
	Spools

A flow pattern as per Figure 36 thus emerged.

In practice, some compromises were required:

- i) Directional valve spools and vane unit shafts need to be produced in one service cell to avoid excessive machine duplication.
- ii) A miscellaneous parts cell must be established for various items which do not fit into the general flow pattern.

7.3 WORKER ASSIGNMENT

As discussed in the literature, each operational unit at each level should have clearly identified tasks relating to business objectives in terms of:-

- cost
- quality
- delivery performance

The manufacturing programming activity must, therefore, be arranged in such a manner that each centre can clearly recognise its

contribution to output.

This is easiest achieved using MRP (41) techniques, where the overall production programme is split firstly into five separate programmes for the five product groups respectively, and then exploded into part requirements, grouped together for each centre. Each centre can thus clearly identify with the plant output programme, and readily note the effect of poor performance on the plant performance as a whole.

To fully appreciate the effect of programme shortfall, the product centre needs full responsibility for progress, quantity performance and stock control for the items produced in the centre, and such a policy re-affirms the need for decentralisation.

To ensure commitment to group objectives, each operating module will have a fixed staff. Within each module flexibility of labour is essential, but movement of labour into other modules must be minimised.

There may be a formalised system, by which operators are "loaned" to other work centres at times to cover load imbalance. All operators should, however, maintain their home base, and such "loans" should only be for short periods. Permanent or long period transfer should be by mutual consent only, and it may be useful to pay a nominal "disruption allowance" to operators transferred for longer periods, say, longer than two days.

Machine tool and equipment under-utilisation may be necessary to achieve the organisational system proposed, but material flow control procedures must ensure that total asset levels are minimised.

The changed emphasis from machine tool utilisation to overall asset minimisation is a crucial aspect of the production mode suggested

here. Again, only decentralisation makes this possible, but it calls for accounting procedures which produce rudimentary profit and loss accounts for individual work centres.

If the concept of machine under-utilisation is accepted, the concept of labour mobility must be introduced at the same time. This popular pre-requisite of G.T. (79) demanding that operators are able to use more than one machine, and move from machine to machine in relation to the work load, is already practiced in the ABC Company. Thus a typical cell is expected to have more machine tools than operators, and at any one time some machines will be idle.

The previously identified requirements for job identification, job enlargement, and group involvement, call for the design of administrative procedures, such that operators become responsible for peripheral, clerical and service activities, and the differentials between staff, indirect and direct labour, are largely removed.

The worker assignment should thus be a relatively informal one of "group member", with responsibilities to operate certain machines within his range of training, as well as the ancillary tasks of monitoring progress, quantity performance, tool maintenance requirements, etc.

Following are some activities which are usefully incorporated within cells as decentralised functions.

Quantity Control

The ABC Company spent considerable time and effort controlling manufacturing quantities to ensure that firstly, accurate inventory and stock records were maintained, and secondly, that any pending shortages were signalled as early as possible for action. If a cell loading system is used, which clearly ident-

ifies the manufacturing cell load with the assembly programme, the cell personnel can identify pending shortages, and signal the need for action only, if unplanned action is essential. The existing "diversion control" system could be reduced dramatically to act as a stores input/output control only.

Delivery Control

Where batches are totally under the control of one supervisor in a small self-contained cell, progress can be covered by the cell personnel. In G.T. type cells, internal cell progressing is normal (8), and throughput times are invariably sufficiently short and predictable to eliminate the need for an independent progress system and its attendant computer programmes.

Material Handling

The cell personnel would normally handle their own material movement. Ideally no specific material movement personnel would be used, but any temporarily unemployed cell employees would be employed. Such a system also leads to the useful utilisation of unavoidable operator waiting times.

A formal trucking system for inter-cell material transfer should be used as a centralised "posting" service. Each cell should have a transfer point, from where labelled material is removed and incoming material delivered.

Quality Control

G.T. work as Herbert (86) and Ferranti (87) has shown that inspection can, to a major degree, be an operator activity, and the delegation of the inspection function to the cell has been used by Ferodo (22). Such a procedure can beneficially affect

quality levels as well as job interest. There is, of course, a need for an independent quality control function to set standards and procedures, and assist in scrap and reject analysis.

Tool Control

Specific cell tooling can be held in a cell, and the cell personnel be given the responsibility to monitor maintenance requirements. It is anticipated that the cell delegates the checking of tools to a central service, and returns tools for checking and re-sharpening. It is suggested that general consumable tools are held in a central store to avoid stock duplication.

There will be a need for central services, however; a modern business requires the skill and know-how of trained specialists to ensure the use of the most up-to-date technology and systems available. These services should be limited to those areas where it is unreasonable, and uneconomic to use decentralisation, or where central co-ordination is required. The type and extent of these central services will vary from company to company, and the following functions refer to the ABC Company only. Similar principles apply in other firms.

Industrial Engineering

Industrial Engineering may be regarded as a central service to the product centres, responsible for methods, tooling, machine tool selection, new product cost estimating, etc. To enable each cell to determine its own requirements it is essential that cell members (as a group, not individually, and normally through their supervisor) retain the right to approve all industrial

engineering work prior to implementation. There is no reason, of course, why industrial engineering cannot be split over the two main areas of vane unit and valve manufacture respectively.

Purchasing

It is normally inefficient to decentralise purchasing, but it may be feasible (as in industrial engineering for that matter) to make buyers responsible for specific product centres. To ensure co-ordinated supplier contact, some degree of purchasing specialisation will invariably be required. The question of purchasing decentralisation may well be related to product centre use in any case.

Data Processing, O & M

Computer services are centralised activities at today's state of technology. For administrative and clerical systems, including documentation, a central service is required in order to obtain smooth interfacing between all plant activities and their external environment, and to ensure minimal systems development, utilising up-to-date technology.

Manufacturing Programming

A centralised function to act as the central manufacturing programme co-ordinator is required in the Company as discussed earlier. The same function deals with all aspects of long term resource planning and closely works with industrial engineering and the product centres.

Following is a list of manufacturing and associated service activities in the ABC Company's plant. These are marked respectively:-

- C - Cell based
- P - Product centre based
- F - Factory based
- C/P - Largely cell based with some product based
- F/P - Factory based, but split by product centre
- C/F - Cell based, but some factory based

The designation defines the anticipated degree of decentralisation of each activity, and is based on judgement only.

Purchasing	F
Personnel	F
Data Processing	F
O & M	F
Machine Shop Loading & Scheduling	P
Manufacturing Programming	F
Sales Order Entry	P
Assembly Scheduling	P
Material planning - raw material	P
Material planning - machined parts	P
Material planning - purchased parts	P
Progress - machined parts	C
Progress - purchasing	P
Finance	F
Industrial Engineering	F
Phase-in, phase-out co-ordination	F
Goods Receiving	F
Finished parts store	P/F
Raw material store	F

Materials handling	F
Maintenance - machine tools	P
Maintenance - plant & buildings	F
Quality Control	F
Inspection	C
Salvage & rework	C
Tool Room	F
Tool Control	C/F
Tool Store	F
Machining	C
Assembly	C
Test	C
Packing	F
Shipping	F
Security	F

Grouping related activities, the following listing is obtained:-

'F' - Personnel

Data Processing, O & M

Manufacturing Programming

Finance

Phase-in, Phase-out

Goods Receiving

Building Maintenance

Quality Control

Tool Room

Packing

Shipping

Security

Purchasing

Materials handling

Industrial Engineering

Finished part store - general items

Raw material store

Tool store

'F/C' - Tool Control

'P' - Machine Shop Loading & Scheduling

Assembly Scheduling

Material Planning - new material

Material Planning - machined parts

Material Planning - purchased parts

Finished Part Store - product related items

Sales Order Entry

Maintenance - machine tools

'C' - Inspection

Salvage & rework

Machining

Assembly

Test

Progress

A rationalisation into activity areas suggests itself which forms the basis of an organisation structure.

FACTORY SERVICES

- Personnel

Information Systems

Finance, Security

PRODUCTION PROGRAMMING	-	Manufacturing programming
		Finished part stores - general items
		Raw material stores
		Product Phase-in, Phase-out
INDUSTRIAL ENGINEERING	-	Building maintenance
		Tool Room
		Manufacturing Engineering
		Tool Control
		Tool Store
		Maintenance co-ordination
DISTRIBUTION SERVICES	-	Goods Receiving
		Packing
		Shipping
		Materials handling
PURCHASING		
QUALITY CONTROL		
PRODUCTION PLANNING	-	Sales Order Entry
		Machine Shop Planning
		Assembly Planning
		Purchased Parts Planning
		Inventory Control - Stock Control
		- Performance
		monitoring
		- Materials handling
MACHINE TOOL MAINTENANCE		
CENTRE ACTIVITIES	-	Production - Machining

	-	Assembly
		Test
		Materials Handling
Control	-	Quantity Control
		Delivery Time Control
		Tool Control
		Clerical (performance monitoring)
		Inspection, salvage & rework

The proposed structure is most easily appreciated using Alcalay and Buffa's (88) concept of regarding manufacturing per se as the sub-system responsible for "creating the goods", and regarding other support activities as service and control sub-systems.

Thus the previous breakdown can be further split into

Manufacturing	-	Production Planning
		Machining
		Assembly and Test
		Machine Tool Maintenance
Technical Services	-	Industrial Engineering
		Quality Control
Factory Services	-	Personnel
		Finance
		Information System
Logistics	-	Production Programming
		Distribution Services
		Purchasing
		Centralised Stores

The concept of "Logistics" (89) covers the overall production planning activity of the plant and the supply of purchased materials, to ensure that programmes can be met.

Figure 37 shows a proposed organisation chart to support the above discussion.

Bowey & Connolly's (50) concept of the orbital management structure can be usefully applied and a typical group organisation structure for a valve product centre is shown in Figure 38. The structure shown is conceptually "imperfect", in as far as it admits a product centre manager in line control and does not totally delegate the operating control to the facilitator group.

As such the proposal should be regarded as an interim one, with the product centre manager gradually reducing his role to that of a two-way communicator. In the long term, the product manager should become redundant, replaced by an elected representative to the co-ordinating group.

7.4 WORK FLOW AND PLANT LAYOUT

The flow structure and worker assignment specification suggest a hierarchical plant layout structure.

It is required that the plant is split into a number of geographically compact, single area product centres to ensure easy manageability and good visual product centre identification. Figure 39 shows an outline block diagram for the Plant, whereby such a product split is achieved.

Common plant services such as heat treatment are minimised, and, where unavoidable, are centralised as service functions to the plant,

controlled by the technical services department.

Within each product centre, machining and assembly cells are to be clearly defined in distinguishable separate areas. Finished plant storage is maintained in the product centre.

The work flow should be controlled by roller conveyors. The use of conveyors in work flow has been discussed in detail elsewhere (9), but the key benefits may be regarded as:-

- i) controlled flow patterns
- ii) cheap and easy material movement
- iii) limited work-in-progress storage area promoting rapid throughput time
- iv) clear visual indication of production bottlenecks, allowing direct operators to respond informally to level fluctuations

The latter item is particularly important where operators are expected to "float" between work-stations in response to work load changes. The conveyor acts as a physical model of the work-flow pattern, and allows operators to take decisions to change to other work-stations without complex progress monitoring and consequent directives from progress clerks or supervisors.

The use of conveyors for work-flow disciplining, in conjunction with floating labour, allows the use of low transfer quantities between operations. The literature (9, 79) discusses the use of small containers sequenced in a pre-determined manner, such that batches can be broken down into a number of separate quantities. Work is transferred in containers between operations, allowing significant operation overlap, and hence short batch throughput time. Since line balancing in a multi-product machining line is a complex dynamic

problem, which can practically only be solved for simple cases, floating labour and less than optimum machine utilisation to balance load fluctuations must be used in such a situation.

7.5 THE TECHNOLOGICAL SYSTEM

As discussed previously, the ABC Company already used a number of machine tools dedicated to specific component families.

Bearing in mind the earlier consideration of group working, long product life, clearly identified component families, the need for reduced set-up times, and the likelihood of less than optimum machine utilisation, the following systems design parameters could be specified:-

- use of special purpose machines to suit the specific task required
- such special purpose machines to be fully adjustable to allow the machining of a wide range of similar parts and output volumes
- machine tools may be adaptations of standard machines with certain features added (perhaps within the tooling and fixtures) and certain standard features left off to achieve a price reduction
- modular design machine tools and flexible transfer lines should be used to balance flexibility with low cost
- in those areas where a balanced flow line can be used (e.g. mobile valve bodies), the use of automatic work transfer, loading and unloading equipment, perhaps using industrial robots for work handling, should be investigated
- all tooling should be designed on the group tooling principle

to minimise change-over times, and to allow maximum tool pre-setting away from the machine to, firstly, minimise batch change-over times, and, secondly, reduce machine occupation during set-up

It should be noted that pre-set tooling does not reduce set-up time to that used on the machine itself. To assess economic batching, the pre-setting cost must also be considered. Pre-setting is, therefore, less effective than quick-change adjustable group tooling, such as described in the literature (79, 82). The production mode which aims for small batch production must, therefore, rely heavily on this type of tooling and fixturing.

There is a considerable cost attached to a change-over from conventional to group tooling and further study would be necessary to review the economic benefits of replacement.

It would normally be expected that a change to group tooling would be largely confined to new product introduction.

Methods and tooling can be designed such that change-over times are minimised between two or more specific components. By loading parts in a specific sequence it may be possible to minimise change-over times between any two parts. Such a condition is reached where parts are sequenced in such a manner that the change in machine set-up features is a minimum between any two parts loaded in sequence. The concept can become complex for parts requiring a number of different processes, and priority rules may need to be defined (9).

8. THE ADMINISTRATIVE PROCEDURES OF THE MATERIAL FLOW SYSTEM

8.1 INTRODUCTION

To deal with the problems of lack of forward visibility within a fluctuating market demand pattern, a short lead time for product manufacture must be achieved, using

- a) short machine shop throughput time by means of a cellular shop layout, utilising
 - i) maximum operation overlap
 - ii) simple material flow patterns
 - iii) close control to minimise the need of work-in-progress buffers
- b) low batch quantities, and hence short loading cycles requiring short set-up times
- c) machining and assembly co-ordination to minimise finished part buffers
- d) reduction of the "administrative chain" in planning and control.

A short throughput time implies low work-in-progress, and hence low scheduling flexibility, and systems effort must be directed towards minimising the risk of such a strategy. It is, therefore, necessary to design control systems which:-

- i) balance manufacturing load fluctuation
- ii) ensure predictable batch completion dates
- iii) provide adequate material supply at the correct time
- iv) ensure a reliable delivery of sub-contract and purchased parts

In particular it is necessary to ensure good vendor performance,

and for raw materials, high buffer stocks may be advisable, though probably not in excess of the three months usage safety stock held by the ABC Company.

Careful capacity balancing is essential on a period-by-period basis, since work-in-progress buffers are no longer provided to offer flexibility, and variations of cycle length interfere with part output programmes.

The close linking of a number of manufacturing centres makes it essential that controlled throughput times are achieved across the whole product group. The problem emphasises the need to concentrate quantity and delivery control within each cell to ensure rapid response, whilst at the same time using a management group to co-ordinate the overall product group effort.

The key to any material control system is the matching of two elements,

- i) the allocation of customer orders to projected future material availability, and
- ii) the control of material flow to ensure future material availability to plan

In whatever form the manufacturing system is developed, the primary objectives of the material control systems design must be the best possible method of achieving these objectives within monetary and technological constraints.

8.2 MASTER SCHEDULING

Whilst in the past statistical ordering systems were used by Industry, based on economic batch quantities and re-order points,

their weaknesses (90) and the increased use of computers in production planning and control led to material requirements planning (M.R.P.) (90) as a standard technique. The M.R.P. concept explodes a production programme, based on a forecast or order book, into parts and, allowing for necessary assembly phasing, lists against each future time period the true requirements for parts; sub-assemblies and units to meet the production programme. The concept ensures that requirements are directly related to planned shipments. It also overcomes to a great extent the problem of statistical ordering, which accepts specific degrees of stock-out for each part, which cumulatively leads to either high safety stocks or high assembly shortage levels.

New (91) discusses the use of M.R.P. in conjunction with G.T. and shows that the two concepts are particularly compatible. Since the manufacturing system discussed in this thesis largely utilises G.T. concepts, the same close relationship between M.R.P. and the proposed manufacturing system exists.

The M.R.P. concept has been slightly extended by users to utilise the concept of a "Master Schedule" (92) which is effectively a production programme, matching the forecast or order book against available capacity, and allocating customer orders against it.

8.3 MANUFACTURING CYCLE DEFINITION

The problem of cycling is basically one of balancing the requirements for

- short lead times to minimise stocks to cover forecast errors,
- and

- low cost by running economic lot sizes, leading to longer lead times

Monthly cycles are currently used by the ABC Company for forecasting, order acceptance and machining, and assembly is arranged in weekly cycles.

Recent studies in the ABC Company have shown that order costs for assembly orders are extremely low and small batch assembly to short fixed cycles is acceptable.

The question of cycling is closely connected with machining-assembly linking, and, in turn, with marketing constraints. Taking the simplest case of making to order within adequate lead times, the low cost/low stock solution would be:-

- i) use a single-phase, single-cycle system (93)
- ii) machine all parts in the common assembly sequence
- iii) assemble as soon as machining is complete and ship to the customer

A simplified example is given to illustrate the concept:-

Assume that three assembly models, (A,B,C) are produced and each one has two piece parts (I & II) making six piece parts in total (A1, B1, C1, AII, BII, CII) with cost attached of

$$\begin{array}{l} A1 = B1 = C1 = 1 \text{ unit} \\ A11 = B11 = C11 = \frac{1}{2} \text{ unit} \end{array} \quad \left. \begin{array}{l}) \\) \end{array} \right\} \text{one part per assembly only}$$

Figure 40 (a) shows the linked concept: parts are machined, assuming $1/3$ period machining time and $1/3$ period buffer stock between machining and assembly. The stock curves are shown, with growth, as parts are progressively produced, held for $1/3$ period at full value, and decaying

as they are assembled. The graphs assume material cost to be negligible to simplify the illustration.

Assuming one part 1 and 11 per assembly and 10 assemblies each per period of A, B and C respectively, average stock levels can be extracted from the stock graphs:-

- A1: Stock is held for one period to support one period's assembly, i.e.
- $1/3$ period to build up manufactured parts (average level 5 parts)
 - $1/3$ period safety buffer (average level 10 parts)
 - $1/3$ period usage (average level 5 parts)

The stock curves can be added to give total mean stock levels:

$$A1: \text{ mean stock} = 1/3 \left(\frac{10}{2} + 10 + \frac{10}{2} \right) = \frac{20}{3}$$

B1: ditto

C1: ditto

$$All: \text{ mean stock} = 1/3 \left(\frac{5}{2} + 5 + \frac{5}{2} \right) = \frac{10}{3}$$

B11: ditto

B11: ditto

$$\text{Total} = 3 \times \left(\frac{20}{3} + \frac{10}{3} \right) = 30 \text{ units}$$

Figure 40 (b) contrasts the above calculation with a simplified version of the current situation in the Company, where all parts are produced for the total assembly month and then assembled progressively (i.e. in four sub-cycles, approximated here for simplicity as constant usage rate).

Mean stock are calculated as

$$A1: \quad \text{mean stock} = 1/3 \left(\frac{10}{2} + 10 + \frac{10}{2} \right) = \frac{20}{3}$$

$$B1: \quad \text{mean stock} = 1/3 \left(\frac{10}{2} + \frac{5}{2} + \frac{5}{2} + \frac{10}{2} \right) = \frac{30}{3}$$

$$C1: \quad \text{mean stock} = 1/3 \left(\left(10 + \frac{10}{2} \right) + \left(10 + \frac{10}{2} \right) + 10 \right) = \frac{40}{3}$$

$$A11: \quad \text{mean stock} = \frac{10}{3}$$

$$B11: \quad \text{mean stock} = \frac{15}{3}$$

$$C11: \quad \text{mean stock} = \frac{20}{3}$$

$$\text{Total} = 45 \text{ units}$$

Thus the stock cost penalty over the machining/assembly linked system is, in this case, 50% .

Figure 40 (b) also shows how the machine load fluctuations in the current system, resulting in increased batch throughput times and hence increased work-in-progress. The true stock penalty of the existing system could thus be higher than indicated by the above calculation.

Previous work (79) has confirmed that single-phase/single-cycle period batch control tends to increase finished part stock levels unless machining and assembly are linked. M.R.P. systems will thus provide a theoretically less than optimum solution, if all parts for a period's assembly programme are scheduled for one completion date across a limited output facility.

Efficient machining/assembly linking demands of course single-phase/single-cycle period batch control. Each manufacturing period is treated in isolation and only parts required for the period's assembly programme are produced in the sequence in which they are to

be assembled. Batch quantities are dictated by the cycle length, or conversely, the cycle length can be adjusted to the average economical batch useage period only. Such a policy conflicts with the economical batch quantity (EBQ) concept and would appear to generate higher than optimum costs. At the same time, the EBQ theory is grossly oversimplified (94) and as such should be treated with caution. Burbidge's (81) suggestion, that pre-planned batch sequencing in period batch control will reduce setting times sufficiently to invalidate the EBQ theory may be realistic in some cases, but where set-up times and machine depreciation costs are high, batch quantities tend to be cost sensitive (95).

If machining-assembly linking is used, all manufacturing cells in a product centre need to produce parts in the same, i.e. the assembly sequence. Where parts are closely product linked, no great difficulty should exist to achieve technological scheduling (79) for minimum change-over time in the same sequence in all manufacturing centres. More problematic is the paradox that machining-assembly linking, whilst reducing overall plant lead times, will increase mean response times to customer demand. Orders cannot be met until the unit affected is assembled in its pre-determined sequence. Thus, on average, the customer will need to wait half the cycle time plus machining, assembly and test time before his order can be met. Ideally, sales would collect all orders to make up one period's assembly programme in the period ahead and sort them for manufacture. Customer delivery times would typically be for, say, a 4-weekly cycle, as follows:

	<u>Maximum</u>	<u>Minimum</u>
Order collection	4 weeks	-
Machine-shop programming	1 week	1 week
Await machining start	4 weeks	-
Machining throughput time	3 weeks	3 weeks
Machining-Assembly buffer	1 week	1 week
Assembly-test throughput time	2 weeks	2 weeks
	<hr/>	
Total:	15 weeks	7 weeks
Mean	11 weeks	

The delivery pattern offered by the ABC Company to customers in the past shows that the majority of all orders were due within 8 weeks, making the linked machining-assembly system impractical for any but the shortest cycle lengths.

The wide variety and relatively high cost of modification of finished units, made it undesirable to make units to stock and a maximum proportion of the assembly programme had to be backed by firm customer orders. Furthermore, fixed order costs for assembly orders are negligible and thus a weekly assembly programme is technically quite acceptable.

If the assembly cycle is much smaller than the machining cycle, parts usage can be approximated by constant usage rate and the traditional statistical inventory control theory becomes valid as an optimum solution.

Figure 41 (a) demonstrates the single-phase/single-cycle system, where three parts are produced sequentially across the same facility and made ready for the start of their relevant assembly month.

Figure 41 (b) shows a concept of a "sequenced" re-order point

system, where stocks are replenished in perfect time sequence. Stock level are significantly reduced for Parts 1 and 11.

The above considerations suggest a concept of a usage replenishment cycle, where over each period all parts are reviewed in turn, and used quantities replenished, including both usage since last replenishment date and projected usage during the lead time.

The control of review dates causes practical problems, since the date shifts in time depending on individual parts' demand, but a good approximation of the above procedure can be obtained by:-

- i) splitting the production programme into short time period
(e.g. weekly periods)
- ii) using a regular ordering pattern, utilising an economic batch quantity theory related algorithm such as rota cycling (96).
- iii) ordering several period's requirements in each order, to suit
EBQ requirements

The procedure outlined is less efficient than machining/assembly linking, which is to be preferred, where machining and assembly cycles can be made common.

Where assembly cycles have to be significantly shorter than machining cycles, the procedure does offer a good economic alternative, which

- i) allows the use of economic batch quantity theory
- ii) minimises the delay between batch arrival into store and parts
usage
- iii) provides a close link between machining and assembly programmes,
where each component batch is produced to satisfy a specific
number of assembly periods

- iv) allows short reaction time to customer demand and thus maximises the percentage of assembly orders covered by customer orders.
- v) allows the use of technological batch sequencing for minimum change-over time if an ordered scheduling pattern is used.
- vi) offers the facility to programme specific known orders into particular periods, thus maximising machining-assembly linking where long delivery period orders are received.

The procedure approximately provides the "classic" saw-tooth shape of inventory levels.

In general one can identify the following acceptable alternative shop loading procedures

- i) common single cycle for machining and assembly, both based on firm customer orders
- ii) common single cycle for machining and assembly; machining to forecast and assembling to firm order, utilising safety stocks based on the mean absolute deviation (MAD) (97) between forecast and actual orders
- iii) different cycle lengths for machining and assembly:
 - a) single-cycle machining and single cycle assembly where the machining cycle is common to all parts and its length is an exact multiple of the time units length of the assembly cycle
 - b) multi-cycle machining and single cycle assembly linked by an ordered loading system such as rota-cycling

Alternative (i) is preferred for low stock cost and high manageability, but can only be applied if customer orders are firm for acceptable

time periods, or where unit demand can be sufficiently clearly defined to build up stocks.

Alternative (ii) is a useful method and provides good manageability. It is a realistic alternative to short machining cycles.

Alternative (iii) (a) is a compromise solution embodying the manageability of alternative (ii). It destroys some of the clear responsibility split between machining and assembly and reduces the job identification of machinists with product centre output. It is, however, required where customer delivery periods are shorter than can be reasonably accommodated by machining cycle lengths. For (iii) (a) it is necessary that economic usage periods for all parts in the product centre are similar within reasonable cost penalty limits.

Alternative (iii) (b) is the general solution where economic machining cycles are different for different parts and in the main longer than can be accepted by customers. An ordered system, based on single-cycle assembly loading and, for example, rota-cycle machine shop loading, provides many of the benefits of good manageability. The synchronisation of machining and assembly cycles allows a close linking of machining and assembly programmes, providing a reasonably simple order implosion capability and treatment of short notice demand charges.

The above alternatives offer a solution "hierarchy", starting from the most desirable down to the least desirable one. It is possible that different product centres within one plant call for different solutions. Federal decentralisation into product centres provides the opportunity to install the best solution for each product group. Systems must, however, be sufficiently adaptable to accept different rules for different product centres.

8.4 BATCH QUANTITY GENERATION

A considerable literature exists on the subject of economic batch quantity (EBQ) generation and many textbooks offer the formula below (98)

$$Q = \sqrt{\frac{2 A S}{I C}}$$

where Q = economic batch quantity

A = annual usage

S = variable setting cost

C = variable component cost

I = stock holding cost

A number of variations are possible to take account of other factors such as work-in-progress, quantity discount, opportunity cost, etc. Rathmill, Brunn and Leonard (95) provide a useful analysis of the EBQ factors and their effect on the batch quantity sensitivity.

With the increasing use of M.R.P. the theory is applied to calculate a specific number of order cycles for which the EBQ will satisfy anticipated demand. Popular methods are least unit cost (99) and least total cost (100). Complex procedures such as the Wagner-Whitin algorithm (101) have been recommended.

A method of calculating EBQ's for the co-ordinated supply of parts with one major and individual minor set-up costs has been proposed (102), which satisfies some of the requirements for batch size calculation within the concept of technological scheduling.

All of the above methods suffer from the problems of a "dis-ordered" manufacturing environment. The E.B.Q. theory ignores the interaction of different parts in the composite plant work flow. A plant, such as

the one here discussed, with a significant amount of dedicated machinery, demands an approximately constant production volume and mix, to ensure a reasonable degree of labour and machine utilisation. The random pattern of order release which is generated with E.B.Q.'s can result in significant fluctuations in short term machine loading. To absorb these fluctuations it is essential to have a high degree of work-in-progress, to cushion the impact of load fluctuations and level out machine loads. Thus, batch throughput times are high and delivery dates are unpredictable. Usually either a high occurrence of shortages must be accepted or else sophisticated computerised scheduling systems must be applied. Commonly the resulting work flow complexity coupled with the often slow response time of D.P. systems makes the use of the sophisticated scheduling system less than successful.

High set-up time machinery leads to high stock levels, and where high batch usage periods apply, the E.B.Q. concept requires a high degree of forward visibility. In practice forecasting becomes poorer as it moves further out in time, and the E.B.Q. concept with high usage periods leads to:

- a) high time constants in the production system and thus high amplification of fluctuations in demand pattern,
- b) high levels of stock-out for some parts and high levels of inventory for others as the gap between forecast and actual demand widens with time
- c) inability to react to demand changes in a reasonable time period.

It is unlikely that a reasonable E.B.Q. formula can be devised which includes the abstract concepts of manageability and job ident-

ification in an ordered machining/assembly linked system. It is considered within this thesis, that a simple ordering pattern is to be preferred, and whilst one may not always be able to subscribe to Burbidge's philosophy of single-phase, single-cycle period batch control (93), it should be attempted to simplify order cycling within reasonable cost penalty limits. Some arbitrary judgement is required, and the study in the appendix illustrates the thought process which can be applied.

Considering the current set-up cost for the ABC Company as a whole is only in the order of 1% of sales value, for average batch usage periods of two months, even a one month cycle period batch control system would not significantly affect overall cost.

It is likely that the savings in reduced inventory, better manageability, better customer service and reduced computer and production control effort would match the cost penalty.

Without some yardstick, however, the order quantity question cannot be solved, and the E.B.Q. formula provides such a yardstick. Sensitivity analysis (2) can be applied to the E.B.Q. concept to define maximum and minimum cycling frequency, within a pre-determined cost penalty (103) (Appendix I).

8.5 CAPACITY PLANNING

The factory capacity constraint is two-fold:

- i) the machinery capacity limiting the supply of specific products, and commonly referred to as the bottleneck machine or process. Where a significant number of machines or manufacturing centres are dedicated to specific component types, the plant output mix at maximum output is restricted and there will be a number of

capacity constraints, each one affecting a specific family group of units.

- ii) the labour capacity constraint, which is a total factory output constraint independent of mix, where labour is flexible.

The labour capacity constraint has in the short term and, to a lesser degree in the long term, upper and lower limits if labour under-utilisation is to be avoided. It is limited by the maximum and minimum hours normally worked and will generally only be flexible within the limits of overtime working if "hiring and firing" is to be avoided.

If either capacity constraint is reached, management must inject judgement to decide which units are to be built. The problem has of course a linear programming solution (104) but in practice the situation is complicated by the need to supply a balanced set of units. A shortfall of one model may affect the sales of others.

The machine capacity constraint can be covered by defining for each product class, the "pacer part" which has the lowest capacity limit. This part will control labour unit output, and the limitation is generally based on a "key machine", (or bank of identical key machines).

The total machine capacity limit for each product class is thus established by defining the key machine, its practical availability hours (i.e. net of holidays, planned losses and unplanned delay allowances) and, for each unit type, the labour hours per pacer part or parts.

Manufacturing programming thus consists largely of converting the forecast into a key machine load and, if the maximum load is

exceeded, reducing the programme to the capacity limit.

As capacity limits are reached, capacity is added and a new key machine may need to be determined.

In a cellular product-based environment, manufacturing cells are dedicated to specific product groups, and any machine overload immediately pinpoints the product group affected. It is thus desirable that, for simple manageable planning, those cells which supply more than one product group are provided with ample machine capacity.

The over-riding labour constraint is calculated by adding the sum total standard hours for all units and matching it to the total labour hours planned availability net of planned efficiency losses. As discussed earlier, for product identification, each product centre should be regarded as a separate plant in these calculations.

Having established a programme within the machine capability this programme is matched against planned labour availability and is adjusted to establish an acceptable overall programme.

It must be recognised that in a plant, using largely dedicated machinery, the product mix is significantly fixed if reasonable plant utilisation is to be achieved. The product range within each product class in the ABC Company appears to be fairly homogenous, so that mix changes within each class are unlikely to cause major problems, as long as the volume proportions of product classes to one another are in balance.

A number of capacity planning levels are feasible, such as

- i) finite loading of all work centres, with detailed overload analysis, by part number and product family

- ii) as (i) but using infinite loading
- iii) infinite loading of pre-determined bottleneck machines only, with detailed listing of load by part number and product family, using either a bottleneck machine for each manufacturing centre or one bottleneck machine for the total product centre
- iv) infinite loading of all work centres, providing percentage load levels only
- v) coarse loading of product centres to a pre-determined number of assemblies output only, probably weighting each assembly by its total work content.

Whilst (i) or even (ii) provide excellent data reports, the computing effort and data capture is considerable, and it is unlikely that such an effort can be justified in many instances. Alternative (iii) is useful, especially if supplemented by a load check from alternative (iv). Proposal (v) is only suitable as a variation of (iii), where total assembly output capacity is defined in terms of bottleneck machine capacity.

A procedure suggests itself as follows:-

- i) define the bottleneck machine for each product centre
- ii) run the forecast across the machine load programme and
 - (a) obtain percentage load levels for all work-centres
 - (b) obtain a listing by part number, associated product family and total load hours for the bottleneck machine of each product centre
 - (c) obtain a labour demand report, in terms of total number of direct operators required and available for each manufact-

uring centre.

The overload report allows management action to overcome the problem. The global percentage load check on all cell machines firstly provides useful data for long term facilities planning and, secondly, shows up instances where, due to abnormal conditions, the bottleneck machine has been wrongly indicated.

8.6 SUPPLY-DEMAND CO-ORDINATION

A separate analysis by the ABC Company staff has recommended a supply-demand interface structure with the following features:-

- i) A distribution centre (D.C.) acts as the supply-demand interface function
- ii) the D.C. issues a forecast in assembly numbers to manufacturing. The forecast is supplied on a rolling monthly basis, covering six months ahead.
- iii) Manufacturing will produce parts to forecast
- iv) the D.C. will issue firm orders in assembly numbers to manufacturing on a weekly basis, with four weeks delivery
- v) Manufacturing will explode the firm orders against planned availability, accept those orders which are covered by parts, and return orders with parts shortages to the E.D.C. for re-submission the following week.

These recommendations have lead to the following manufacturing control parameters:

- i) if total machining-assembly lead times of six weeks or less can be achieved, machining and assembly to firm D.C. order is

- feasible.
- ii) for longer lead times, machining to forecast and assembly to order is realistic
 - iii) if assembly number forecasts are used, the manufacturing system can be released from the burden of developing parts explosion routines to historical unit designation mix. Forecast entry is thus reduced to explosion and capacity analysis.
 - iv) with the use of the D.C. as a decoupling function, orders can be allocated to specific product groups, and the D.C. order entry and allocation functions can be combined with production planning, as a product centre activity.

8.7 MATERIAL CONTROL SYSTEMS OVERVIEW

The material control system has received particular attention in the production mode. As Serck Audco found from practical experience, " ... if materials are made available to the workshop in the correct quantities at the right time, and programmes once issued allowed to remain firm, they would, in most cases, be able to cope adequately". (47)

Such thinking was regarded as most important, and has been applied extensively in the proposed procedures.

The system recommended for the ABC Company plant is based on the management structure and worker assignment specified in the production mode, utilising the concepts of responsibility delegation to operating levels in a federal organisation. The administrative system utilises a hierarchical structure corresponding to the federal organisation

discussed above and as such, integrates fully with the laid down work flow and organisational principles.

Figure 42 shows the basic hierarchical structure, illustrating the decentralisation of the material control function into three levels, labelled for convenience as

- production programming: a plant-based co-ordinating function
- production planning: a product centre based material planning function
- ∴ production control: a work-centre based day-to-day plan execution function

Figure 43 shows the activities at each hierarchical level and the relationship of the separate activities to one another. The control systems hierarchy corresponds with the plant activity hierarchy developed previously to provide each operational level with its own control mechanism.

The key to the efficient control lies in the principle of controlled activity transfer.

At each level, the activities for the next lower level are matched to available resources, with time plans to suit the overall plant programme.

Thus at the programming level, the demand forecast is matched against planned resource availability for each product centre respectively. The production programme (master schedule) supplied to the product centre, is known to be achievable, and forms a valid execution plan, against which achievement can be measured with confidence.

At the planning level, work centre loads are similarly matched against available resources, to ensure that works-orders supplied to

work centres operating in parallel, to a common assembly programme, can meet their obligations.

Thus a co-ordinated supply structure is built up across the plant as a whole, demanding from each operating module a feasible performance.

Herzberg's customer-supplier concept (70) is usefully maintained,

- a) between production programming and the supply-demand group: production programming accepts customer orders and "ships" assembled units to the supply-demand group
- b) between production planning and production programming: production planning supplies assembled units to production programming relative to assembly schedules (i.e. orders), matched with the production programme.
- c) between work centres and production planning: machining cells "sell" parts to production planning to a firm programme (i.e. order) supplied by the former.

Assembly and test are logically treated similar to machining cells, i.e. as a "sub-contractor" to production planning, issued with material (i.e. parts) and orders (i.e. assembly schedules).

The administrative system is based on the concepts of

- simplicity - at times to the detriment of theoretical optimisation
- delegation of operational decision making to the hierarchical level most qualified to do so
- broadening of responsibilities of operators and junior management.

The proposals conflict with the concept of decoupling manufacturing and marketing by a planning function, and no separate planning function was planned within the Company's organisation.

The principle of matching supply (manufacturing resources) to demand cannot be ignored, however. The administrative system below is based on the concept of a plant-based production programming function as the supply-demand interface. Production Programming deals with the establishment of the production master schedule. In as far as the long-term planning aspects are not discussed in this thesis, the proposed structure does not significantly disagree with the earlier concepts of conflict resolution. It should be remembered, however, that in the organisation described, supply-demand co-ordination is a matter of negotiation, subject to the kind of political manouvering and the impact of executives' personalities which could be minimised in a conflict resolved structure with a clearly defined planning function.

Figure 44 shows the overall material control systems flow-chart. The key elements and files are shown, indicating how these individual elements, discussed below in detail, are linked together.

8.8 PRODUCTION PROGRAMMING

Production Programming is treated as a plant-wide service to the product centres, fulfilling the interface function between the supply-demand group and manufacturing.

The interface is usefully seen in two different contexts:

- i) short term matching of order intake to available capacity
- ii) long term planning of resource provisioning to meet projected future demand

This study deals mainly with the operational systems required to operate the company on a day-to-day basis and thus concerns

itself with short term aspects. Long term supply-demand matching is of course an integral part of business systems planning, but no analysis of this area has been provided in the following text.

The production programming function, dealt with in this chapter, concerns itself with

- forecast explosion
- capacity analysis
- preparation of a master schedule

Figure 45 shows a flow chart for the proposed forecast explosion and capacity analysis. A monthly forecast from the D.C. is read and a unit forecast file is created. Using a conventional infinite loading programme all machine tools are loaded. For the bottleneck machines a tabulation is printed, listing all operations planned as well as the operation hours and the machine practical plant capacity. Manual intervention is used to modify or decide on alternative action. Figure 46 and 47 illustrate the basic reporting formats required. After adjusting the forecast to avoid plant overloads, a modified unit forecast file can be created.

For those product centres demanding assembly to short delivery time, a weekly-based master schedule is required, as discussed earlier. Thus the four-weekly production programme needs to be split into four equal sized sub-programmes. In general the production programme should be split into four equal portions.

To override conditions exist:

- i) there needs to be a definition of economic assembly quantities for each unit type. If the four-weekly demand is less than four times the economic assembly quantity, the total four week

demand needs to be programmed as two or one order in the period.

- ii) with issue of forecast for the sixth month ahead (i.e. monthly forecast extension), firm customer order details for the sixth month with their promised delivery week can be supplied by the D.C.

The modified unit forecast is first netted by firm orders, which are allocated to their specific delivery week.

The remaining forecast is split in proportion to the remaining available time in each of the four weeks. Low quantity orders are placed into the first, or first and third week respectively until the full load for these weeks is achieved.

It is necessary to programme by total unit machining standard hours to get a good load balance.

Figure 48 shows a suitable flow chart to spread the unit forecast file accordingly. A Master Schedule File is established, listing for each week in each forecast period the unit requirements.

The master schedule and the medium range forecast are respectively exploded into their constituent parts, using the parts list file, and the requirements are entered onto the stock status file, which acts as the interface between production programming and production planning. The master schedule needs to overwrite the medium term forecast on the stock status file.

8.9 PRODUCTION PLANNING

8.9.1 THE STOCK STATUS FILE

Production planning is within the proposed system, the product

centre material flow co-ordination function.

The heart of the production planning function is the stock status file. The file operates similar in principle to the existing ABC Company system (Figure 49). Some changes, associated with the allocation of D.C. orders should be added, however, to obtain a more flexible planning tool.

The following lines can be used for 30 weeks on a weekly basis (Figure 50):-

PF = master schedule explosion
 SF = spares forecast
 TF = PF + SF
 O = works orders available (due in store by end of previous week)
 B = theoretical bin level

For week "n" , $B_n = B_{n-1} - TF_n + O_n$

and $B_0 = \text{BIN}$

where $\text{BIN} = \text{the current bin level}$

For three weeks on a weekly basis the following additional lines are required:-

ADO = items drawn off for assembly in the week concerned
 O = works order
 BS = projected true bin

Thus $BS_n = BS_{n-1} - ADO_n + O_n$

Thus two stock status files exist in essence

i) the forecast material requirements planning file for parts and

material ordering

- ii) the assembly draw-off record for allocation of D.C. orders against planned stock availability

In both records, the works orders are monitored. Any completions are deducted from the 0 line in the planned receipt week and added to the BIN. Losses and gains, which can be related to specific works orders (e.g. scrap) modify the 0 line and BIN as they occur. Unspecified losses and gains are taken off the BIN value at the next computer run.

The parts requirements shown on the stock status file would be date adjusted for the assembly and test lead time including the machining/assembly buffer. Stock status base data should include this information as well as the normal batch throughput time.

There should, of course, be a separate stock status file for each product centre.

8.9.2 WORKS ORDER CONTROL

The proposed works order control system covers the following routine aspects

- preparation and issue of the periodic works order lists, one per week or per cycle length applicable to the product centre concerned
- monitoring of diversion feedback from machining centres
- works order closure on receipt of stores advice note
- diversion reporting and works order closure loss/gain reporting

The works order list could be usefully prepared in the form of

a P.M.P. (Period Machining Programme) (79) (Figure 51), which shows all works orders for the period concerned in the recommended scheduling sequence.

Batch documentation would be issued to cover all batches on the P.M.P., with P.M.P. issue two weeks prior to machining cycle start. The machining cycle would, of course, be suitably advanced from the assembly/test cycle. The advance would be fixed for any one manufacturing centre and cover planned batch throughput time plus a suitable buffer to cover throughput time variations.

8.9.3 CAPACITY BALANCING

Capacity and backlog control is vital in a low inventory cellular manufacturing system. In particular the synchronisation of parallel running cells to support a common product centre programme needs to be monitored closely to ensure a high degree of delivery performance with low stock levels.

The capacity control system is based on a two-part analysis.

- i) each cell has a key machine (or set of interchangeable machines) designated. This key machine would generally be the most heavily loaded machine and should ideally be visited by every part in the centre. The machine load constraint is covered by ensuring that the available key machine capacity is not exceeded.
- ii) the total standard hours of the P.M.P. content are matched against the planned available labour, based on a historical average achievement of standard hours per man per day.

The capacity planning requires a data input of:

- a) key machine specification
 - type
 - quantity available
 - number of shifts
 - gross hours per day availability
 - net hours per day availability
- b) labour specification
 - quantity
 - standard hours achieved per man per day
- c) standard hours per part (as data attached to the work routing file)
- d) standard key machine hours per part

Progress data shown on the P.M.P. can be entered by the manufacturing cell personnel, and the level of backlog relative to the planning timetable is then used to modify the capacity planning of future cycles. It is unlikely that the P.M.P. can be efficiently matched to the precise length of the loading cycle and, in any case, actual production times will vary somewhat from standard. It is thus necessary to monitor any cycle shift relative to the planning base to adjust future programmes and labour requirements.

A typical procedure could be developed as follows:

Considering a programme of say 4 week length, with a planned throughput time of say, 3 weeks, the completed portion of the P.M.P. should go from 0 at three weeks after the start date to 100% after seven weeks.

Thus as a rough measure of backlog, one can measure P.M.P.

completion relative to planned throughput time. Counting piece parts only, one can compute on a weekly basis.

- a) the number of parts not completed by the end of their due week as a percentage of total weekly load (the number of weeks backlog)
- b) the number of parts completed for, say, the next four weeks ahead, for each week in turn, relative to their total weekly load (summed to give number of weeks forward build)

The backlog can be reported for management action. The sum of backlog and forward build is fed into the capacity analysis for P.M.P generation as the "net backlog". The most recent net backlog figure can be held in the work centre data file.

8.9.4 TECHNOLOGICAL SCHEDULING

It is suggested that Industrial Engineering study all parts produced by each manufacturing centre respectively and apply a simple code for scheduling purposes, of the following form - aa/bb/cc/dd, i.e.

- aa - 2-digit number denoting the product centre
- bb - 2-digit number denoting the manufacturing centre
- cc - 2-digit code denoting a family of parts where all parts in that family should be loaded together
- ddd - 3-digit sequential counter in preferred loading sequence

Thus 001 should be loaded first, followed by 002, followed by 003, etc.

Where several parts are grouped together, such that they should

be loaded as a family, they would be given the same family code (cc). If, for a number of parts the loading sequence is immaterial, they would have the same sequential counter (ddd). Figure 52 shows a typical example.

Industrial Engineering should specify

- a) setting times on the basis of the prescribed sequence for inclusion into work standards
- b) the machine(s) to which the priority sequence applies

Conflicting requirements may call for sequential loading on a high set-up machine to the detriment of low set-up machines.

8.9.5 BATCH QUANTITIES

The calculation of batch quantities can be pre-determined by the order cycle length. As discussed earlier, regular cycles used for all parts would normally be recommended, based on a single-phase-single-cycle, rota-cycle or any other cyclical method to satisfy the specific requirements of the manufacturing centre concerned. Batch quantity generation thus turns into a simple matter of stepping forward the relevant number of weeks on the stock status file and ordering quantities to bring the theoretical stocks up to safety stock level.

8.9.6 CYCLING DATA FILE

In a low inventory system, an even plant load must be planned to ensure that cyclical overloading and consequent delivery delays are minimised. One simple procedure uses a cycling data file as a

works order calendar, showing against each week the parts to be loaded. Since the system proposed works on a weekly cycle, weekly interrogation of the cycling data file is required for P.M.P. generation. For those centres not having any parts listed against a specific week, no P.M.P. would be issued for that week. This simple procedure allows for different cycling arrangements in different manufacturing centres.

Typically, an annual file establishment could be used, though more frequent updating is, of course, possible where changing conditions demand it.

The file structure is pictorially shown as follows:

Part No.	Mfg. Centre	Week Number				
		1	2	3	4	5 etc
213417	01/01	x			x	
213418	02/05	x	x	x	x	x
213419	01/01		x			x
213422	03/02	x		x		x
etc.						

The 'x' indicates that the week concerned is a batch loading week, i.e. the part concerned is to be included in the P.M.P. for that week. The load pattern can be drawn up by intuition, trial and error, or more sophisticated algorithms. A high degree of accuracy would not be required, since the calendar is based on a projected annual demand, which would normally be expected to change in time.

8.9.7 P.M.P. GENERATION

Figure 53 illustrates a typical process of P.M.P. generation by

computer. It is in keeping with the production mode, discussed earlier, that a computer should be used for all routine activities, utilising people to deal with exceptions, problems, etc.

To start P.M.P. generation, each in-house stock status item is read, complete with forward and standard data. The stock status item is matched against the cycle data file and if it is to be loaded in the designated programme week, the net requirements are calculated and filed. At the same time, a test is made on parts not called up in the cycle data file that week to find parts which will run into shortages within their lead time or the subsequent week and must be included in the current period's P.M.P.

Necessary print-outs would be

- i) a P.M.P. for each manufacturing centre
- ii) a report of labour and machine utilisation for management information
- iii) a report of items which cannot be loaded due to tooling or material shortages

8.9.8 WORKS ORDER DOCUMENTATION

The Works Order Documentation could reduce to the following items:

- i) P.M.P
- ii) Material requisition
- iii) Route and inspection card
- iv) Work container identification

Items (i), (ii) and (iii) would be issued by Production Planning and

(iv) by each manufacturing cell as required.

8.9.9 RECTIFICATION

To give each cell a full accountability over its reject work, it is proposed that prior to P.M.P. generation, information on the number of rectifiable parts in the cell is extracted from the stock status file. The material requisition is reduced by this quantity, but the total demand quoted on the P.M.P. includes the rectifiable work.

Rectification would thus be treated as total loss when taken off the line, and the cell would not be credited with its value until re-introduced as work-in-progress during the next cycle.

8.9.10 DIVERSIONS

To ensure adequate overall planning control, it is required that diversions (i.e. losses or gains including rectification) are fed back to the production planning function at the time of discovery to ensure stock status file accuracy.

Diversion notes can be used to update the projected works order receipts and bin levels on the stock status file, and will thus immediately reflect on the allocation routine.

8.9.11 PURCHASE ORDERS

Purchased and sub-contracted parts need to be segregated on the stock status file. A print copy would be supplied to purchasing, segregated into sets for individual buyers, utilising buyer codes. Each buyer would be responsible for placing his own orders to stock

status demand.

To fulfill the requirements for work centre accountability, exception listings highlighting over and under stock situations need to be supplied to each product centre production planner together with a listing of all purchase orders. The production planner should have the prerogative to direct purchasing on batch quantities or planned override of the computer-prepared projected stock requirements.

8.9.12 ORDER ENTRY AND ASSEMBLY DRAW-OFF

As indicated earlier, the success of the proposed manufacturing system hinges on the matching of orders to available capacity. It is thus essential to allocate D.C. orders to the forecast. Since the forecast is based on historical mix, some deviation between forecast and actual demand at a piece part level must be expected, which is covered by calculated parts safety stocks.

Order entry is thus concerned with matching orders against the stock status file and confirm or adjust the delivery requirement. Since actual order intake parts requirement may differ somewhat from the forecast explosion, a part-by-part allocation would be required.

Parts allocation can be simply a case of exploding each D.C. order into its constituent parts and deducting the parts from the order line of the stock status file. Over-allocation within safety stock limits would be acceptable of course.

As D.C. orders are matched against the stock status file, items which are successfully allocated can be immediately deducted from the stock status file, at the same time as assembly documentation is produced. Failure to allocate would move the item concerned into

a D.C. return file.

The following procedure is proposed in this text, based on Figure 54:-

Every week the D.C. supplies firm orders to manufacturing with a due date four weeks ahead, i.e. at the beginning of the week 'x' , D.C. orders for delivery in week ('x' + 4) are received. Orders are added to the Assembly work-in-progress File.

Assembly draw-off (A.D.O.) takes place by product centre, to a priority code system. Priority codes to be supplied with each D.C. order are suggested as follows using a four digit priority code:-

1st digit	:	numerical priority
2nd & 3rd digit	:	due week
4th digit	:	due year (i.e. 8 = 1978)

The first digit may be simply built up as follows:

- 1 - priority above all other units, but all 1- units drawn within due date order
- 2 - after 1 priority, 2-items have priority within their due week, but older outstanding units have priority
- 3 - all other units

Thus the A.D.O. file can be sorted into the following order

Product group 1:-

- All priority 1 in due date order
- All priority 2 and 3 combined in due date order
- Within each due week, all 2- priorities, followed by all 3- priorities

- Within each priority number, sorted by assembly number sequence

Product Group 2:-

repeat

etc.

Draw-off would be arranged in strict A.D.O. file sequence.

Referring to Figure 55, assuming a total weekly assembly build programme throughput time of three weeks, then the draw-off for, say, week 5 takes place one week earlier than required. All draw-off documentation would be passed to the assembly centre, who would hold, at the beginning of each week,

- a) the week's assembly programme.
- b) the following week's programme
- c) any other programmes work not yet completed

Thus the assembly centre would have its programme clearly defined, but would retain some degree of flexibility for work loading. In general, since the draw-off priorities are pre-defined, the assembly cells should assemble in draw-off sequence.

The draw-off procedure must for each product group sum cumulative assembly hours. Thus each unit on the D.C. order file needs to be tagged with its product centre code and its standard assembly hours.

A weekly print-out of total assembly hour requirements would be issued to the assembly centre supervisor for his labour demand analysis. Monitoring reports are suggested as follows:

- a) the number of overdue units due to parts and capacity shortage
(sum total allocation failure)

- b) the assembly backlog
(weekly review of assembly work-in-progress file to list all units behind schedule; also total unit quantity standard hours backlog)
- c) the assembly forward build
(number of units built ahead of schedule in any one week, as a percentage of the next week's programme)
- d) the assembly work-in-progress level
- e) the relationship of the production programme to assembly output
i.e. the weekly and annual cumulative ratio of units built to units forecast
 - by unit quantity
 - by standard hours

Items (b), (c) and (d) could be determined from a log of transfer notes from product centres to the D.C. warehouse. A weekly transaction run would update the assembly work-in-progress file and obtain the monitoring data.

8.9.13 STOCK CONTROL

A recent analysis in the ABC Company showed that using a Pareto analysis, the following stock value distribution existed:-

Classification	% part numbers	% annual usage value
A	1.5	36.4
B	2.2	16.4
C	4.4	16.4
D	5.5	7.7
E	60.0	9.3
Others	26.4	13.8
	<hr/>	<hr/>
	100.0	100.0

The Pareto distribution was very clearly defined (i.e. 13.6% of all parts use 76.9% of total revenue).

Furthermore, A and B parts were predominantly in-house items, where close control and good material requirements planning could be applied.

To balance control effort with control cost, it would suggest itself, to use different control systems for different value items such as A, B, C & D items : material requirements planning
 E items : sealed-bin control

Raw material and long lead time items could be controlled by re-order point (A, B, C & D) or sealed-bin control (E).

8.9.14 STOCK STATUS UPDATE

In the system described, there is no facility for checking actual stock records. The total number of finished parts in the product centre for any one part number is known to be the BIN value on the stock status file plus the assembly work-in-progress. If an unexpected shortage of parts occurs, however, a stock check is required to re-establish the true BIN condition.

It can be shown that

$$\text{bin level in store} + \text{parts in assembly} = \text{BIN} + \text{parts in assembly}$$

work-in-progress file

also,

$$\text{parts in assembly} + \text{picking lists held ready for picking}$$

$$= \text{parts in assembly work-in-progress file}$$

Thus

$$\text{BIN} = \text{Bin level in store} - \text{parts on picking lists issued but not yet picked.}$$

Thus, to determine the correct BIN level, it is necessary to check the stores bin and add to that all parts of the same part number on picking lists issued for A.D.O. but not yet picked.

The BIN level on the stock status is deducted from the sum of the stock level in store and the outstanding picking lists, and the resultant value is entered as an unspecified diversion.

8.9.15 THE STORES FUNCTION

The finished part store should be decentralised, with in-house made parts held within each product centre, together with other product related A, B, C and D parts.

A centralised store should be used

- a) as back-up store for items purchased or made in large quantities, prohibiting on-line storage
- b) as a store for E parts. Small open stocks of E parts can be maintained in each work centre; typically two weeks normal usage. When stock falls down close to zero, the work centre would request a replenishment. Tables of replenishment quantities would be

drawn up by Production Planning and issued to the central store.

8.10 PRODUCTION CONTROL

The production control function should, to support the proposed production mode, be largely an informal activity, where the work centre personnel control the execution of their work.

In general, for each machining cell, on receipt of each period's P.M.P., it would be posted in the machining centre. The supervisor would hold material requisitions and pass them to the material store supervisor 2 to 4 days prior to requirement. The material store supervisor who is responsible for delivering material to the work centre, would use a centralised materials handling service. On material receipt, the work centre supervisor would agree the correct quantity and pass the requisition to accounts.

Tooling not already held in the centre needs to be requested from the central store in good time. No formal responsibility should be assigned, and one would anticipate that each supervisor would make his own arrangements with his staff to ensure that tools are provided for each operation in good time.

Whilst operators are, of course, floating, each machine should be assigned to an operator or setter, with responsibility for setting up his machines. A back-up setter for each machine must be assigned to allow good flexibility. The "first line" setter could delegate setting to his back-up setter, but he would, at all times, be responsible for his machines and tooling. By making centre personnel responsible for equipment and associated tooling, it would be anticipated that a higher degree of job responsibility would be built up.

Each batch would be identified with a batch card, which would accompany the material, i.e.

- be placed with material on receipt in the machining cell
- accompany the first box of each batch through the processing line
- act as finished goods transfer note between the cell and external services, as well as the finished part store respectively.

At each transfer point, the quantity transferred would be signed off by a cell member and a "transfer note" filed.

On leaving the centre after the final operation, the time and quantity would be signed off on the P.M.P. Transfer notes could be filed for any necessary analysis of delays on external services.

Individual operation booking would, of course, be discontinued.

8.11 QUALITY CONTROL

In the ABC Company the quality control system was established along conventional lines, i.e.

- centralised quality control with inspectors reporting to the central function
- scrap and reject measured against specific operators
- operators' quality checked by inspectors
- rectification control by central administrative service

The execution of quality control functions in autonomous work centres has been tested in G.T. applications and, in keeping with the production mode proposed, the following organisation could be applied:

- 1) a centralised quality assurance function is maintained, responsible for

- quality standard and procedures
 - assisting work centres in scrap and reject analysis
 - developing in conjunction with work centres, new inspection techniques
 - advising centres on inspection and test equipment requirements
 - acting as company management standards and reference authority
 - providing an audit service in cases of abnormal quality deterioration, used as "emergency" measure by plant management or as audit request by the work centre itself
 - providing a periodic quality audit to satisfy plant management that policy quality levels are maintained.
- ii) all inspection and test activities are contained within each product centre.

The deviation from normal practice is conditional on the autonomous work centre concept, where the quality audit trail is clearly defined and all quality problems can be easily traced to their sources. There can be no hard and fast rules on inspection manning. Inspection may be an operator function, specialist inspector function, or a combination of both. One would anticipate line inspectors to be used at critical points in the process sequence initially, but routine inspection duties are over a period of time to be transferred to operators, with inspectors re-deployed. Product group managers would need to develop their own policies in this area. Overriding principles are, however, that

- product managers are responsible for the assignment of inspectors
 - operator inspection is to be developed progressively, and specialist inspectors transferred to other activities
 - product managers are charged with the cost of inspectors to give a good incentive to phase out this activity
- iii) Scrap and rework are charged against the work centre concerned
- a) directly by monitoring the cost of scrap via scrap notes
 - b) indirectly by loss of work centre output relative to resource input

The latter principle is attractive for its ease of manipulation. The accounting procedures for scrap could be minimised and rectification automatically corrected in the accounting system as rectified parts are issued from the cell.

- iv) scrap and reject accounting uses a procedure where
- on reject, a scrap note is made out by a resident work centre inspector, specifying scrap or rectification
 - scrap note copies are sent to accounts and costed, to calculate the monthly scrap value
 - copies of all reject notes are sent to quality control for analysis
 - all rectifiable work is set aside. If found unrectifiable at a later stage, the reject note is modified to indicate scrap and treated as a scrap note
 - rectifiable work is processed with the next batch, thus increasing the next batch quantity

- copies of all scrap and reject notes are passed to production planning and fed into the stock status file, to reduce theoretical stocks by the scrap and rectification work, and record the rectification quantity.

The rectification quantity would be automatically noted on the next period machining programme and the material requirement correspondingly reduced.

A weekly scrap/rectification report could be issued and reviewed in a meeting by work centre and production planning personnel, to assess the effect on assembly programmes and necessary action, where supply problems exist.

- where work is required to make good rejected parts, requiring the services of other work centres (e.g. toolroom) the work centre supervisor requiring the repair work can negotiate a "price" (i.e. hours) with the supervisor providing the service, and issue an "order". The centre which produced the reject would be debited with these hours and the repair work centre credited accordingly. In case of dispute, the Industrial Engineering Manager or his designated staff member could arbitrate. Repair time should be to a standard lead time (e.g. two weeks), unless overload conditions demand a re-definition of this period. From the delivery period and the work issue date, the centre supervisor can check if the work will be available in the next order cycle for that part
- it will be noted that in this procedure, rectification is, from an accounting point of view, treated as long lead time work and not considered unless it is later rejected,

in which case, it is added to the scrap account.

One would expect the above procedures to provide adequate control over the quality function, but still allow the removal of oppressive external control to a large extent. It is recognised these days that prevention, rather than detection of faults is essential in an effective manufacturing environment. Traditional inspection has no preventive element in it, other than perhaps the Theory "x" element of oppressive threat of sanction. To obtain true preventive inspection, the responsibility, training and equipment for inspection must be given to the person producing the goods, i.e. the operator. Such an argument is, of course, totally in accord with modern day attitudes towards job enrichment.

Ferranti Limited (87) have used a system, where all routine inspection is delegated to operators and line inspectors are only used to check at certain specific points, where particularly critical conditions exist. A sample check on completed components takes place when a batch leaves the machining centre. Herbert Limited have established (86), that only 21% of scrap cost is due to operator error and the remainder to tooling, gauging, specification, etc. A group working environment with delegated quality control is much more likely to deal with the technical scrap reasons and the reduced feedback link through operator inspection will highlight problems early. Research has shown that in a survey across 23 companies (86), there was an inverse relationship between quality cost per unit sales and inspectors per number of operators. As a result of such deliberations, Herbert Limited have reduced their inspector/operator ratio from 1:9 to 1:13. A significant reduction in scrap and rework was achieved

by introducing operator inspection in conjunction with a cellular shop layout.

The point is made that operator inspection requires fully productionised inspection procedures in terms of

- planned inspection operations
- full inspection data on planning sheets
- provision of all necessary gauges

Rank Xerox Limited (105), operating in a G.T. environment quote the following hierarchy of quality control effectiveness

- automatic control
- instant warning control
- operator control
- inspection control

They recognise the low motivational effect of inspection and favour operator or process control of quality.

9. DISCUSSION

9.1 INTEGRATION IN SYSTEMS DESIGN

One of the main themes of this thesis is the need for the proper recognition and subsequent integration of all constituent elements in a systems design.

When striving for some degree of systems optimisation, it must be ensured that all factors are considered. There is little point in optimising specific systems elements to the detriment of overall systems performance. "The complexity of systems design factors and their interactions and interdependencies means that searches for solutions involve many trade-off considerations which are highly probabilistic in nature" (20). There is probably little to be gained in attempting systems optimisation in any case. Any practical business environment is so complex, that it is impossible to determine analytically an optimum solution. Systems analysis and simulation are useful tools, to learn to understand the inter-relationship of variables, but it is unlikely that they can ever provide a composite model of a corporation.

This is not a condemnation of scientific management, of course, and the analytical tools available should be applied to their fullest extent where possible. For a practical systems design, however, even where complex models are applied for the solution of specific problems, one is more likely to strive for a workable solution which balances the various factors such as technology, human requirements, market demand, etc. in an acceptable manner, giving better performance than is achieved by the competition.

There has been, in industry, an appreciation of the need for

systems thinking to achieve acceptable integration within manageable complexity. In practice, however, there appears to be a lack of truly integrated business systems for manufacturing companies.

Serck Audco Limited (8) developed a fair integrated business system, but largely ignored the human sub-system. Motivational benefits were mainly a side-benefit of the group working mode. There had been no conscious effort, however, to integrate the human sub-system.

H.B. Maynard Limited (27) have developed useful concepts for integrating the technological manufacturing aspects with behavioural sciences, and quote examples of companies, who have dealt with this area, generally under the heading of group working. Again, of course, only one aspect of integration is covered.

Arn (29) covers the integration of design and manufacturing. He draws heavily on systems theory to develop his concepts, which are restricted to basically two elements with one interface.

Ferodo (9) seem to have gone further, and have considered the relationship between technology, administration, organisation, and, to a lesser degree, human aspects. The project in its limited sphere appears to be potentially the most comprehensive systems design in U.K. manufacturing, but has not been extended to cover the business system as a whole.

It appears that Volvo (106) have progressed further in the overall systems design, linking technology, administration and people into a truly novel manufacturing systems design, though their use of systems theory is not mentioned in the literature.

The report presented in this thesis covers a "first principles" design for a manufacturing system. The key aspects not generally

covered by other workers are:-

- the definition of systems elements and their boundaries
- a consideration of the inter-relationship of different business sub-systems, and the clear identification of
 - a) the scope of the manufacturing system
 - b) its boundaries
 - c) its interface requirements within the individual manufacturing systems elements i.e. technology
 - administration
 - people

The study concentrates on the administrative and human sub-system, but the technological sub-system is discussed. In the Company reviewed, much of the latter was previously designed in a manner, compatible with the production mode defined, and less work was required in this area.

The manufacturing-design interface and the marketing impact on the product and technology have not been discussed. These areas have a long term effect on overall business development but could be largely neglected within the manufacturing systems design in an inherently stable business. There is, of course, a constant interchange between design, marketing and manufacturing, to ensure that the manufacturing system is compatible with long term business goals.

Two main techniques to deal with organisational integration have been used:-

- i) where the system can be split vertically (i.e. the manufacturing system into parallel product groups), the establishment of autonomous sub-systems with minimal connectives has been

recommended. Accepting that integration problems are more difficult to overcome, as the interface pattern between systems elements becomes more complex, the need for interface activities has been minimised.

- ii) where such a vertical split is not possible (e.g. between marketing and manufacturing), a concept of the "resolved conflict" organisation has been suggested. It has been assumed, that parochialism between functional departments is significantly promoted by conflicting objectives between them. Thus conflict resolution has been put forward as a major criterion of formalised organisation design. Wherever possible, conflict was concentrated within one functional area, such that the manager concerned had the task to resolve the conflict internally. The conflict between line and staff functions was minimised, by making the line function (e.g. the product centre) responsible for measurable plant output, and removing from the staff function (e.g. Industrial Engineering) the authority to dictate operating parameters to the line function. The staff function, whose objectives may well conflict with the line function, is thus forced to take a back seat. Conversely, the line function, lacking expert knowledge, is forced to utilise the services of the staff function. The staff acts as adviser and assistant, not as "policeman", and, as McGregor (107) discussed, a major line/staff conflict source is removed.

The use of operating committees has been recommended to improve integration within the need of differentiation. Utilising the concept of group activity in a task orientated committee structure as

suggested by Likert (24), integration can be achieved for groups of specialists from different areas. A company will need to develop two organisation structures: firstly, a conventional task-based structure to define internal departments' responsibilities and worker assignment and, secondly, a committee structure to cover the inter-departmental activities. Both structures must be developed together, and must jointly cover the tasks to be performed by the organisation.

9.2 THE "NEW" APPROACH TO MANUFACTURING SYSTEMS DESIGN

The manufacturing systems design methodology employed in this study differs from the conventional approach by:-

- i) its high priority of human aspects
- ii) its relationship to the overall business system.

The systems analysis is based on three studies:-

- i) an analysis of the existing manufacturing system
- ii) a survey of behavioural sciences and their impact on the system
- iii) a comprehensive survey of the constraints, such as
 - product
 - market requirements
 - economic constraints
 - company policies and objectives
 - company strength and weakness analysis

Combining the three studies, it was possible to draw up a production mode, which would successfully satisfy the overall requirements of the business.

Often in manufacturing systems design, the need for the overall analysis is insufficiently considered, and a sub-optimal solution is derived.

The need for feedback between the different systems design elements has been stressed. Parochialism is the greatest threat to a well balanced systems design, and such areas as layout, technology, administrative procedures, etc. must not be developed in isolation, but must conform to the overall requirements of the production mode.

In a broader sense, the role of Manufacturing within the overall business must be analysed. "... research shows that few companies do in fact carefully and explicitly tailor their production systems to perform the tasks which are vital to corporate success." (26). The "new" approach to manufacturing systems analysis demands that the overall business environment of the company is analysed. Ideally, the manufacturing systems parameters will emerge as a logical conclusion of the objectives, demands and constraints of the business.

9.3 THE PRODUCTION MODE

Integrated business systems design and implementation is from necessity a complex project, requiring considerable resources across a wide range of specialist skills. Thus project integration is as much a problem as systems integration.

The production mode within the concept of this study, proved to be a useful tool for project integration. It may be regarded as the policy/strategy statement, on the basis of which detailed plans are developed and implemented. It is a problem in a major project with new conceptual aspects, that end users and individual members of the

project team lose the overview, and do not fully appreciate the overall directive. The production mode acts as the linking document, and must detail the philosophy and strategy of the project in sufficient detail to allow individual functional specialists to appreciate their role within the overall structure.

The production mode can be prepared within reasonable cost levels and typically, one man year may be adequate for a medium sized plant. Once the report has been prepared, management can judge its merit, and, if felt to be acceptable, give their authorisation to proceed with implementation.

A detailed and board-approved production mode is the project manager's life line, and without a system of that kind, he could find it difficult to maintain management commitment and clear communication to specialist implementation teams.

One might consider, that the preparation of a production mode, in conjunction with its current-situation-review, is a useful exercise in its own right. Technical and social advances are rapid and a company's internal and external operating conditions change. Thus, periodically, say every 5 to 10 years, the preparation of a production mode statement can be strongly recommended as a major strategic planning tool.

The development of the mode, as discussed, avoids to some degree the pitfall of squeezing a company into a stereo-typed system, such as functional layout, G.T. or flow line production.

Whilst companies have had considerable success in applying G.T. as such (108), the production system should be a logical outcome of a theoretical analysis, and utilise those techniques, most appropriate

to the situation under study. Rathmill (103), applying his G.T. acceptability criteria, might probably regard the ABC Company as an ideal candidate for G.T., but to use G.T. as an unquestioned philosophy would be an unscientific approach. Rathmill's work is conceptually not too useful for manufacturing systems design, since it merely balances the merit of two stereo type systems. There is little benefit in knowing that a company is suitable for G.T. if one does not understand what that knowledge entails. It is claimed in this thesis, that the correct approach is to study the system objectively and apply those management techniques most appropriate to the case in hand.

It should be noted that the ABC Company promoted this study under the general umbrella of G.T. This is not really a contradiction of the argument above. It was realised at an early stage that work grouping would be a dominant feature of the production mode. Indeed, many workers would doubtlessly label the proposed production mode a model G.T. application. At the same time, it has, beyond a cellular layout, little in common with most practical G.T. installations in the field and has not gone through the normal circuit of G.T. analysis.

9.4 HUMAN ASPECTS

9.4.1 THE SOCIO-TECHNICAL REVOLUTION

Before the turn of the century, Western Europe experienced the so-called industrial revolution. The economic climate of capitalism was increasingly developed. Exploitation was an acceptable moral value, and entrepreneurial qualities were held in high esteem.

Employees, shop workers in particular, were largely motivated by primary need satisfaction. The quest for productivity led from the increasing appreciation of Adam Smith's division of labour to the scientific study of work. Modern work study is still largely based on such purely technological analysis of work.

Industrialised nations are now in the early phases of what one may call the socio-technological revolution, where the striving for increasing productivity needs to be modified by sociological aspects to fulfill the requirements for higher need satisfaction.

The production mode discussed above, draws heavily on the research of behavioural scientists, to develop the human sub-system. It is recognised today, that companies need to demonstrate a social conscience in their operating methods. The profit motive, whilst still important, of course, must be moderated by social objectives. Failure to observe these will lead to labour unrest, poor motivation, disruption, high turnover, or, if practiced by a larger sector of industry, social legislation.

A more socially aware industrial society demands that human values are observed, both internally and externally in a company's operating strategy.

The internal objective is to fulfill those aspects most conducive to job satisfaction, such as listed by Scanlon (109):-

- i) participative supervision (decision delegation)
- ii) opportunity to interact with peers (e.g. group management structure)
- iii) varied duties (job enrichment, blurring of traditional job boundaries)

- iv) high pay (by improved productivity)
- v) promotional opportunity (greater personal skill development, better exposure to supervisors in decision making)
- vi) control over work methods and pace (participation in methods development)

In general, the production mode described earlier, allows for the achievement of these objectives. Most of the aspects of behavioural science quoted in this study are not new, but at the same time there appears to be little published application of these principles in this country. Most studies are based on limited field work. As Pullen (110) indicates, in numerous G.T. projects in the U.K., there has been a disappointing level of concern for human needs.

9.4.2 A PROBLEM OF CHANGE

The human problems have rarely been considered in integrated manufacturing systems design to date, but their impact changes some of our basic concepts. There is no doubt that physiological and safety needs have not yet been fully conquered and certainly are not seen as conquered by operators. Fear of reprisals is still very great, be it fear of exploitation, rate cutting or loss of job, either through redundancy caused by productivity improvements or through dismissal for poor performance (111). The problems in setting up an industrial environment which leads towards greater need fulfilment are considerable. On the one hand, there is a need to go through a complex programme of attitude changing for managers and operators alike, which is expensive and time consuming; on the other

hand, one must remove the individual threat of sanctions by management and transfer the performance control to groups, relying on group attitudes to deal with specific individuals' poor performance. Most difficult of all, it is essential to remove the threat of dismissal as a result of increased output per man, or, if that is impossible, make the work-force reduction painless enough, to avoid artificial productivity restrictions. Coupled with the above points is the need to overcome ideological problems, possibly by promoting worker participation both in decision making processes and in reward distribution. It seems almost impossible to achieve such a change within one single commercial plant and it is unlikely that a manufacturing systems design, fully utilising existing knowledge of industrial sociology and psychology, will yield the desired results. Indeed, it is likely that too radical a change in too short a time would yield disastrous results in terms of management's inability to cope, and their subsequent disillusionment, as well as labour's probable tendency to take advantage of the lack of control to reduce productivity in order to improve apparent job security.

Whilst the overriding principles of an improved working environment must be adhered to, it is essential that the actual systems implementation will be gradual over a number of years, as execution and control is increasingly delegated to lower operating levels. Such a procedure does, of course, suffer from the added problem, that in an academic and commercial sense, the systems design and implementation is to some degree an act of faith, based on research results from a range of limited studies, and theoretical analysis provided in the literature. There is, however, sufficient research available to

indicate a set of "rules" for sound manufacturing systems design. One should be aware of these "rules", even if the implementation may draw out over a number of years. Administrative and technological sub-systems must be designed to accommodate a smooth transition from current autocratic/paternalistic management styles to a participative industrial environment, accepting the continuing need to provide output at an economical rate in a competitive society.

Taylorism, as a means of improving productivity is increasingly unacceptable, but this must not prevent a plant from operating in an efficient manner. Companies are thus faced with a massive training programme, teaching all operators the awareness and techniques of technologically effective working. Operators must be inherently able to do work in a rational manner and be trained to recognise efficient work procedures. If one cannot apply current methods of drilling a narrow range of closely defined "good" methods into an operator, the operator must be his own "methods engineer". Work study training and "self-analysis" group discussions are required at operator level to instill this "good methods awareness".

There must, furthermore, be reward for effort and such reward should be ego-building. Initially, there are financial incentives, which cannot, of course, be in terms of individual performance incentives, but must be based on group performance. Further research is required, but one can envisage such procedures as group-based measured day work, with group increases due to productivity improvement shared out on a point system, allocated by group discussion and ballot.

Status incentives have been used within the Company to date, such as the allocation of prominent car park spaces, and news letters on

the notice board making special achievements known to others.

Other status incentives can be thought up, to provide real satisfaction from enhanced performance.

Once a well motivated work force has been established, operating responsibly and effectively, delegation and participation can become a reality for meaningful plant management.

In the meantime, emotional problems amongst employees should be recognised, where there is a trend towards higher needs satisfaction, without security for maintenance of lower needs fulfilment. There is likely to be "irrational" behaviour at times where employees' demands are torn between the need for self-actualisation and the necessity to ensure the maintenance of achieved primary needs (112).

9.4.3 A NEED FOR COMPROMISE

The problem is, of course, to design a system to meet future demands, but at the same time including the basic control and motivating elements acceptable to today's industrial society such as

- the use of a formal organisation structure with a defined hierarchy of decision making
- the use of performance measurement, but shifted from the individual to the group to minimise fear elements
- the use of incentive schemes

Whilst Galbraith (113) may talk about the futility of increasing productivity, it is today's economic fact that survival of the commercial enterprise depends to a major extent on its cost effectiveness. Thus the benefits of division of labour and the use of

methods of high repetition cannot be lost overnight. The manufacturing system proposed in this thesis provides one solution to bridge the gap into the socially more demanding future.

Currently, the industrial society is firmly divided depending on specific personal attitudes. The relevant literature is generally either conservative or progressive, with little in-between. Well respected researchers (114) for example, condemn the growing enthusiasm for G.T. by stressing conventional technological values, and failing to understand the more far-reaching issues.

The bridge between worker and owner (or his "servant", the manager) is wide (115) and will not be bridged in a hurry. Change thus calls for systems design, which largely accepts current values, but provides the correct environment, able to adjust, as attitude changes amongst managers and workers alike permit changes.

Mention has been made by Merchant (116) of the trend towards an automated manufacturing plant, and indeed, advanced plans exist in Japan for the "unmanned factory" (117). This trend will lead to a reducing need for direct operators as we know them today and many of the concepts of Taylorism in work measurement and performance control will become largely irrelevant. Already today, the direct/indirect labour ratio is usually so large (118) and so much of direct operator time machine controlled, that time study is of doubtful value in many environments. Group output measurement and Scanlon-plan-type incentive systems (119) are probably more appropriate in most cases.

The scope of CAM and DNC will doubtlessly extend (120), and the direct operator as an integral part of the producing man-machine system will become obsolete. The operator of the future will be a

process controller and, as such, will not be linked to specific output units. The proposed production mode, therefore, helps to bridge the technological revolution to full automation.

The integration of advanced technological concepts such as CNC leading to DNC, Industrial Robots and computer-aided production control (121) makes the above concepts feasible. High level languages and conversational computer-aided manufacturing systems reduce the need for day-to-day supervision of the manufacturing system by highly trained staff specialists. Advanced techniques can thus be utilised by relatively untrained personnel with full confidence, and the conflict between advanced systems utilisation and delegation of operational control to the shop can be solved.

9.4.4 DELEGATION OF RESPONSIBILITY

Job enrichment through participation and delegation of responsibility is one of the aims of the proposed production mode. The following key elements to achieve these aims were applied in this study:-

i) at shop level:-

- a removal of all formalised scheduling and progress activity
- a better job identification by working to assembly - related monthly work programmes
- a work centre-based accountability for all output aspects such as delivery, tool control and inspection
- a reduction of frustration by checking capacity, material and tooling availability prior to works order issue

ii) at administrative level:-

- a narrower but deeper job accountability
- output related task assignment in material control areas, giving individuals a broad control task within a narrow product range

iii) at management level:-

- a clear accountability for task achievement with minimal external activity impact
- a feeling of being fully "in charge" of task achievement
- a knowledge that achievement is feasible and tasks are matched to resource availability

iv) for overall co-ordination:-

- the participation in activities across normal job boundaries within committee activities
- the establishment of better co-operation between operating and staff activities by joint (committee) task fulfilment.

It is believed that these measures will significantly improve job satisfaction and provide the basis for a happier, more fulfilled work activity for employees at all levels. Furthermore, they are likely to raise, rather than lower the quality of decision making, since at present often "those who have the necessary information, do not have the power to decide, and those who have the power to decide, cannot get the necessary information". (122).

9.4.5 EASING THE MONOTONY OF WORK

The enemy of job enrichment in the production environment is the monotony of repetitive work. The proposed production mode can make major improvements in this area. The team spirit and goal identification inherent in the cellular manufacturing system will make some degree of monotony acceptable as an unavoidable chore in the execution of the common task. For example, there may be little inherent enjoyment in digging a garden or preparing circulars for the church bazaar, but the satisfaction of task fulfilment largely overcomes the unpleasantness of the detailed execution.

The job enrichment aspects help to ease the monotony in any case. The floating labour concept, the greater depth of activity for production control members, etc. relieve the monotony by avoiding to some degree the prolonged periods of total repetition. One can only guess at the production loss currently caused by employees, direct as well as indirect, discussing and debating issues unnecessarily, assuming they are solving vital problems, but in reality seeking relief from boredom. (123)

The proposals for flexible automation, notably the use of robots, reduce the need for routine activities such as loading and unloading. As such techniques are further developed, and the machine operator turns more into a process controller, a significant improvement in job satisfaction and greatly reduced monotony must result.

9.4.6 A SIMPLIFIED OPERATING ENVIRONMENT

The cost benefit of a flexible organisation with far reaching delegation to lower operating levels is often overlooked. As Collino

(124) points out.

"A complex, highly integrated production process may reduce direct labour to a low value, but the indirect cost in planning the facility, scheduling material and parts, line balancing, maintenance and other support effort is often inadequately estimated - if at all".

An inherent simplicity of the manufacturing system is essential to bridge the socio-technological revolution. It is likely that future generations will be better trained and educated, but initially we must match our task distribution to our labour capability distribution. Thus, before delegating decisions in the current technological environment, it must be ensured that shop personnel with average training and intellect will be able to cope. Current manufacturing systems can hardly be understood by highly trained specialists. To hand decision making in such systems to people insufficiently trained would border on criminal negligence.

Thus work centres must be simple and small, tasks must be clearly defined, and objectives must be easily understood. Trained experts in staff support groups must be available, but they in turn must be trained to properly adapt to their role of guiding and supporting the line function (107).

9.5 EFFECTIVENESS OF THE PROPOSED PRODUCTION MODE

9.5.1 OBJECTIVE SATISFACTION

The criterion of the effectiveness of the proposed production mode is, of course, the degree to which it overcomes the weaknesses of the existing system. Examining each one in turn, the degree of success can be assessed, partially by reference to a pilot cell

(Appendix II), and partially by subjective judgement.

Demand fluctuations

The demand fluctuations have caused significant demand amplification in the past due to:-

- ineffective forecasting
- divided and unco-ordinated stocking points (i.e. a number of marketing warehouses in the field)
- long manufacturing lead times
- lack of capacity balancing for component works orders, leading to stock imbalance during excess demand periods

The former two items have been dealt with by marketing studies, and the latter two items have been considered in this thesis. Table V shows the comparison of lead times, based on average estimated against planned theoretical lead times in response to a new order. A reduction of 28% in total lead time and 61% in production time ignoring material procurement can be seen.

The example is somewhat artificial, since the practice deals with order fulfilment to forecast. The example does, however, illustrate the effect of unforecast demand change and the reduction is representative of the phase lag between demand fluctuation and manufacturing follow-up. The need for high material stocks is illustrated, since the reduction is in areas other than material procurement.

The example furthermore shows the possible reduction in forecasting horizon. With a four-weekly forecast, the mean proposed lead time between forecast and order supply is around 8 weeks, or about half of the current response time.

A penalty is incurred in the proposed production mode, where in the fixed cycle ordering system, on average half the order cycle length must be added to the mean lead time. Thus short order cycles, ideally not in excess of four weeks for high volume units must be used to avoid that the lead time reduction is seriously eroded.

It is appreciated that for low volume items the cycle time and hence effective lead time will be longer, but this will not have a significant effect on the overall business volume.

Productivity

An attempt has been made in the proposed production mode, to deal with productivity through improved motivation and greater personal commitment to the set task. There is currently significant work taking place within the ABC Company to look at the areas of performance measurement, sharing of productivity gains and manufacturing development. It is expected, that productivity will improve as a combination of these, i.e.

- better motivation will improve personnel effectiveness
- reduced administrative complexity will reduce communication time
- manufacturing research will improve the manufacturing technology
- increased automation will reduce monotony and labour-paced output limitations
- a performance monitoring system will provide a basis for increased earnings

It is anticipated that the "package" will have significant effect. Experience in the pilot cell (Appendix II) has shown that significant

improvements in operator efficiency and methods can be achieved with small effort. Providing the ABC Company maintains credibility by an equitable sharing of improvements, much greater benefits must be achieved.

Set-up cost

There has been some significant reduction in standard set-up times in the pilot cell using technological sequencing. The maximum set-up reduction quoted in Appendix II represents around 1% productivity improvement. In itself fairly insignificant, it shows the potential available with greater industrial engineering effort. This area has not yet received sufficient attention in this project.

Improved manageability

Experience in the ABC Company on improved manageability was limited to the pilot cell, where delegation of the scheduling and progress has significantly reduced progress effort with improved delivery performance. No quantitative information is available, but there is no doubt that the formal progress function can be abandoned in flexible flow lines.

The further improvements in manageability due to the federal organisation and responsibility delegation cannot be quantified at this stage.

Reduced inventory

The pilot cell has resulted in a major work-in-progress reduction within its limited area, in proportion to the reduced throughput time (Table VI). Since the pilot cell throughput time is on average

less than half than that for other parts in the plant, a corresponding reduction of over 50% of work-in-progress levels can be expected.

Finished part stocks may not be reduced significantly below current levels, but the current overdue position and stock build-up in an economic boom should be reduced with capacity matched programmes and reliable parts delivery.

A better ability to meet peak demand by reducing order cancellations due to long lead times beyond the demand peak may significantly increase sales revenue without corresponding inventory increase.

9.5.2 OTHER CRITERIA OF JUDGEMENT

Johnson, Newell and Vergin (2) list as the characteristics of effective systems:-

- simplicity
- flexibility
- reliability
- economy
- acceptability

The production mode and associated administrative principles proposed, clearly satisfies these demands. Flexibility may be questioned but within the constraints of the plant concerned, with stable product mix and long life products, it is the flexibility to unforeseen demand level changes, which are most important. These are well catered for within the shortened reaction time of the plant.

Wild (125) discusses the objectives of job structuring, listing "desirable" job characteristics, largely related to behavioural aspects

of work. The production mode discussed here would stand up well against Wild's criteria. The tasks include auxiliary and preparatory work through the informal nature of the worker assignment. Such aspects as inspection, setting, progressing, etc. are added to operator work as job enrichment elements. Cell members perform complete work modules and have a clear relationship to the task of their group, contributing to the overall programme. The group is judged by the product centre output and the operator is closely in touch with his specific production system, the product centre.

Utilising the overlapping group structure for methods analysis, improvements and new work introduction, the requirements for worker participation in methods, work organisation and job design are largely catered for.

The closer relationship between "senior" management (i.e. product manager) and group members gives capable personnel a better opportunity for recognition and advancement.

There has been a deliberate effort to structure the worker assignment in this study, such that job enrichment rather than job enlargement is promoted to a high extent.

Guest and Fatchett (111) list a number of conditions which must apply for successful participative group working:-

- "i) the group or individual must be capable of becoming psychologically involved in the relevant activities
- ii) the group or individual must favour the outcome of the activity
- iii) each individual must see the relevance of the activity to himself.
- iv) the group or individual must be capable of self-expression to

their own satisfaction

- v) there must be enough time to take decisions
- vi) the approach adopted must be economically sound
- vii) there should be no threat of any sort to anyone's feeling of security
- viii) the stability of the management-subordinate relationship must be maintained
- ix) there must be adequate channels of communication
- x) the participants must be aware of the function and purpose of the enterprise."

Whilst the proposed production mode does not conflict with any of these requirements, and generally sets the correct environment for their achievement, the need for management to "make it happen" is clear. No production mode design can intrinsically furnish the above conditions, it can only ensure that the conditions are right for management to develop a participative operating style.

It is interesting to note Schumacher's (126) five principles towards large-organisation theory,

- 1) the principle of subsidiary function
- 2) the principle of vindication
- 3) the principle of identification
- 4) the principle of motivation
- 5) the principle of middle axiom

The proposed production mode largely supports the above theory which is claimed to help to cope with the unsolved problems of the large sized industrial organisation.

9.6 THE ADMINISTRATIVE SUB-SYSTEM

The need for simplicity and achievable setting were discussed above. The administrative procedures proposed rely on the following basic principles

- i) manufacture to programme, where the programme (Master Schedule) matches the customer demand to available capacity and represents an achievable task for the plant
- ii) allocate customer orders to programme and refuse order acceptance where it cannot be covered within the delivery time demanded
- iii) use a hierarchy of supply with clearly defined customer-supplier relationships
- iv) use manageable production modules to perform predetermined tasks, and use higher activity levels as co-ordinating functions only

Items (i) and (ii) should be obvious, but it is remarkable that the literature generally pays little regard to the question of matching capacity to demand. Pullen (110) found in his survey of cellular manufacture, that companies usually had a poor appreciation of their relationship between resources and work load. In the ABC Company, there was similarly a lack of short term resource/load match. In a low inventory environment such a mismatch can be traumatic, causing frequent work starvation. In order to make the proposed production mode workable, the capacity/load match is a fundamental pre-requisite to operational efficiency.

The capacity planning process is, of course, simple in a product based cellular manufacturing system, and the study describes economical procedures to achieve an adequate measure of control.

There has generally been no attempt to apply complex algorithms to optimise the cost function. Costs have not been ignored, of course, but a more balanced view has been taken. A typical example is cited. The mobile valve study (Appendix III) shows how the E.B.Q. concept was utilised to determine a simple order cycling arrangement with balanced lead times and simplicity of order pattern with economic costs. The cyclical ordering pattern proposed for parts manufacture will only minimise costs under exceptional circumstances. It will, however, provide a balanced load and simple, repeating order pattern.

Mather's principle (127) was generally applied to the proposed control systems, i.e. the overall departmental material flow to support the master schedule is closely monitored, but little co-ordinating effort is expended to control individual items through their process. The federal organisation makes this principle particularly applicable, of course, enabling the co-ordination function to concentrate on the balancing of resources and setting objectives.

The procedures discussed use some novel techniques which are peculiar to the production mode for the ABC Company.

A two-stage stock status file, one for parts ordering against programme and a second one for parts allocation against projected stock level is used to deal with the problem of programme and order intake mis-match, which must be discovered and dealt with within safety stock limitations.

The use of a period machining programme (P.M.P.) has been recommended to give each machining centre a clear programme to work to, matched against resource availability.

A simple capacity control mechanism is used in conjunction with

a programme backlog control system to provide management data for necessary programme modifications. The latter is particularly useful to allow management to judge the parallel activity synchronisation of all machining centre relative to the planned assembly programme.

The "cycle data file" provides a simple but effective computer technique to draw up machining programmes which give an ordered cyclical pattern, within most of the low inventory benefits of a conventional saw-tooth inventory profile.

In general, the approach has been to use computer assistance for all routine activities, but allow judgement, based on computer report information to deal with remedial action where required. The combination of simplicity, avoidance of manual routine calculations and job enlargement for individual control staff, should significantly improve the control quality.

The administrative philosophy of "plan the work" and "work the plan" has been applied with the basic principles

- prepare a plan
- ensure the plan can be met
- allocate customer orders to plan
- produce goods to plan
- modify the plan as required

9.7 SOME OBSERVATIONS ON THE PROJECT WORK

To review the work presented in this study, one should remember Martino's (128) observation relative to his own manufacturing systems project that,

"not one single element ... is new, they have all been known for a long time. What is new, is the manner in which they were put together to produce a significantly new concept."

Whilst some novel techniques have been applied, no claim of originality can be made for any one individual systems element. As a total system, however, the solution is claimed to be original in its combination of known systems elements to form one overall optimum systems design.

The project supporting this thesis covered various aspects:

- a) it was decided to test the applicability of G.T. using a pilot cell (Appendix II)
- b) the success of the pilot cell was anticipated by the parallel development of the production mode (the main text of this thesis). Towards the end of 1976, when beneficial results of the pilot cell became apparent, two further projects were started, namely
- c) the total plant layout was prepared within the context of the production mode, developing a product centre based arrangement (Figure 39), and
- d) the first product centre was developed for implementation (Appendix III)

The progress was relatively slow and, once again, it was confirmed that this kind of project requires significant resources and full management commitment. Such commitment is usually difficult to obtain and the project time scale tends to suffer.

The problem was aggravated by the need for attitude changes amongst

managers and workers alike. The project was developed for two plants in parallel. In one of these plants the project was strongly supported by the local site director. Commitment amongst middle managers was, therefore, generally fair. In the other plant, the site director gave an outward attitude of scepticism, and the project found poor acceptance amongst his senior people.

The change in attitudes takes time of course. A talk at the ABC Company by a well-known industrial sociologist resulted in a reaction amongst attendees, ranging from "rubbish" to "best talk I ever heard". The former comment, predictably, came from theory X orientated managers and the latter from more liberal ones. On the other hand, it is interesting to note that one of the most sceptical managers, after eighteen months of project involvement started to lecture to the managers of the unreceptive plant on the need for group working and improved communication. Conceivably a sustained effort could, in time, lead to a wide-ranging change in attitudes amongst company personnel at all levels.

The existing product structure in the Company made the production mode proposed particularly useful. There are, however, certain aspects of the mode which have a more generalised application.

Particularly the concepts of federal decentralisation and participative organisation can be widely applied. It is likely that many companies cannot split their organisation into product centres, but a split into machining centres is often possible. The product centre concept is useful, however, as a means of splitting a large plant into smaller largely independent units, and is a means of improving manageability. A previous study by the author (79) did

show, that for a multi-product plant needing common facilities for all products, the split into machining and assembly centres respectively can be beneficial. Often it may be possible in a plant of that nature to build product centres around major sub-assemblies, supplying a final assembly shop. The latter approach is currently developed within another plant of the Company where the author was involved in guiding manufacturing systems design effort.

The delegation of all production control aspects to the work centres can be generally applied in a cellular production plant. The concepts of capacity-matched programmes similarly have general application. The backlog controls and loading system described are suitable for a cellular manufacturing system but would not suit a functional layout. If the discussion leading to the specification of the production mode is accepted, the functional layout shop is likely to be a poor alternative in any case, only acceptable in those circumstances where a cellular layout cannot be applied for specific reasons.

It is interesting to note that major weaknesses existed in the ABC Company's manufacturing system which had not been appreciated by company personnel. The internal amplification of market demand was one such problem, which had not been recognised as an internal problem. The need for short lead times was recognised in principle, but not its significance. More work outside the manufacturing system is required to deal with this problem and cut the administrative delays between customer demand and manufacturing response.

The problems of unbalanced shop loading, lack of short term capacity balancing and poor assembly/dest linking caused bottleneck

conditions and poor machine shop delivery. A first-principles analysis highlighted these problems and allowed the design of administrative systems to overcome them.

10. CONCLUSIONS

The study presented here demonstrates a "first principles" manufacturing systems design to suit the specific problems of the Company concerned.

Whilst the need for an objective view has been stressed, there appear to be some general principles of manufacturing systems design which can be applied.

As such, the conclusions below have been divided into general and specific sections respectively.

10.1 GENERAL CONCLUSIONS ON MANUFACTURING SYSTEMS DESIGN

- 10.1.1 There is a need for the proper recognition and integration of all systems elements in a business systems design.
- 10.1.2 The interface requirements of systems elements require particular attention in systems design.
- 10.1.3 The "new" approach to manufacturing systems design builds up the systems requirements from a critical analysis of product, market, technology, policies, constraints, strengths and weaknesses.
- A "production mode" can be developed from these inputs, specifying the overall parameters of the required system.
- 10.1.4 The "production mode" may be regarded as the policy/strategy statement on the basis of which detailed plans are developed and implemented by functional specialists.
- 10.1.5 The objective development of a production mode helps to avoid the pitfall of squeezing a systems design into a "standard"

mould such as G.T., functional layout, etc.

10.1.6 Mathematical optimisation of a manufacturing system is an unrealistic objective in real life situations. Quantitative objectives must be balanced against qualitative ones.

10.1.7 Order lead time is a greatly neglected business cost factor, which, whilst difficult to quantify, can dramatically affect company performance, notably customer demand satisfaction and asset management.

10.1.8 A business operating in a cyclical economic environment must attempt to minimise demand change amplification, or even attenuate such changes by suitable cyclical inventory management.

10.2 MOTIVATIONAL ASPECTS

10.2.1 The advent of the socio-technical revolution demands a recognition of human needs in business systems design, based on today's motivational needs of employees.

10.2.2 Today's emerging motivational needs of employees, conflict at times with current attitudes. A production mode must bridge the gap from the autocratic/paternalistic to the participative organisation.

10.2.3 The production mode proposed, provides the correct environment to develop a participative organisation.

10.2.4 The production mode must provide the opportunity for job

enrichment, not only job enlargement.

- 10.2.5 Motivation is often the simplest and cheapest aid to increased productivity.

10.3 SOME GENERAL PRINCIPLES OF MANUFACTURING SYSTEMS DESIGN

- 10.3.1 The organisation should be split into a federation of sub-systems which should form a hierarchical task group structure.

At each level, the split can be either

- vertical by product
- horizontal by function

Vertical division is always preferred. Where constraints make a vertical split impossible, the concept of conflict resolution should be applied to the functional split.

- 10.3.2 The structure should ultimately reduce to task-orientated primary psychological groups, jointly supporting the plant output programme, and assisted by non-executive staff groups.

- 10.3.3 The federal organisation structure is preferred to a functional organisation.

- 10.3.4 A multi-level overlapping group structure will help to provide an organisation focussed on overall company objectives.

- 10.3.5 Groups should be defined to minimise sub-systems linkages, i.e. minimise the need for intra-group co-ordination.

- 10.3.6 Co-ordination should be handled by integrating committees with representatives from associated groups. Functional

co-ordinating departments without operational responsibility are not recommended.

- 10.3.7 The line manager as group leader should take full responsibility for his group's performance. Supporting staff groups are to act as service functions only.
- 10.3.8 Operational decision-making should be delegated to the operating level concerned.
- 10.3.9 Group tasks must be simply defined in output related tasks.
- 10.3.10 The operating environment and task allocation must be simple enough to enable each operating group to understand and control their objective performance.
- 10.3.11 Short lead times are required in the business system, to be able to react quickly to market demand changes.
- 10.3.12 The federal organisation with delegated decision making can significantly reduce administrative lead times.
- 10.3.13 In a cellular environment all progress and quantity control can be delegated to cell personnel, eliminating the need for expensive works order control and scheduling systems.
- 10.3.14 A cellular manufacturing system for complex components will perform best with
- floating labour
 - informal progress
 - conveyor-controlled work flow

Cellular layout without these parameters will be less successful in terms of delivery performance and throughput time.

- 10.3.15 In a low-inventory manufacturing system the assigned tasks for production cells must be matched to available capacity. Tasks must be achievable to be accepted as realistic goals.
- 10.3.16 A capacity-balanced manufacturing programme allows a confident customer order acceptance to planned material availability and thus promotes company delivery credibility.
- 10.3.17 Technological scheduling will significantly reduce set up times.
- 10.3.18 Throughout all hierarchical levels, performance control should be based on
- delivery performance
 - return on assets
- Group profit and loss accounting should be used to allow groups to judge their performance. Emphasis should be on the profit/asset ratio, with little emphasis on each sub-optimal aspects, eg. machine utilisation and direct operator efficiency.

10.4 GENERAL CONCLUSIONS ON THE PROJECT WORK

- 10.4.1 Production systems changes need adequate resource allocation to enable significant changes to be made. Low top management commitment and poor resource availability are the greatest

dangers to project success.

- 10.4.2 Attitudes amongst senior and middle management have a significant effect on manufacturing systems changes.
- 10.4.3 Some of the technological arguments put forward by researchers such as inflexibility and poor machine utilisation have, relative to human systems requirements, become largely irrelevant.
- 10.4.4 The advantages of increased personnel effectiveness cannot be clearly anticipated. Thus anticipatory comparison calculations of costs and savings of different systems configurations become largely futile.
- 10.4.5 Non-predictable benefits such as increased sales revenue due to better response to demand changes and increased productivity due to motivational changes may be so large as to overshadow most other cost factors in comparative systems review.

11. FUTURE WORK

The work presented in the previous chapters illustrates a broadly based approach to first principles manufacturing systems design. To be able to give a reasonably comprehensive analysis, it was necessary to gloss over a number of specific areas.

The manufacturing system designed for the ABC Company is based on a number of assumptions, some of which require more detailed study to prove their general validity. The resources made available up to the current time have not allowed all areas to be studied in detail, and further research is required.

The question of lead time as a factor of demand amplification and the cost of lead time was discussed. Further theoretical analysis is required to assess these commonly ignored elements of business systems performance. Systems modelling perhaps, expanding Forrester's (16) work, or using a proprietary simulation language, may help in this respect. Care has to be taken, however, to build a model which does not over-simplify the business environment.

The question of manageability as a major design factor was discussed in general terms. Whilst this is a particularly difficult systems variable, G.T. projects in the field seem to indicate that manageability relative to operational unit size and complexity is a vital aspect. An attempt must be made to quantify it, to enable organisation theory to cope with this aspect.

The work presented basic organisation structure design parameters, based on conflict resolution and federal structure respectively. The principles and relative problems of these concepts should be studied, to determine their role in modern plant organisation theory. Certain

sociological and psychological elements were considered in the design of the specific ABC Company production mode, but a more general analysis is required, with in-depth study of motivational and sociological aspects. The practical limitations of a group organisation structure, and in particular, Bowey and Connolly's orbital management structure require further research. In general, the effect of the democratic way of life on the human demands from the business organisation should be considered.

A significant discussion of the motivational impact on productivity was presented. The claim of possible significant productivity improvements with improved mental health calls for a detailed study of the relevant subjects. The work should also address itself in a practical manner, to the need of providing such enhanced motivation and suitable training, particularly for supervisors, to provide an environment in which these motivational aids can come to flourish. The real cost of monotony would, of course, be a particular area for suitable study, leading logically to an analysis of the possible improvement of the working environment by the suitable application of automation for routine tasks.

Two areas are currently considered by ABC Company staff, which have a particular bearing on the proposed production mode, namely

- a) incentive systems, and
- b) work centre performance monitoring

It is clear that the proposed system has no place for individual incentive schemes. Any scheme must reward a group. All employees must benefit from an incentive system, which does not materially affect regular earnings and thus instill a fear element. Profit

sharing systems seem most promising but detailed study is required. If the incentive scheme is linked to work centre performance, a company - objective - based performance control is required, which specifically measures

- cost
- quality
- delivery performance

Arn (29) has given an indication of the type of approach which can be considered, but further work is required for a comprehensive plant-wide system.

The study indicated above is linked to the need for further work to plan the method in which the current socio-technical revolution can be practically dealt with. Whilst the systems design aspects were discussed in some depth, management style and training requirements belong to a separate analysis. There would appear to be a call for a multi-disciplinary study linking aspects of sociology, industrial psychology, organisation theory and manufacturing technology to deal with these problems.

In the thesis, the author clearly had difficulties defining the overall scope of manufacturing systems design. It was claimed that a broad analysis of external constraints, objectives, market demands and internal strengths and weaknesses, is required to define the parameters for the production mode. Whilst a reasonable survey was undertaken, it was, due to lack of resources, superficial in some areas. There is a need to look in more detail at this work under the general heading of business planning. In particular the interface requirements and the effect of long term strategies need

to be considered more fully in comprehensive manufacturing systems design. Such work belongs into the business schools and generally stretches beyond the scope of a production study.

The methodology for the current-state-analysis warrants further work. For example, survey forms can be designed and Dale's (108) work could be used as a lead to develop a generalised manufacturing systems profile, from which specific requirements can be more clearly identified.

As such, a general methodology for the production mode specification, systems design and project control would be a most useful contribution.

More specifically, the production mode for the ABC Company pinpointed a number of areas for more detailed study.

The cost of fixed and current assets and their relative trade-off appears to be important, when considering the requirements for machine utilisation and stock levels. As indicated in the analysis, the two are interdependent, and further study is required to solve the popular discussion for and against machine under-utilisation in small work centres.

The variability of direct labour cost as a major decision factor was questioned, and particularly in the current industrial climate, a detailed study is warranted to dispell the apparent myth of regarding direct labour as a variable cost.

In order to reduce the need for routine administrative duties, there seems to be a requirement for the design of computer-based systems for order cycle calculation, capacity analysis and works order control. Some flow charts have been presented, but more

extensive and sophisticated systems for decentralised cellular production should be developed. In particular, computer systems should be designed to provide meaningful information to support the informal production control required in group working based on delegated decision making.

APPENDIX IECONOMIC BATCH QUANTITY THEORYE.B.Q. Formula

Annual cost = stock holding cost + ordering cost + parts cost

Stock holding cost = $\frac{1}{2} \times I \times Q \times C$

Ordering cost = $\frac{A}{Q} (S \times R + F)$

Parts cost = $A \times C$

where I = interest rate

Q = batch quantity

C = parts cost

A = annual parts usage

S = setting time

R = variable hourly rate of setting up

F = fixed order cost

The economic batch quantity is given by

$$Q_E = \sqrt{\frac{2 A (S \times R + F)}{I C}}$$

Production costs

Let annual stock holding cost = C_s

ordering cost = C_o

parts cost = C_p

annual total cost = C_t

$$\text{then } C_t = C_s + C_o + C_p$$

For economic batch quantity

$$\begin{aligned} \text{let stock holding cost} &= E_s \\ \text{ordering cost} &= E_o \\ \text{parts cost} &= E_p \\ \text{total cost} &= E_t \end{aligned}$$

It can be shown that,

$$\begin{aligned} E_s &= E_o \\ \text{and } E_p &= C_p \end{aligned}$$

$$\text{therefore, } E_t = C_p + 2 E_s = C_p + 2 E_o$$

Assume that batch sizes are to be selected for a maximum cost penalty Δ of the total cost E_t , such that at the cost limit,

$$C_t \text{ max} = E_t (1 + \Delta)$$

$$\text{then } C_s + C_o + C_p = E_t (1 + \Delta) = (C_p + 2 E_s) (1 + \Delta)$$

$$(C_s + C_o) = \Delta C_p + 2 E_s (1 + \Delta)$$

Thus an ordering cycle can be chosen such that $(C_s + C_o)$ does not exceed $(\Delta C_p + 2 E_s (1 + \Delta))$

From above

$$\begin{aligned} C_t &= C_s + C_o + C_p \\ &= \frac{1}{2} I Q C + \frac{A}{Q} (S R + F) + A C \end{aligned}$$

for a regular number of orders per year ($N = \frac{A}{Q}$),

$$C_t = \frac{\frac{1}{2} I C A}{N} + N (S R + F) + A C \quad (i)$$

for the specified cost penalty Δ ,

$$C_t = (C_p + 2 E_s) (1 + \Delta) \quad (ii)$$

$$E_s \text{ occurs when } Q = \sqrt{\frac{2A (S R + F)}{I C}} = Q_e$$

$$C_p = A C$$

$$E_s = \frac{1}{2} I Q_e C$$

Thus from (ii)

$$C_t = (A C + I C Q_e) (1 + \Delta)$$

and equating with (i)

$$(A C + I C Q_e) (1 + \Delta) = \frac{\frac{1}{2} I C A}{N} + N (S R + F) + A C$$

$$\frac{1}{N} (\frac{1}{2} I C A) + N (S R + F) + (A C - (A C + I C Q_e) (1 + \Delta)) = 0$$

$$N^2 (S R + F) - N (\Delta A C + I C Q_e (1 + \Delta)) + \frac{1}{2} I C A = 0$$

$$N^2 - N \left(\frac{I C Q_e (1 + \Delta) + \Delta A C}{S R + F} \right) + \frac{I C A}{2(S R + F)} = 0$$

$$\text{let } b = \frac{((I C Q_e (1 + \Delta) + \Delta A C))}{S R + F}$$

$$d = \frac{I C A}{2(S R + F)}$$

$$N = \frac{b}{2} + \sqrt{\frac{b^2}{4} - d}$$

Thus if a pre-determined cycling arrangement is chosen, say 3, 6 or 12 cycles per year, N can be calculated, and the nearest higher standard cycle can be selected.

"d" is, of course, a measure of the cost sensitivity of the plant concerned.

Alternatively, the cost penalty Δ for any one cycle frequency N can be calculated as follows:-

$$N^2 (S R + F) - N(\Delta A C + I C Q_e (1 + \Delta)) + \frac{1}{2} I C A = 0$$

$$\Delta = \frac{N(S R + F) - I C Q_e + \frac{I C A}{2N}}{A C + I C Q_e}$$

Work-in-progress influence

Total cost = $C_s + C_o + C_p$ + stock holding cost for work-in-progress

let C_w = work in progress cost

M = material cost

L = labour plus overhead cost

t = batch throughput time (years)

$$\text{Average parts value in progress} = M + \frac{(S R + F)}{2Q} + \frac{L}{2}$$

$$\text{Stock holding cost} = t \quad I \quad A \left(M + \frac{(S R + F)}{2Q} + \frac{L}{2} \right)$$

$$\text{Total Cost} = \frac{I Q C}{2} + \frac{A}{Q} (S R + F) + A C + t I A \left(M + \frac{L}{2} + \frac{S R + F}{2Q} \right)$$

for minimum cost

$$\frac{d C_t}{d Q} = 0 = \frac{I C}{2} - \frac{A(S R + F)}{Q^2} - t I A \left(\frac{S R + F}{2Q^2} \right)$$

$$\text{thus } Q = \sqrt{\frac{2A(S R + F) \left(1 + t \frac{I}{2} \right)}{I C}}$$

since in a high flow manufacturing system t is small, the term $t I$ can normally be ignored.

The effect of setting time

$$\text{Total component cost} = M + L + \frac{S R + F}{Q}$$

$$\begin{aligned} C_t &= \frac{I Q C}{2} + \frac{A}{Q} (S R + F) + A C \\ &= \frac{I Q}{2} \left(M + L + \frac{S R + F}{Q} \right) + \frac{A}{Q} (S R + F) + A C \end{aligned}$$

$$\text{thus } Q_e = \sqrt{\frac{2 A (S R + F)}{I (M + L)}} = \sqrt{\frac{2 A (S R + F)}{I C}}$$

The component cost C in the equation is, therefore, exclusive of set-up cost. Where standard costs involve a set-up allowance, the

component cost "C" is the standard cost less the setting allowance.

APPENDIX IITHE PILOT CELL

It has been claimed by successful users, that Group Technology (G.T.) will only offer full benefits if it is treated as a company-wide operating philosophy. At the same time it is a fact that company-wide adoption of G.T. is the exception rather than the rule (110).

The example of Serck Audco in particular has demonstrated clearly, how a company can benefit by firstly linking the manufacturing aspects of

plant layout

industrial engineering

production planning and control

and also incorporate engineering and marketing considerations into an integrated business systems flow.

There is no doubt a problem in defining the boundaries of the systems design and if a company is too ambitious, the project may be doomed before it starts, especially if there is no clearly defined project plan and continuous top management support over what will no doubt be a major programme, extending over a number of years. Many companies appear to be content with a general machine shop re-arrangement and are surprised if the benefits, though perhaps tangible, fall short of expectations.

A decision was taken about two years ago by the ABC Company to utilise G.T. principles of operation on a worldwide basis and key objectives were set to

- improve delivery performance
- improve quality of life for employees
- improve asset management
- ensure a greater utilisation of human skills amongst company staff at all levels of the organisation

Around 1968, however, the Company had already laid out its machine shop in a cellular pattern, with thirteen largely autonomous machining cells, each one responsible for the production of a clearly defined component family.

The G.T. layout was developed by the Industrial Engineering Department who recognised that the Company's products fall into a small number of component families, each one consisting of a range of parts of close geometric similarity.

The work had been covered within the rules of good layout methodology, and no G.T. label was attached to the project at the time. Thus, no conscious liaison had taken place with other functional departments, to develop an integrated manufacturing system. Within the material flow system, the work was highly successful, and significant benefits were achieved in terms of batch throughput time, work in progress and finished parts inventory, making performance in those areas superior to other plants within the Corporation. A cost penalty of reduced average machine utilisation has been accepted. The principle of "floating labour" has been adopted, employing machine operators as general machinists who move between different machines as dictated by the dynamic load situation in each machining cell.

The results were not, however, as spectacular as those quoted by some of the more successful G.T. users, and it was felt that further

benefits could be achieved by developing G.T. concepts in the areas of improved material flow control, integrated systems development, and greater delegation of decision making to lower operating levels.

It was thus decided, to test some of these aspects in the limited area of pilot cell to predict the extent to which further improvements could be obtainable.

It was appreciated that a pilot cell could only give indicators, and that for example, control systems changes can only be tested to a limited extent in a single cell without co-ordination of material flow across the shop as a whole. It was felt, however, that the pilot exercise would be a useful learning vehicle to discover to what extent the existing G.T. shop could be improved.

A family of components was chosen for the pilot cell consisting of around 30 different but similar complex component types requiring on average 15 machining operations. The manufacture of this family had been fragmented across the shop to a significant degree, even though a "core" cell for the major operations existed already. Since the manufacturing performance for these parts was relatively low, it was hoped to draw interesting conclusions after pilot cell implementation, firstly, compared to its pre-G.T. performance and, secondly, to performance of other already more homogenous machining cells.

The pilot cell consists of 22 machines with 10 operators per shift, using conveyors to control the flow paths.

Figure 56 shows the schematic layout and Figures 57 and 58 are photographs of the completed cell.

In general terms, significant improvements were achieved in the

pilot cell, relative to pre-G.T. performance and overall plant performance respectively. These improvements covered specifically:

- work in progress reduction
- batch throughput time reduction
- predictable delivery performance to plan
- high operator morale
- methods improvements
- set-up time reduction

Batch throughput time reduction and predictable delivery performance were the most significant improvements. Cell components had previously had an average batch throughput time of 12 weeks, with a range of 8 to 24 weeks, relative to a planned lead time of 12 weeks. The pilot cell reduced the average batch throughput time to 3 weeks, with a range of 1 to 5 weeks.

The throughput time achieved compared with 5 to 8 weeks as typical values for existing cells in the plant with "good" flow patterns. The reduction was achieved by:

- the use of roller conveyors to act as a bottleneck indicator, speeding material transfer
- low transfer quantities between machines by splitting batches over a number of small boxes
- delegation of all progress activities to pilot cell personnel for quick on-the-spot decision making

Cell scheduling was limited to the issue of work with pre-determined batch sequencing lists, leaving detailed scheduling to pilot cell members.

Operator morale was high in the pilot cell. Whilst this is

probably to some degree due to a "Hawthorne" effect, there is no doubt that operators appreciated the increased communication and responsibility and there seemed to be a basis for higher job satisfaction in the production mode applied.

As an incidental saving, a systematic analysis of all components in the parts family, requiring to achieve methods commonality for unidirectional work flow, led to the elimination of unnecessary operations performed on some parts but not on others. Two hundred and fifty direct labour hours per month were saved from this analysis alone, and further savings are expected when engineering changes to standardise casting allowances and machining tolerances have been fully implemented.

Set-up time reductions were achieved by scheduling parts in such a sequence, that change-over times between parts were reduced. To quote an example, the pilot cell used multi-spindle drills with an allowed set-up time of 8 hours per batch, assuming random loading of batches. By grouping all cell components into 8 groups, set-up times could be maintained at 8 hours for the first part in each group and reduced to 5 hours for subsequent parts. A total saving of around 50 set-up hours per month was achieved on these machines at no cost whatsoever. Further savings can be achieved by industrial engineering effort, developing group tooling and pre-setting techniques.

For about three months, efficiency suffered badly, and there is no doubt that a proportion of the work in progress saving was "thrown away" in operator waiting times. The loss of efficiency was temporary, however, and was fully recovered after three months. Whilst the fluctuation of monthly figures makes detailed analysis difficult,

there would appear to be evidence that labour efficiency has improved in the order of 5 - 10% over and above savings due to improved methods and reduced setting time.

The efficiency loss was a combination of several problems, namely,

- capacity mismatch during throughput time reduction
- operator training to expand the concept of floating labour and training some operators in the use of machines with which they were unfamiliar.
- phase-in problems, where some part-finished batches of pre-G.T. method disrupted the work flow

One should be aware, when assessing the potential savings of G.T., that some degree of disruption will certainly occur and some of the inventory reduction achieved will be transferred from inventory to expenses and will not generate a positive cash flow.

Table VI shows the results achieved by the pilot cell for some of the major savings.

APPENDIX IIITHE PILOT PRODUCT CENTRE

At the time of writing the ABC Company had completed a study for the implementation of a directional valve product centre, based on a specific family of units.

The product centre was chosen for the first fully integrated semi-autonomous centre, totally responsible for the production of these valves, including

- body machining
- spool machining
- assembly
- test

It has its own management structure, and included the following activities:

- production planning and control
- dedicated tool storage and control
- finished part storage

The basic flow pattern is as per Figure 59, which formed the layout block diagram.

Basic product centre parameters are :

Two significant parts:

Bodies: 9 significant items
 generally 12 batches/year
 40,000 parts per year

Spools: 10 significant items
 generally 6 or 12 batches/year
 45,000 parts per year

Spool sizes are matched to body bores. Generally, any spool type can be matched to any body type.

There are some ancillary parts supplied either as purchased items or sub-contracted to a miscellaneous parts product centre.

MATERIAL FLOW PATTERN

The product centre was divided into three work centres.

- body machining centre - 10 operators
- spool machining centre - 8 operators
- assembly and test centre - 10 operators

A nominal buffer of parts was planned to be held between machining and assembly to balance any delivery fluctuations. Parts should be selected in assembly kit form and passed into the assembly area, for assembly and test.

Figure 60 shows the detailed product centre layout.

ADMINISTRATIVE SYSTEMS

Current systems interfacing

It was planned that the product centre would be implemented before G.T. - type computer systems had been introduced. The centre would thus need to be run in conjunction with existing systems, utilising manual procedures where required.

Master Schedule

It was known that the product centre had ample machine capacity to cover all foreseeable short-term requirements. Thus the short-term machine capacity planning was ignored.

Labour capacity planning is to be dealt with simply by:-

- a) calculating the average number of operators required to satisfy the long term forecast
- b) monitoring the backlog progression and adding or subtracting labour by transfer if required

The capacity matching is to be based on body and spool machining respectively. It was assumed that a constant ratio between machining and assembly/test work centres existed.

Controls are to be by manual judgement, comparing demand with resources.

Firm Distribution Centre orders are received by Manufacturing, covering three months' firm orders. This simple concept assists in the manual operation of the centre.

A monthly D.C. order book can be manually converted into a body load, which is valued in terms of standard hours and matched against planned labour availability. A Period Machining Programme (P.M.P.) can be prepared for this purpose, based on gross body requirements. Any over or underload should be re-negotiated with the D.C.

A year-to-date accumulative total of body orders would be maintained, comparing a forecast to actual D.C.orders.

The D.C. orders are to be entered into the stock status file in the usual manner, so that the centre planner can use the stock status

master schedule as a basis for his calculations. Any negotiated changes can then be introduced as a subsequent order changes.

Each D.C. order book should be split into four equal weekly programmes to simulate linear parts usage.

Order cycle analysis - Bodies

An analysis of parts cycling (Table VIIIa) showed that the number of cycles per year using E.B.Q. theory varies widely, from 3.6 to 8.7, with a piece count weighted mean of 6.7.

It was felt, that short order cycles must be used for rapid response, and it was believed that an "orderly" shop, with a simple ordering pattern and short cycles with closely linked assembly scheduling, would yield overall cost benefits. These benefits were hard to quantify, and an arbitrary decision was made to test the effect of a 5% maximum cost penalty over and above E.B.Q. - based component cost.

Table VII (a) shows maximum and minimum cycle lengths with the 5% penalty. On the basis of that analysis, a two-week cycle (i.e. 24 per year) was selected for all but one part. The analysis illustrated that in general a short, single phase, single cycle ordering system could be used within acceptable cost penalty. In fact Table VII (a) shows that the average cost penalty is only 3.0% of total annual variable cost.

Order cycle analysis - Spools

Table VII (b) shows a similar analysis for spools. The mix variation was higher than for bodies and again an order distribution

was chosen, taking generally account of the 5% cost penalty, and planning for a regular cyclical pattern of varying in-phase frequency.

Table VII (b) shows, that the cost penalty is slightly higher than for bodies at 3.7% of total cost.

Cycle Data

With a three months lead time for firm orders, machining and assembly to firm order was feasible. Delivery delay safety stocks are required since the time scale does not permit a time buffer between machining and assembly.

A procedure, based on a cycle calendar is suggested, based on order periods where each period is of half a month's length, balancing period start dates to give approximately ten working days per period. (Figure 61).

The cycle calendar is marked "X" against each period, when a batch of the parts concerned is to be received in store (i.e. in store on the first day of the period concerned for assembly availability).

The "P.M.P start" row indicates when the batch parts marked "X" are to be included into a P.M.P. to take account of the lead time of manufacture.

Thus on Figure 61, part number 1234 has an "X" shown against period 4, with a "4" marked against period 2. The "X" against period 4 indicates that a batch of parts is to be planned for receipt at the beginning of period 4, covering net requirements for period 4 plus subsequent periods up to but not including the next period marked "X".

The "4" against period 2 indicates that in the P.M.P. for period 2 the net requirements previously calculated (period 4 and onwards)

are to be included as a batch quantity.

The "X" matrix is drawn up to give a reasonable load spread across all periods to approximately balance the work centre load.

The corresponding "P.M.P. start" period is calculated, with due regard to the machining lead time as

$$\text{Machining lead time (periods)} = \text{Batch throughput time} + \text{P.M.P. cycle time} - 1 \text{ (periods)}$$

i.e. if Batch throughput time is two weeks (1 period) and the P.M.P. covers a months requirements (2 periods) then the machining lead time is $(1 + 2 - 1) = 2$ periods.

If the part is marked "X" against period 4, the corresponding "4" is marked in the "P.M.P.start" row against period $(4-2) = 2$.

In order to simplify the manual control, common lead time for all bodies (2 weeks) and spools (4 weeks) respectively was assumed.

Net Requirements

The net requirements are calculated to bring the projected bin level in the works order receipt period back to a pre-defined safety stock.

For all parts having 12 or less cycles per year, the required number of months' usage can be summed, by looking at the last month prior to the next "X" on the cycle calendar, and restoring the "B" - line on the stock status print-out back to its safety stock level.

For parts having 24 cycles per year, orders for the first period of each month should be calculated as half net requirements, and orders for the second period are the remaining net requirements.

Since spools may be ordered beyond the forecasting horizon, the

centre planner would need to enter manually requirements into his stock status tab run, based on average monthly usage, to calculate his projected usage rate.

Safety stock

The existing system of monthly requirements planning in the ABC Company did not allow for the implementation of the theory of approximating a saw-tooth form of inventory movement. Each P.M.P. (period machining programme) would need to be phased such that all requirements on the P.M.P. would be in store prior to the usage period. Thus early batches would be stocked prior to demand, and result in a stock penalty.

To overcome the problem, safety stocks can be adjusted to take account of the safety inherent in early delivery. Since manufacture is to firm order, no mix change stocks are required.

Nominal safety stock calculations can be made as follows:-

Scrap and loss	10% of average batch quantity (i.e. annual demand ÷ number of cycles x 0.1)
Delivery variation	2 weeks normal usage

Since the programme plans for all required parts to be available at the start of each assembly period, some parts will have to be produced prior to the requirements date, and thus some safety time is inherently available for planned batches. The normal start days from a period start are taken from a bar chart ("A" days), based on typical quantities and pre-determined loading sequence.

Assuming a fixed batch throughput time of two weeks for bodies, the expected delivery is

A + 10 days

The requirement date for bodies is 4 weeks (20 days) from P.M.P start date. Thus early delivery ("B" weeks) is

$$B = \frac{20 - (A + 10)}{5} = \frac{10 - A}{5} \text{ weeks}$$

Net safety weeks (c) are allowed weeks (2 weeks) less planned early delivery ("B").

Delivery safety stock is, of course, (c) times normal weekly usage, based in the annual demand. The scrap/loss safety stock of 10% batch quantity needs to be added to this figure.

P.M.P. Generation

A P.M.P. is drawn up for net requirements

- a) for bodies on a 2 weekly basis
- b) for spools on a 4 weekly basis

There is no formal adjustment for backlog control in the P.M.P generation, and, as recommended for the computerised systems, the backlog situation would be dealt with by management judgement.

Safety stocks are planned to absorb all availability disturbances, and no allowances are added to the net requirement.

To determine which parts are to be included in the P.M.P., the cycle calendar (Figure 61) is reviewed. If, say, a P.M.P. is to be prepared for periods 1 and 2, the period 1 and period 2 columns are scanned. Any part with a period number against "P.M.P. start" in

these columns is included in the P.M.P.

Backlog Monitoring

At the end of each period, the backlog situation needs to be monitored by comparing planned progress with actual progress.

A simple rule can be applied, calculating the total piece-part weighted number of batches completed as a percentage of the total programme and comparing that figure with planned progress.

An example illustrates the process:-

Part Number	Quantity	Completed
123956	200	Yes
234567	50	Yes
345678	500	Yes
456789	1000	No
Number of parts completed	750	
Number of parts in programme	1750	
% completion	43%	

Assuming the P.M.P. was issued for two periods, with a planned batch throughput time of 2 weeks, then as a rough approximation planned progress can be regarded as:-

Weeks from planned issue date	% planned completion
0	0
1	0
2	0
3	25
4	50

5	75
6	100

Thus, for example, assuming the P.M.P. was issued in period 3, for periods 3 and 4, and the end of period 4 has been reached, the planned completion should be 50% relative to the actual of 43%. Work is thus 7% behind programme, i.e. 7% of two periods (since the P.M.P. covers two periods), or approximately $1\frac{1}{2}$ days.

If more than one P.M.P. is in progress, all P.M.P.'s must be valued, and their sum total backlog calculated.

Works Order Control

The existing open works order file is fully utilised. All batches on a P.M.P. are to be released through the computer, though the works order documentation would be ignored.

Stores receipts, scrap rectification and diversions can be logged in the usual manner, to update the stock status file, closing works order in the usual manner.

Operation-by-operation data need not be fed back and all scheduling documentation would thus become meaningless for this product centre.

A batch should be accompanied by one batch card only, held by the cell supervisor for the duration of the work cycle.

Material issue should be unchanged, but triggered by the cell supervisor, who receives initially the P.M.P. and for each listed batch, a material requisition and a batch card.

When a batch is completed, the batch card should be marked up with the good quantity passed into store, and the card handed to the

centre planner who closes the works order.

Assembly Scheduling

It is expected that the product centre manager will receive a listing of all D.C. orders entered into the open customer order file.

Two weeks prior to the planned assembly week, the centre planner will designate draw-off units manually. Assembly draw-off will take place through the existing computer system, where the assembly programme is passed to data processing, who generate all assembly kit lists and deduct stocks accordingly from availability.

Organisation Structure

Figure 62 shows the proposed organisation structure for the product centre.

In this structure, the Product Centre Manager has full accountability for his output. He is assisted by a Production Planner who is accountable for

- requirements planning
- stock control
- raw material planning
- purchased parts planning
- P.M.P. generation
- works order issue
- assembly draw-off

Two supervisors report to the Product Centre Manager, one responsible for machining, and the other for assembly and test. The latter would also logically be responsible for stores control,

assembly kit preparation and valve body honing.

The setter should be the senior man in each machining centre,
and as such assist his supervisor in the maintenance of good work flow.

- part, component - a piece part which, in conjunction with other parts, is assembled into a sub-assembly or final product
- unit - a uniquely specified final assembly item
- component family - a group of parts combined by virtue of similar geometry, function, process or other criterion
- family group, product family - a group of units having a common family code, and making up a range of units within one model type
- product group - a group of product families of similar types of units
- work centre - a generalised organisation module responsible for execution of specified tasks
- product centre - a work centre responsible for the total manufacture of a product group of units
- machining cell - a work centre responsible for the total manufacture of a family of machined parts; a sub-set of a product centre
- assembly cell - a work centre responsible for the assembly and test of a specified range of unit types; a sub-set of a product centre
- supply - the provisioning of products for shipment to the customer (covered by manufacturing)

- demand - the demand of products from manufacturing for shipment to the customer (covered by marketing)
- supply function - manufacturing
- demand function - marketing
- shortage - part(s) called up for and not available for assembly
- diversion - unplanned loss from or gain to a works order

REFERENCES

1. Drucker, P.F. "The Practice of Management"
Pan Books, 1969
2. Johnson, R.A. "Production and Operations
Hewell, W.T. Management"
Vergin, R.C. Houghton-Mifflin Co. 1974
3. Galbraith, J.K. "The New Industrial State"
Penguin, 1969
4. Flagle, E.D. et al "Operational Research and Systems
Engineering"
John Hopkins Press, 1960
5. Timms, H.L. "The Production Function in Business"
Pohlen, M.F. R.D. Irwin, 1970
6. Johnson, R.A. "The Theory and Management of Systems"
Kast, F.E. McGraw-Hill, 1973
Rosenzweig, J.E.
7. Thornley, R.H. "Group Technology - A Complete
Manufacturing System"
Inaugural Lecture, University of
Aston in Birmingham, 14th October,
1971
8. Ranson, G.M. "Group Technology"
McGraw-Hill, 1972

9. Connolly, R. "The Integration of Group Technology Principles into a Manufacturing System"
Unpublished Ph.D. Thesis,
Victoria University, Manchester,
January, 1969
10. Bryan, D.E. "Group Technology Application in a Small Company"
I. Prod. E. Seminar of G.T.
Specialist Division, Whateley Hall,
Banbury, 28-29th November, 1972
11. Forrester, J.W. "Principles of Systems"
Wright-Allen Press 1971
12. Buffa, E.S. "Modern Production Management"
J. Wiley & Sons, 1973
13. Schoderbek, P.P. "Management Systems"
J. Wiley & Sons, 1971
14. Bedworth, D.D. "Industrial Systems"
Ronald Press, 1973
15. De Greene, K.B. "Sociotechnical Systems"
Prentice-Hall, 1973
16. Forrester, J.N. "Industrial Dynamics"
M.I.T., 1962

17. Roots, W.K. "Industrial Systems Analysis"
The Production Engineer, March, 1967
18. - "UNIS/90 Industrial System"
Sperry Univac Manual U5767
19. - "Communication Oriented Production
Information and Control System"
IBM, 1972
20. Chase, W.P. "Management of Systems Engineering"
John Wiley & Sons, 1974
21. Chestnut, H. "Systems Engineering Methods"
John Wiley & Sons, 1967
22. Connolly, R. "Management Structure for the
Implementation of Group Technology"
Annals of C.I.R.P., Vol. XVIV, 1971
23. Ranson, G.M. "Production Planning and Control"
Toms, B.H. H.M.S.O., 1968
24. Likert, R. "The Human Organisation"
McGraw-Hill, 1967
25. Sloan, A.P. "My Years with General Motors"
Pan Books Limited, 1969
26. Skinner, W. "Manufacturing - Missing Link in
Corporate Strategy"
Harvard Business Review, May/June, 1969

27. Tiefenthal, R. (Ed.) "Production"
McGraw-Hill, 1975
28. Malik, M.Y. "Considerations for the Formation of
Connolly, R. Cells in Group Manufacture"
Sabberwal, A.J.P. Paper given at the 14th International
Machine Tool Design and Research
Conference, Manchester,
12-14th September, 1973
Macmillan Press Limited, 1973
29. Arn, E. "Application of Systems Engineering
to Group Technology"
Unpublished Ph.D. Thesis, The
University of Aston in Birmingham,
March, 1974
30. Bjorke, O. "Cost Evaluation of Design Features
Using Autopress"
Manufacturing Systems No.3, 1974
31. Hosang, S. "Aufbau und Anwendung eines
Formenschlüssels für Konstruktion"
Industrieanzeiger, 7.5. 1963
32. Bries, S. "Praktische Erfahrungen mit einem
Formenschlüssel, für Konstruktion
und Arbeitsvorbereitung"
Industrieanzeiger, 7.5. 1963

33. Maslow, A.H. "Motivation and Personality"
Harper & Row, 1970
34. Herzberg, F. "Work and the Nature of Man"
Staples Press, 1968
35. Miles, R.F. "Systems Concepts"
John Wiley & Sons, 1973
36. Leonard, R. Private Communication
37. Hagan, P.C. "Strategies for Increasing the
Leonard, R. Utilisation and Output of Machine
Tools"
Proceedings of 13th M.T.D.R. Conf.
UMIST, Manchester, September 1973
38. McLain, L. "Stubborn Business Men Ignore
Critical Economic Cycles"
The Engineer, 19/26 December, 1974
39. Samuelson, P.A. "Economics; An Introductory Analysis"
McGraw-Hill, 1967
40. Nicholson, F.A. "Inventory Management"
Internal Sperry Rand Corporation
Lecture Note, issued by Director,
Inventory Control, Sperry Rand Corp.
41. Plossl, G.W. "Production and Inventory Control"
Wight, O.W. Prentice-Hall, 1967

42. - "German Auto Workers Spread Net
Against Recession"
Business Europe, October 22, 1976
43. - "Labor: A Fixed Asset"
Business International, January 30,
1976
44. - "U.S. Labor Sets Ambitious Goals"
Business International, March 25, 1977
45. Hollingham, J. "Cyclic Imbalances in Investment
put Industry on the Rack"
The Engineer, 22/29 August, 1974
46. - "Industrial Democracy Makes Debut
in the U.S., More Inroads in Europe"
Business International, May 28, 1976
47. Woolley, V.S. "Computer Based Production Control
in a Group"
Serck Audco Limited
48. Clarke, R.O. "Workers' Participation in Management
Fatchett, D.J. in Britain"
Roberts, B.C. Heinemann, 1972
49. Forrester, J.W. "Collected Papers of Jay W. Forrester"
Wright-Allen Press, 1975

50. Bowey, A. "Application of the Concept of
Connolly, R. Working in Groups"
Management Decision No.3, 1975
51. Brech, E.F.L. "Organisation"
Longmans, Green & Co. 1958
52. Roethlisberger, F.J. "Management and the Worker"
Dickson, J.W. Harvard University Press, 1949
53. Hill, D. "Organisation, Structure,
Co-ordination and Communication"
The Chartered Mechanical Engineer,
April, 1974
54. Skinner, W. "The Focused Factory"
Harvard Business Review, May-June,
1974
55. Brown, J.A.L. "The Social Psychology of Industry"
Penguin Books Limited, 1954
56. Rice, A.K. "Productivity and Social Organisation"
Tavistock Publications, 1970
57. Schein, E.F. "Organisational Psychology"
Prentice-Hall Inc., 1970
58. Beer, M. "Organisational Size and Job
Satisfaction"
Academy of Management Journal,
March, 1964

59. Revans, R.W. "The Analysis of Industrial Behaviour"
The I. Prod. E. Journal, Vol.36,
July, 1957
60. Lorsch, J.W. "Studies in Organisation Design"
Lawrence, P.R. Irwin Dorsey, 1970
61. Smith, A.M. "Financial Justification"
I. Prod. E., G.T.Specialist Division
2nd Annual Conference, Whately Hall
Banbury, 28-29th November, 1972
62. Woodward, J. (Ed.) "Industrial Organisation: Behaviour
and Control"
Oxford University Press, 1970
63. Miller, E.J. "Systems of Organisation"
Rice, A.K. Tavistock, 1967
64. March, J.G. "Organisations"
Simon, A.A. Carnegie Institute of Technology,
1958
65. Blake, R.R. "The Managerial Grid"
Mouton, J.S. Gulf Publishing Co., 1968
66. Vroom, V.H. (Ed.) "Management and Motivation"
Deci, E.L. (Ed.) Penguin, 1970

67. Gedrich, S.F.
Burnett, J.A.
Holland, J.G.F. "The Impact of Changing Personal Values on Sperry Rand's European Operations"
Sperry Rand Management Communications Conference, 21st-23rd June, 1976
68. - "Happiness is this Shape"
Sunday Times, August, 1, 1976
69. Argyris, C. "Integrating the Individual and the Organisation"
John Wiley & Sons, 1964
70. Herzberg, F. "The Wise Old Turk"
Harvard Business Review,
September/October, 1974
71. Banks, J. "Autonomous Work Groups"
Industrial Society, July/Aug. 1974
72. Birchall, D.W.
Wild, R. "Group Working"
Work Study & Management Services
October, 1973
73. Nordhof, D. "Work Structuring and Consultation at Phillips"
Industrial Participation,
Summer, 1974
74. Gyllenhammar, P. "Changing Work Organisation at Volvo"
Industrial Participation, Spring 1974

75. Vonsild, N.O. "Case Study - Bang & Olufson"
Seminar: Effective Production and
Worker Motivation,
H.B.Maynard & Co. 27 January, 1976
76. Hartley, J. "Productivity and Conditions, Boost
with Group Assembly"
The Engineer, 7th October, 1976
77. Fazakerley, G.M. "Group Technology - Social Benefits
and Social Problems"
The Production Engineer, Oct. 1974
78. Fazakerley, G.M. "A Research Report on the Human
Aspects of Group Technology and
Cellular Manufacture"
International Journal of Production
Research, 1976, Vol. 14, No.1
79. Kruse, G. "Feasibility Study for the Implemen-
tation of a G.T. System in a Multi-
Product Company"
Unpublished M.Phil. Thesis
The University of Aston in Birmingham
June, 1974
80. Opitz, H. "Werkstücksystematik und
Teilefamilienfertigung"
V.D.I. - Zeitschrift, (1964) No.26

81. Burbidge, J.L. "The Introduction of Group Technology"
Heinemann, 1975
82. Mitrotanov, S.P. "Scientific Principles of Group
Technology"
NLL Translation, 1966
83. Heginbotham, W.B. "Where Goes Industrial Robot
Technology"
The Production Engineer, March 1976
84. Rathmill, K. "An Evaluation of Production Cost and
Control Effectiveness in G.T. and
Functional Layout"
Conference "Modern Production
Management Practice" UMIST, 14th
and 15th July, 1976
85. Francis, B.W.R. "A Study of Component Flow for the
Application of Group Technology
Techniques"
Unpublished M.Sc. Thesis, The
University of Aston in Birmingham,
October, 1974
86. Burns, C.R. "Quality Control Benefits Arising
from G.T. Applications"
Conference "Control Aspects of Group
Technology Systems"
The Institution of Production

- Engineers, De Vere Hotel, Coventry,
20th and 21st November, 1974
87. Wallace, T.A.H. "Quality Assurance in G.T."
McIntosh, N.G. Conference "Control Aspects of Group
Technology Systems"
The Institution of Production
Engineers, De Vere Hotel, Coventry,
20th and 21st November, 1974
88. Alcalay, J.A. "A Proposal for a General Model of
Buffa, E.S. Production System"
International Journal of Production
Research, April 1st, 1963
89. Gustafson, J.F. "Logistics"
Hagemann, R.G. Production and Inventory Management,
3rd Qtr., 1976.
90. Mather, H.F. "The Master Production Schedule"
Plossl, G.W. G.W. Plossl & Co. Inc., 1975
91. New, C. "M.R.P. + G.T., A New Strategy for
Component Production"
The Institution of Production
Engineers, Group Technology Div.,
November, 1975

92. - "Sperry Univac - a Management Review -
Planning for Effective Manufacturing
Control Systems"
Sperry Univac Publication, U5880
93. Burbidge, J.L. "Principles of Production Control"
Macdonald & Evans, 1968.
94. Burbidge, J.L. "Individual Replies to a Paper by
Duckworth, E. T.B. Tate "In Defence of the
Economic Batch Quantity"
Operational Research Quarterly,
Vol.15, No.4
95. Rathmill, K. "Batch Size Selection for Group
Brunn, P. Technology"
Leonard, R. Conference: Modern Production
Management in Practice,
UMIST, 14th - 15th July, 1976
96. Thornley, R.H. "The Scheduling of Work Through a
Beaumont, G. Cell"
The Institution of Production
Engineers, Group Technology Division
November, 1975
97. Brown, R.G. "Statistical Forecasting for
Inventory Control"
McGraw-Hill, 1959

98. Eilon, S. "Production Planning and Control"
Macmillan & Co., 1962
99. Theisen, E.C. "New Game in Town - the MRP lot size"
Production and Inventory Management
2nd Qtr., 1974
100. More, S.M. "MRP and the Least Total Cost Method
of Lot-Sizing"
Production and Inventory Management
2nd Qtr., 1974
101. Berry, W.L. "Lot Sizing Procedures for Require-
ments Planning Systems: a Framework
for Analysis"
Production and Inventory Management
Vol. 13, No. 2, 1972
102. Silver, E.A. "A Control System for Co-ordinated
Inventory Replenishment"
International Journal of Production
Research, 1974, Vol.12, No.6
103. Leonard, R.
Rathmill, K. "The Fundamental Limitations of
Cellular Manufacture when Contrasted
with Efficient Functional Layout"
University of Manchester, Institute
of Science and Technology
104. Duckworth, E. "A Guide to Operational Research"
Methuen & Co., 1969

105. Teague, R.J. "Quality Opportunities in Group Technology"
Conference "Control Aspects of Group Technology Systems"
The Institution of Production Engineers, De Vere Hotel, Coventry,
20th and 21st November, 1974
106. Elliot, J. "Qualified Success for Volvo Assembly"
Financial Times, 23.11.77
107. McGregor, D. "The Human Side of Enterprise"
McGraw-Hill, 1960
108. Dale, B.G. "The Need to Predict the Potential
Willey, P.C.T. for Group Technology on Manufacture"
Machinery and Production Engineering
5th January, 1977
109. Scanlon, B.K. "Determinants of Job Satisfaction
and Productivity"
Personnel Journal, January 1976
110. Pullen, R.D. "A Survey of Cellular Manufacturing
Cells"
The Production Engineer, September,
1976

111. Guest, D
Fatchett, D. "Worker Participation: Individual
Control and Performance"
Institute of Personnel Management,
1974
112. Fazakerley, G.M. "Why are People a Problem in
Production Systems"
Manufacturing Systems, Vol.4, No.4,
1975
113. Galbraith, J.K. "The Affluent Society"
Penguin, 1962
114. Leonard, R. "Group Technology Myths"
Management Today, January, 1977
115. Leighton, M. "Journey into the Working Class"
Sunday Times, January 16, 1966
116. Merchant, M.E. "Economic, Social and Environmental
Considerations for Computer Automated
Manufacturing Systems"
Manufacturing Systems, Vol.4, No.4,
1975
117. - "Dawn for the Day of the Unmanned
Factory Glimmers from the East"
The Engineer, 20th January, 1977
118. - "Out of Production"
Industry Week, January 5th, 1976

119. Lloyd, P.A. "Incentive Payment Schemes"
BIM Management Survey Report No.34,
1976
120. Rathmill, K. "Characteristics of Future Batch
Leonard, R. Production Systems"
Davies, B.J. The Chartered Mechanical Engineer,
March, 1977
121. Opitz, H. "Moderne Produktionstechnik"
W. Girardet Verlag, 1970
122. Crozier, M. "The Bureaucratic Phenomenon"
University of Chicago Press, 1967
123. - "The Incentives Dilemma"
The Engineer, 27th January, 1977
124. Collino, E.J. "The Economics of Manufacturing
Processes"
I.Prod.E. - Plymouth Management
Centre Seminar "The Management of
Design for Economic Production",
Portsmouth Management Centre,
2nd - 4th June, 1976
125. Wild, R. "Mass Production Work"
Journal of General Management
No. 3, 1976

126. Schumacher, E.F. "Small is Beautiful"
Blond and Briggs, 1973
127. Mather, H.F. "Manufacturing Control In Perspective"
Production and Inventory Management
4th Qtr. 1976
128. Martino, R.L. "Integrated Manufacturing Systems"
McGraw-Hill, 1972

Key Company Objective	maximise profit	maximise return on assets	minimise labour fluctuations	ensure long term growth	maximise sales
Subsidiary Objective					
minimise cost	X	X		X	X
minimise inventory		X		X	
minimise debtors		X		X	
minimise fixed assets		X		X	
maximise delivery performance				X	X
minimise delivery time				X	X
maximise quality levels				X	X
minimise quality cost	X	X			
maximise technical performance					X
follow market fluctuations					X
maximise price	X	X			
maximise sales	X	X			
minimise price					
limit output fluctuations			X		X

TABLE I:- KEY OBJECTIVE ANALYSIS

TABLE III

ORDER LEAD TIME

	Existing mean time (weeks)	Proposal mean time (weeks)
Receive order		
Update stock status	0.5	0.5
Issue purchase requisition (P.R.))	
Check P.R. and due date)	
Schedule and issue order documentation	2.0)	
Prepare batch documentation)	
Check material availability	0.5)	0.5
Issue material P.R.)	
Issue material order to supplier	0.2)	
Material lead time	18.0	18.0
Receive material		
Inform material records section		
Inform machine shop control	0.5	0.5
Machine shop lead time	6.7	3.0
Receive in store		
Update stock status		
Assembly draw off	1.0	0.5
Issue assembly order, assembly & test	4.0	1.0
Machining/Assembly buffer	2.0	1.0
TOTAL:	<u>35.4</u>	<u>25.0</u>
with material procurement decoupled	<u>16.7</u>	<u>6.5</u>

TABLE IV

Happiness is this shape...

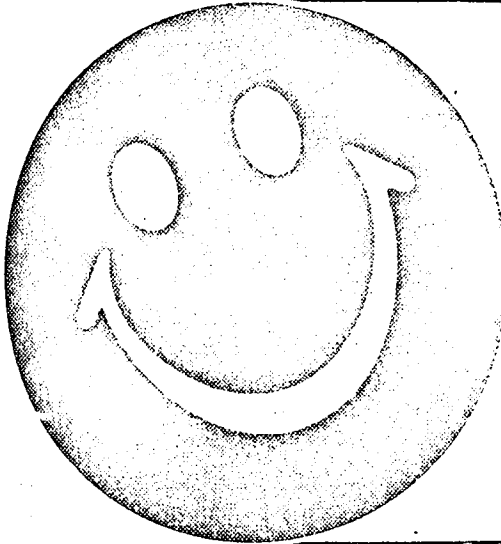

	SINGLE MEN	SINGLE WOMEN	MARRIED MEN	MARRIED WOMEN
FRIENDS AND SOCIAL LIFE	1	1	8	7
JOB OR PRIMARY ACTIVITY	2	3	4	7
BEING IN LOVE	3	2	2	1
RECOGNITION, SUCCESS	4	4	7	5
SEX LIFE	5	6	6	4
PERSONAL GROWTH	6	5	1	5
FINANCIAL SITUATION	7	9	10	13
HOUSE OR APARTMENT	8	10	11	14
BODY AND ATTRACTIVENESS	9	8	16	16
HEALTH PHYSICAL CONDITION	9	7	13	9
CITY YOU LIVE IN	11	13	14	11
RELIGION	12	10	12	12
EXERCISE, RECREATION	13	12	15	15
BEING A PARENT			9	10
MARRIAGE			3	2
PARTNER'S HAPPINESS			5	3

TABLE V

MACHINED PARTS LEAD TIMES

Batch No.	Batch Qty.	Batch Hours	Batch Days	Wait and Move Allowances	Total + Admin. Lead time	Allowed Lead times on Stock Status
1	120	69	4	20	34	40
2	450	161	10	19	39	40
3	150	179	11	29	50	40
4	140	148	9	29	48	40
5	150	211	13	28	51	40
6	675	304	19	26	55	30
7	130	66	4	19	33	25
8	380	168	10	20	40	40

TABLE VI

PILOT CELL OPERATING RESULTS

	Pre-Cellular	Cellular
Batch throughput time		
average weeks	12	3
minimum weeks	7	1
maximum weeks	29	5
Productivity ratio		
<u>Standard hours produced</u> Attendance hours	0.77	0.87
Scrap value (per quarter) £	715	340
Direct labour output		
Standard hours per man per day	5.9	<u>6.6</u>

TABLE VII (b)

PRODUCT CENTRE PARTS CYCLING - SPOOLS

Part No.	Number of cycles per year		Proposed	% Cost Penalty
	with E.B.Q.	E.B.Q. plus 5% penalty maximum minimum		
1	6.9	34.8 1.2	12	0.6
2	1.2	2.7 0.5	2	1.6
3	1.0	2.1 0.4	2	5.0
4	2.8	9.3 0.8	12	7.7
5	2.7	8.7 0.8	12	8.5
6	2.9	10.0 0.9	12	6.9
7	3.5	19.4 0.9	12	3.2
8	3.5	13.1 0.9	12	4.3
9	1.3	3.1 0.5	2	1.0
10	2.8	9.5 0.9	12	7.5
			Total	3.7

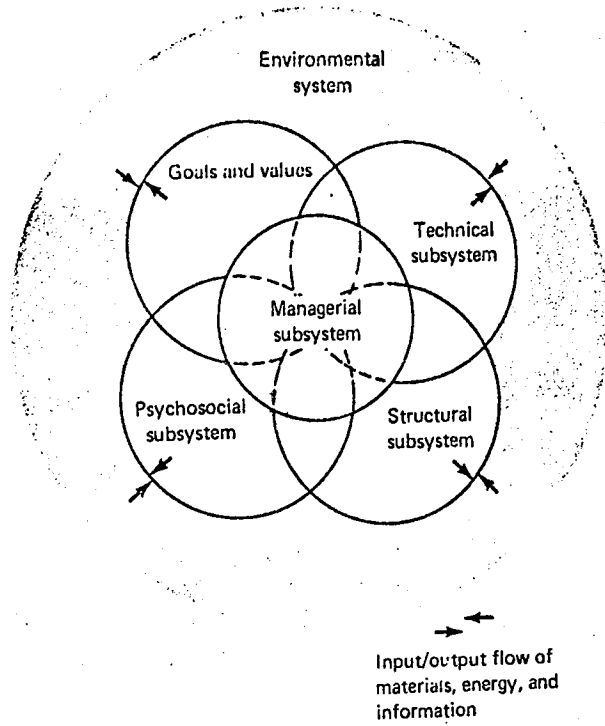

THE ORGANISATIONAL SYSTEM

(AFTER KAST, JOHNSON & ROZENZWEIG)

FIGURE 1

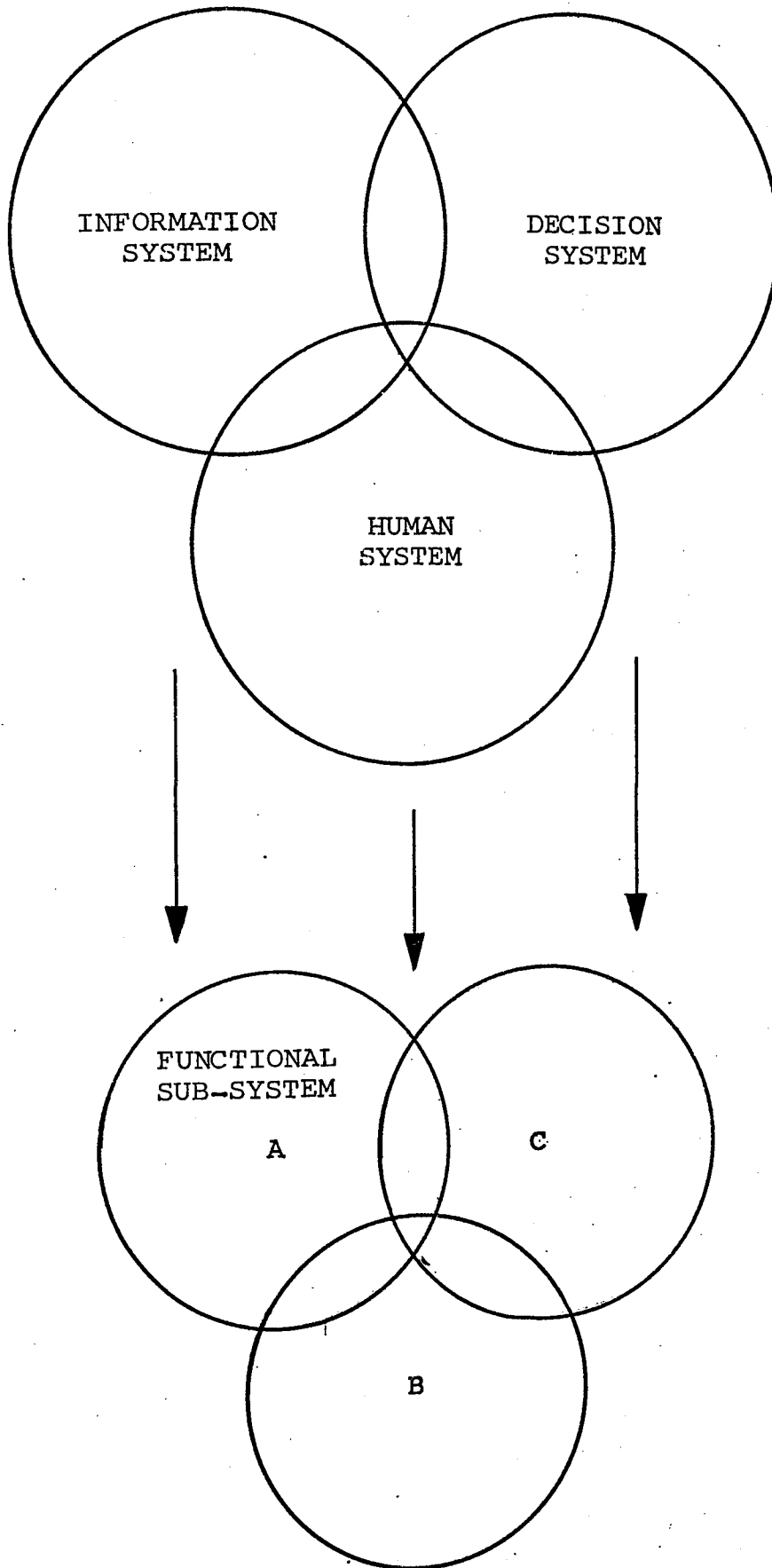

RELATIONSHIP OF BUSINESS SUB - SYSTEMS

FIGURE 2

INTEGRATED GROUP TECHNOLOGY

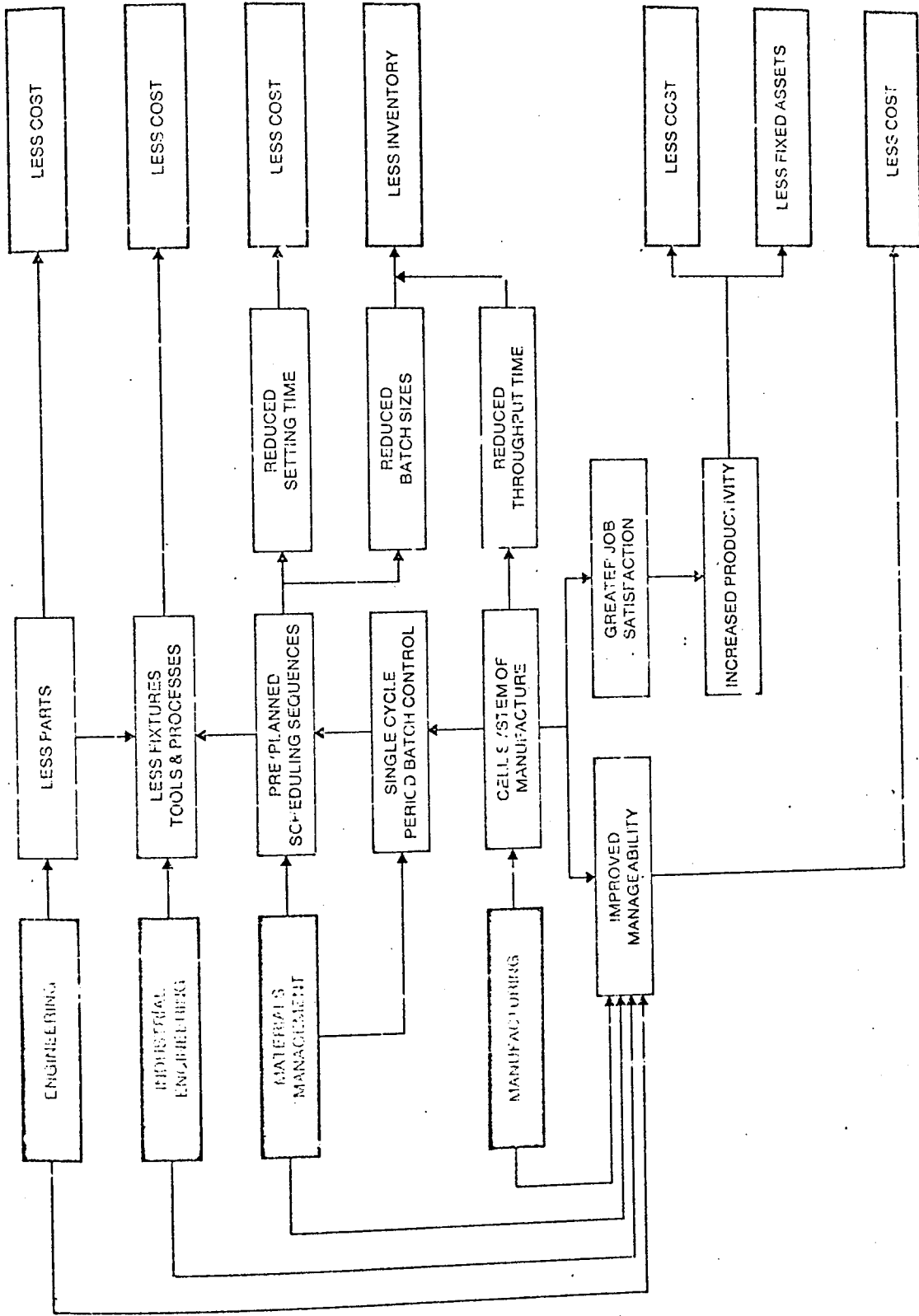

INTEGRATED GROUP TECHNOLOGY

FIGURE 3

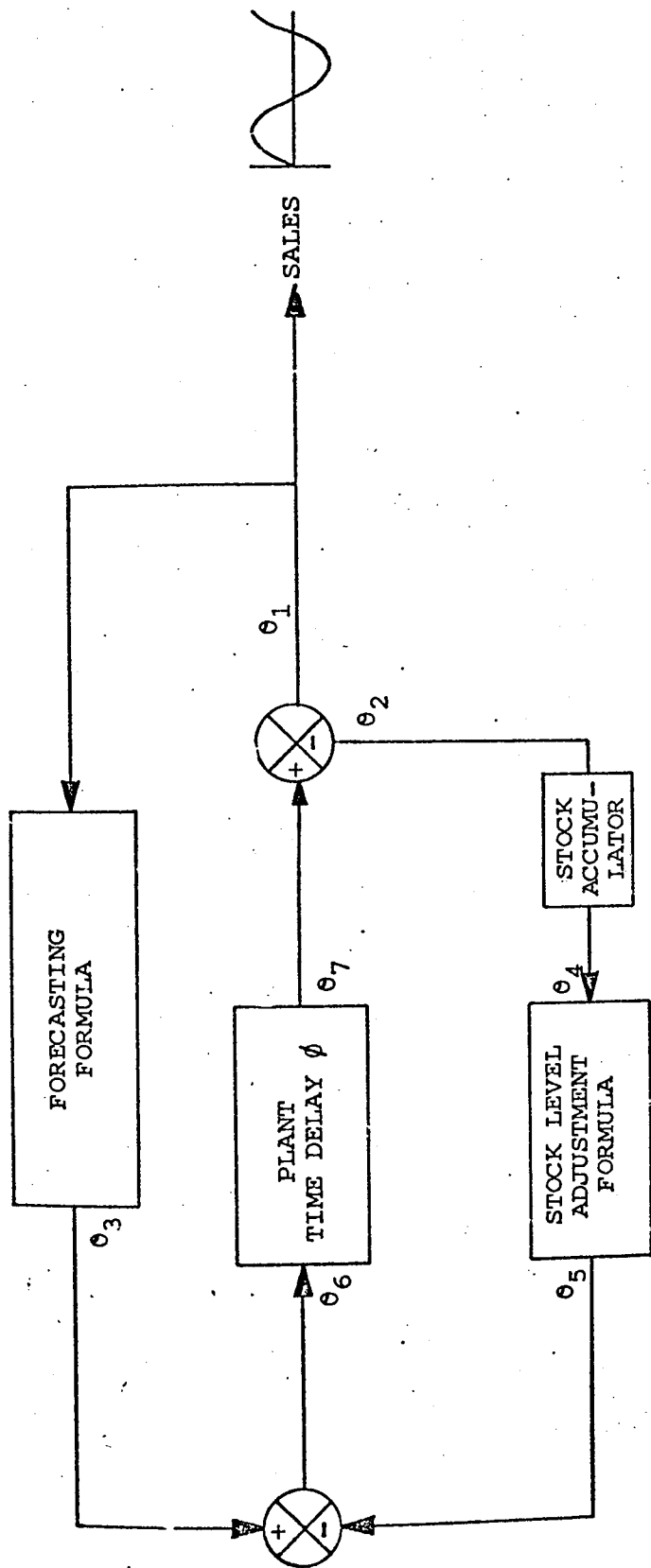

PLANT CONTROL SYSTEM - BLOCK DIAGRAM

FIGURE 4

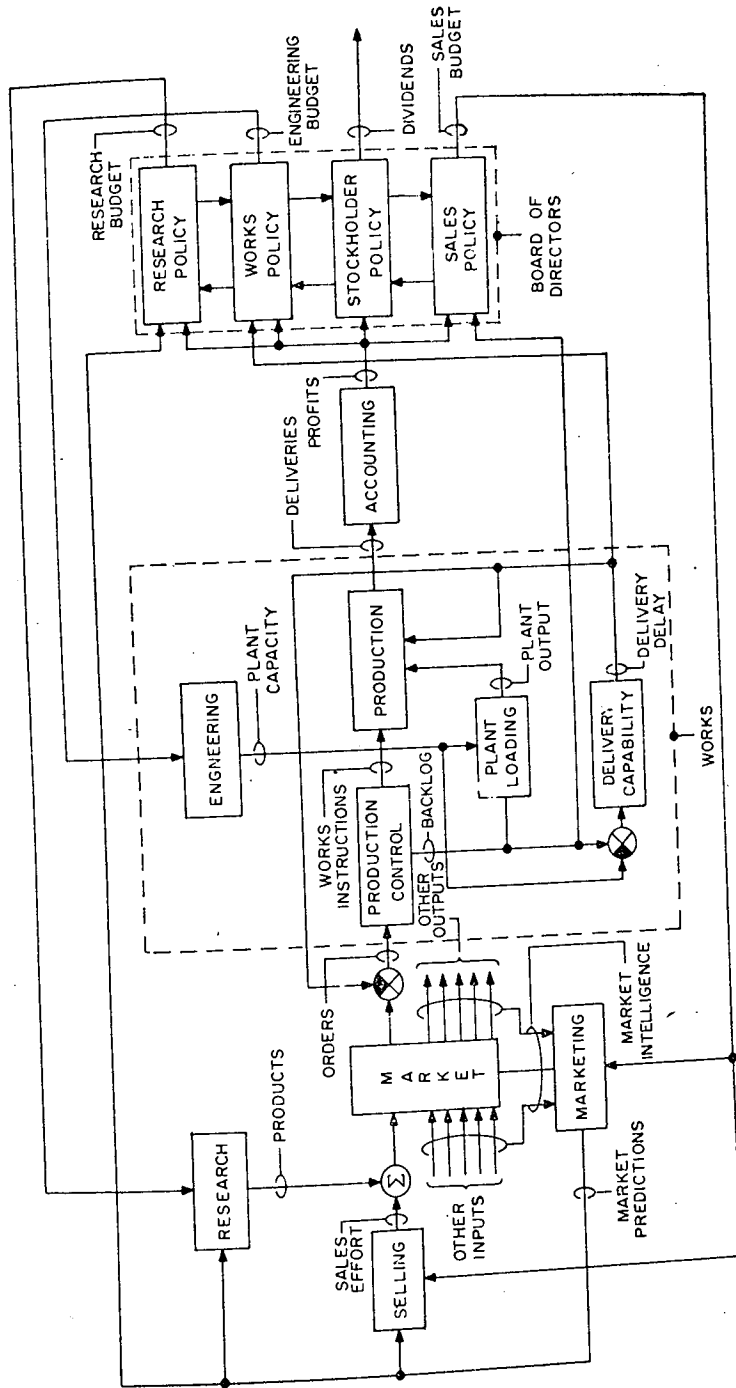

A SIMPLIFIED REPRESENTATION OF A
 MANUFACTURING COMPANY AS A
 CLOSED-LOOP SYSTEM (AFTER ROOTS)

FIGURE 5

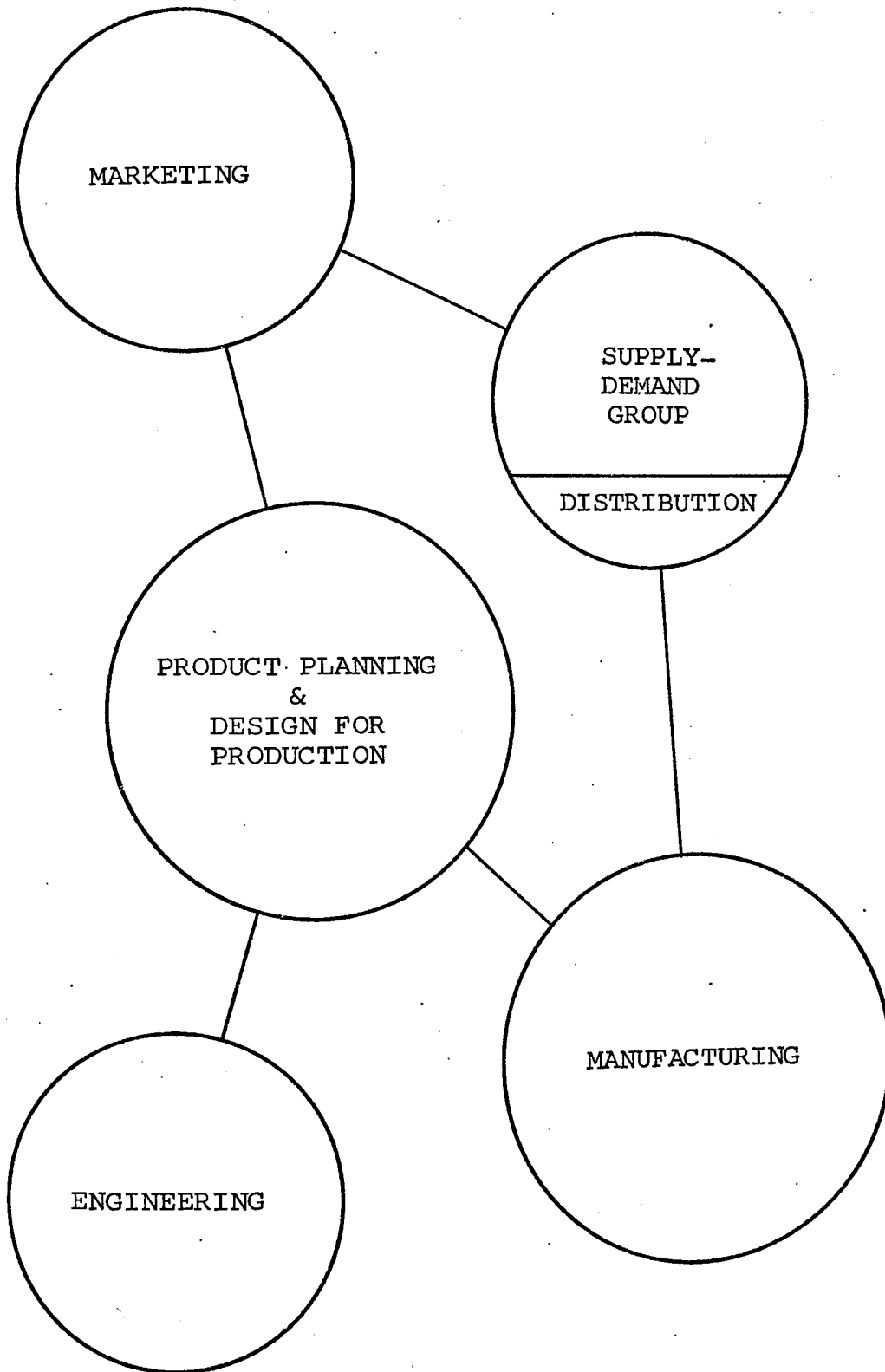

COMPANY SUB - SYSTEMS

FIGURE 6

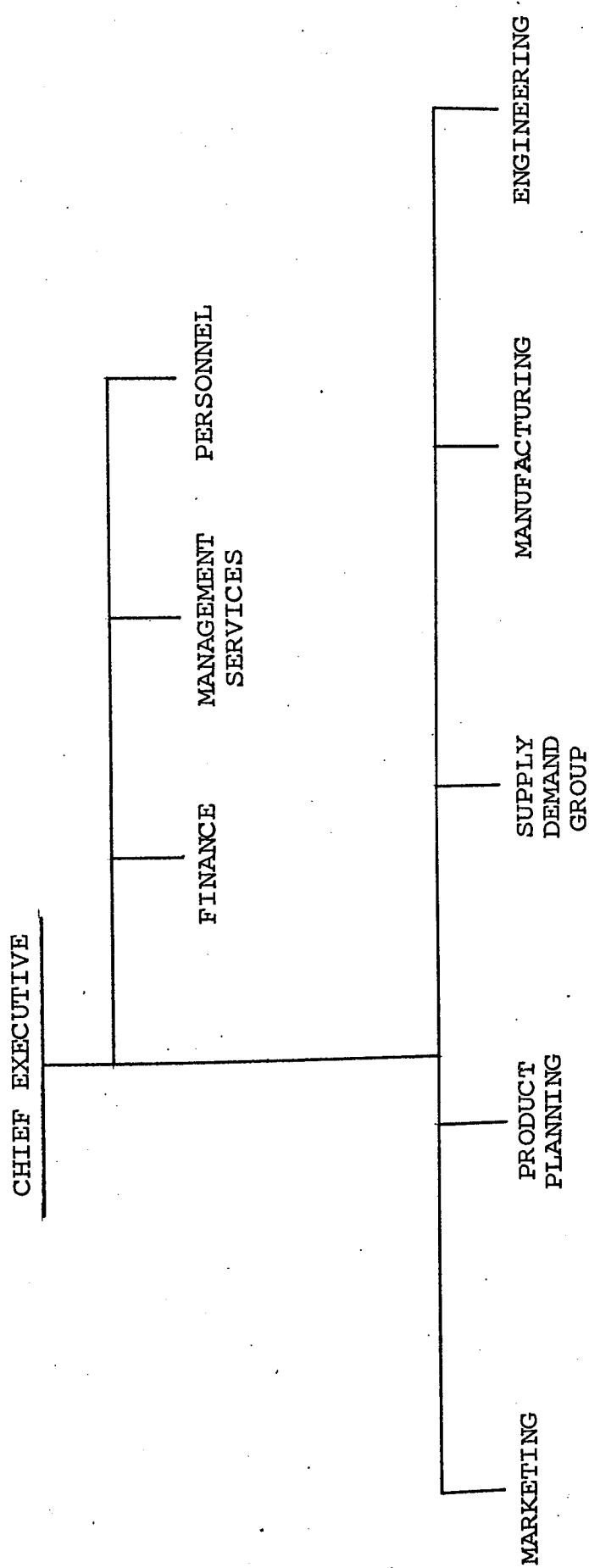

COMPANY ORGANISATION STRUCTURE

COMPANY ORGANISATION STRUCTURE

Fig. 7

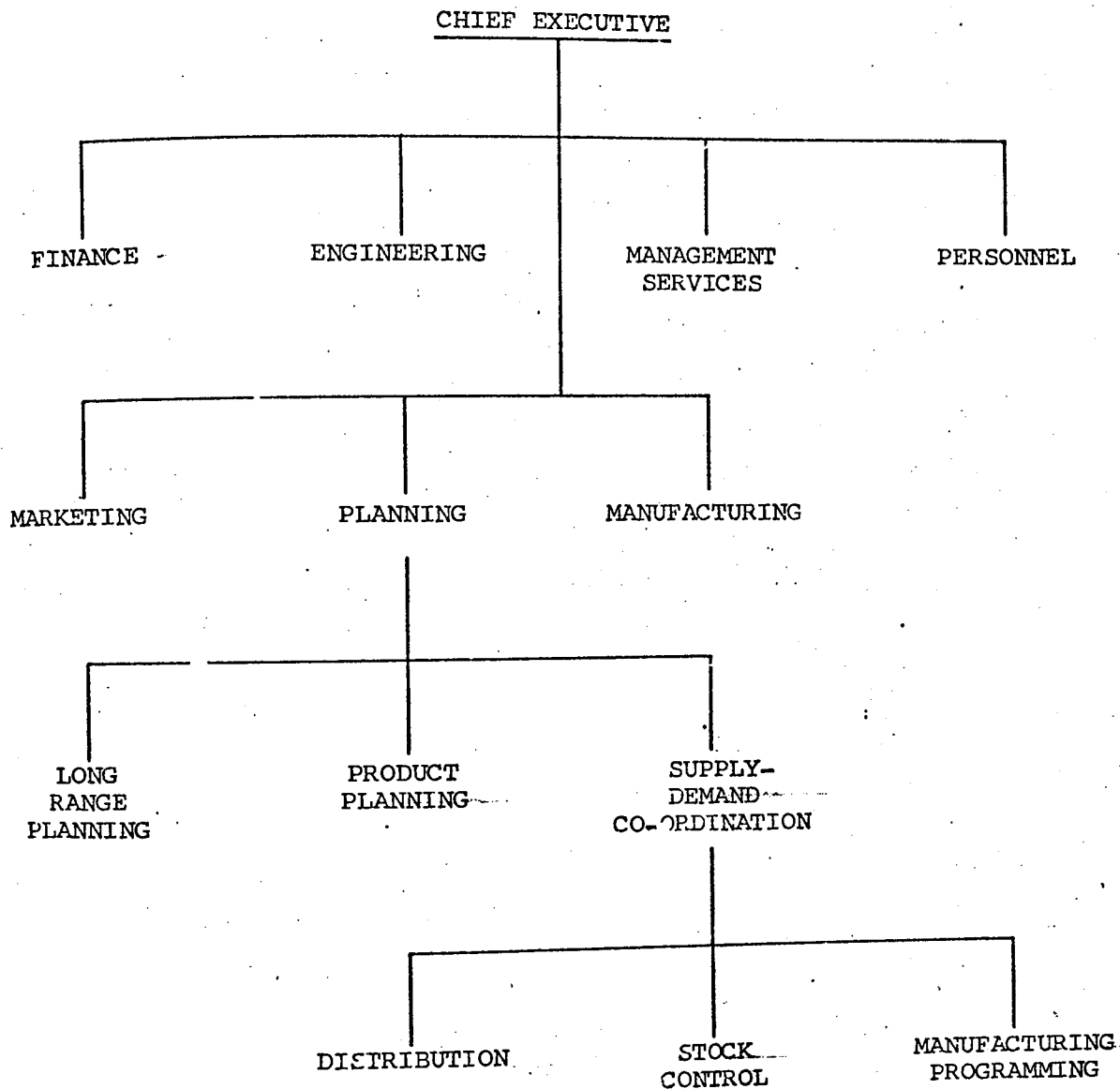

COMPANY ORGANISATION STRUCTURE

Fig. 8

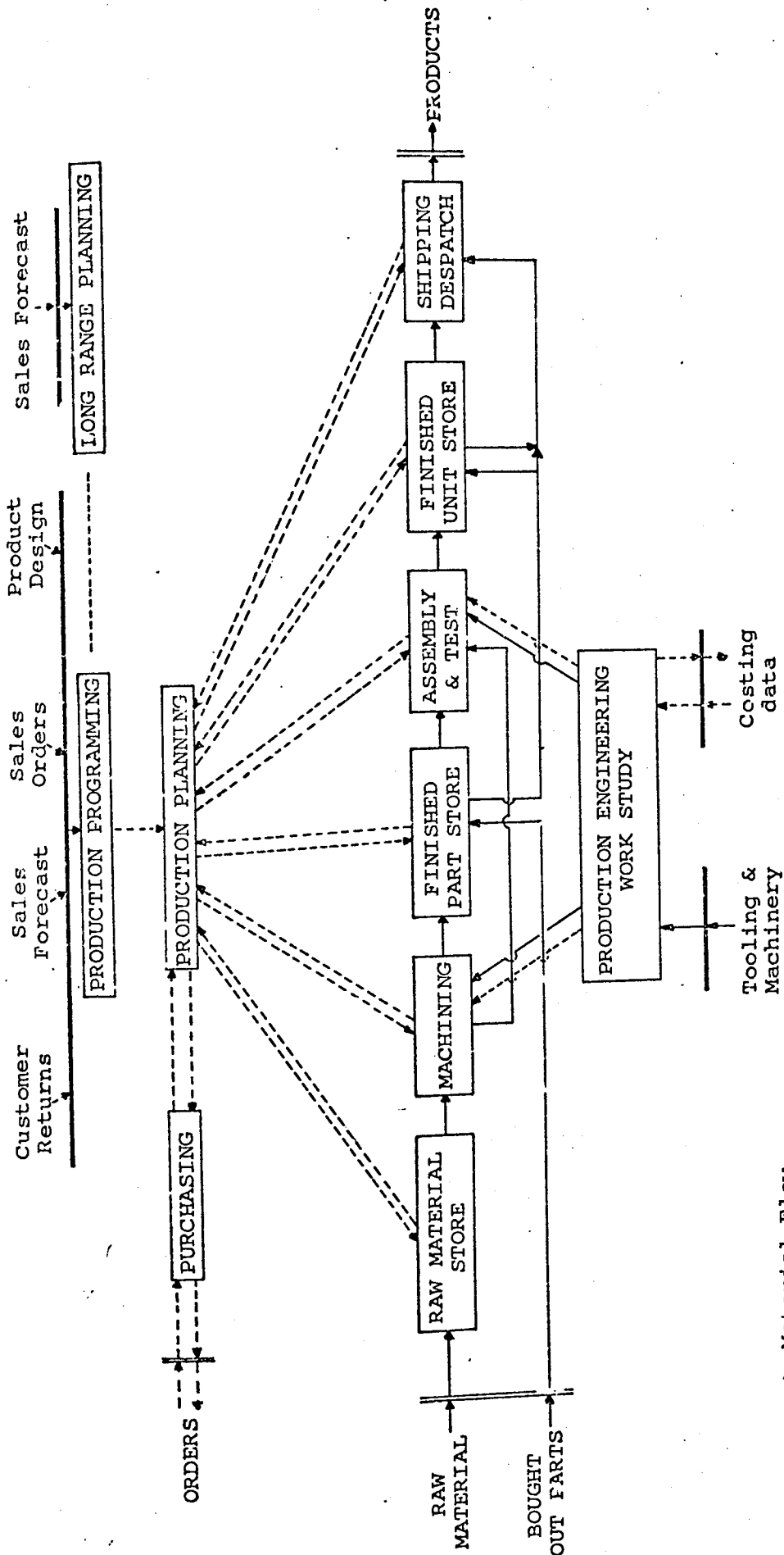

MANUFACTURING SYSTEM - BLOCK DIAGRAM

FIGURE 9

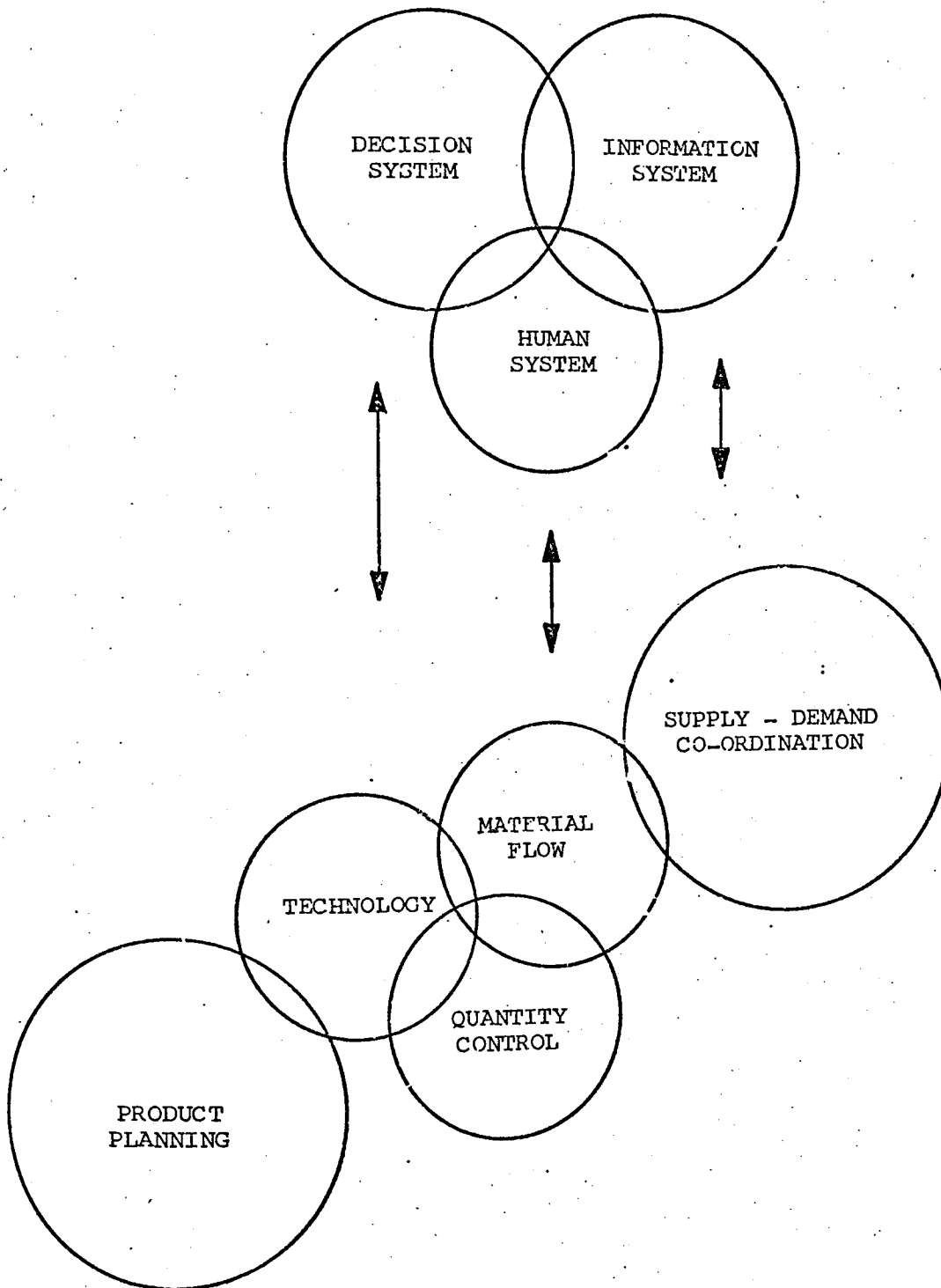

RELATIONSHIP OF MANUFACTURING SUB-SYSTEM

FIGURE 10

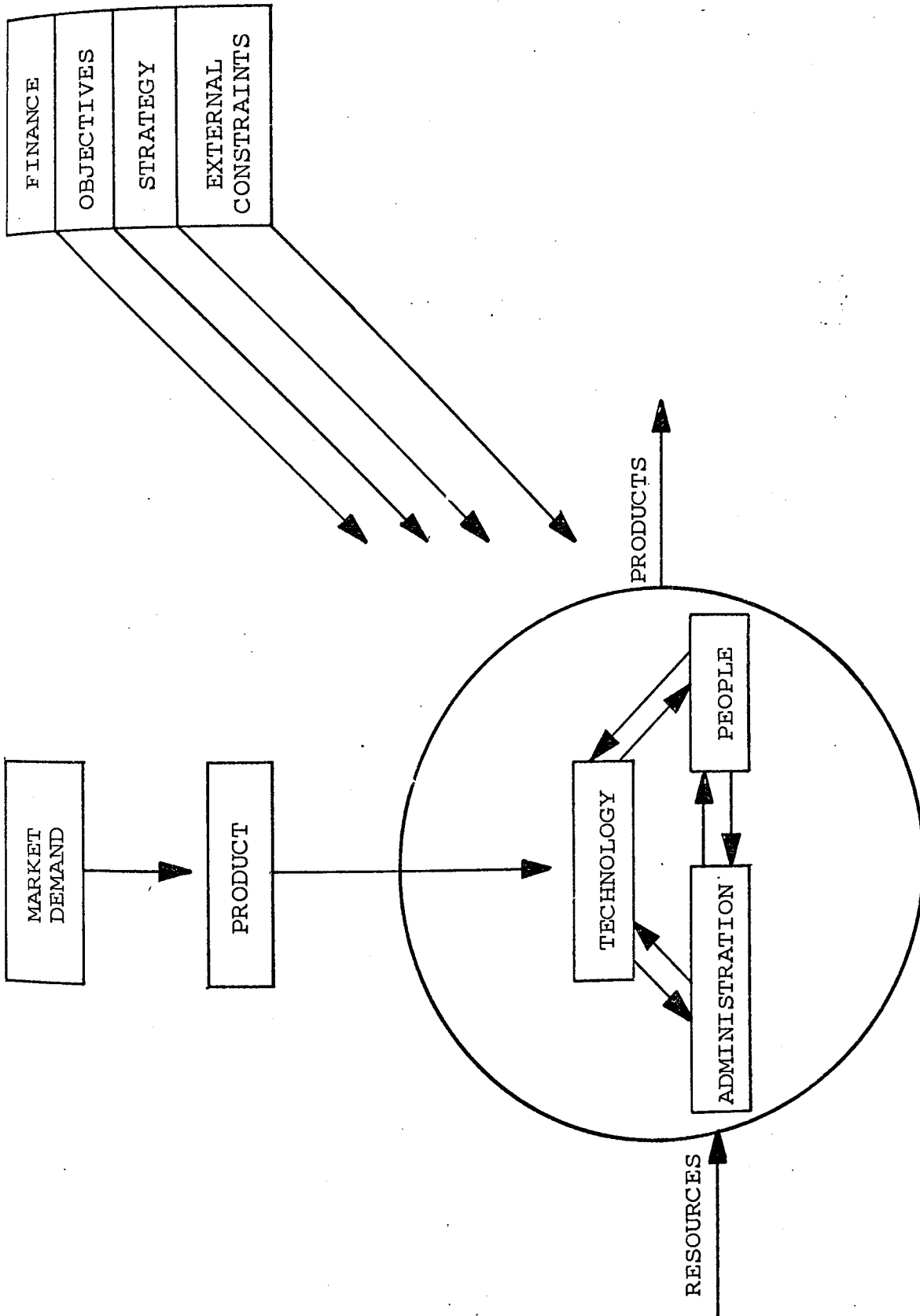

MANUFACTURING ENVIRONMENT

FIGURE 11

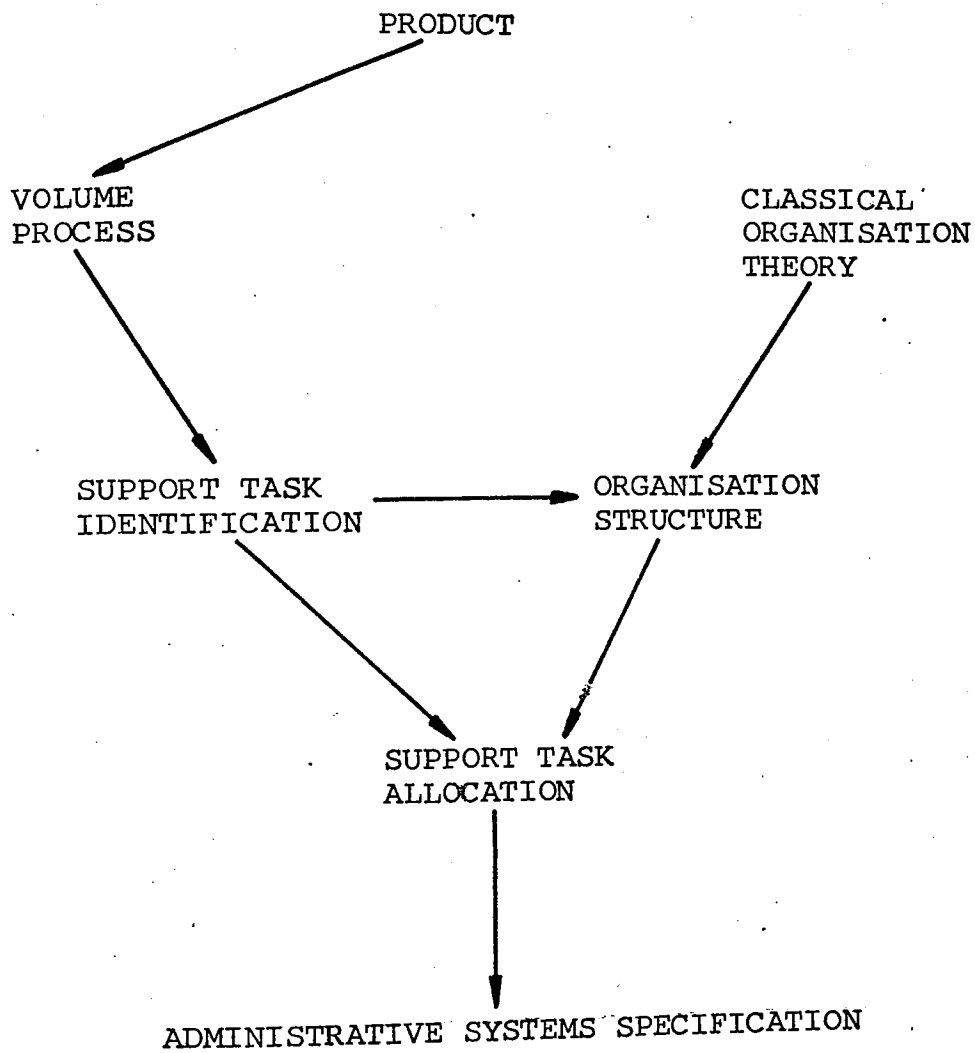

MANUFACTURING SYSTEMS DESIGN

OLD APPROACH

FIGURE 12

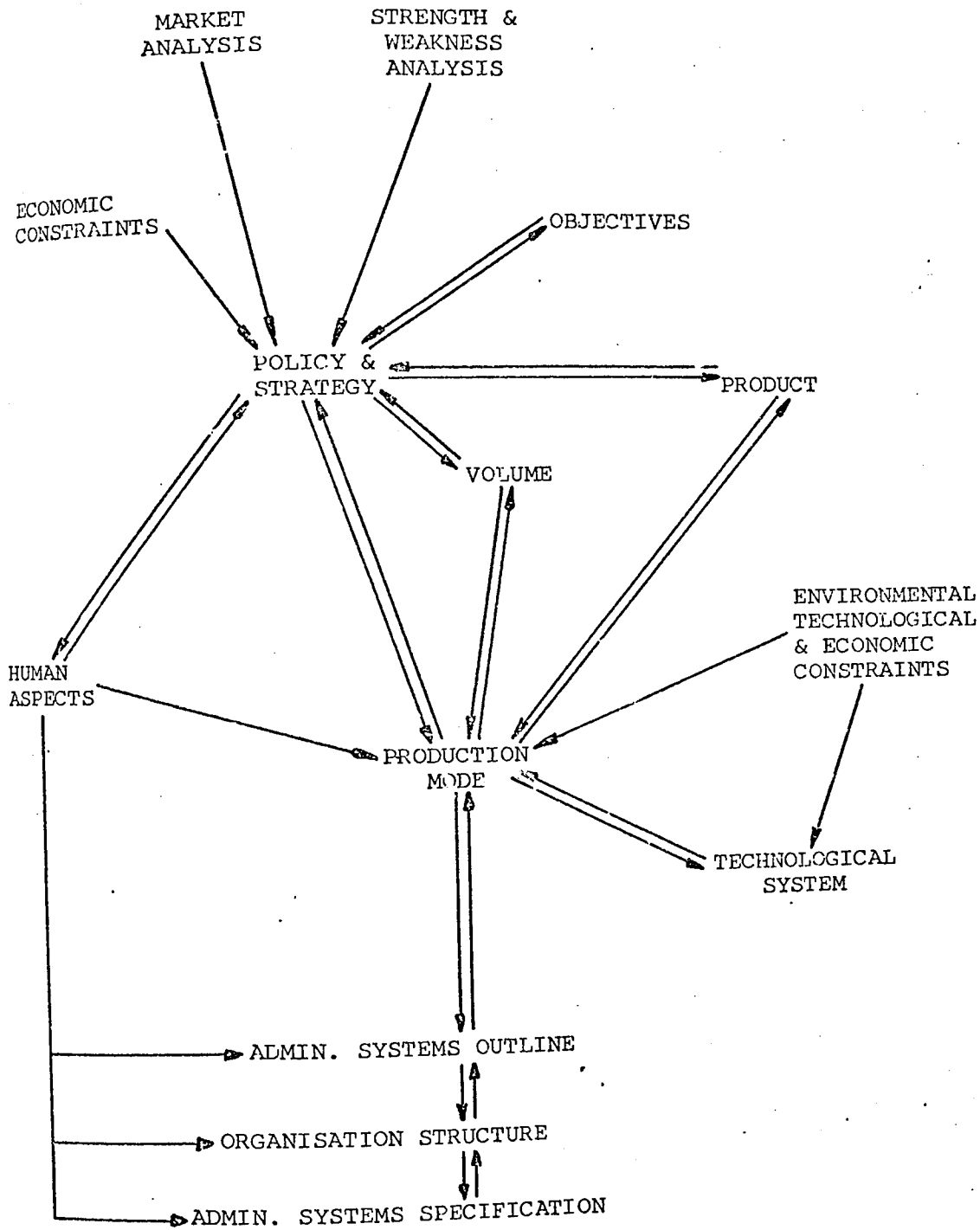

MANUFACTURING SYSTEMS DESIGN.

NEW APPROACH

FIGURE 13

HIERARCHICAL
LEVEL

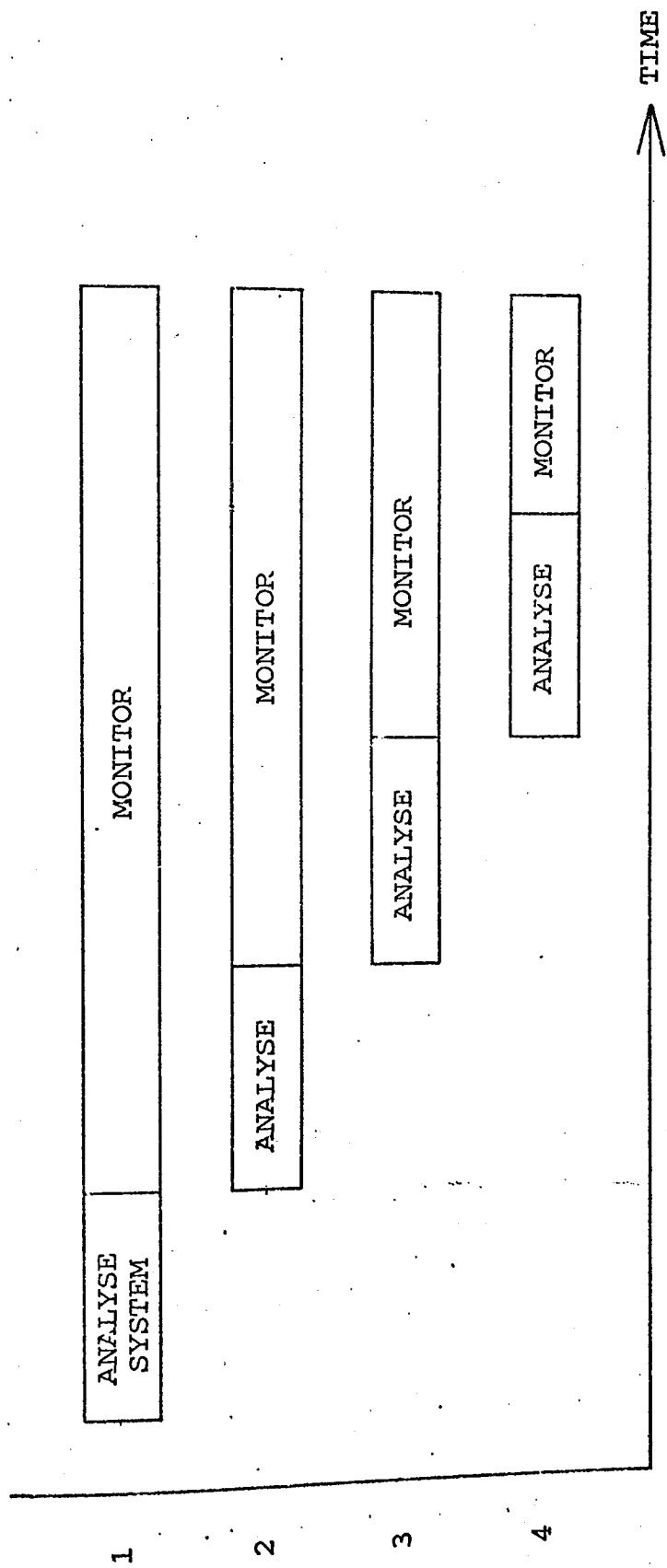

SYSTEMS STUDY TIME PHASING

FIGURE 14

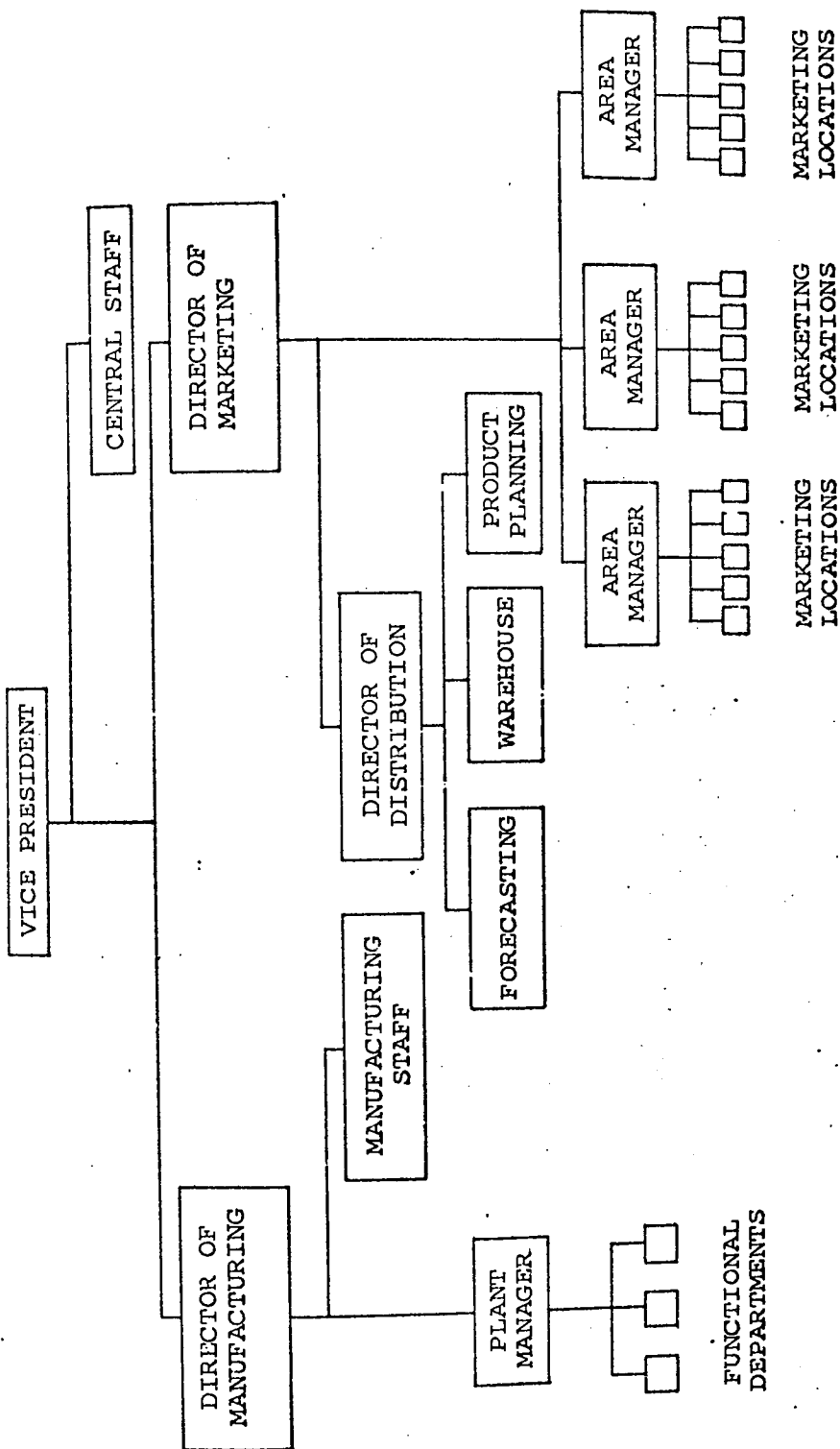

DIVISIONAL ORGANISATION STRUCTURE

FIGURE 15



Aston University

Illustration has been removed for copyright restrictions

THE BUSINESS CYCLE (SUNDAY TIMES)

FIGURE 16



Aston University

Content has been removed for copyright reasons

GENERAL SYSTEM OUTLINE

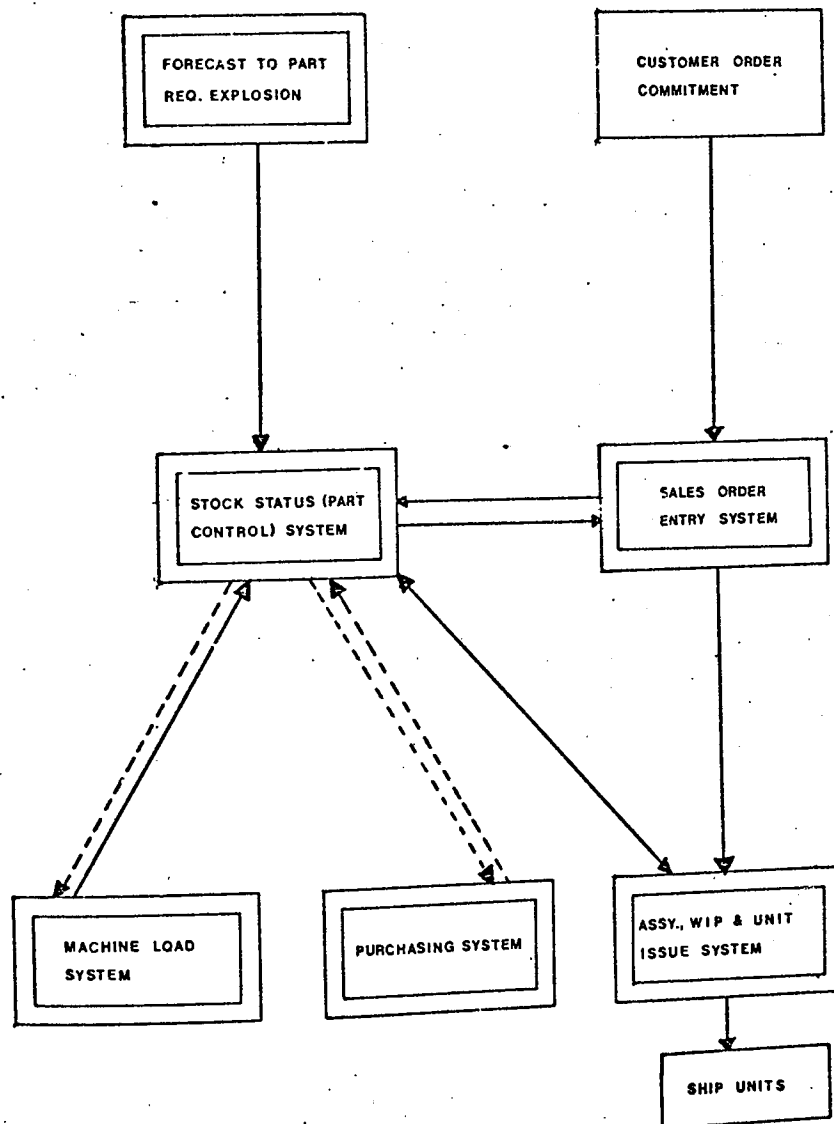

FIGURE 19

IN HOUSE PART CONTROL

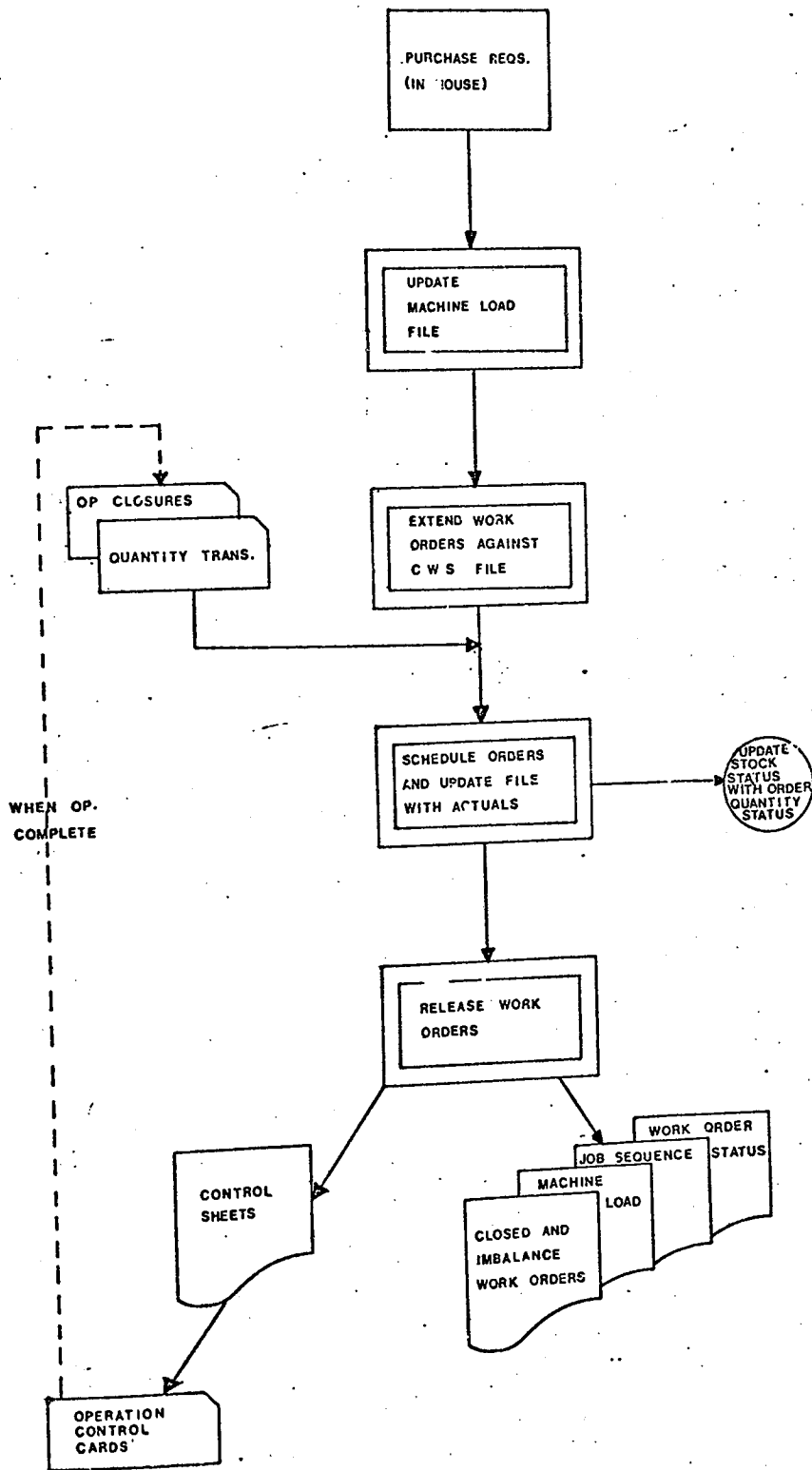

FIGURE 20

VENDOR PART CONTROL

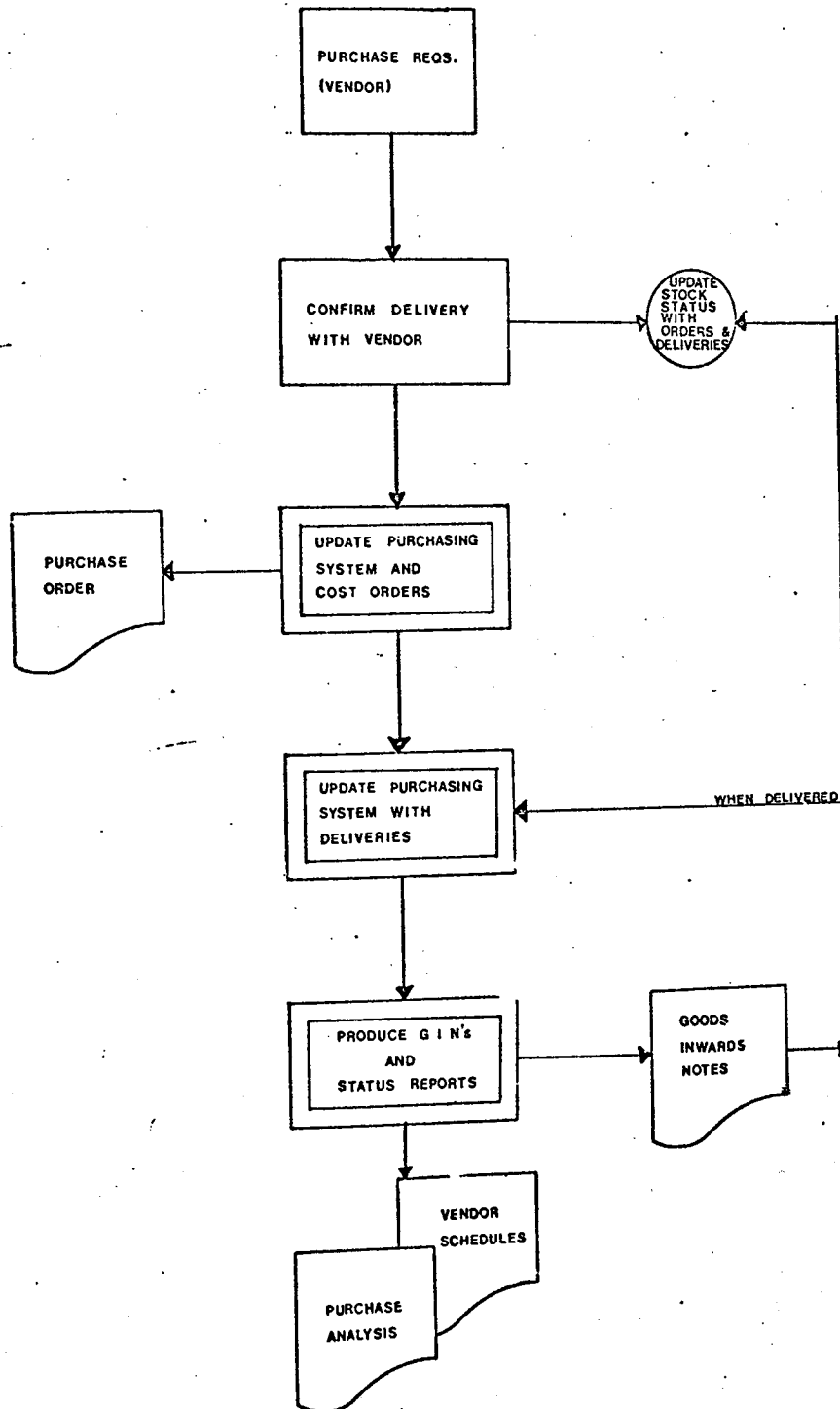

FIGURE 21

ORDER BUILD

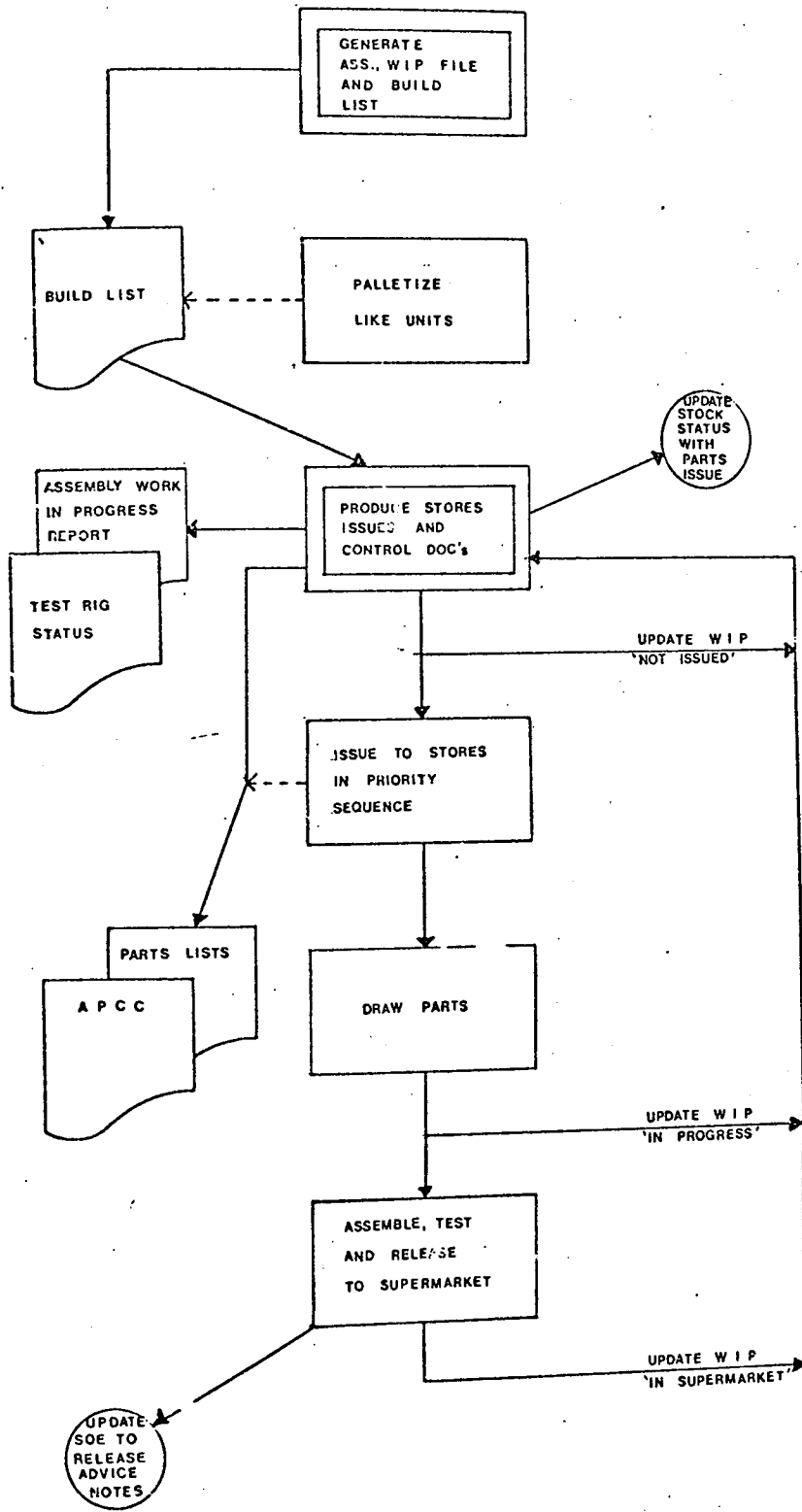
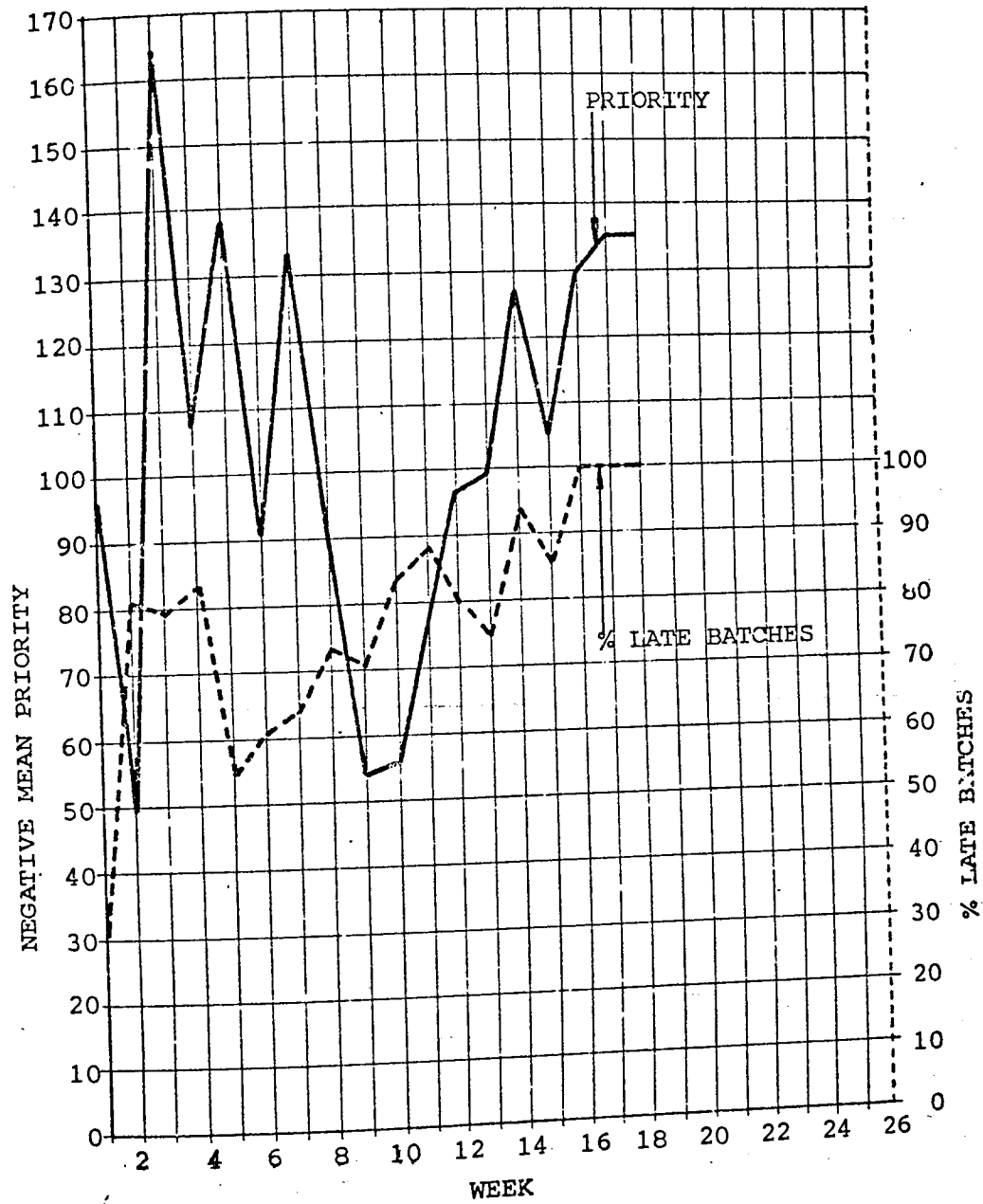

FIGURE 22



WORKS ORDER DELAY PATTERN

MACHINE NUMBER 020961

FIGURE 25

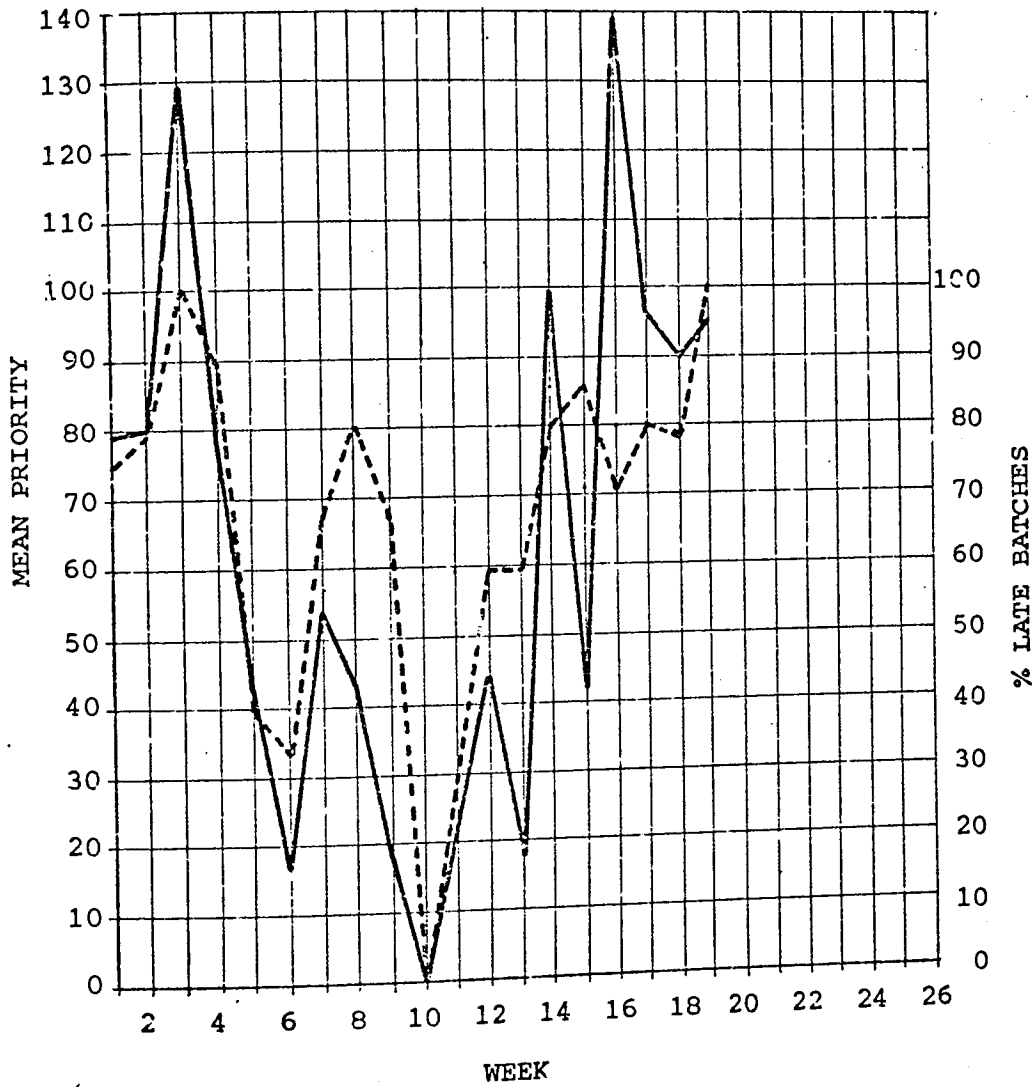

WORKS ORDER DELAY PATTERN

MACHINE NUMBER 002038

FIGURE 24

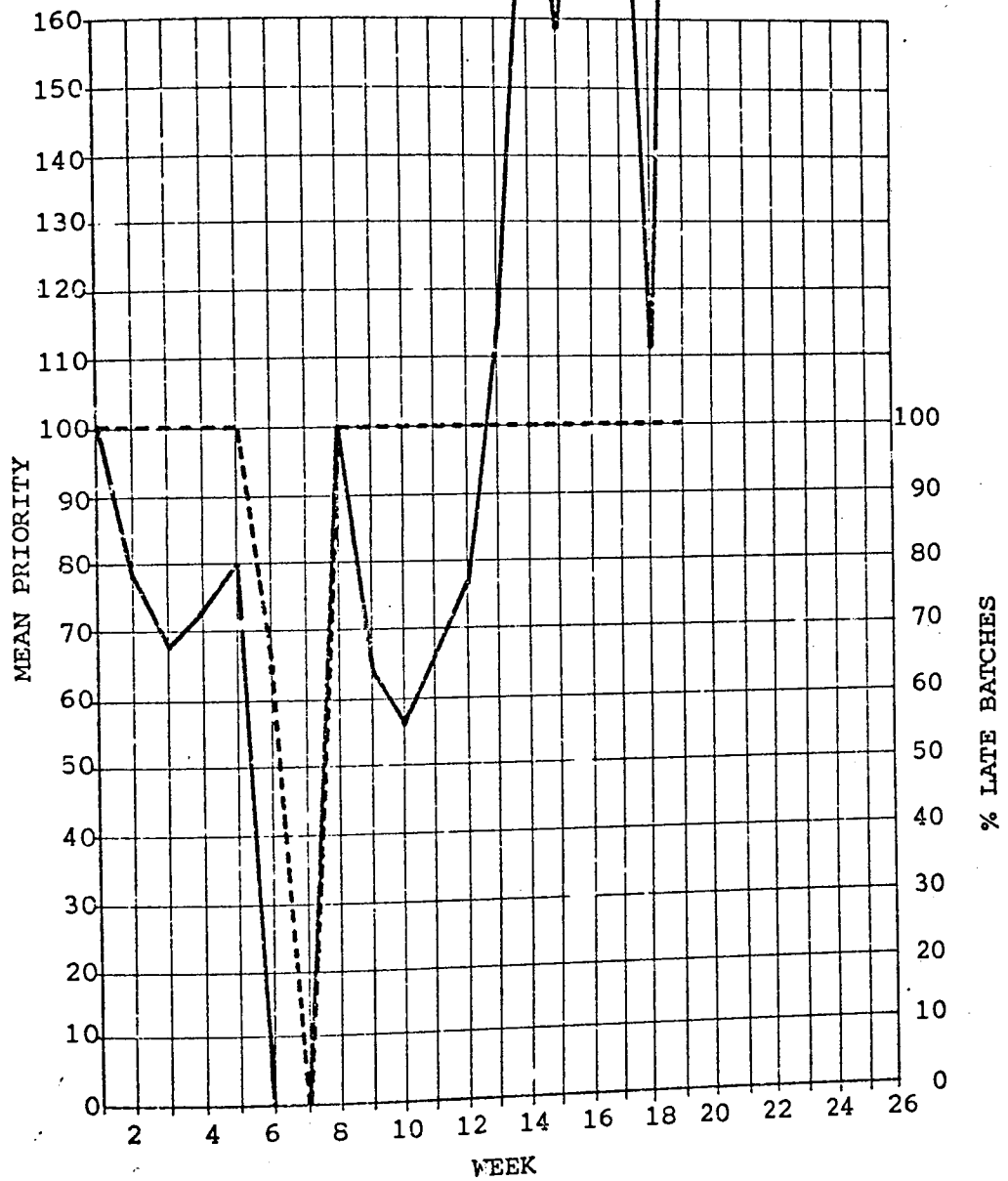

WORKS ORDER DELAY PATTERN

MACHINE NUMBER 000951

FIGURE 25

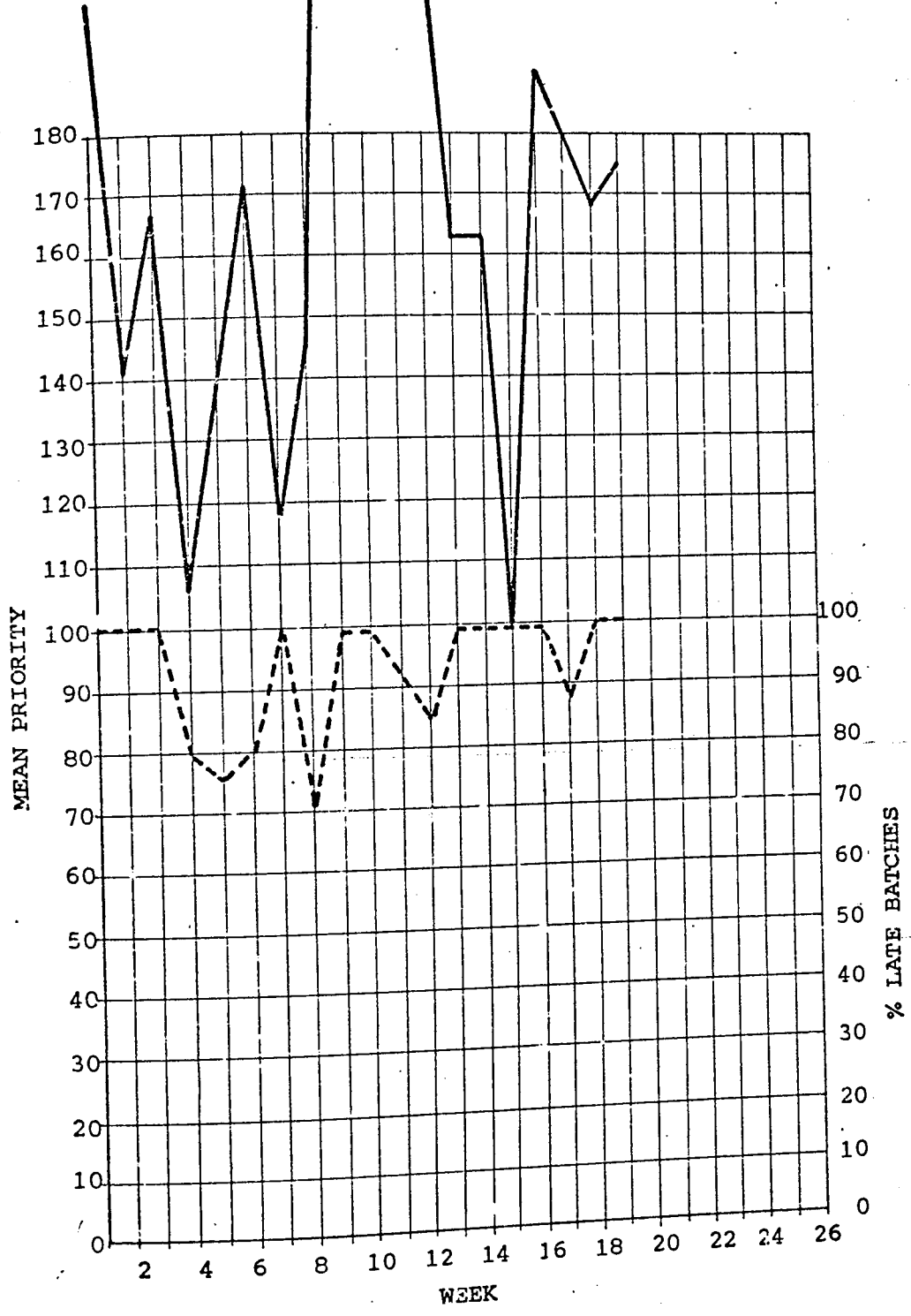

WORKS ORDER DELAY PATTERN

MACHINE NUMBER 050013

FIGURE 26

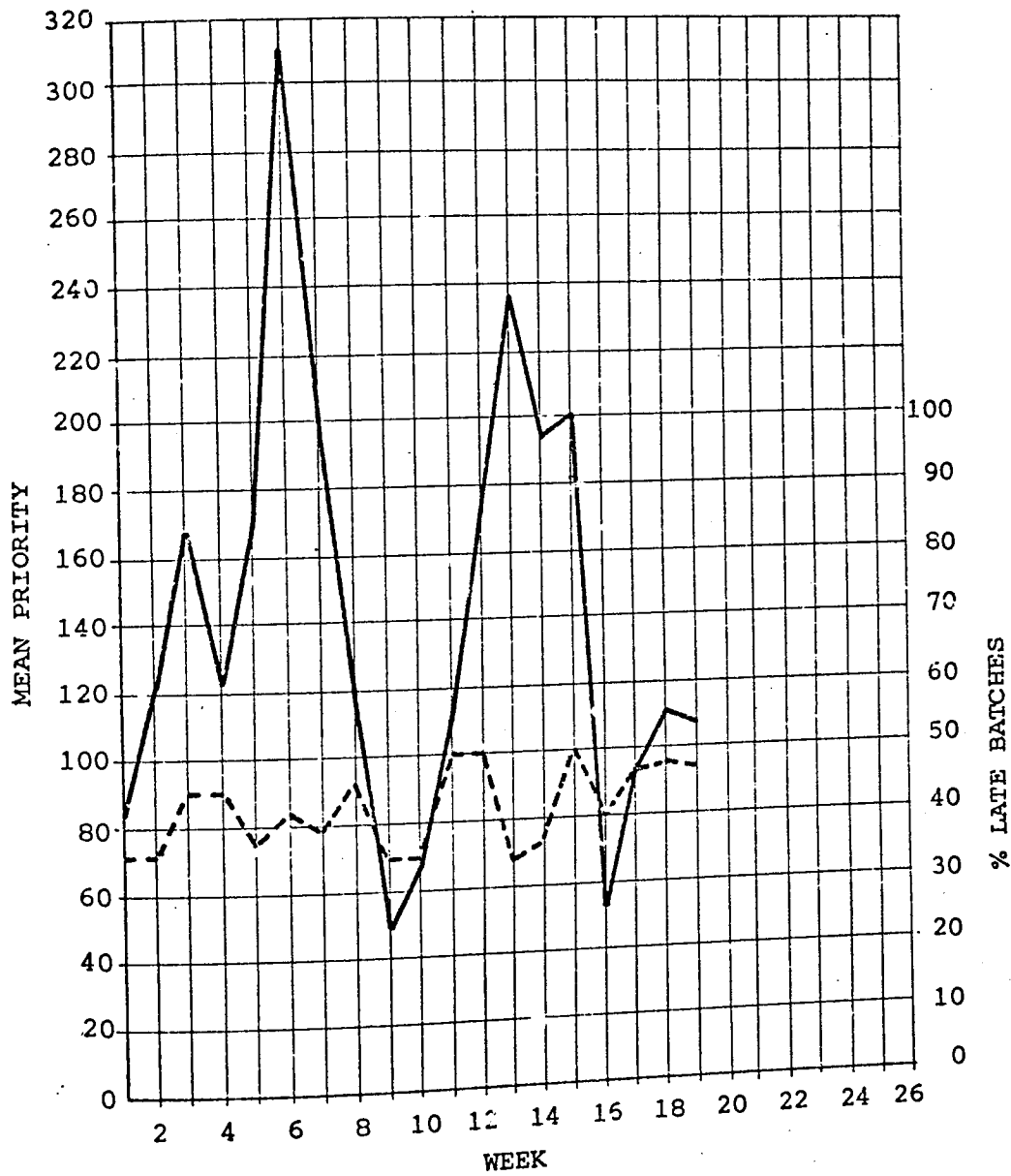

WORKS ORDER DELAY PATTERN

MACHINE NUMBER 000915

FIGURE 27

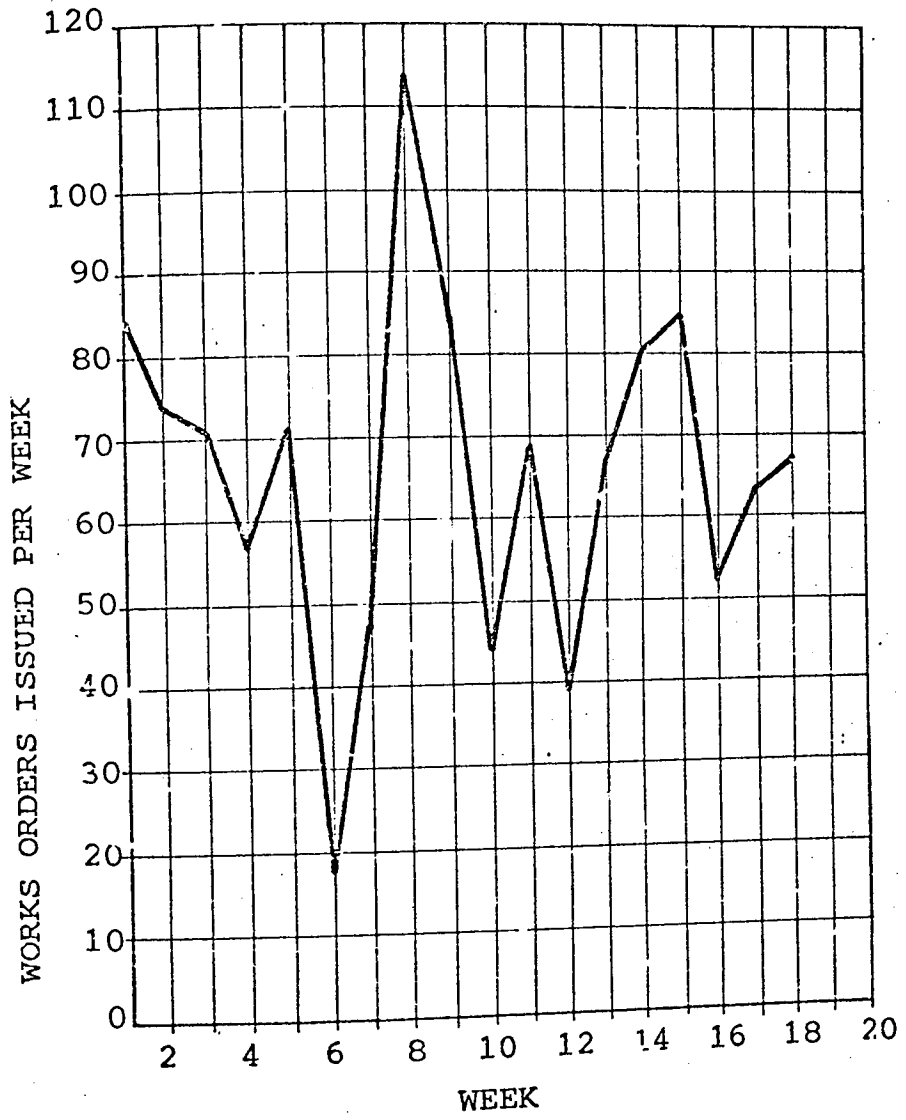

WORKS ORDER ISSUE PATTERN - TOTAL PLANT

FIGURE 28

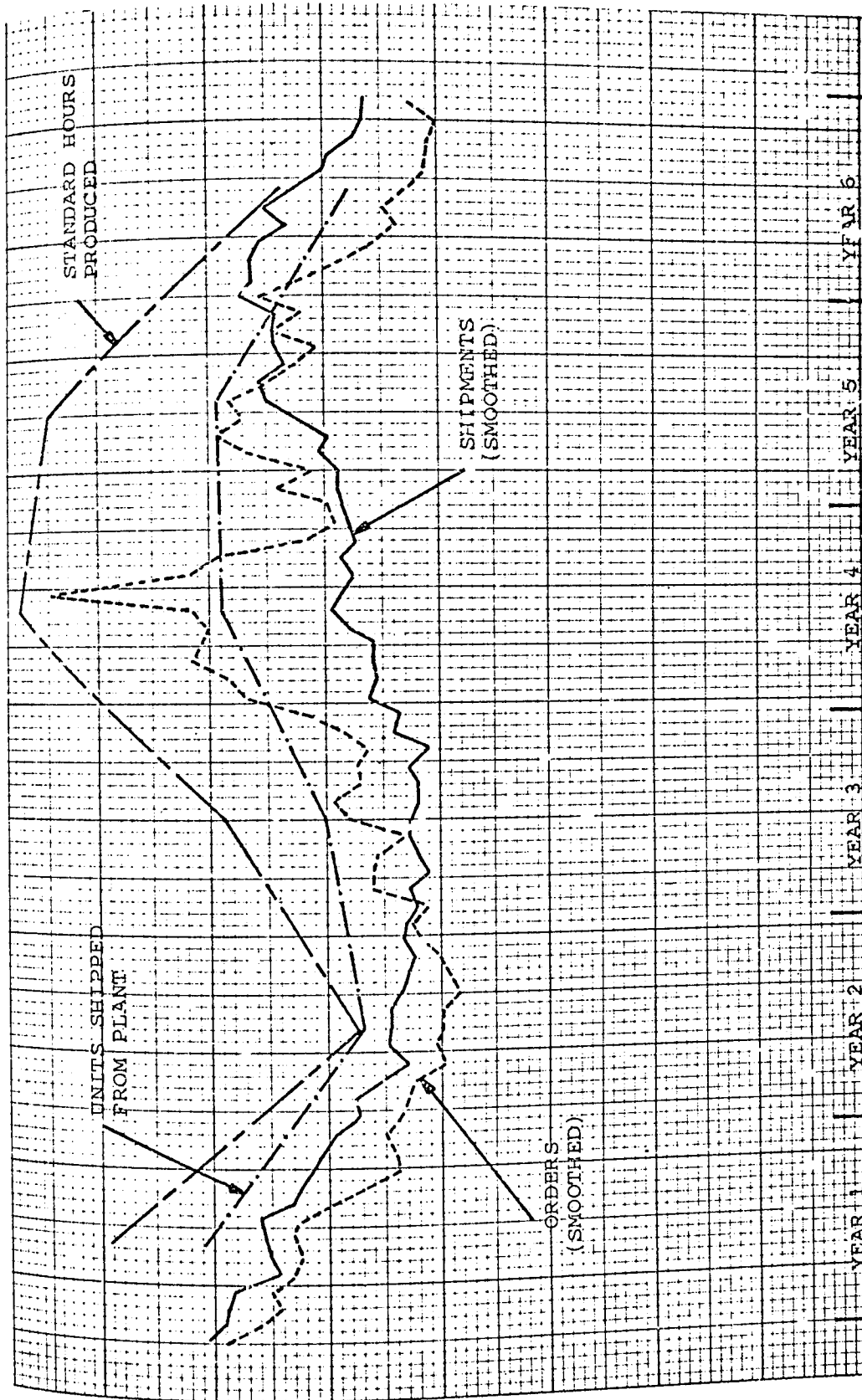

CUSTOMER DEMAND AMPLIFICATION

FIGURE 29

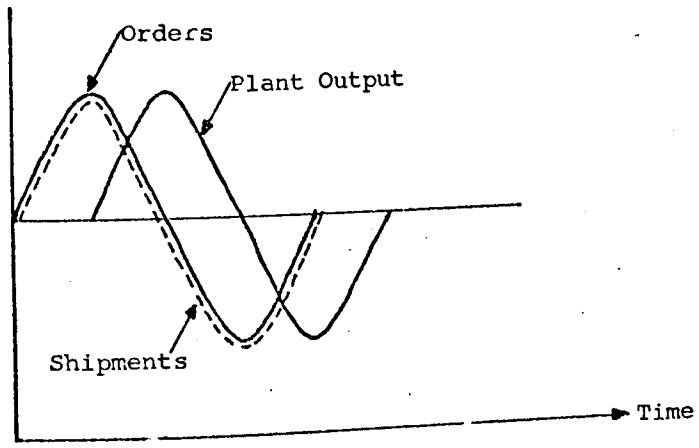
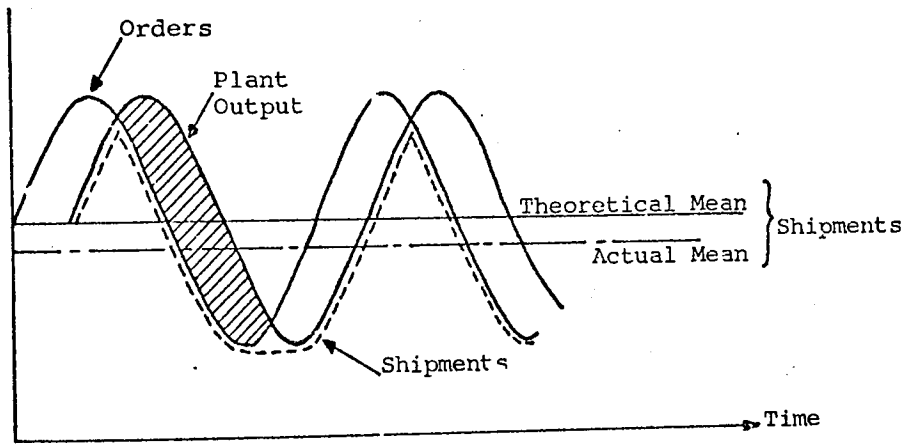
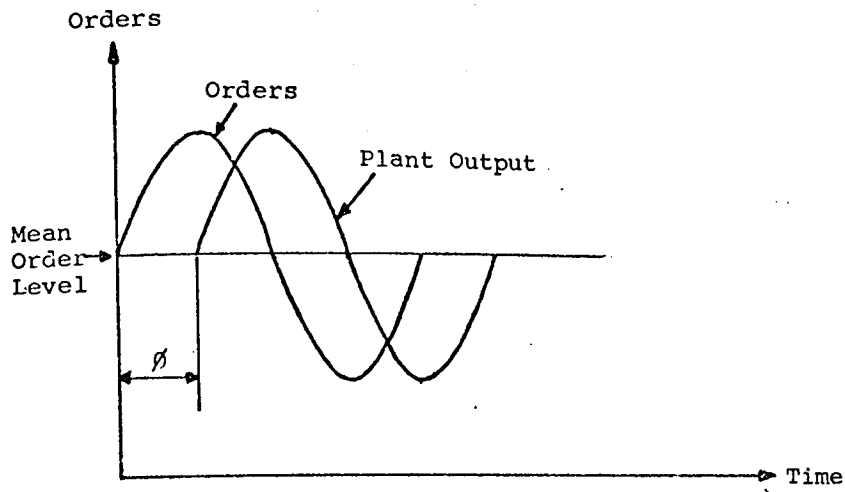

SINUSOIDAL ORDER INTAKE

FIGURE 30

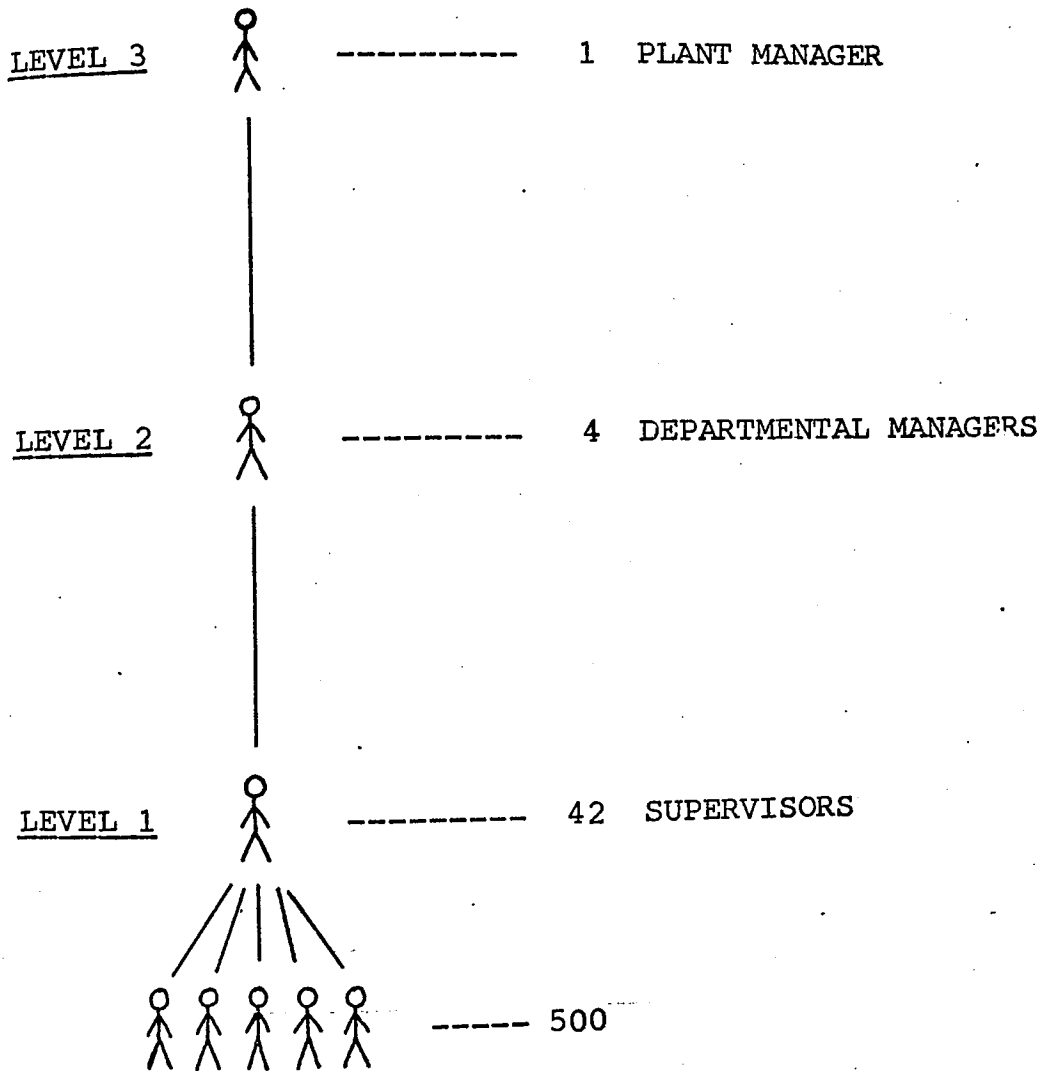

HIERARCHICAL MANAGEMENT STRUCTURE

FIGURE 31

CHIEF EXECUTIVE

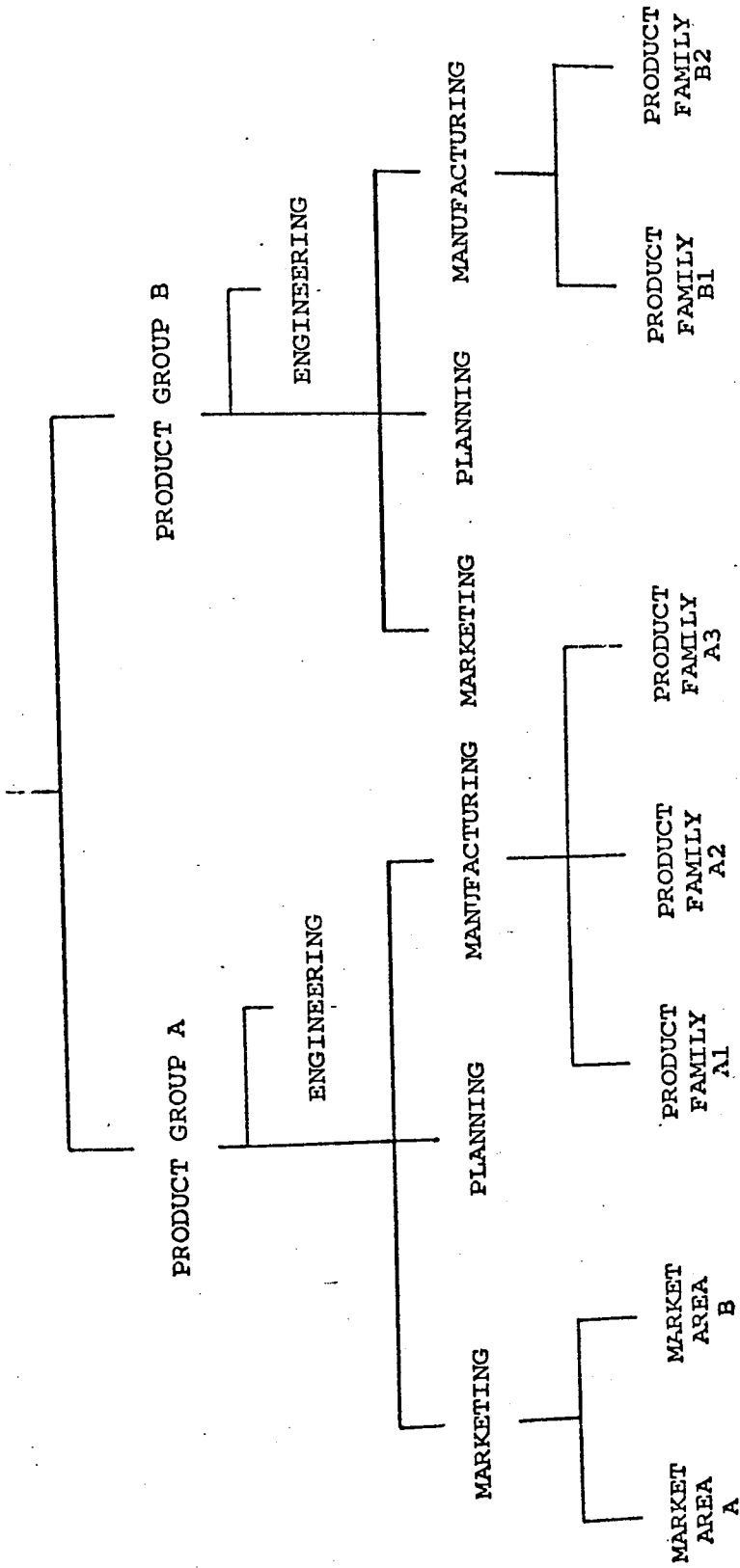

FEDERAL BUSINESS ORGANISATION

FIGURE 32

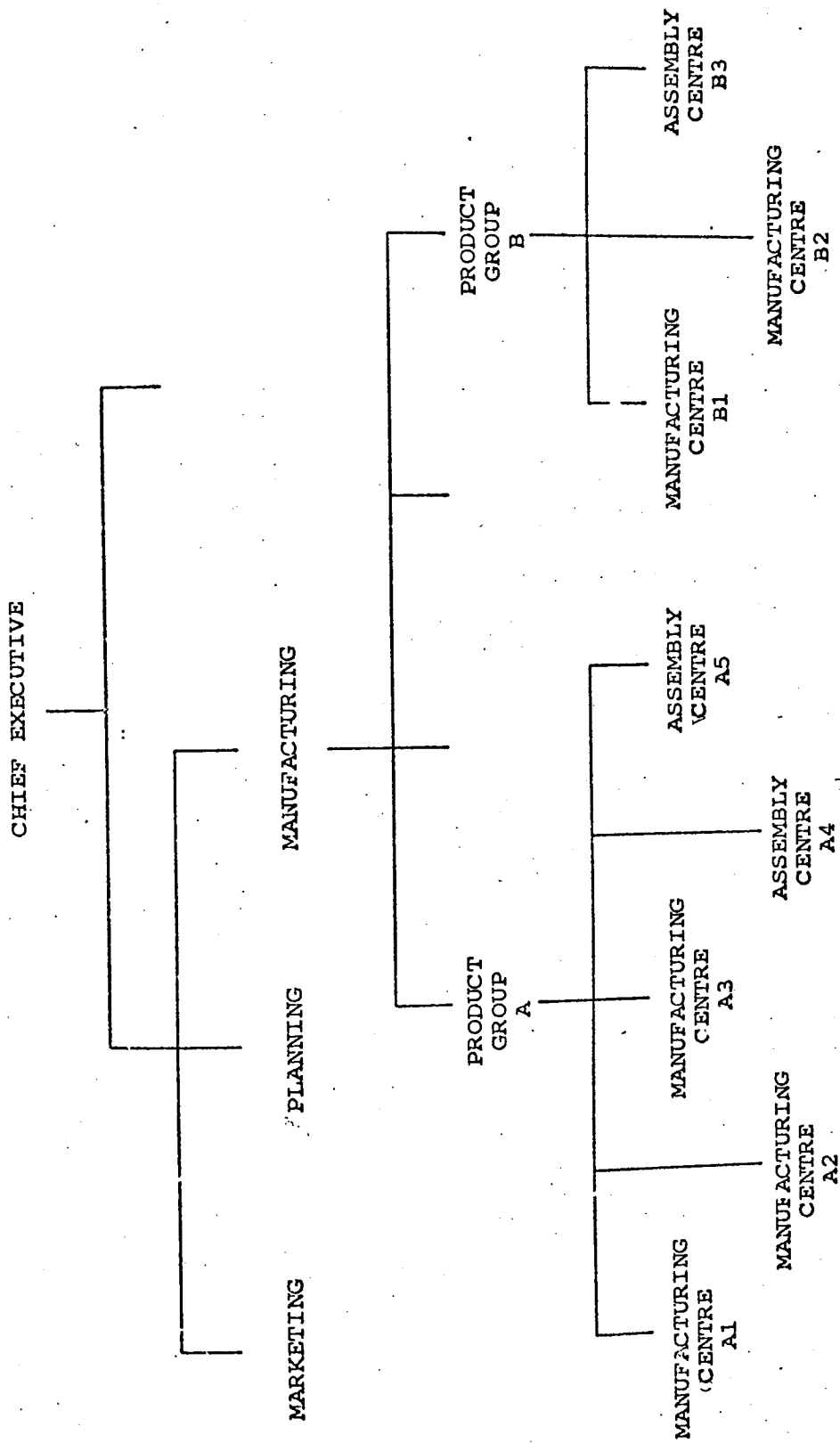

FEDERAL MANUFACTURING ORGANISATION

FIGURE 33



Aston University

Content has been removed for copyright reasons

(DAILY MIRROR)

FIGURE 34 --

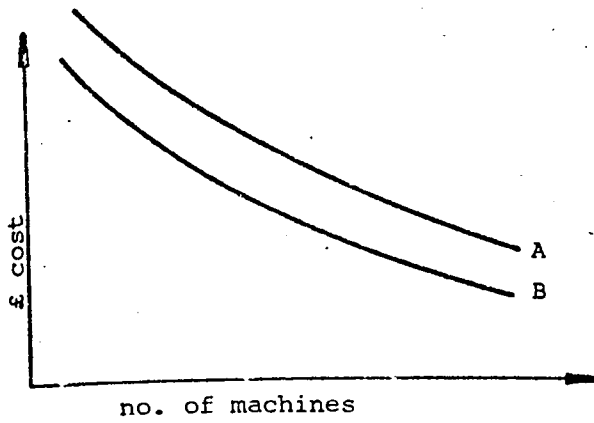

A - Machine waiting cost
 B - Work-in-progress cost

FIGURE 35(a)

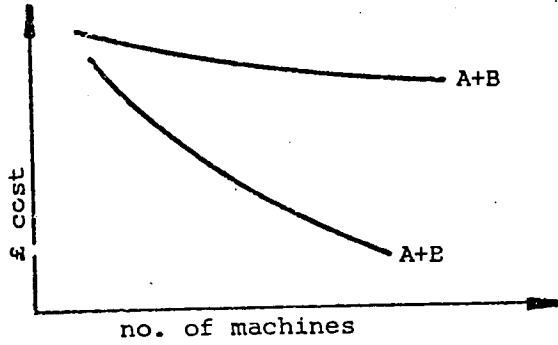

FIGURE 35(b)

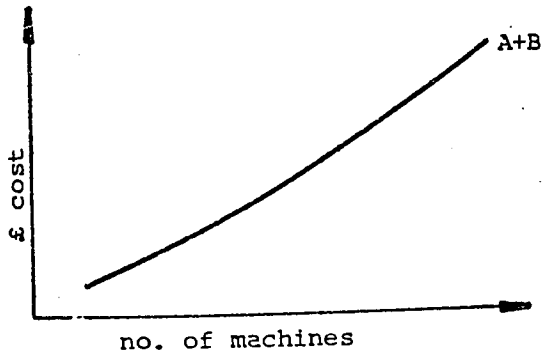

FIGURE 35(c)

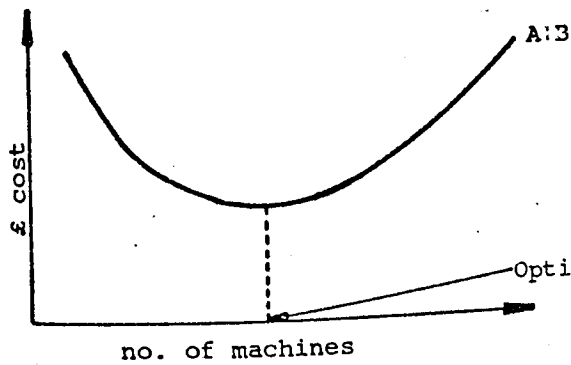
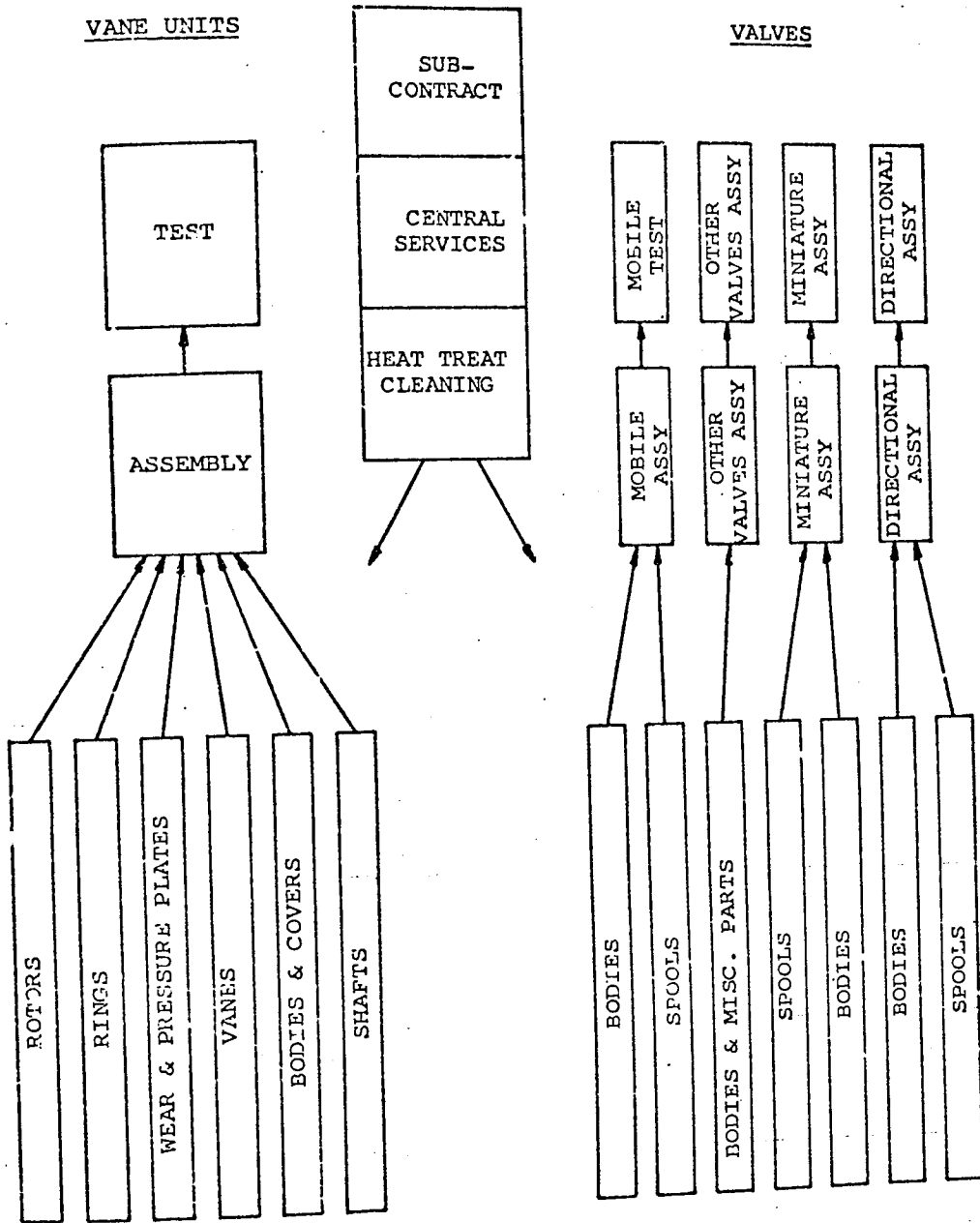

FIGURE 35(d)
 Optimum size/manageability balance

MANUFACTURING COST/MACHINE AVAILABILITY

RELATIONSHIPS

FIGURE 35



PRODUCTION FLOW PATTERN

FIGURE 36

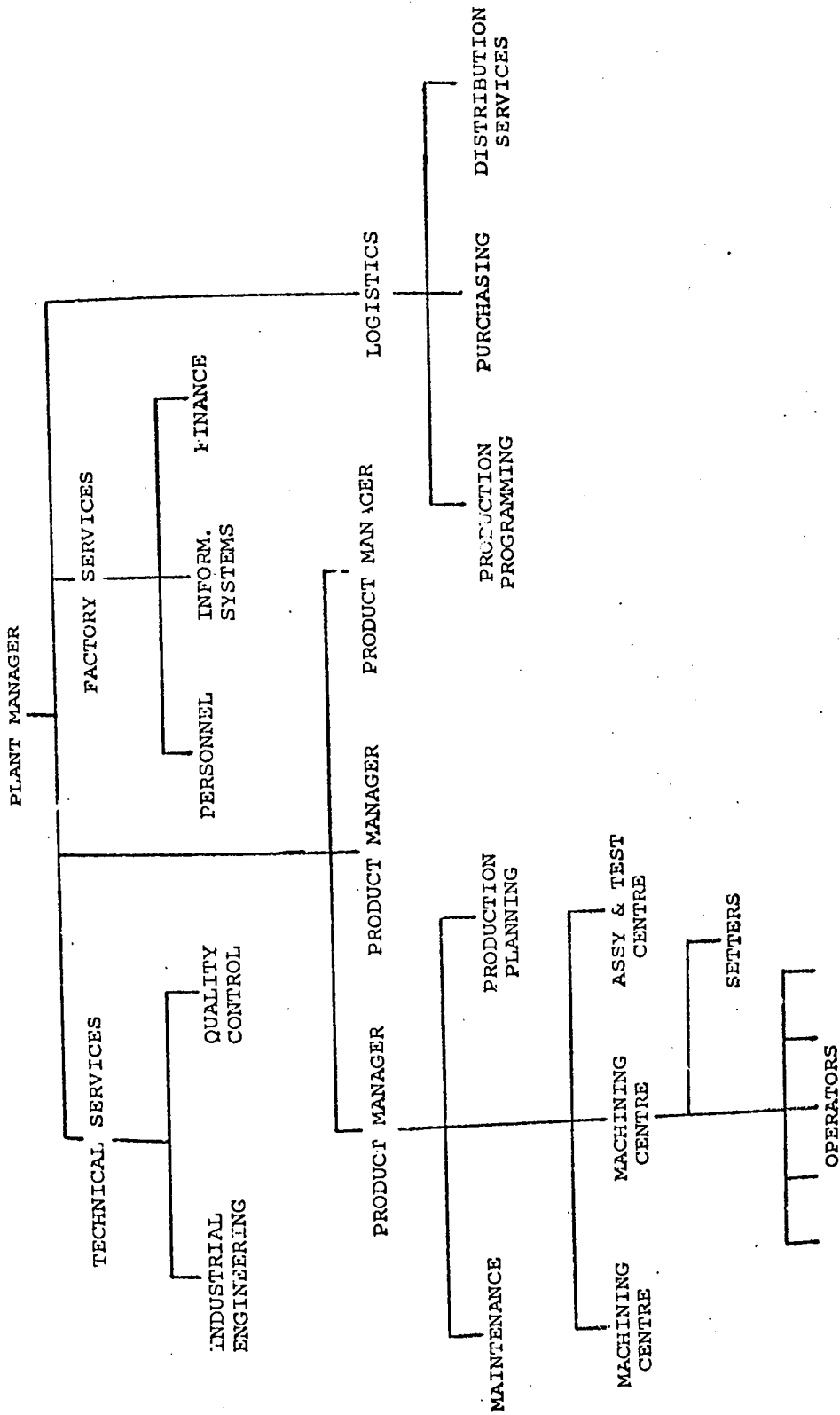

PLANT ORGANISATION STRUCTURE

FIGURE 37

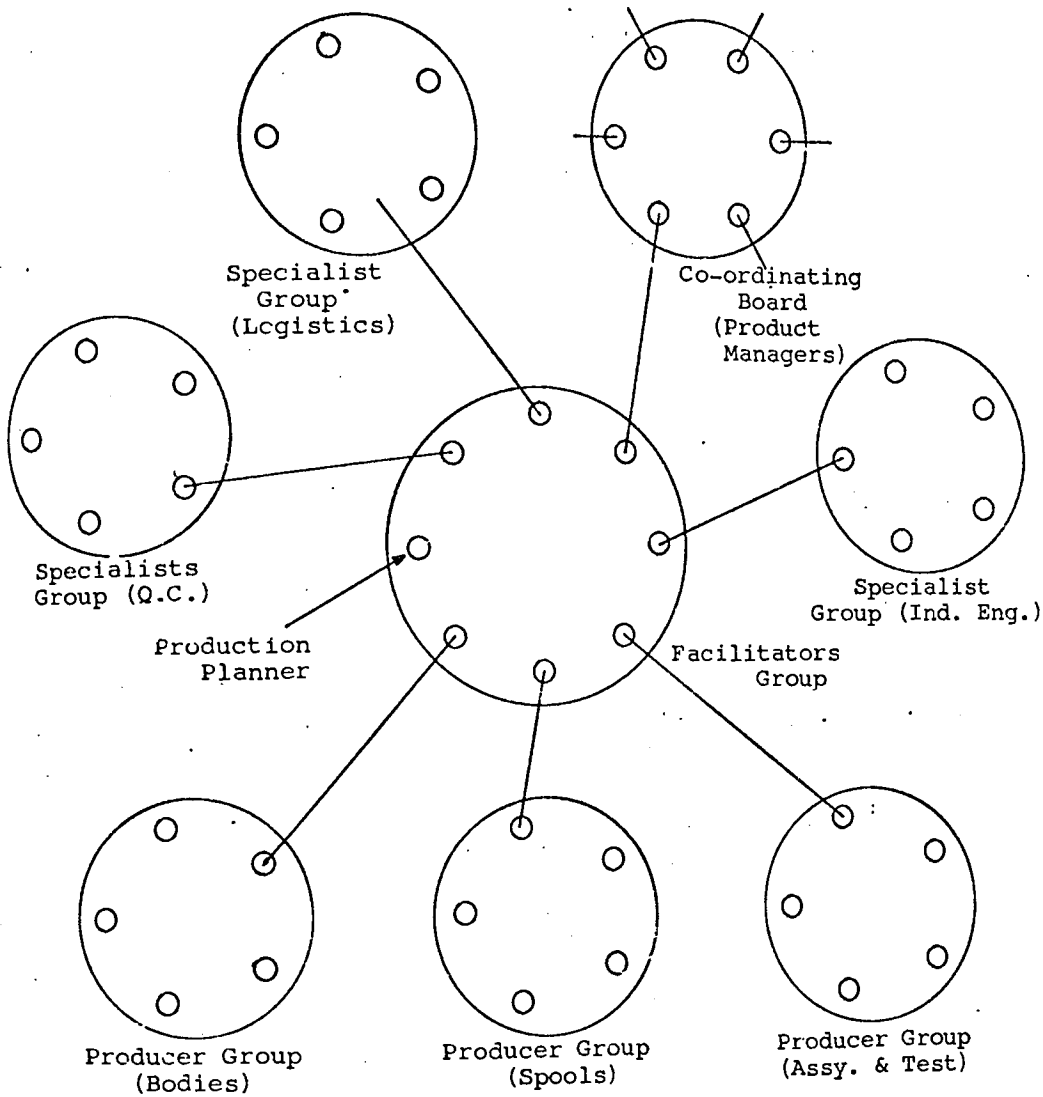

PRODUCT CENTRE MANAGEMENT STRUCTURE

FIGURE 38

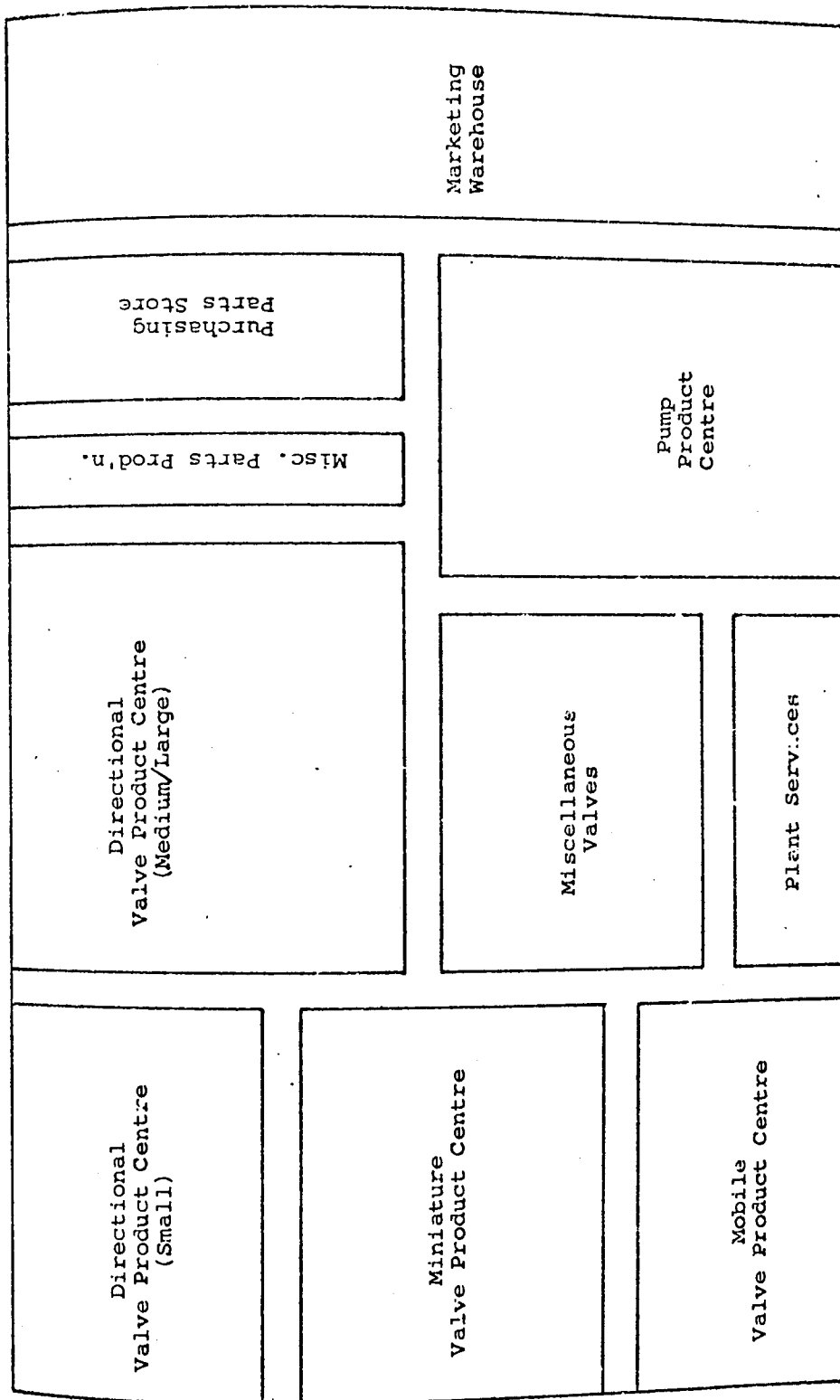

PLANT LAYOUT BLOCK DIAGRAM

FIGURE 39

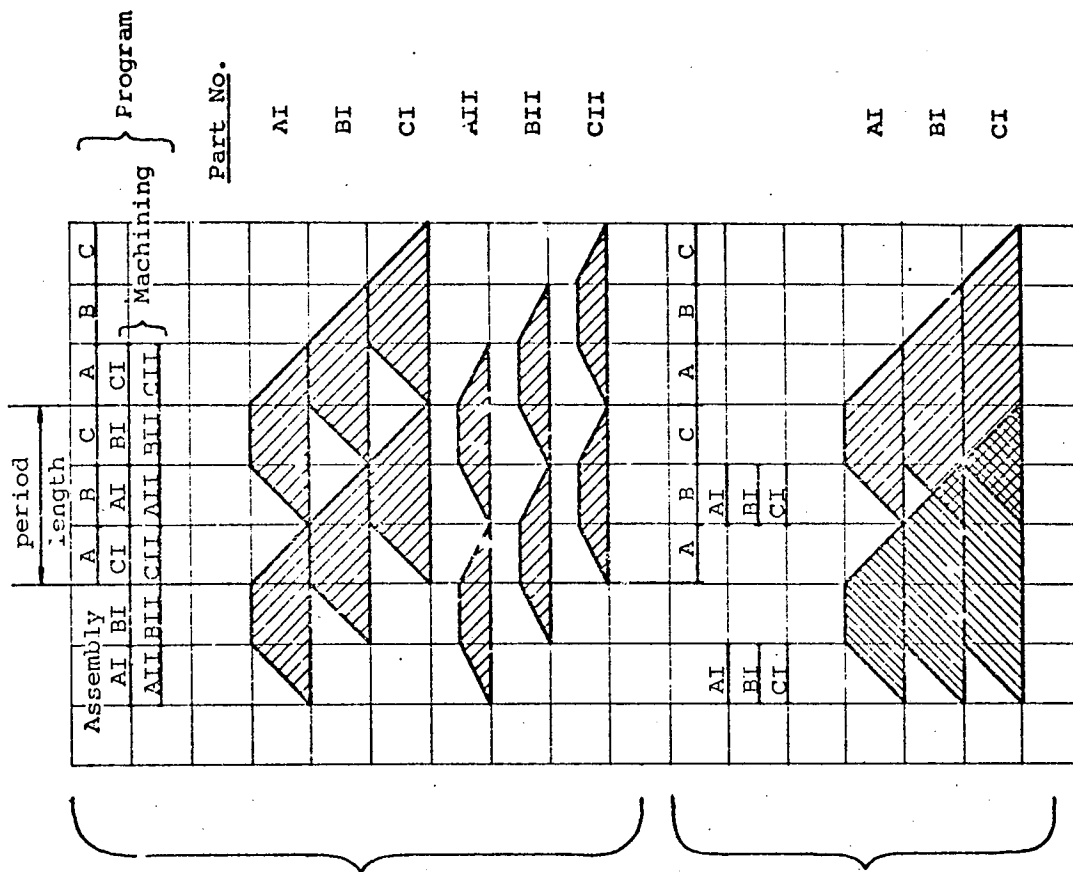

a) Linked machining and assembly programming

b) Machining and assembly no linked (Part I shown only)

STOCK LEVELS IN LINKED MACHING/ASSEMBLY PROGRAMMES

FIGURE 40

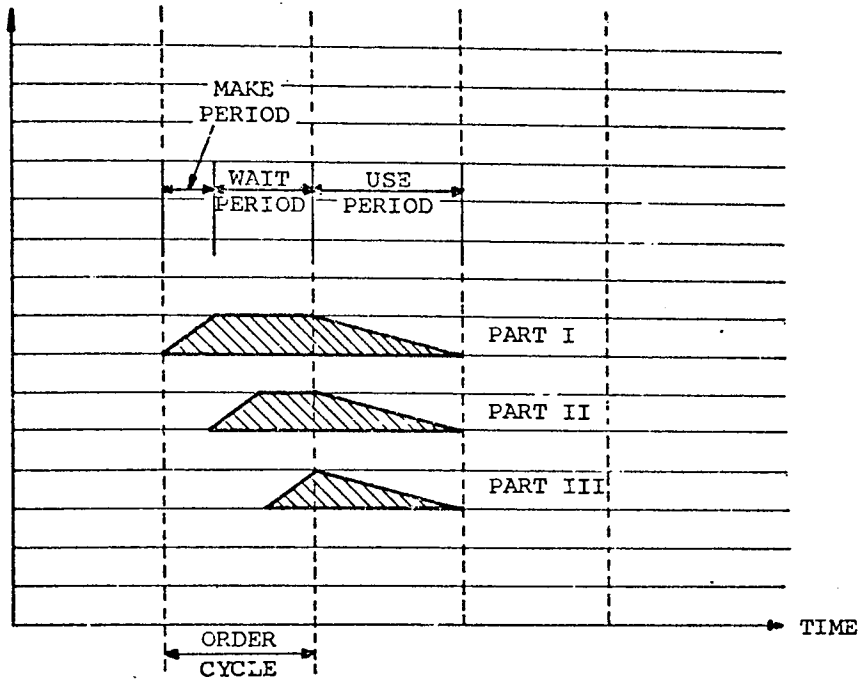

FIGURE 41(a)

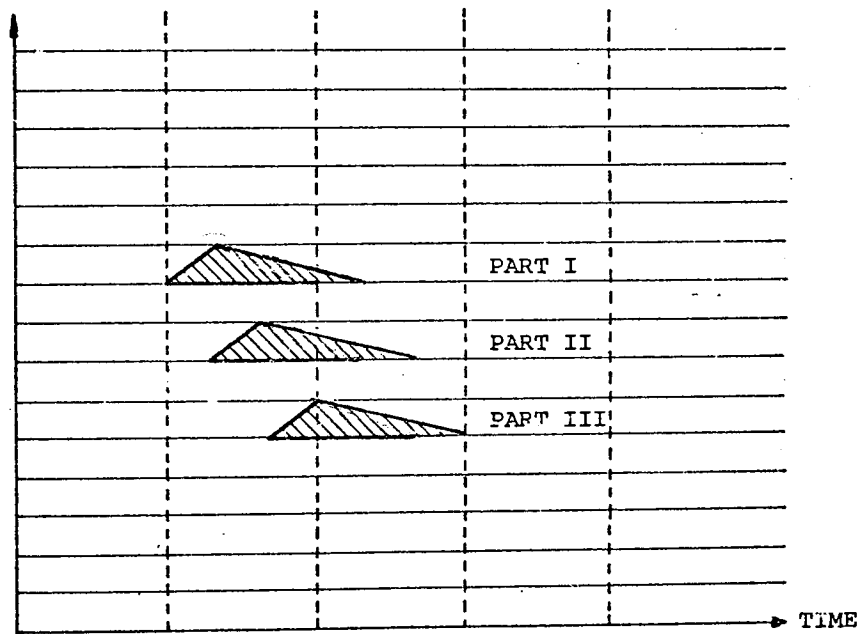
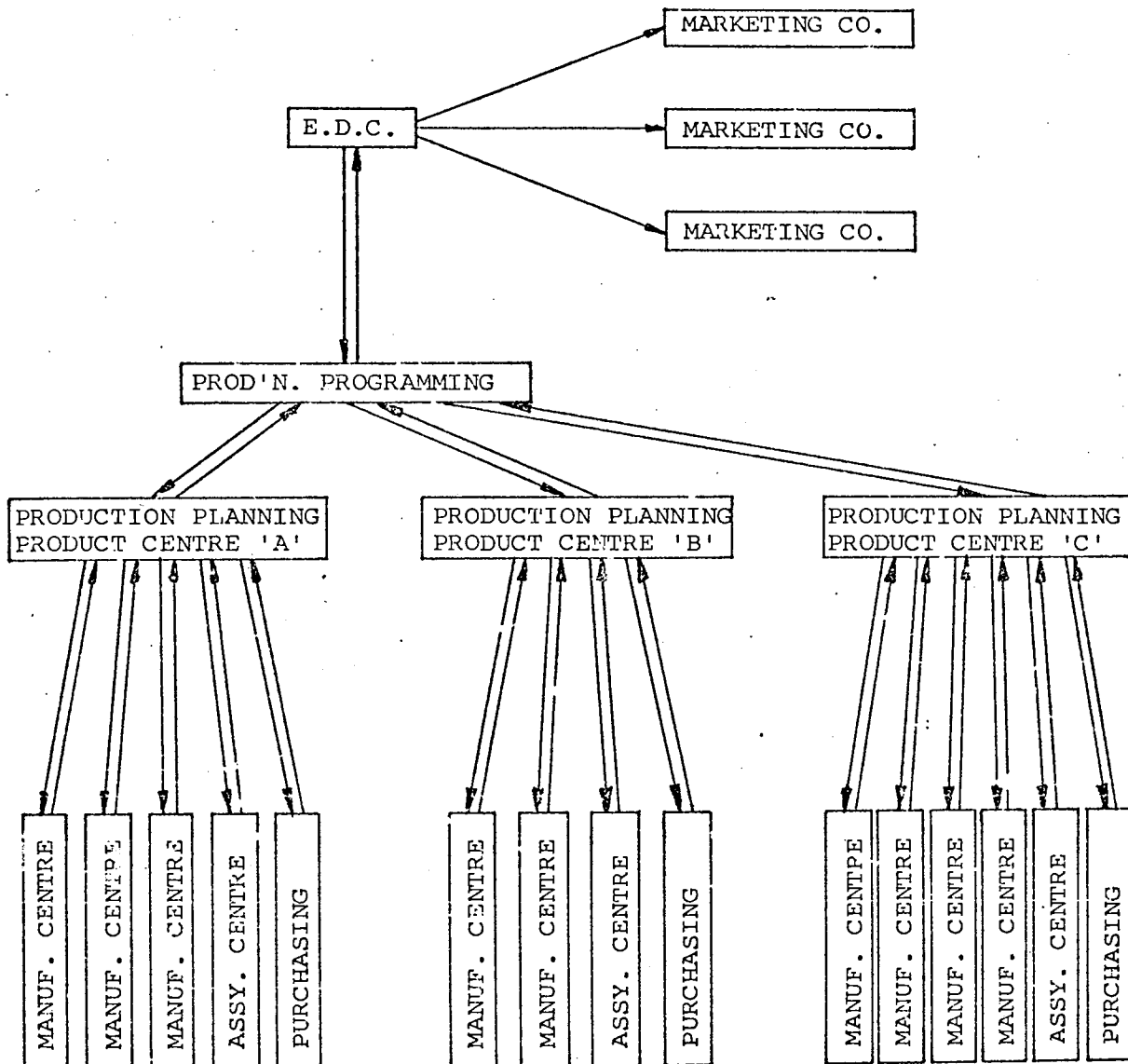
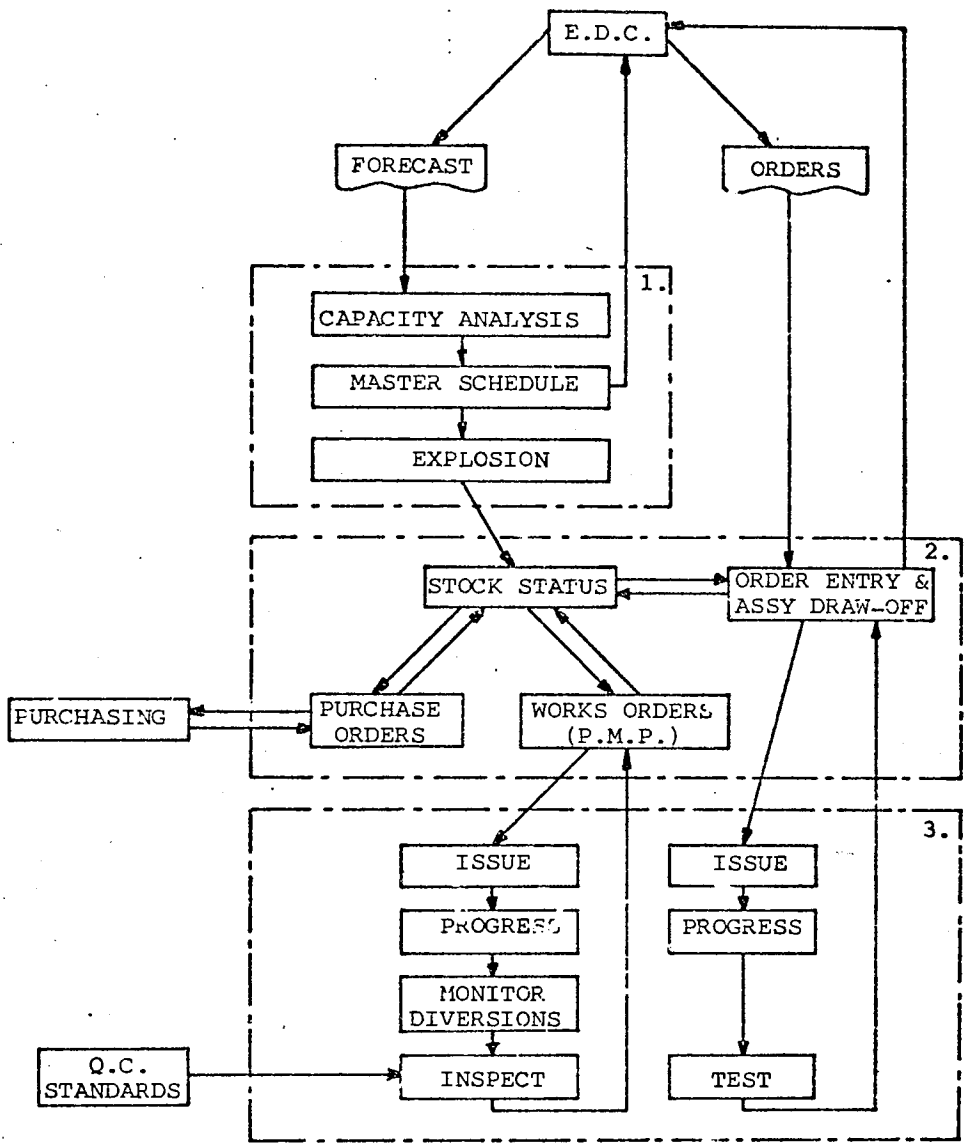

FIGURE 41(b)

LINKING MACHINING AND ASSEMBLY



MATERIAL CONTROL SYSTEM
HIERARCHIAL STRUCTURE



1. PRODUCTION PROGRAMMING
2. PRODUCTION PLANNING
3. PRODUCTION CONTROL

MATERIAL CONTROL SYSTEM - BLOCK DIAGRAM

FIGURE 43

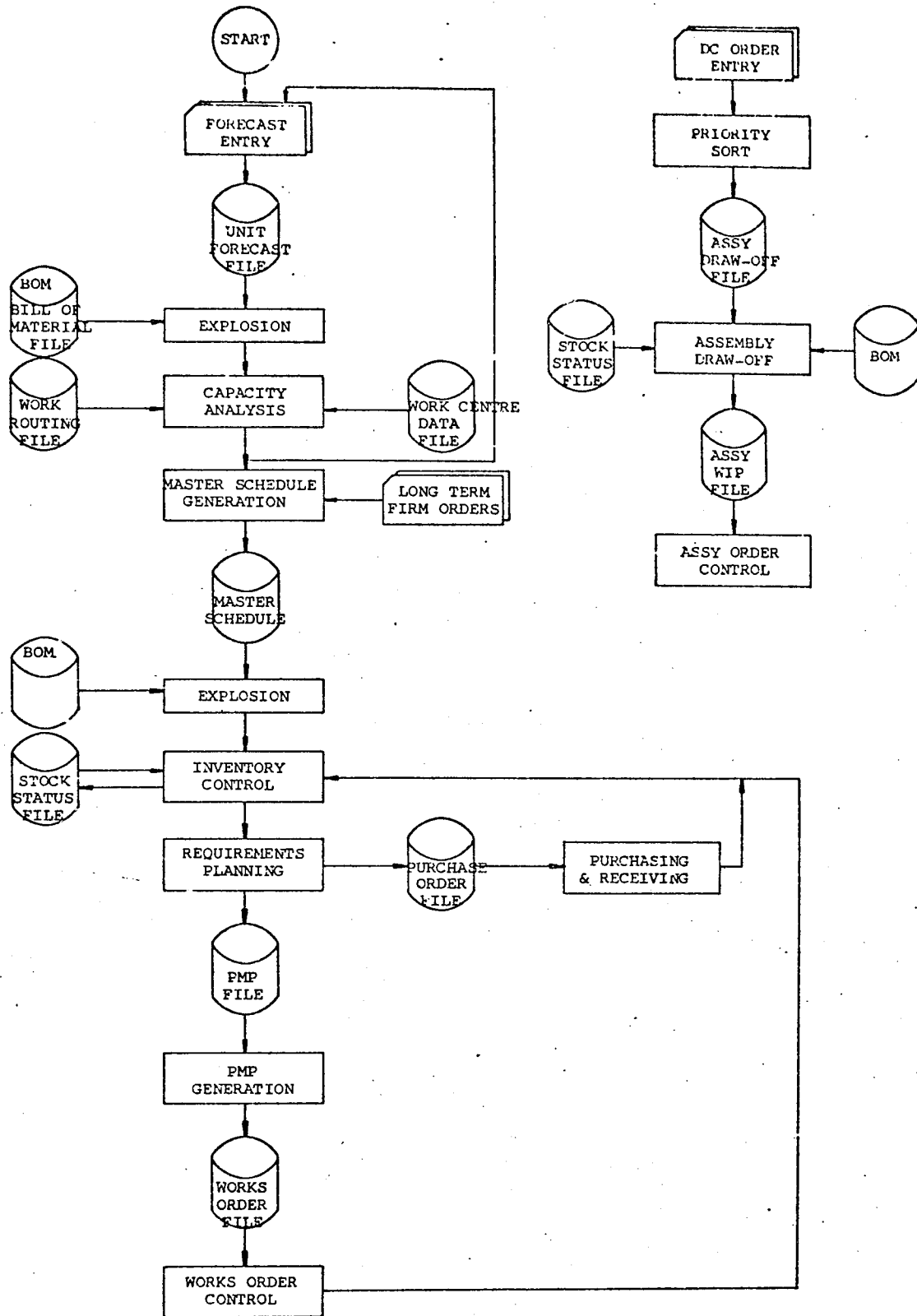

SYSTEMS OVERVIEW

FIGURE 44

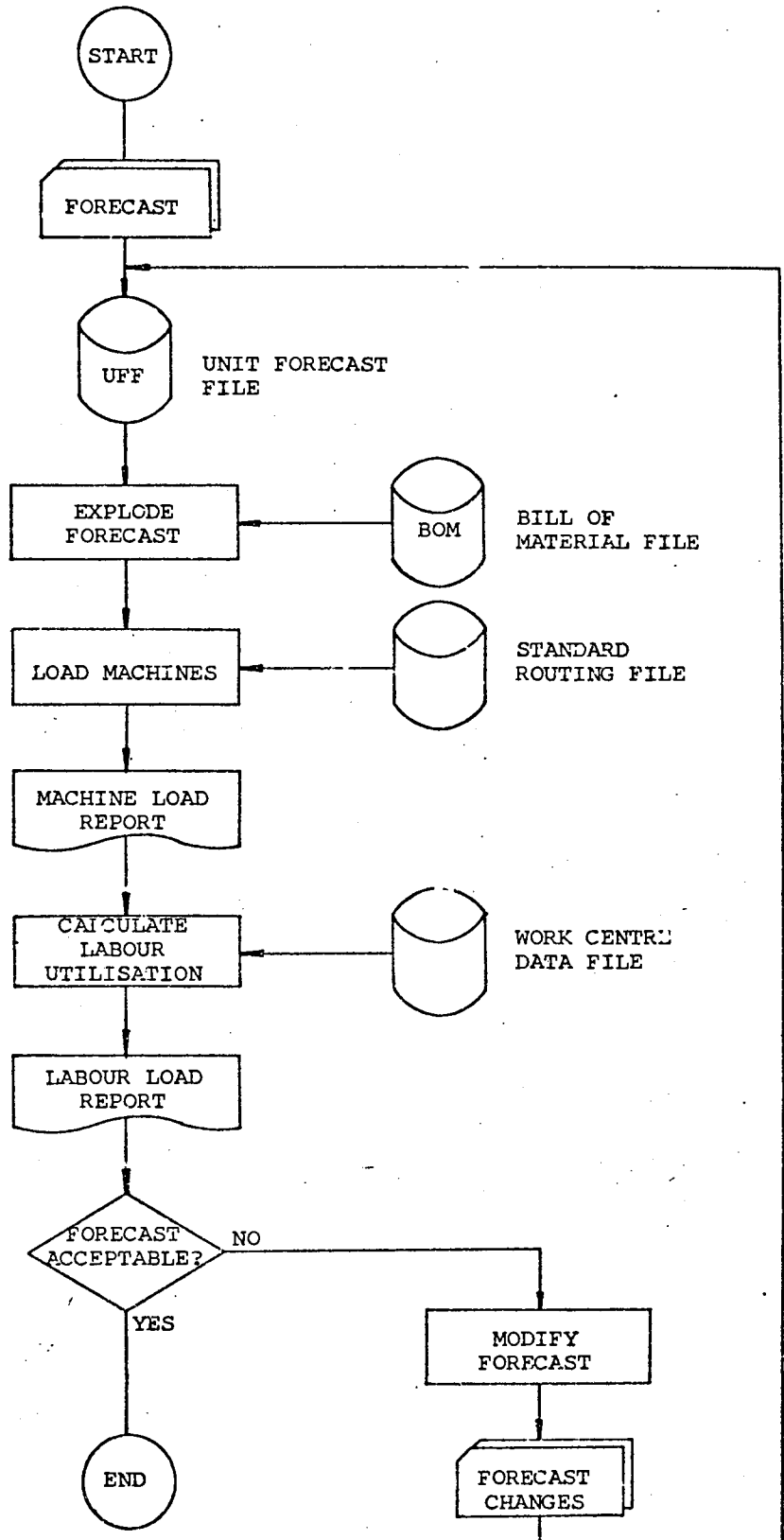

CAPACITY MATCHED FORECAST FILE GENERATION

FIGURE 45

LABOUR LOAD REPORT

PRODUCT CENTRE

MACHINE	BWS HRS	HRS/OPERATOR/ PERIOD	NO. OF OPERATORS REQ'D	OPERATORS AVAIL
.....				
.....				
.....				
.....				
.....				
.....				
TOTAL			_____	_____
			=====	=====

LABOUR LOAD REPORT

FIGURE 47

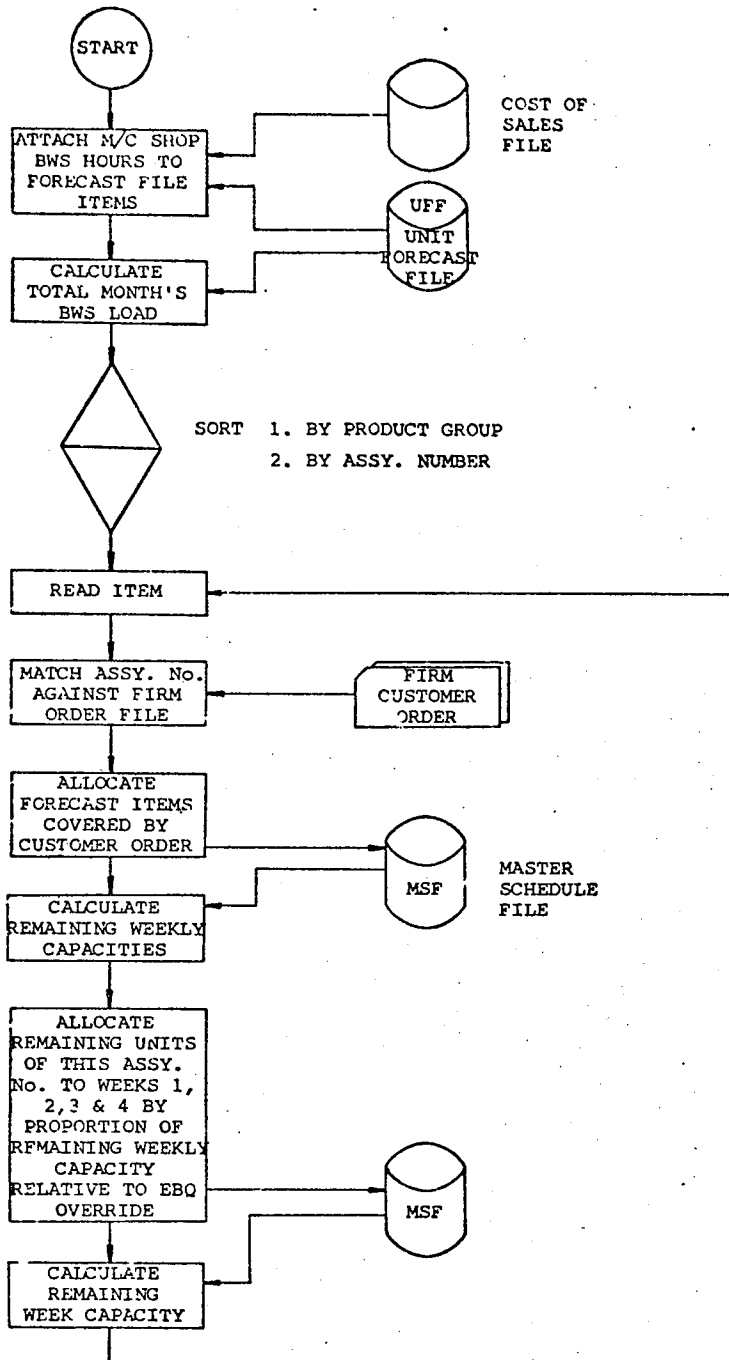

MASTER SCHEDULE GENERATION

FIGURE 48

PART USAGE		JAN	FEB	MARCH	APRIL	MAY	JUNE	JULY
PART	UI	3-	18	193	278	284	395	30
E.L.O.	89 CM	510	20					
LEAD TIME	432 P1	507		193	278	284	395	30
MINIMUM	102 P2		333	170	300	380	100	
L/A DATE	424 P3		50-	243-	521-	805-	1200-	123J-
	503 P4		283	260	282	378	83	53
	125 P6		18	193	292	293	398	30
	766 P6		510	20				
	4348 TY		507	38	193	292	398	30
	7212 LY		12-	50-	535-	828-	1225-	1256-
	495							

SHORTAGE EXPEDITE RESCHED. IN

PART USAGE		JAN	FEB	MARCH	APRIL	MAY	JUNE	JULY
PART	UI	36-	876	3184	2828	3864	3564	288
E.L.O.	756 CM	6840 P1	240	240				
LEAD TIME	1848 P2	1116		3384	2928	3164	3564	288
MINIMUM	1018 P3			4000	4000	4000	4000	
L/A DATE	3468 P4		38	3296-	6224-	10088-	13652-	13940-
	564 P5		11634	7134	8206	8342	8778	8490
	8400 P6		36-	3144	4128	4884	4680	288
	27540 TY		36-	3144	4128	4884	4680	288
	38844 LY							
	1158							

SHORTAGE EXPEDITE RESCHED. IN

PART USAGE		JAN	FEB	MARCH	APRIL	MAY	JUNE	JULY
PART	UI	46	20	230	181	246	250	24
E.L.O.	72 CM	418 P1	66	230	181	246	250	24
LEAD TIME	70 P2		280	245	245	250	100	
MINIMUM	92 P3		104	126-	307-	553-	803-	827-
L/A DATE	235 P4		384	154	218	222	72	48
	320 P6		61	230	281	336	350	24
	633 P6		20					
	2654 TY		81	230	281	336	350	24
	5080 LY		89	141-	422-	758-	1108-	1132-
	170							

SHORTAGE EXPEDITE RESCHED. IN

Part No.:

Standard Data

.....
.....
.....
.....

WEEK	1	2
PF		
SF		
TF		
O		
B		

BIN:

WEEK	1	2	3	4
ADO				
O				
BS				

WEEK	16	17
PF		
SF		
TF		
O		
B		

STOCK STATUS REPORT FORMAT

FIGURE 50

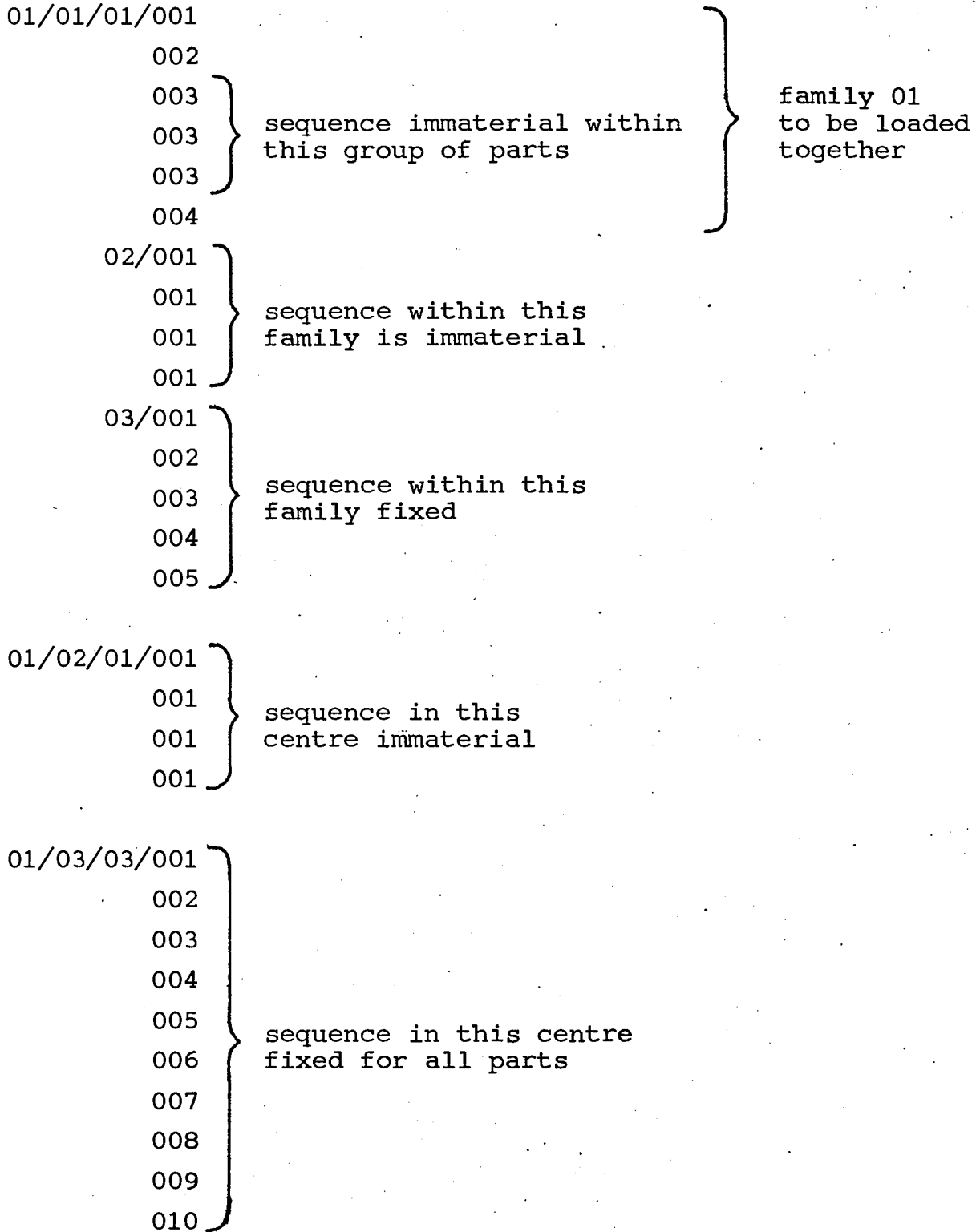

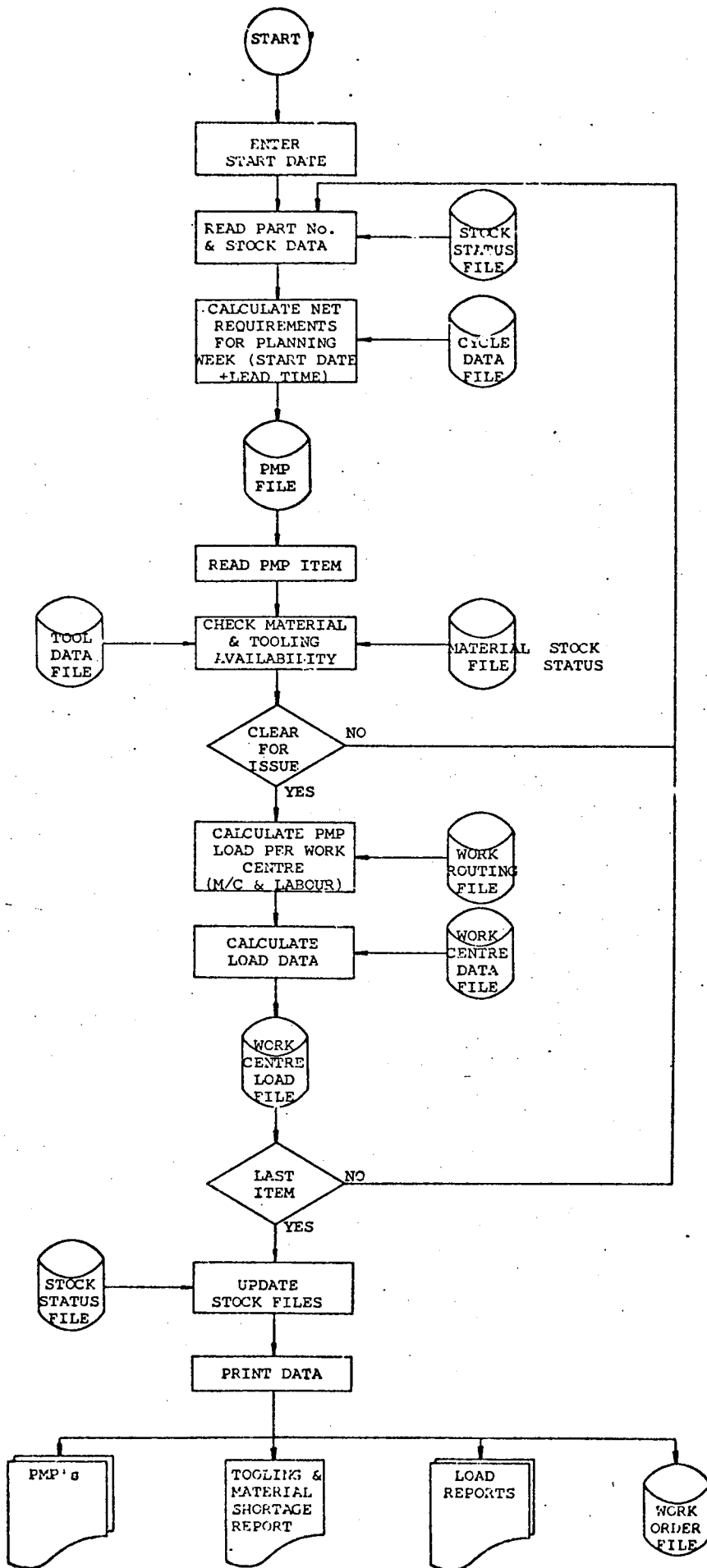

PERIOD MACHINING PROGRAMME GENERATION

FIGURE 53

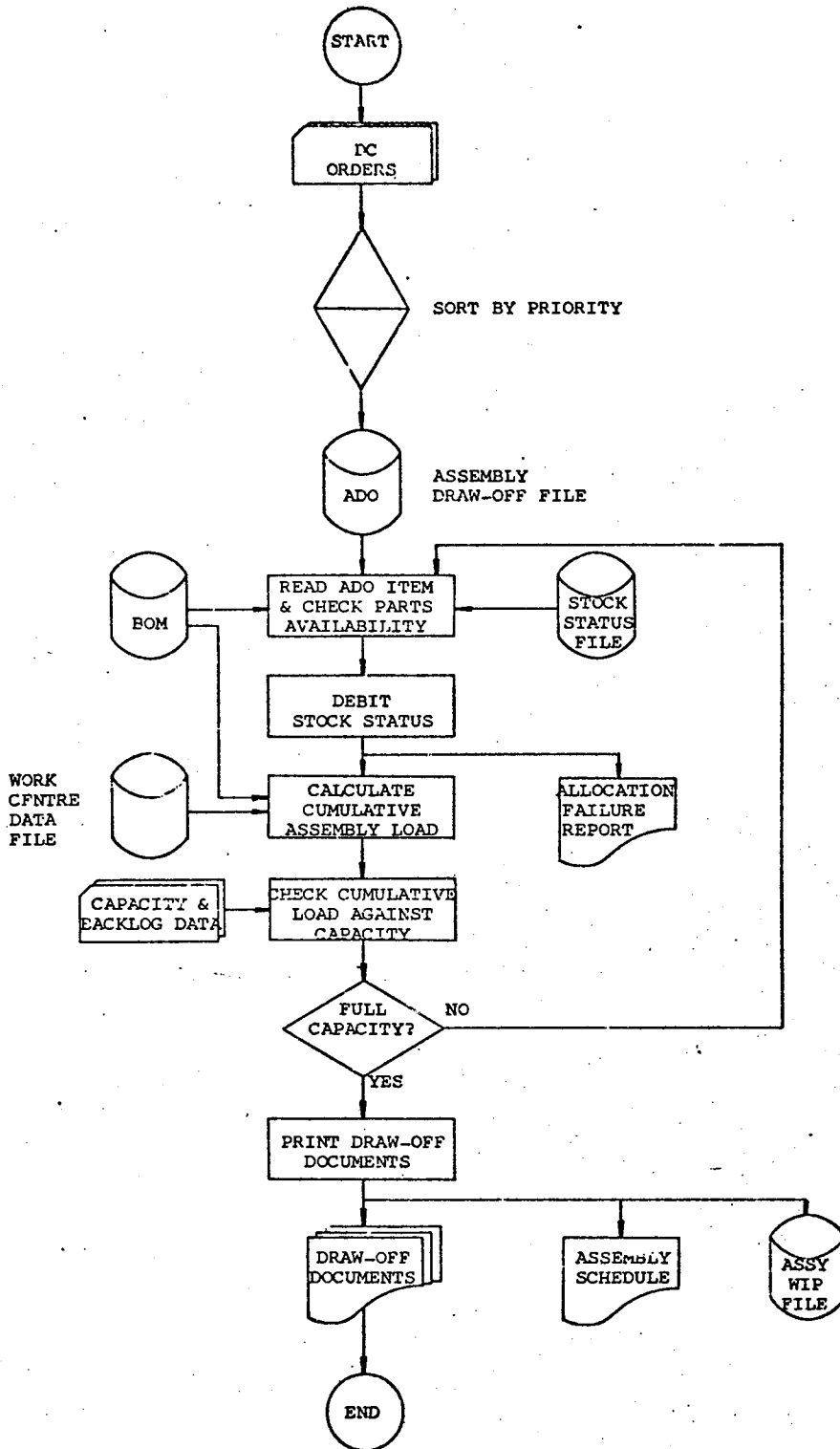

ASSEMBLY DRAW-OFF

FIGURE 54

G T. PILOT CENTRE - SVH
WEAR & PRESSURE PLATES

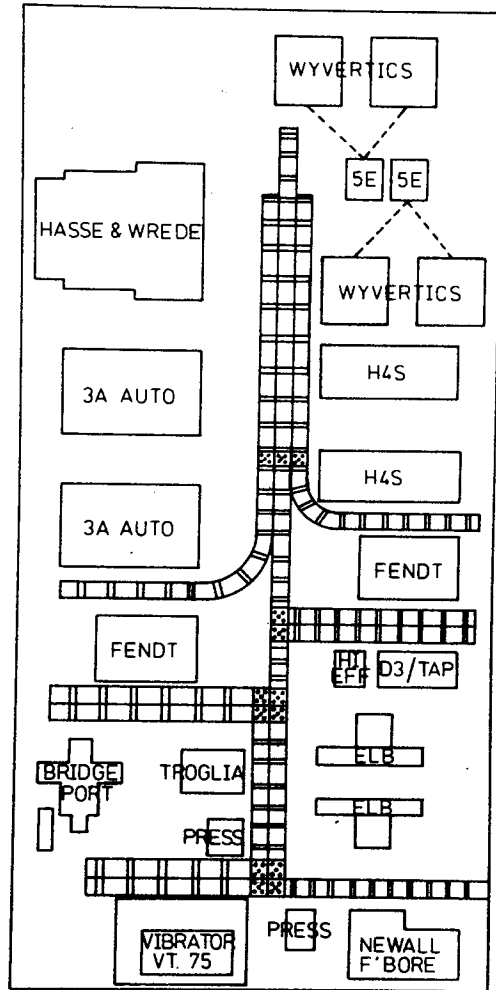

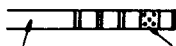

 ROLLER TRACK BALL TABLE

PILOT CELL LAY-OUT

FIGURE 56

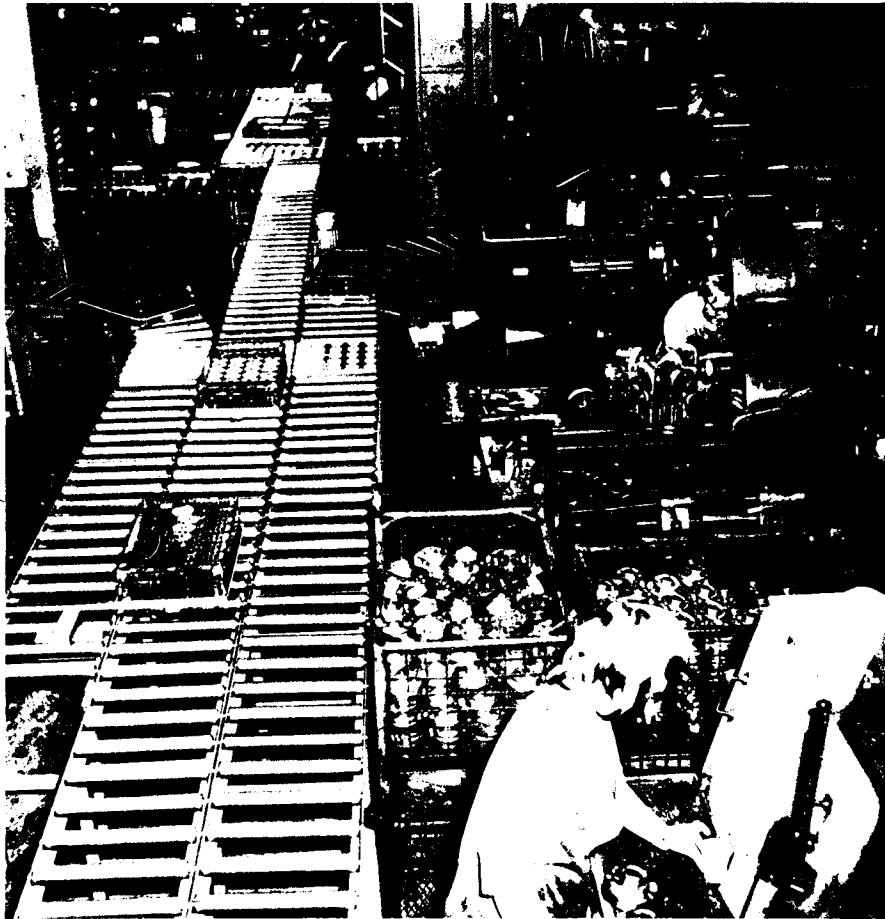

VIEW OF PILOT CELL

FIGURE 57



VIEW OF PILOT CELL

FIGURE 58

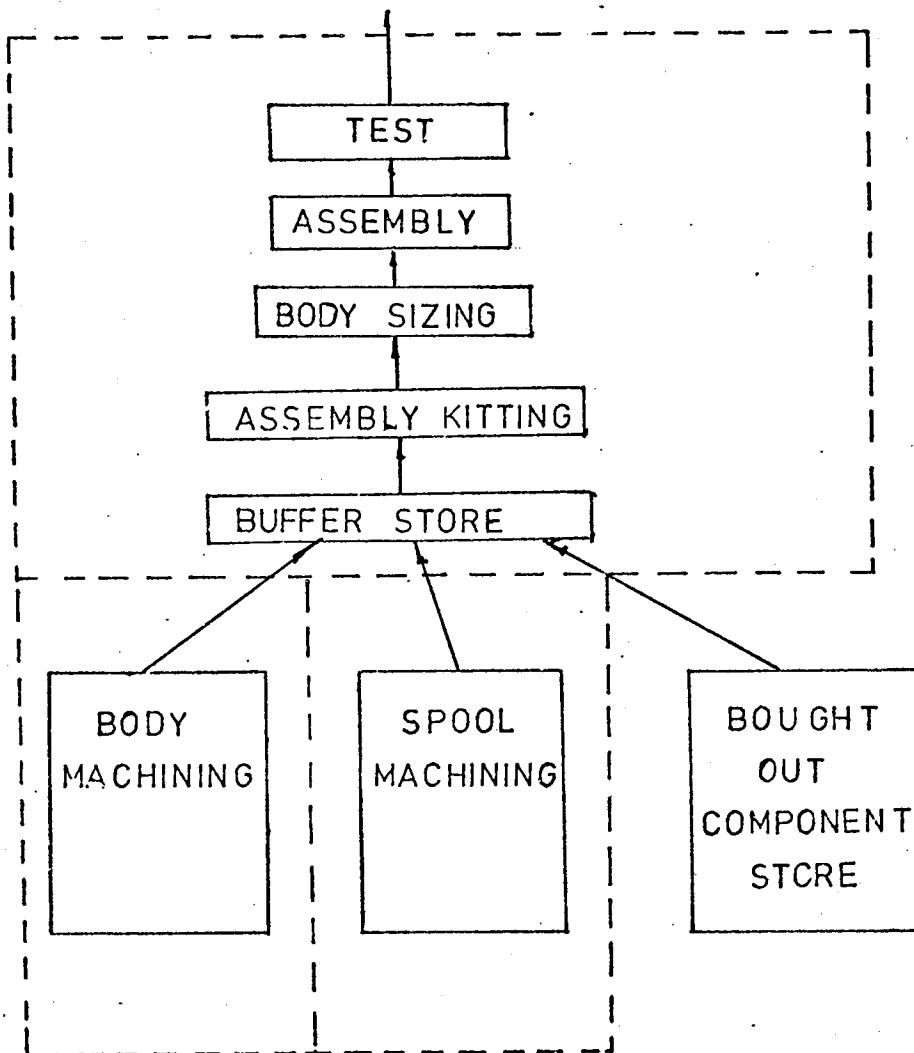

PRODUCT CENTRE SCHEMATIC

FIGURE 59

CYCLE CALENDAR		CENTRE:				
Month		January		February		
Period		1	2	3	4	
Start Date		1.1.77	15.1.77	29.1.77	13.2.77	
Part No.						
1234	Due in				X	
	PMP start		4			
	Due in					
	PMP start					
	Due in					
	PMP start					

CYCLE CALENDAR

FIGURE 61

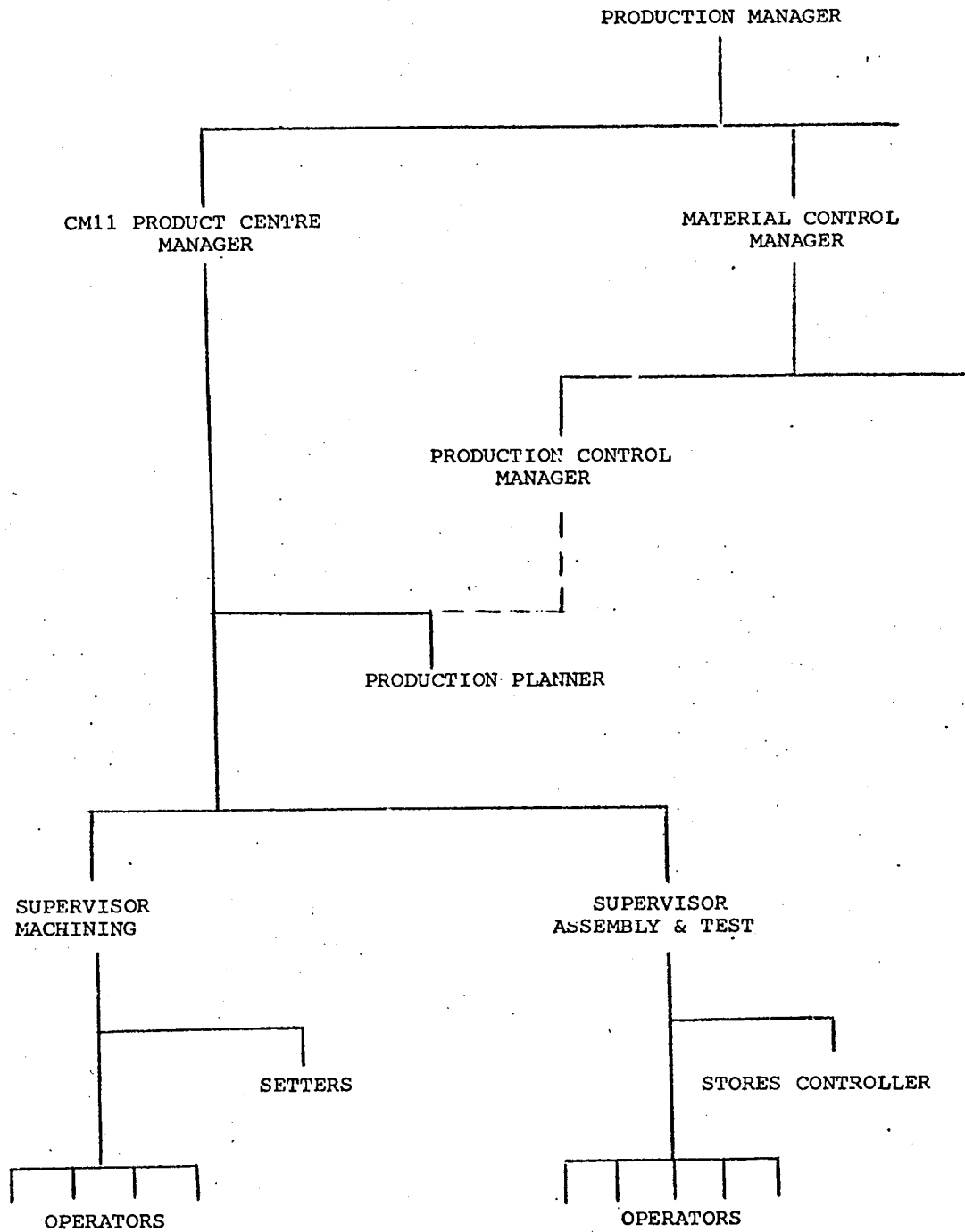

PRODUCT CENTRE ORGANISATION CHART

FIGURE 62