

Some pages of this thesis may have been removed for copyright restrictions.

If you have discovered material in AURA which is unlawful e.g. breaches copyright, (either yours or that of a third party) or any other law, including but not limited to those relating to patent, trademark, confidentiality, data protection, obscenity, defamation, libel, then please read our [Takedown Policy](#) and [contact the service](#) immediately

STRATEGIES FOR LOCAL DRUG DELIVERY TARGETING THE OESOPHAGUS

LIANG ZHANG

Doctor of Philosophy

ASTON UNIVERSITY

MAY 2008

This copy of the thesis has been supplied on condition that anyone who consults it is understood to recognise that its copyright rests with its author and that no quotation from the thesis and no information derived from it may be published without proper acknowledgement.

Aston University

Strategies for local drug delivery targeting the oesophagus

Liang Zhang

Doctor of Philosophy

2008

The oesophagus as a site for drug delivery has been much overlooked in comparison to the remainder of the gastro-intestinal tract. However, diseases of the oesophagus are relatively common and pharmacological therapy is restricted to systemic treatment, most usually by standard dosage forms, even though the local blood supply to this organ is poor. Localised, targeted drug delivery to the oesophagus offers the potential for more effective delivery and reduced drug dosages, coupled with increased patient compliance. This thesis considers bioadhesive liquids, orally retained tablets and films as well as chewable dosage forms as drug delivery systems to target the oesophagus. Miconazole nitrate was used as a model antifungal agent.

Chitosan and xanthan gum hydrogels were evaluated as viscous polymer vehicles with the *in vitro* retention, drug release and minimum inhibitory concentration values of the formulations measured. Xanthan showed prolonged retention on the oesophageal surface *in vitro* yet chitosan reduced the MIC value; both polymers offer potential for local targeting to the oesophagus. Cellulose derivatives were investigated within orally retained dosage forms. Both drug and polymer dissolution rates were measured to investigate the drug release mechanism and to develop a formulation with concomitant drug and polymer release to target the oesophagus with solubilised drug within a viscous media. Several *in vitro* dissolution methods were evaluated to measure drug release from chewable dosage forms with both drug and polymer dissolution quantified to investigate the effects of dissolution apparatus on drug release.

The results from this thesis show that a range of drug delivery strategies that can be used to target drug to the oesophagus. The composition of these formulations as well as the methodology used within development are crucial to best understand the formulation and predict its performance *in vivo*.

Keywords: Oesophagus, fungal infection, bioadhesion, mucoadhesive delivery system, dosage form design

Declaration

This copy of the thesis has been supplied on condition that anyone who consults it is understood to recognize that its copyright rests with its author and that no quotation from the thesis and no information derived from it may be published without proper acknowledgement.

I hereby declare that this thesis entitled 'Strategies for local drug delivery targeting the oesophagus' is not substantially the same as any that I have submitted for a degree or diploma or other qualification at any other University. I further state that no part of my thesis has already been or is being concurrently submitted for any such degree, diploma or other qualification. Except where noted in the context, this thesis is the result of my own work during my PhD study.

I hereby declare that my thesis does not exceed the limit of length prescribed in the Special Regulations of the Ph.D. examination for which I am a candidate. The length of my thesis does not exceed 80,000 words.

Signed

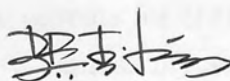

Liang Zhang

Acknowledgements

First, I would like to express my gratitude to my supervisor, Dr Hannah Batchelor, for her guidance, encouragement, patience and supervision throughout the time I worked with her. Her deep insights, knowledge and valuable suggestions make my research work always go in the right track.

I am also grateful to Dr Barbara Conway for her valuable advices and helpful comments on the paper which I have finished during my PhD study. Thanks to my collaborators and good friends, Prof Yvonne Perrie, Dr Peter Hanson, Dr Haoying Li and Mr Songjie Chen, for the interesting discussions and sharing ideas during the last couple of years.

Thanks to Mr Chris Bache for his technical support and patience in the lab. Thanks to Mr Jiteen Kansara for his friendly help and happiness taken to the lab for his technical. I would like to thank all my friends who have enriched my colorful life in Aston University. Thanks to Johanna, Xiaosong, Habib, Daniel, Sarah, Tristan and Anil.

Last but not least, I thank my parents for their endless support and encouragement. I would like to express my sincere gratitude to my husband for his love, patience, understanding and being with me in the whole life journey.

Contents

I would like to dedicate this thesis to my loving parents and husband.

1. Introduction to Transcatheter Drug Delivery	21
1.1 Introduction	21
1.2 The Occluder	22
1.2.1 Structure of the Occluder	22
1.2.2 History of the occluder	24
1.2.2.1 Tissue glue	24
1.2.2.2 Metal devices	25
1.2.2.3 Biodegradable occluders	27
1.2.2.4 Occluder variants	28
1.3 Formulation of a novel Transcatheter Drug Delivery	29
1.3.1 Conventional therapy for occlusal diseases	29
1.3.2 Advanced drug delivery system targeting the occlusum	31
1.3.2.1 Solutions, suspensions and emulsions	33
1.3.2.2 Gels and hydrogels	36
1.3.2.3 Microcapsules, patches and films	37
1.3.2.4 Liposomes	38
1.3.2.5 orally disintegrating tablets (ODTs)	40
1.3.2.6 Chewable tablets	41
1.3.2.7 Chewable gums	42
1.3.2.8 Laminar delivery of therapies buccal/intra	43
1.4 Experimental Methodology to Investigate the Potential of the Occlusal Adhesion	45
1.4.1 Animal models to assess occlusal bioadhesion	45

Contents

1	Introduction to Oesophageal Drug Delivery	21
1.1	Introduction	21
1.2	The Oesophagus	22
1.2.1	Structures of the oesophagus	22
1.2.2	Diseases of the oesophagus	24
1.2.2.1	Infectious diseases	24
1.2.2.2	Motility disorders	25
1.2.2.3	Gastro-oesophageal reflux disease	27
1.2.2.4	Oesophageal cancer	28
1.3	Evaluation of Current Oesophageal Drug Delivery	29
1.3.1	Conventional therapy for oesophageal diseases	29
1.3.2	Advanced drug delivery system targeting the oesophagus	31
1.3.2.1	Solutions, suspensions and emulsions	33
1.3.2.2	Gels and pastes	36
1.3.2.3	Buccal tablets, patches and films	37
1.3.2.4	Lozenges	38
1.3.2.5	Orally disintegrating tablets (ODTs)	40
1.3.2.6	Chewable tablets	41
1.3.2.7	Chewable gums	42
1.3.2.8	Luminally delivered therapies bioadhesion	43
1.4	Experimental Methodology to Investigate the Potential of the Oesophageal Adhesion	45
1.4.1	<i>In vitro</i> methods to assess oesophageal bioadhesion	45

CONTENTS

1.4.1.1	A comparison of the reported <i>in vitro</i> adhesion within the oesophagus	47
1.4.1.2	Apparatus used in <i>in vitro</i> oesophageal adhesion studies	47
1.4.1.3	Comparison of <i>in vitro</i> used to measure oesophageal adhesion of liquids	47
1.4.2	Techniques used to observe oesophageal transit <i>in vivo</i>	54
1.4.2.1	Gamma Scintigraphy	55
1.4.2.2	Clinical X-ray	56
1.4.2.3	Endoscopic visualisation	57
1.4.2.4	Impedance plainmetry	57
1.4.2.5	Endoscopic ultrasound	58
1.4.2.6	Magnetic resonance imaging (MRI)	58
1.4.3	<i>In vitro-in vivo</i> correlation of oesophageal adhesion	59
1.5	Further Challenges and Innovations in Oesophageal Drug Delivery	60
1.5.1	Mucoadhesive/bioadhesive system	60
1.5.2	Characterisation of the oesophageal surface layer	63
1.5.3	Magnetic targeting	64
1.5.4	Modulation of adherence	65
1.5.5	Modelling the oesophagus to design an adhesive coating	65
1.5.6	Artificial lower oesophageal sphincter	66
1.6	Aims and Objectives	66
2	Bioadhesive Liquids for Oesophageal Drug Delivery	68
2.1	Introduction	68
2.1.1	Miconazole nitrate salt	69
2.1.2	Bioadhesives	70
2.1.2.1	Chitosan	70
2.1.2.2	Xanthan gum	72
2.1.3	The objectives of this chapter	73
2.2	Materials and Methods	74
2.2.1	Materials	74

CONTENTS

2.2.2	Determination of the absorbance peak of model drugs with UV spectrophotometer	74
2.2.2.1	Porcine oesophageal tissue for ex vivo experiments	74
2.2.3	Preparation of formulations	75
2.2.4	Addition of technetium label to the formulation for the retention study	75
2.2.5	Viscosity of formulations	77
2.2.6	Assessing the adhesive potential of the formulation	77
2.2.7	Release of the drug	78
2.2.8	Efficacy of the drug	80
2.2.8.1	Efficacy procedure of bioadhesive drug carriers	80
2.2.8.2	Determination of minimal inhibitory concentration of drug <i>via</i> growth on agar plates	81
2.2.9	Statistical significance test	83
2.3	Results and Discussion	83
2.3.1	UV quantification of miconazole	83
2.3.2	Viscosity effect of solubility enhancers in hydrogel liquids	83
2.3.3	Retention of the formulations	85
2.3.4	Release of the drug	87
2.3.5	MIC study	90
2.4	Chapter Summary and Conclusions	91
2.4.1	Evaluation of bioadhesive liquid targeting the oesophagus	91
3	Orally Retained Hydrophilic Films for Oesophageal Drug Delivery	93
3.1	General Background	93
3.1.1	Oral retained dosage forms	93
3.1.2	Cellulose and its derivatives	94
3.1.3	Drug release kinetics by mathematical modelling	95
3.1.4	Microviscometry to quantify polymer dissolution	97
3.1.5	Orally retained films	98
3.2	Materials and Methods	98
3.2.1	Materials	98

CONTENTS

3.2.2	HPLC analysis of miconazole	99
3.2.3	Film preparation	99
3.2.4	Physical and mechanical measurement	100
3.2.4.1	Film thickness and weight uniformity	100
3.2.4.2	Measurement of film swelling	100
3.2.4.3	Measurement of mechanical properties	101
3.2.4.4	Oral retention model	103
3.2.5	Drug release apparatus	104
3.2.5.1	Analysis of drug release data	105
3.2.6	Determination of polymer dissolution	105
3.2.6.1	Determination of polymer dissolution from films .	106
3.2.7	MIC study of orally retained films	106
3.2.7.1	Cell culture preparation	106
3.2.8	Statistical analysis	106
3.3	Results and Discussion	107
3.3.1	HPLC calibrations	107
3.3.2	Linear calibrations of the polymers	109
3.3.3	Physical and mechanical behavior of the films	109
3.3.3.1	The effect of polymer composition of the films when polymer concentration was kept constant .	109
3.3.3.2	The effect of polymer composition in the films . .	114
3.3.3.3	The effect of polymer molecular weight used to prepare the films	115
3.3.4	<i>In vitro</i> drug release mechanism from orally retained films	117
3.3.4.1	The effects of glycerol in different matrices with different hydrophilicity behaviors	117
3.3.4.2	The influence of polymer concentration and com- position on drug release from film matrices	120
3.3.4.3	The drug release kinetics study by using the poly- meric systems (HPMC) at different molecular weight grade	121
3.3.5	MIC study of buccal films	129
3.4	Chapter Summary and Conclusions	131

3.4.1 Orally retained films drug release mechanisms	131
4 Orally Retained Tablet for Oesophageal Drug Delivery	133
4.1 Introduction	133
4.2 Materials and Methods	134
4.2.1 Materials	134
4.2.2 Direct compression tableting	134
4.2.3 Drug dissolution apparatus	136
4.2.3.1 Analysis of drug release data	136
4.2.4 Polymer dissolution from orally retained tablets	137
4.2.5 Statistical analysis	137
4.3 Results and Discussion	137
4.3.1 Linear calibrations of celluloses	137
4.3.2 Drug release from pure polymeric tablets	137
4.3.3 Effect of the additional release controlling excipients	143
4.3.4 Drug release behavior affected by the diluents	144
4.3.5 Drug loading effect on the release kinetics	145
4.4 Chapter Summary and Conclusions	149
4.4.1 Drug release mechanism from orally retained tablets	149
5 Chewable Tablets as a Strategy Targeting The Oesophagus and In Vitro Dissolution Methods to Evaluate Release from Chew- able Tablets	151
5.1 Introduction	151
5.2 Materials and Methods	154
5.2.1 Materials	154
5.2.2 Preparation of the chewable tablets	155
5.2.3 Drug release apparatus	155
5.2.3.1 Rotating basket	155
5.2.3.2 Paddle method	156
5.2.3.3 PhEur chewing apparatus	156
5.2.3.4 Modified paddle apparatus	156
5.2.4 Sodium alginate dissolution determined <i>via</i> microviscometry	158
5.3 Results and Discussion	158

CONTENTS

5.3.1	Linear calibrations of sodium alginate viscosity	158
5.3.2	Profiles obtained from various dissolution testing methods	158
5.3.3	Profiles obtained from basket method	160
5.3.4	Profiles obtained from chewing apparatus	163
5.3.5	Profiles obtained from paddle method	163
5.4	Chapter Summary and Conclusions	165
5.4.1	Appropriate dissolution apparatus for chewable tablet . . .	165
6	General Conclusions and Future Work	167
6.1	General Conclusion	167
6.1.1	The overall assessment of research outcomes	167
6.1.2	Potential of bioadhesive liquids for local oesophageal drug delivery	168
6.1.3	Evaluation of orally retained dosage forms targeting the oesophagus	171
6.1.3.1	Hydrophilicity of matrix system	171
6.1.3.2	Microviscometry as a technique to quantify poly- mer dissolution	173
6.1.3.3	Drug release mechanism from matrix system . . .	174
6.2	Future Work	176
6.2.1	Formulations approaches to oesophageal drug delivery . . .	176
7	Bibliography	180

List of Figures

1.1	Details of the apparatus used for the <i>in vitro</i> measurement of oesophageal retention: the everted rat oesophagus model(Dobrozsi et al. 1999)	51
1.2	Details of the apparatus used for the <i>in vitro</i> measurement of oesophageal retention: the flow model (Smart et al. 2003)	52
1.3	Details of the apparatus used for the <i>in vitro</i> measurement of oesophageal retention: the flow model that has been adapted to include peristalsis (Richardson et al. 2005)	53
1.4	A comparison of the percentage of an applied formulation retained on porcine oesophageal tissue after 10 minutes of washing with artificial saliva. This figure is taken from Batchelor (2005).	54
2.1	Retention model apparatus (Tang 2004)	76
2.2	Schematic representation of the vertical diffusion cell (Tang 2004)	79
2.3	The distribution of samples on agar plate in MIC of formulation study	82
2.4	Calibration of miconazole nitrate in release experiment (data shows means \pm S.D., $n=4$)	84
2.5	The viscosity of the formulations investigated within this study (data shows means \pm S.D., $n=4$), error bars show plus and minus standard deviations	85
2.6	The retention profile of 2%w/v xanthan-based formulation in different vehicles;(data shows means \pm S.D., $n=4$)	86
2.7	The retention profile of 2%w/v chitosan-based formulation in different vehicles; (data shows means \pm S.D., $n=4$)	87

LIST OF FIGURES

2.8	A comparison of the rate of miconazole release from solutions of chitosan and xanthan gum using PEG to enhance solubility; (▲) for 2%w/v Chitosan with 10%v/v PEG; (■) for 2%w/v chitosan with 25%v/v PEG; (●) for 2%w/v xanthan gum with 10%v/v PEG; (◆) for 2%w/v xanthan gum with 25%v/v PEG; (data shows means ± S.D., n=4)	88
2.9	A comparison of miconazole release from solutions of chitosan containing PEG or glycerol at 10%v/v or 25% glycerol at time points of 10 minutes, 20 minutes and 30 minutes; (data shows means ± S.D., n=4)	89
3.1	The tensile apparatus for mechanical properties study of buccal films	103
3.2	Apparatus used for measurement of residence time of formulations	104
3.3	Calibration curve of MN using HPLC assay with the series of concentration at 0.00625, 0.0125, 0.025, 0.05, 0.1mg/mL (data shows means ± S.D., n=4)	107
3.4	Calibration curve of MN using HPLC assay with the series of concentration at 0.0625, 0.125, 0.25, 0.5 and 1mg/mL (data shows means ± S.D., n=4)	108
3.5	Calibration curve of MN using HPLC assay with the series of concentration from 0.00625 to 1mg/mL (data shows means ± S.D., n=4)	108
3.6	Calibration curve of HPMC (100cps) using microviscometry assay with the series of concentration from 0.0015 to 0.025mg/mL (data shows means ± S.D., n=4)	110
3.7	Calibration curve of HPMC (4,000cps) using microviscometry assay with the series of concentration from 0.0007 to 0.0125mg/mL (data shows means ± S.D., n=4)	110
3.8	Calibration curve of HPMC (15,000cps) using microviscometry assay with the series of concentration from 0.0003 to 0.005mg/mL (data shows means ± S.D., n=4)	111
3.9	A schematic illustration of the swelling hydrated films	112
3.10	A schematic illustration of the effect of glycerol on the swelling behaviour of the hydrated films	112

LIST OF FIGURES

3.11	Typical traces of the mechanical properties of the films; the force required to stretch and break the films versus distance is shown	114
3.12	The contributions of Fickian diffusion and polymeric relaxation in the drug release from MC film containing 5%v/v glycerol (data shows means±S.D., n=4)	118
3.13	The contributions of Fickian diffusion and polymeric relaxation in the drug release from MC film containing 10%v/v glycerol (data shows means±S.D., n=4)	119
3.14	Fickian release fraction as a function of released miconazole from HEC and HPMC films with 5%v/v and 10%v/v glycerol respectively (data shows means±S.D., n=4)	119
3.15	Fraction of miconazole released from MC and HPMC films with different polymer contents: MC2G5 (●); MC4G5 (○); HPMC6G5 (△); HPMC8G5 (▲) (data shows means±S.D., n=4)	122
3.16	Fickian release fraction as a function of released miconazole from MC, HEC and HPMC films with different polymer content respectively (data shows means±S.D., n=4)	122
3.17	The contributions of Fickian diffusion and polymeric relaxation in the drug release from HEC film containing 5%v/v glycerol and 4%w/v HEC (n=4). (Compared to the most contribution from diffusional release mechanisms, the drug release according to the polymer relaxation was very little.)	123
3.18	The contributions of Fickian diffusion and polymeric relaxation in the drug release from HEC film containing 5%v/v glycerol and 6%w/v HEC (n=4)	123
3.19	Fraction of miconazole released from HPMC films containing 5% v/v glycerol using different molecular weight (MW) grade: 100cps(□); 4,000cps(○) and 15,000cps(×). Lines represent fitted data according to Equation 3.1 (data shows means±S.D., n=4)	124
3.20	The contributions of Fickian diffusion and polymeric relaxation in the drug release from HPMC (100cps) film containing 10%v/v glycerol (data shows means±S.D., n=4)	126

LIST OF FIGURES

3.21	The contributions of Fickian diffusion and polymeric relaxation in the drug release from HPMC (4,000cps) film containing 10%v/v glycerol (data shows means±S.D., $n=4$)	126
3.22	The contributions of Fickian diffusion and polymeric relaxation in the drug release from HPMC (15,000cps) film containing 10%v/v glycerol (data shows means±S.D., $n=4$)	127
3.23	Glycerol effect on the fraction of polymer dissolution (\blacktriangle) and the fraction of drug release (\blacksquare) from 2% HPMC (100cps) films; (data shows means±S.D., $n=4$)	128
3.24	Glycerol effect on the fraction of polymer dissolution (\blacktriangle) and the fraction of drug release (\blacksquare) from 2% HPMC (4,000cps) films; (data shows means±S.D., $n=4$)	128
3.25	Glycerol effect on the fraction of polymer dissolution (\blacktriangle) and the fraction of drug release (\blacksquare) from 2% HPMC (15,000cps) films; (data shows means±S.D., $n=4$)	129
4.1	Calibration curve of MC using microviscometry assay with the series of concentration from 0.003125 to 1mg/mL (data shows means±S.D., $n=4$)	138
4.2	Calibration curve of HEC using microviscometry assay with the series of concentration from 0.003125 to 1mg/mL (data shows means±S.D., $n=4$)	138
4.3	Calibration curve of HPMC using microviscometry assay with the series of concentration from 0.003125 to 1mg/mL (data shows means±S.D., $n=4$)	139
4.4	Fractional release of miconazole nitrate from HPMC40 tablet (\square); MC40 tablet (\circ); HEC40 tablet (\triangle); Lines represent fitted data according to Equation 3.1 (data shows means±S.D., $n=4$)	140
4.5	Fickian release fraction as a function of released miconazole from pure polymeric tablets; MC40 (\bullet); HPMC40 (\blacksquare); HEC40 (\blacktriangledown) (data shows means±S.D., $n=4$)	142

LIST OF FIGURES

4.6	The effect of Carbopol®974P on the percentage of miconazole release after 180 minutes: the tablet containing 40mg polymer as control (■); the tablets added with 5mg Carbopol®974P (■) (data shows means±S.D., n=4)	143
4.7	The lactose effect in polymer dissolution from MC tablets (data shows means±S.D., n=4)	145
4.8	The lactose effect in contributions of Fickian diffusion and polymeric relaxation in the drug release from HEC tablets (data shows means±S.D., n=4)	146
4.9	The lactose effect in contributions of Fickian diffusion and polymeric relaxation in the drug release from HPMC tablets (data shows means±S.D., n=4)	146
4.10	The comparison of drug release and polymer dissolution from HEC tablets with/without lactose (data shows means±S.D., n=4)	146
4.11	The comparison of drug release and polymer dissolution from HPMC tablets with/without lactose (data shows means±S.D., n=4)	147
4.12	The effect of drug loading on the percentage of miconazole release after 90 minutes: the tablet containing polymer and drug at 4:1(■); the tablets containing polymer and drug at 1:4 (■) (data shows means±S.D., n=4)	148
5.1	Schematic diagram of the chewing chamber of an <i>in vitro</i> chewing apparatus (Conway & Batchelor 2007)	157
5.2	Modified paddle apparatus for chewable tablets	157
5.3	Calibration curve of sodium alginate using microviscometry assay with the series of concentration from 0.3125 to 5mg/mL (data shows means±S.D., n=6)	159
5.4	Drug release study of chewable tablet containing 500mg sodium alginate and 500mg Witepsol®H15, using different apparatus: chewing apparatus, rotating basket and paddle alone (data shows means±S.D., n=6)	160
5.5	Comparison of drug release using basket method: whole tablet (■); crushed tablet (▲) (data shows means±S.D., n=6)	162

LIST OF FIGURES

- 5.6 Comparison of polymer dissolution using basket method: whole tablet (■); crushed tablet (▲) (data shows means±S.D., $n=6$) . . . 162
- 5.7 The chewable tablets drug release profiles using chewing apparatus (data shows means±S.D., $n=6$) 163
- 5.8 Comparison of drug release using paddle alone and paddle-over-glass beads (data shows means±S.D., $n=6$) 165

List of Tables

1.1	Conventional treatment options (including formulation alternatives) available for a range of oesophageal diseases	30
1.2	A summary of patents that relate to bioadhesive liquids for oesophageal drug delivery (Part 1; to be continued)	34
1.3	A summary of patents that relate to bioadhesive liquids for oesophageal drug delivery (Part 2)	35
1.4	Patents that describe chewing gum formulations that may be applicable for the treatment of oesophageal diseases	44
1.5	A comparison of the tests available to measure oesophageal retention <i>in vitro</i> ; Part 1; to be continued	48
1.6	A comparison of the tests available to measure oesophageal retention <i>in vitro</i> ; Part 2; to be continued	49
1.7	A comparison of the tests available to measure oesophageal retention <i>in vitro</i> ; Part 3	50
2.1	The mixture samples in the plate for adhesive formulation efficacy study) available for a range of oesophageal diseases	81
2.2	The MIC (minimum inhibition concentration) of miconazole nitrate in chitosan hydrogel formulations and xanthan gum hydrogel formulations ($n=6$)	90
3.1	The properties and composition of solutions used to prepare films where glycerol composition was the main variable investigated (viscosity data shows means \pm S.D., $n=4$)	100

LIST OF TABLES

3.2	The properties and composition of solutions used to prepare films where the concentration of each polymer was investigated as the variable (viscosity data shows means±S.D., $n=4$)	101
3.3	The properties and composition of solutions used to prepare films where the molecular weight (100cps, 4,000cps and 15,000cps) of a single polymer was investigated	102
3.4	The limit of detection (LOD) and quantification (LOQ) for the calibrations of miconazole nitrate	109
3.5	The physical and mechanical properties of the films prepared from 4 %w/v polymer solutions (thickness data shows means±S.D., $n=10$; thickness data shows means±S.D., $n=4$)	113
3.6	The effect of polymer concentration in the physical and mechanical properties of the films (data shows means±S.D., $n=4$)	115
3.7	The viscosity grade of HPMC used to prepare films and the physical and mechanical properties of the films (data shows means±S.D., $n=4$)	116
3.8	Diffusional coefficient, n and release constant k (Equation 3.1); diffusional (k_1) and relaxational (k_2) kinetic constants (Equation 3.2) and the correlation coefficient (r^2) for drug release from each different polymeric film matrices with different concentration of glycerol (mean data fitted from $n=4$)	117
3.9	Diffusional coefficient, n and release constant k (Equation 3.1); diffusional (k_1) and relaxational (k_2) kinetic constants (Equation 3.2) and the correlation coefficient (r^2) for drug release from each film with different polymer content (mean data fitted from $n=4$) .	121
3.10	Diffusional coefficient, n and release constant k (Equation 3.1); diffusional (k_1) and relaxational (k_2) kinetic constants (Equation 3.2) and the correlation coefficient (r^2) for drug release of the HPMC films using different molecular weight (mean data fitted from $n=4$)	125
3.11	Scores of MIC study;the original formulation containing 5mg/mL MN ($n=6$)	130

LIST OF TABLES

4.1	The variable composition of tablets for the effects on drug release study	135
4.2	Diffusional coefficient, n and release constant k (Equation 3.1); diffusional (k_1) and relaxational (k_2) kinetic constants (Equation 3.2) and the correlation coefficient (r^2) for drug release from each tablet with different polymer content (data shows means \pm S.D., $n=4$)	141
4.3	Diffusional coefficient, n and release constant k (Equation 3.1); diffusional (k_1) and relaxational (k_2) kinetic constants (Equation 3.2) and the correlation coefficient (r^2) for drug release from each tablet with/without Carbopol [®] 974P (data shows means \pm S.D., $n=4$)	144
4.4	The effect of the ratio between the polymer and the drug on the fraction of released drug by diffusional control ($r^2 > 0.95$, data shows means \pm S.D., $n=4$)	148
5.1	The compositions and formulations of chewable tablets ($n=6$) . . .	155
5.2	Drug release study of chewable tablet containing 500mg sodium alginate and 500mg Witepsol [®] H15 and 50mg miconazole nitrate, using different apparatus: chewing apparatus, rotating basket and, paddle alone (data shows means \pm S.D., $n=6$)	159
5.3	Drug release study of chewable tablet containing 500mg sodium alginate and 500mg Witepsol [®] H15 in whole tablet and crushed pieces respectively, using rotating basket (data shows means \pm S.D., $n=6$)	161
5.4	Drug release study of chewable tablet containing 500mg sodium alginate and 500mg Witepsol [®] H15 in whole tablet and crushed pieces respectively, using rotating basket (data shows means \pm S.D., $n=6$)	164

Chapter 1

Introduction to Oesophageal Drug Delivery

1.1 Introduction

The oesophagus as a site for drug delivery has been much overlooked in comparison to the remainder of the gastro-intestinal (GI) tract. However, diseases of the oesophagus are relatively common and therapy is restricted to systemic treatment, most usually by standard dosage forms, even though the local blood supply to this organ is poor. This treatment strategy means that high drug doses are required which can lead to side effects. For example, systemic administration of antifungal agents to treat oesophageal candidiasis can lead to many drug interactions as well as unwanted side effects (Klastersky 2004). Localised, targeted drug delivery to the oesophagus offers the potential for more effective delivery and reduced drug dosages, coupled with increased patient compliance for disorders where swallowing of tablets or capsules is problematic or uncomfortable.

Gastro-oesophageal reflux disease (GORD) is the most prevalent of all oesophageal disorders and the associated market is huge; the overall prevalence of GORD has been estimated at 10% to 20% in the Western world, and nearly 20 million Americans suffer from the disease (Dean et al. 2003). The economic burden of GORD also is substantial, with nearly \$10 billion in direct costs alone (Dean et al

2003). Oesophageal infections are increasing with growing numbers of immunocompromised hosts, including those with HIV or undergoing cancer chemotherapy. Oesophageal motility disorders are infrequent but extremely debilitating when they do occur. Achalasia is a primary oesophageal motor disorder of unknown aetiology and the most common of oesophageal motility disorders with a reported incidence of 0.5-1 per 100,000 in the United States (Woltman et al. 2004). Targeted therapies to the oesophagus offer many advantages in several disease states, particularly those where localised action is beneficial, this thesis reports on the existing and novel strategies available.

Oesophageal diseases are generally treated systemically although local delivery offers many advantages. In order for local treatment to be successful the drug needs to be retained at the site of action for a sufficient period of time in a sufficiently high concentration.

1.2 The Oesophagus

1.2.1 Structures of the oesophagus

In order to better understand the challenges involved in oesophageal-targeted drug delivery, it is important to have an insight into the anatomical and physiological characteristics of the oesophagus. The oesophagus is a tubular structure approximately 25mm in diameter (Boyce 1999) and 23cm in length (Li et al. 1994) providing the pathway *via* which ingested food and drink are carried to the stomach. The surface area of the oesophagus is estimated to be 180cm² and can expand the overall absorptive area within the GI tract. The oesophagus is lined by non-keratinised squamous epithelium with an average thickness of 500-800 μ m, lying over a lamina propria and the muscularis mucosa (Bouchier et al. 2005; Stevens & Lowe 1997). The stratified squamous epithelium is a tough lining to resist distress caused by bolus abrasion.

The anatomical structure of the oesophagus consists of the upper oesophageal sphincter, lower oesophageal sphincter and the oesophageal muscular body. The

1.2 The Oesophagus

upper oesophageal sphincter is striated muscle forming a ring that acts to open and close during swallowing. The lower oesophageal sphincter (LOS) represents the transition between the oesophagus and stomach and is about 3-4cm in length (Sloan et al. 1992). It is at the junction of squamous and columnar epithelium and at this point the oesophagus meets the stomach. The oesophageal body, between the upper and lower oesophageal sphincters, serves to transit swallowed boluses to the stomach. The resting pressure of the oesophagus changes due to breathing. During inspiration the pressure is between -5 to -10mmHg and during expiration it is 0 to 5mmHg (Washington et al. 2001; Woltman et al. 2004)

There are four tissue layers within the oesophagus: a fibrous external layer, a muscular layer, a submucous layer and an internal mucous-type layer (Washington et al. 2001; Woltman et al. 2004). The external fibrous layer consists of elastic fibres. The muscular layer is composed of circular muscle surrounded by longitudinal muscle. The submucosal layer contains larger blood vessels, nerves and mucous glands that loosely connect the mucous and muscular layers. The internal mucosal is covered with a layer of stratified squamous epithelium lining extending from the buccal cavity continuing through the pharynx and down to the oesophagus and ends at the LOS. It provides a tough impermeable lining resisting the abrasive nature of food boluses.

The oesophageal glands are located in submucosa and distributed throughout the length of the oesophagus, they are small racemose glands of mucus type and each with a long duct opening in the lumen (Washington et al. 2001; Woltman et al. 2004). About 600-700 glands in total are present in the oesophagus making the oesophagus moist rather than wet (Namiot et al. 1994a). The main function of the secretions is to lubricate the tube and protect the lower part of the oesophagus from gastric reflux *via* the pre-epithelial defences within the oesophagus. A secondary function lies in the control of physiological reflux. Gastric reflux is a physiological event that occurs in all individuals that is reported to occur more frequently after meals (Ippoliti 1983).

The pH within the oesophagus is similar to that of saliva at about 6-7 (Washington et al. 2001); whereas the pH within the stomach is between 1.5 and 2 in the fasted state. At the junction between the oesophagus and the stomach, the lower oesophageal sphincter of the epithelial lining changes into stomach epithelium that is columnar and covered in a protective mucus layer, which is necessary to protect the tissue from the local acidic environment. For a full review of the histological differences between esophageal and gastric epithelia the reader is referred to (Kahrilas 2000). In the relaxed state the oesophagus is highly folded and expands as necessary upon swallowing. A swallow is a voluntary action that is associated with a peristaltic wave moving down the oesophagus to clear food boluses or swallowed saliva. The speed of the peristaltic wave has been measured to be 2 - 6cm per second with the typical transit time of dosage forms has been calculated to be 10 - 14 seconds (Washington et al. 2001). Secondary peristalsis is an involuntary action that occurs over the lower region of the oesophagus. It is initiated in response to distension within the oesophagus that may be caused by adherent food particles or refluxed gastric material.

1.2.2 Diseases of the oesophagus

1.2.2.1 Infectious diseases

Oesophageal infections are often, although not always, associated with immunocompromised hosts; during the past two decades, the frequency of oesophageal fungal infections has risen in parallel with increasing numbers of immunocompromised hosts, such as patients with HIV infection, chemotherapy-induced neutropenia and transplant patients undergoing immunosuppressive therapy (Chiou et al. 2000). *Candida* and *herpes* simplex virus are the most common infections although bacterial (e.g. mycobacterium tuberculosis) and viral (e.g. varicella-zoster virus) infections have also been cited (Bonacini 2001). Oesophageal candidiasis has been reported to be the most frequent opportunistic infection in patients with AIDS, thereby significantly reducing the quality of life of those already severely ill and a major cause of blood septicaemia (Jankowska et al. 2001). Oesophageal candidiasis is also associated with high relapse rates following treatment; 81% of cases in immunosuppressed patients treated with systemically delivered azoles

had a relapse within 10 weeks (Laine 1994). Therefore, effective treatment of *Candida* infections has become increasingly clinically relevant. Localised delivery of antifungal agents to sites of infection is an important area of research and much work has been performed to aid the design of such systems (Llabot et al. 2007; Ruissen et al. 1999; Senel et al. 2000; Tang et al. 2005).

Formulations used for the treatment of oral and oesophageal infections include, tablets, capsules, oral solutions, oral suspensions and injectables for systemic therapy. Localised therapies include mouthwashes, oral gels, oral sprays, oral syrups, lozenges and pastilles. Buccal miconazole tablets (Loramyc[®], BioAlliance Pharma) have also recently been introduced for the treatment of oropharyngeal infections. Polyene antifungals (amphotericin and nystatin) are not absorbed when given orally but are licensed for topical use within the oral cavity and oesophagus; imidazole antifungal agents (e.g. clotrimazole, miconazole) are licensed for local use within the oral cavity although these agents also provide systemic action; triazole antifungals (e.g. fluconazole, itraconazole) are licensed for systemic uptake in the treatment of oral/oesophageal infections.

1.2.2.2 Motility disorders

Disorders of oesophageal motor function, also known as motility disorders, include achalasia, diffuse oesophageal spasm (DOS) and nutcracker oesophagus (NOes) (Adler & Romero 2001).

Achalasia

Achalasia is the best understood oesophageal motor disorder, most common in middle age, but occurring in all age groups and both sexes (Mittal 1997). Achalasia is a motor disease of the oesophageal body smooth muscle and the LOS, causing failure of the hypercontractile LOS to relax when swallowing and aperistalsis of the oesophageal body (Adler & Romero 2001; Mittal 1997; Richter 2001; Triadafilopoulos et al. 1991). The result of the achalasia is delayed oesophageal emptying through the LOS, with residual food and fluids remaining in the oesophagus, causing regurgitation of undigested food and cough when lying

down. The lack of peristalsis causes dysphagia (difficulty swallowing) and weight loss. Achalasia is associated with an increased risk of developing oesophageal carcinoma, in particular oesophageal squamous cell carcinoma (OeSCC) (Sandler 1995). Traditionally, pneumatic dilatation was the first line of treatment for oesophageal achalasia, while surgery was reserved for patients who had persistent dysphagia after multiple dilatations or who had suffered a perforation during dilatation. However, minimally invasive surgery has completely changed this treatment algorithm and a laparoscopic Heller myotomy and partial fundoplication is preferred by most gastroenterologists and surgeons as the primary treatment modality (Bonatti et al. 2005). Pharmacological treatment focuses on smooth muscle relaxants given orally for systemic uptake including calcium channel blockers such as nifedipine, and nitrates such as isosorbide dinitrate and nitroglycerin.

Diffuse oesophageal spasm

Diffuse oesophageal spasm (DOS) is a spastic oesophageal disorder in which manometry findings include abnormal, intermittent, prolonged (>6 sec), swallow-induced, simultaneous contractions of the oesophageal body (Richter 2001). More specifically, the disease is defined by the presence of simultaneous contractions after 20 percent or more of wet swallows (Clouse & Hallett 1992; Richter 2001). Sperandio et al (2002) reported that the simultaneous contractions (spasms) in DOS patients are exclusively found in the distal smooth muscle segment. The symptoms of DOS are dysphagia and chest pain. The pain is highly variable in severity and duration (Richter 2001) and is not only associated with swallowing or eating. Unlike achalasia, symptoms are typically non-progressive. Many patients also have some lower oesophageal sphincter (LOS) dysfunction, this can be raised LOS pressure or impaired LOS relaxation, and sometimes both (Mittal 1997).

Nutcracker oesophagus

In Nutcracker Oesophagus (NOes), also known as hypercontractile oesophagus, the patient has normal peristalsis but the swallow-induced pressure waves are of high amplitude and duration (>6 sec) (Castell 1995; Lee et al. 2003). This

results in chest pain and dysphagia which are non-progressive and not associated with eating. Manometric diagnosis requires a mean distal peristaltic amplitude of $>180\text{mmHg}$. The lower oesophageal sphincter has normal relaxation but baseline pressure is elevated to above 40mmHg . Although the pathogenesis of NOes is unknown, it may result from an imbalance between the excitatory and inhibitory elements of oesophageal innervation (Lee et al 2003).

Hypertensive lower oesophageal sphincter (LOS) is an uncommon manometric abnormality involving a raised LOS pressure ($>35\text{-}40\text{mmHg}$) (Tamhankar et al. 2003), but otherwise there is normal oesophageal contraction amplitude, duration and peristalsis. This can cause mild to moderate dysphagia in the individual.

Therapeutic interventions to treat spastic disorders

DOS, NOes and hypertensive LOS are also known as spastic disorders of the oesophagus (Mittal 1997). Pharmacotherapy of these disorders may be considered together as the symptoms and goals of treatment are similar. There is hyper-contractility of the LOS muscle, oesophageal body, or both, which require correction. The treatment options for these disorders are based on smooth muscle relaxant therapy, administered systemically in all cases. Commonly treatments are administered as tablets for systemic uptake although nitroglycerine administered sublingually has demonstrated efficacy for acute episodes. Work carried out by (Miller et al. 1995) suggests that botulinum toxin, already used in achalasia treatment, could be useful in treating DOS, as it relieves dysphagia and chest pain.

1.2.2.3 Gastro-oesophageal reflux disease

Gastro-oesophageal reflux disease (GORD) is caused by excessive reflux of acid and bile from the stomach back up into the oesophagus despite the physiological mechanisms to prevent this occurring. GORD is a common affliction in the Western world, and treatment costs are substantial because of its prevalence. Gastric reflux is a physiological event occurring frequently even in healthy individuals, however pathological reflux can lead to oesophageal damage (Orlando 2000) and

symptoms of GORD. In the UK, up to 40% of adults may suffer from dyspepsia in a year, and 25% of those may be categorised as having GORD (NICE 2000). Potentially serious complications of GORD include strictures, erosive oesophagitis and development of Barrett's Oesophagus, leading to an increased risk of oesophageal adenocarcinoma (Kinnear et al. 1999; Savarino & Dulbecco 2004; Solaymani-Dodaran et al. 2004).

1.2.2.3.1 Therapeutic interventions to treat GORD Current treatment options available for GORD include self-treatment with antacids or alginate antacids; H₂ antagonists or proton pump inhibitors to reduce acid secretion within the stomach or, for chronic cases, luminally administered devices that constrict the oesophagus have also been used (e.g Enteryx[®], Boston Scientific).

1.2.2.4 Oesophageal cancer

Cancer of the oesophagus is the ninth most common malignancy worldwide (McCabe & Dlamini 2005), and its incidence has been increasing over the past three decades (Caldas 2000). High incidence areas include China, South Africa, Western Europe and the former Soviet Union (Pickens & Orringer 2003). Over 7,000 new cases are diagnosed each year compared with 10,000 gastric carcinomas (Cancer Research Campaign 1998). In 2005, the worldwide burden of oesophagogastric cancer was estimated to be 1,500,000 new cases (500,000 oesophagus and 1,000,000 stomach). In 2025, it is estimated that the number of new cases will rise to 2,110,000 (Ferlay 1992). The two main categories of oesophageal cancer are squamous carcinoma (OeSCC) and adenocarcinoma (OeAC).

Thirty years ago, most oesophageal cancers were squamous carcinomas, however, the incidence of OeAC has been increasing more rapidly than any other cancer over the last 3 decades (Lambert & Hainaut 2007). Oesophageal adenocarcinoma is no longer a rare neoplasm and is now at least as common as squamous carcinoma (Cameron 1997). Symptoms of oesophageal cancer include dysphagia, pain in the oesophagus, chronic cough, vomiting, hiccups and weight loss.

1.3 Evaluation of Current Oesophageal Drug Delivery

Squamous cell carcinoma starts in the squamous epithelial cells lining the oesophagus and usually affects the upper and middle thirds of the oesophagus. Adenocarcinoma starts in the mucus-producing glands of the oesophagus and mainly affects the lower third of the oesophagus. This type of cancer is most associated with GORD and Barrett's Oesophagus and the absolute risk of OeAC in those with uncomplicated reflux is low (Blot et al. 1991).

Management of oesophageal cancer remains an unsolved health problem (McCabe & Dlamini 2005). Surgery is the most common treatment and a partial or total oesophagectomy may be carried out (Haringsma 2002). Chemotherapy for oesophageal cancer is generally administered *via* intravenous injections.

Adenocarcinoma evolves *via* a series of stages and endoscopic surveillance provides the opportunity for early diagnosis and treatment for those considered to be at risk. During endoscopic examination the recommended practice is to take biopsies at regular intervals for histopathological analysis (Sampliner 1998).

Photodynamic therapy offers a non surgical alternative for the treatment of metaplasia, dysplasia and early carcinoma (Messmann et al. 1999). Photosensitisers (e.g. 5-aminolevulinic acid (5-ALA)) used in photodynamic therapy were originally administered intravenously with high doses (10-60mg/kg) that demonstrated limited tumour-selectivity. It is recognised that topical administration of 5-ALA and related compounds to the oesophagus would be beneficial (Collaud et al. 2007).

1.3 Evaluation of Current Oesophageal Drug Delivery

1.3.1 Conventional therapy for oesophageal diseases

Standard treatments for diseases of the oesophagus are systemic administration of drugs as required, currently chemotherapeutics used in the treatment of oesophageal diseases are listed in Table 1.1. Systemic therapy offers many benefits

1.3 Evaluation of Current Oesophageal Drug Delivery

Table 1.1: Conventional treatment options (including formulation alternatives) available for a range of oesophageal diseases

Oesophageal Disease	Chemotherapy Treatment Options	Formulation Options
Oesophageal infection	Systemic triazole agents (e.g. fluconazole, ketoconazole)	Intravenous injection, oral suspension, oral tablet, oral capsule
	Systemic amphotericin	Intravenous injection
	Local amphotericin, nystain	Lozenge, oral suspension
Motility disorders	Botulinium Toxin to weaken the oesophageal sphincters	Local injections administered endoscopically
	Pneumatic balloon dilation	Pneumatic balloon dilation
	Nitrates (e.g isosorbide dinitrate, glyceryl trinitrate) for systemic action	Sublingual tablets, aerosol spray, buccal tablets for systemic effect
	Calcium channel blockers (e.g. nifedipine, verapamil) for systemic action	Tablets, capsules, modified release tablets, oral solution, injection for systemic effect
Gastro-oesophageal reflux disease	Antacids	Suspension, chewable tablets, capsules
	Alginate antacids	Suspension, chewable tablets
	H ₂ antagonists (eg cimetidine, ranitidine)	Tablets, oral suspension, oral solution, effervescent tablets, oral syrup for systemic effect
	PPI (e.g omeprazole, esomeprazole)	Capsules, tablets, oral suspension for systemic effect
	Prokinetic agent (e.g. metoclopramide)	Tablets, oral liquids, injection for systemic effect
Oesophageal cancer	Cytotoxic antibiotics and antineoplastic drugs including: epirubicin, cisplatin, 5-FU, mitomycin C, capecitazine	Intravenous infusion orally for systemic distribution

1.3 Evaluation of Current Oesophageal Drug Delivery

in the manufacture and supply of safe and effective medicines. However, there are many conditions where localised therapy offers advantages. Conventional oral formulations for localised delivery, such as mouthwashes, rinses and oral gels are of limited use for extended delivery as they are incapable of maintaining effective salivary concentrations of drugs for prolonged periods, therefore these systems offer limited benefits in treating the oesophagus. However alternative dosage forms for localised oral drug delivery including orally retained tablets, films or chewing gums that provide prolonged salivary concentrations of drug may be of use in localised treatment of the oesophagus.

1.3.2 Advanced drug delivery system targeting the oesophagus

Drug delivery is now a significant driver of the global pharmaceutical industry with products incorporating innovative drug delivery systems offering substantial rewards and exciting opportunities. Drug delivery systems can improve a product's medicinal value by providing greater efficacy compared to conventional products on the market. Furthermore, the right drug delivery system can boost a product's market value by reducing compliance issues, such as multiple applications, side-effects and tolerability. Drug delivery technologies have also become an integral part of a product's life-cycle management - extending a drug's exclusivity and profitability. Advanced drug delivery formulations therefore, offer large market rewards and significant competitive advantages within the pharmaceutical industry. Further details of advanced drug delivery formulations targeting the oesophagus are listed within this thesis.

The oesophagus is a tubular structure providing the pathway *via* which ingested food and drink are carried to the stomach. However, due to the relatively fast transit through this organ and the poor blood supply, this site has limited realistic value for the systemic delivery of drugs. Typical transit times have been calculated to be 10-14 seconds (Washington et al. 2001). There are currently no marketed products designed for absorption within the oesophagus although

1.3 Evaluation of Current Oesophageal Drug Delivery

certain therapies for gastro-oesophageal reflux disease offer protection to the oesophagus due to retention over the surface (Tang et al. 2005).

In the treatment of local disorders, a significant advantage in targeting the oesophagus would be the resultant prolonged contact of the drug with the oesophageal surface providing increased drug exposure. This may be achieved either by application of a bioadhesive delivery device for retention within the oesophagus or by using orally retained dosage forms to provide a continuous flow of drug over the oesophageal surface. However, there are limitations associated with drug delivery targeted within the oesophagus; these relate to the size of the dose that can be administered, variability in bioavailability may also be an issue associated with variable saliva flow rates and clearance. In addition, accidental swallowing of delivery devices designed for oral retention could be problematic. The two most important factors in formulation design for orally delivered formulations are taste-masking and patient comfort as these will dictate compliance with such systems.

The use of orally retained dosage forms to target the oesophagus was the subject of a recent review paper ("Strategies and therapeutic opportunities for the delivery of drugs to the oesophagus", *Critical ReviewsTM in Therapeutic Drug Carrier Systems*, 2008) (Zhang et al. 2008) co-written by the author of this thesis and the information is also presented within this thesis as part of the overall introduction.

In a simple comparison of release of a hydrophilic agent from chewing gum, lozenges and sublingual tablets, no differences in distribution were observed between the formulations in the oral cavity, oesophagus and glottis. The duration of retention within the oral cavity was greatest for the sublingual tablet and shortest for the lozenge (Christrup et al. 1990). This study suggests that orally retained formulations are suitable for targeting the oesophagus and that this strategy is worthy of further investigation.

Bioadhesion within the oesophagus has been well documented, particularly for the unwanted adhesion of certain dosage forms. However, the adhesion of drug

1.3 Evaluation of Current Oesophageal Drug Delivery

containing liquid vehicles would provide a simple strategy to target the oesophagus. General research on bioadhesive drug delivery has focussed on the adhesion of solid dosage forms rather than liquids; however this thesis will bring together all research on liquid dosage forms relevant for targeting the oesophagus.

1.3.2.1 Solutions, suspensions and emulsions

There are many formulations readily available for the treatment of infections within the oral cavity that may also be useful for oesophageal treatment. For example, gels, mouthwashes and lozenges are routinely used for localised treatment within the oral cavity and these could also be used to deliver drugs, *via* swallowed saliva, to the oesophagus. Aqueous alginate solutions have previously been explored as oesophageal bandages for GORD therapy and also as potential adhesive drug delivery devices within the oesophagus (Batchelor et al. 2004; Potts et al. 2000; Tang et al. 2005). Other studies have examined the role of bioadhesive liquids within the oesophagus and these were reviewed by Batchelor (2005). A viscous liquid will demonstrate a longer transit time through the oesophagus (Bogaardt et al. 2007), thereby increasing the contact time between the drug and the site of action; in addition, there is no need for disintegration or dissolution as with solid dosage forms. This strategy has been the focus of the majority of patents that relate to localised drug delivery to the oesophagus as detailed in Table 1.2 and Table 1.3 . Incorporation of antifungal agents into a formulation that coats the oesophagus and provides retention of the drug at the site of action has been investigated (Zhang & Batchelor 2004); the study suggested that a topical formulation delivered orally to treat oesophageal candidiasis was feasible. Itraconazole oral solution (intended for systemic action) has been used in the treatment of oropharyngeal candidiasis, although the rationale for administration of a solution was ease of delivery rather than topical therapy. The benefits of topical action were, however, recognised (Wilcox et al. 1997). Likewise, the administration of fluconazole as a suspension led to a more rapid clinical cure compared to capsules and the topical effect was considered to be important and warrants further investigation (Laine & Rabeneck 1995). There are also reports where fluconazole suspension may be better able to treat oropharyngeal candidiasis *via* a “swish and swallow” technique compared to the tablet

1.3 Evaluation of Current Oesophageal Drug Delivery

Table 1.2: A summary of patents that relate to bioadhesive liquids for oesophageal drug delivery (Part 1; to be continued)

Patent No.&Date	Title	Summary	Assignee
US 5288497 Feb 1994	Compositions of oral dissolvable medicaments	A flavoured dissolvable matrix capable of enhancing absorption through the mucosal tissues of the mouth, pharynx, and esophagus.	University of Utah (Stanley & Hague 1994)
US 5554379 Sept 1996	Long acting GI and oesophageal protectant	A bioadherent, orally ingestible system, which comprises: a water-in-oil system	KV Pharmaceutical Company (Cuca et al. 1996a)
US 5554380 Sept 1996	Bioadhesive pharmaceutical delivery system	A water-in-oil ingestible system capable of treating an oral or esophageal disorder	KV Pharmaceutical Company (Cuca et al. 1996b)
US 5711936 Jan 1998	Ultramulsion based ingestible compositions	A high viscosity silicone in certain surfactants for use in treating the surface of the oesophagus which contains no mucus	WhiteHill Oral Technologies Inc (Hill et al. 1998)
US 6764696 Jul 2004	Effervescent drug delivery system for oral administration	A system that uses effervescence as a penetration enhancer where effervescence can occur within the oesophagus to maximise absorption	Cima Labs Inc. (Pather et al. 2004)
W 2004060346 Jul 2004	Drug delivery from rapid gelling polymer composition	A liquid composition that gels following administration for adhesion within the oesophagus	Angiotech Internat GMBH (Gravett et al. 2004)

1.3 Evaluation of Current Oesophageal Drug Delivery

Table 1.3: A summary of patents that relate to bioadhesive liquids for oesophageal drug delivery (Part 2)

Patent No.&Date	Title	Summary	Assignee
US 6916485 Jul 2005	Prolonged bioadhesive therapeutic systems	A prolonged release bioadhesive solid formulation to target mucosal surfaces.	Bioalliance Pharma (Aiache et al. 2005)
US 5855908 Jan 1999	Non-dissolvable dosage forms for use in the transmucosal delivery of a drug to a patient	A non-dissolvable matrix retained within the oral cavity for delivery of drug to the mouth, pharynx and oesophagus	University of Utah (Stanley & Hague 1999)
US 6316011 Nov 2001	End modified thermal responsive hydrogels	A thermally gelling pharmaceutical composition suitable for administration of a pharmaceutical agent across oesophageal mucosal membranes.	Madash, LLC (Ron et al. 2001)
US 6638521 Oct 2003	Oral liquid mucoadhesive compositions	A method of providing a mucoadhesive coating to mucosa of the oesophagus comprising from about 20% to about 50% by weight of the composition, of colloidal particles and a safe and effective amount of a pharmaceutical active	The Procter Gamble Company (Dobrozi 2003)
US2007111978 May 2007	Viscous budesonide for the treatment of inflammatory diseases of the GI tract	A viscous liquid composition that is directed to the treatment of inflammatory diseases involving the oesophagus	Dohill et al (2007)

1.3 Evaluation of Current Oesophageal Drug Delivery

formulation (Martins & Rex 1997). This mode of administration of a suspension intended for systemic absorption has not been fully exploited yet but the study indicates that local action plays a part in activity of the formulation.

The therapeutic activity of cyclodextrin-associated itraconazole oral suspension was compared in the treatment of oesophageal candidiasis in mice following delivery by two routes, oral and intragastric (Ishibashi et al. 2007). In the oesophageal candidiasis model, oral administration of itraconazole displayed superior therapeutic efficacy to the intragastric route. This is likely to be due to retention of relatively higher amounts of itraconazole on oesophageal tissue after oral administration of the suspension (Ishibashi et al. 2007)

Recent work using a topical viscous solution to treat eosinophilic oesophagitis has shown clinical efficacy (Aceves et al. 2005; Laine & Rabeneck 1995). The use of liquids to target the oesophagus has been well reported in the scientific literature although there is yet to be clinical uptake of these findings.

1.3.2.2 Gels and pastes

Orally retained gels and pastes are often for local treatment of conditions within the oral cavity. For example, Daktarin[®] gel is the therapy of choice for mild oral fungal infections, this has been used successfully for many years although the high doses and relatively short retention time within the oral cavity means that it is less effective compared to more sophisticated delivery systems. Chitosan, a polycationic polysaccharide, has been shown to demonstrate anti-fungal action *in vitro*. It was formulated with chlorhexidine as buccal gels or films for anti-fungal activity by prevention of *Candida* binding to the mucosal surface, where *in vitro* studies suggested that these formulations would provide sustained levels of drug compared to oral rinses (Senel et al. 2000). Incorporation of amphotericin into Orabase[®], an oral-mucosa adhesive paste resulted in sufficiently high salivary drug concentrations overnight to maintain therapeutic levels (de Vries-Hospers 1978). Other drugs that have been incorporated into Orabase[®] include lidocaine (Gaynor 1971), Kenalog (Kushner 1981), clobetasol (Lozada-Nur

1.3 Evaluation of Current Oesophageal Drug Delivery

et al. 1994), tacrolimus and 5-iodo-2'-deoxyuridine (Lozada-Nur & Sroussi 2006).

Similarly, incorporation into gels and pastes may be useful to deliver drugs to the oesophagus particularly for targeting fungal infections within the oesophagus.

1.3.2.3 Buccal tablets, patches and films

Formulations designed for buccal administration include erodible buccal tablets; bioadhesive buccal tablets; films and patches. Erodeable tablets are those that erode within the oral cavity releasing drug into the saliva and are intended for both local action and systemic delivery following uptake from the oral cavity and the GI tract once swallowed. Buccal films are flexible and have a larger surface area compared to tablets. Buccal patches and films are similar to tablets in their mechanism of release, yet are manufactured in different ways. These buccal formulations are generally manufactured with polymeric excipients that control the rate of drug release; these polymers may also have bioadhesive properties to retain the tablet/film within the oral cavity.

An orally erodible buccal formulation releases dissolved drug within the saliva providing an ideal means to treat local conditions including mucositis. The rate at which the device dissolves is dependant upon the formulation, with high molecular weight polymers providing sustained drug release. In addition, these formulations can be tailored to also target oesophageal infections with prolonged oesophageal transit and localised drug contact with the epithelial surface.

Buccal formulations have been extensively studied *in vitro* with bioadhesive strength often measured. Various anti-infective agents have been incorporated including miconazole (e.g. Nafee et al. 2003; Bouckaert & Remon 1993); clotrimazole (Khanna et al. 1996); and chlorhexidine (Carlo et al. 2006; Giunchedi et al. 2002; Senel et al. 2000).

An *in vivo* study compared a 10mg once daily mucoadhesive buccal tablet of miconazole with 400mg ketoconazole administered once daily for systemic uptake in

1.3 Evaluation of Current Oesophageal Drug Delivery

HIV-positive patients with oropharyngeal candidiasis. The results demonstrated that the low dose treatment *via* the buccal tablet was not statistically inferior to the systemic treatment and the local therapy was associated with a lower incidence of gastrointestinal disorders and drug-related adverse events (Van et al. 2004), demonstrating the advantages of advanced drug delivery over conventional systemic systems.

Several studies have compared the salivary concentrations of miconazole released from a buccal tablet to an oral gel. In all cases, the dose within the tablet was much lower than the gel although both are designed for release into the oral cavity and local action (e.g. Bouckaert et al. 1992; Mohammed & Khedr 2003).

Loramyc[®], a miconazole 50mg mucoadhesive gingival tablet, developed by BioAlliance Pharma, obtained its first marketing authorization in France in October 2006 for the treatment of oropharyngeal candidiasis in immuno - compromised patients including HIV patients and head or neck cancer patients undergoing radiotherapy. Salivary miconazole pharmacokinetics of the once daily 50mg bioadhesive eroding tablet (Lauriad[®], Bioalliance Pharma) were compared to those of a gel directly applied three times daily with a total dose of 375mg. Results demonstrated that salivary drug concentrations using the tablet were higher with prolonged duration above the minimum inhibitory concentration (MIC) required for therapy of some *Candida* species (Cardot et al. 2004).

1.3.2.4 Lozenges

Lozenges are tablets that dissolve or disintegrate slowly in the mouth to release drug into the saliva. They are easy to administer to paediatric and geriatric patients and are useful for extending drug form retention within the oral cavity. They usually contain one or more ingredients in a sweetened flavoured base. Drug delivery can be either for local administration in the mouth, such as anaesthetics, antiseptics and antimicrobials or for systemic effects if the drug is well absorbed through the buccal lining or is swallowed. Antifungal lozenges of amphotericin B and nystatin are currently commercially available intended for local therapy of

1.3 Evaluation of Current Oesophageal Drug Delivery

oral infections and are used in early stage therapy prior to systemic delivery of azoles.

Lozenges containing both miconazole and chlorhexidine have been developed and initial studies demonstrated that, in comparison to a proprietary oral gel formulation, the bioadhesive lozenges produced much more uniform and effective salivary levels of miconazole over a prolonged period (Codd & Deasy 1998).

An early-stage study comparing a single once daily fluconazole tablet (100mg) to 10mg clotrimazole troches (medicated lozenges) taken five times daily, found that fluconazole was more effective than clotrimazole troches in the treatment of HIV-infected patients with oral candidiasis (Koletar et al. 2003). However, the authors recognised that the ease of administration and dosage regime may be partly responsible for the superior results observed. Patients taking fluconazole (one capsule daily) were found to be uniformly compliant, however only two patients in the clotrimazole group, completely followed the treatment regimen (one troche five times daily) for the full 14 days as prescribed. Reasons for non-compliance included forgetfulness, the inconvenience of taking multiple doses, and altered taste sensations; this study highlights that as well as providing a lower dose the dosage regime needs to be considered as patient compliance is necessary for clinical efficacy.

Liquid-filled lozenges have previously been used in the treatment of sore throats, for example the Halls Soothers range of products. This technology has been further described in recent patents where the casing can control the rate of release of the internal liquid filling such that the casing remains as an empty shell and the liquid is entirely released before complete dissolution of the casing (Rivier 2007). Such a system may lend itself to oesophageal drug delivery where the outer casing can control both the rate of drug release and provide taste masking of the liquid drug-containing centre.

1.3 Evaluation of Current Oesophageal Drug Delivery

1.3.2.5 Orally disintegrating tablets (ODTs)

Orally disintegrating tablets are those that disintegrate rapidly (within 60 seconds) upon contact with saliva within the oral cavity releasing the drug into the saliva for rapid uptake or local action (note that these differ from orally erodible tablets in terms of the time scale for disintegration/dissolution, with orally eroding tablets providing sustained release over the longer timescale required for matrix erosion). The demand for fast-dissolving/disintegrating tablets or fast-melting tablets that can dissolve or disintegrate in the mouth has been growing particularly for those with difficulty swallowing tablets such as elderly and children, or those with oesophageal motility disorders. They are referred to using a range of terminologies: fast-dissolving, orodispersible and fast-melting and the FDA has adopted the term orally disintegrating tablets (ODTs).

Increased bioavailability using such formulations is sometimes possible if there is sufficient absorption *via* the oral cavity prior to swallowing (Codd & Deasy 1998; Habib et al. 2000). However, if the amount of swallowed drug varies, there is the potential for inconsistent bioavailability. Patented orally disintegrating tablet technologies include OraSolv[®], DuraSolv[®], Zydys[®], FlashTab[®], Wowtab[®] and others.

A fluconazole orally dispersible tablet (100mg once-daily) was prepared *via* microencapsulation of the drug to allow rapid dispersion of the drug and was found to be effective for the treatment of oropharyngeal candidiasis (Vandercam et al. 1998). The ODT fluconazole tablet was bioequivalent to the solid dosage form of fluconazole (capsule) yet the salivary concentration of the drug was 63 times higher with the ODT compared to the capsule (Vandercam et al. 1998).

Fast dissolving famotidine (20mg) wafers were compared to ranitidine tablets (150mg) to measure the early effects in the treatment of GORD. Results demonstrated that patients preferred the wafer to the tablet and that the wafer provided significantly better relief compared to the tablet during the first hour after dosing. At 120 and 180 minutes the degree of relief was similar for the two drugs

1.3 Evaluation of Current Oesophageal Drug Delivery

(Johannessen & Kristensen 1997).

Recent reports have described the feasibility of preparing fast-dissolving mucoadhesive microparticulate delivery systems to improve drug residence time on sublingual mucosa and improve drug dissolution rate (Cilurzo et al. 2005), such systems may be transferable to targeting the oesophagus.

1.3.2.6 Chewable tablets

Chewable tablets are designed to be mechanically disintegrated in the mouth. Potential advantages of chewable tablets mainly concern patient convenience and acceptance although enhanced bioavailability is also claimed. This increase in bioavailability can be due to a quick onset of action as disintegration is more rapid and complete compared to standard formulations that must disintegrate further down the GI tract. The dosage form is an appealing alternative for paediatric and geriatric consumers as well as those with oesophageal motility disorders. Chewable tablets are also desirable because they offer convenience for consumers, avoiding the necessity of co-administration with water, and creation of palatable formulations could increase compliance. A second advantage lies in the size of dose administered, chewable tablets can be much larger than conventional dosage forms allowing incorporation of larger dosages. A limitation with this system is that many pharmaceutical actives have an unpleasant bitter taste that can reduce compliance among patients.

Antacids are often formulated as chewable tablets designed for local action within the stomach rather than direct action on the oesophageal surface in GORD. Drawbacks of chewable antacid tablets often include the chalkiness and gritty mouthfeel of such products. A patent from the 1980's described a chewable tablet that liquefied within the oral cavity upon mastication leading to a product with a better mouthfeel (Valentine 1987). This technology could be transferred to oesophageal drug delivery *via* the formulation of such a system where the liquefied centre could target the oesophageal surface.

1.3 Evaluation of Current Oesophageal Drug Delivery

1.3.2.7 Chewable gums

Medicated chewing gum is a drug delivery system comprising a gum base with a pharmacologically active ingredient that can be used for local delivery within the oral cavity or for systemic absorption. Chewing gum offers advantages in that it can be taken without water (similar to oral liquids) yet possesses the stability and shelf life associated with solid dosage forms. In addition, the discrete nature and unit dose capabilities could also improve patient acceptability. Drugs that are intended for local action within the oral cavity may have low saliva solubility and chewing gum can assist in improving solubility and retention of the drug within the gum in the oral cavity, this can also be extended for action within the oesophagus. Disadvantages include the need for taste-masking of the active agent, this has been reported to be problematic with chlorhexidine which also stains the teeth and tongue (Addy & Roberts 1981).

Medicated gums for delivery of dental products to the oral cavity are marketed in a number of countries, e.g. fluoride-containing gums as an alternative to mouth-washes and tablets or chlorhexidine gum for treatment of gingivitis. The potential use of medicated chewing gums in the treatment of oral infections has also been reported. Gums have been prepared containing antifungal agents such as nystatin (Andersen et al. 1990) and miconazole (Bastian et al. 2004) or antibiotics, such as penicillin and metronidazole for the treatment of oral gingivitis (Emslie 1967).

Clinical trials that compared miconazole oral gel with miconazole chewing gum demonstrated that the gum was at least as efficient as oral gel in the treatment of fungal infections within the mouth, although very low doses of the drug were released from the chewing gum indicating greater efficacy was likely to be due to the retention of the formulation within the oral cavity (Bastian et al. 2004; Rindum et al. 1993). Analgesic-antibiotic chewing troches and chewing gums have been used in post-operative care of tonsillectomised patients, however, this is now inappropriate considering sensitisation and toxicology (Pavelic 1960). Chewing gums offer certain opportunities for delivery of drugs to the oesophagus in terms of antifungal agents or agents to protect against gastric reflux. The chewing gum

1.3 Evaluation of Current Oesophageal Drug Delivery

vehicle can act to both assist in solubilisation of the drug and prolonged exposure to the oesophageal surface as it is swallowed continuously over long periods of time.

Chewing gum has also been used in the treatment of GORD, the action of chewing stimulates the production of more bicarbonate-containing saliva and increases the rate of swallowing therefore enabling greater neutralisation of refluxed acid within the oesophagus. Wrigley launched Surpass chewing gum to treat reflux in 2001 however the product was withdrawn two years later with the company citing poor sales as the rationale for this product's withdrawal. There has been some debate about the benefits of swallowed saliva over the reduction in gastric pH brought about by chewing regular gum; however, when antacid chewing gums were compared to antacid chewable tablets it was demonstrated that the gums showed greater duration of relief (Collings et al. 2002).

Chewing gums that have a liquid centre have been described in recent patents, specifically one that contains calcium that may be used in the treatment of gastro-oesophageal reflux disease (Barreca 2005). As yet there are no data in the public domain demonstrating their use in targeting the oesophagus although this strategy may prove fruitful in the future, as seen in Table 1.4.

The incorporation of sildenafil citrate into chewing gums has been widely reported with Wrigley filing a patent on this formulation. This formulation seems likely to treat male impotence rather than oesophageal motility disorders. There may be some merit, however, in the evaluation of the smooth muscle relaxant effect on the lower oesophageal sphincter by sildenafil-containing chewing gum as a means of treating oesophageal motility disorders.

1.3.2.8 Luminaly delivered therapies bioadhesion

Endoscopic therapies for the control of oesophageal diseases offer the potential for significant symptomatic improvement while obviating many of the potential drawbacks associated with long-term medical therapy. Such endoluminal

1.3 Evaluation of Current Oesophageal Drug Delivery

Table 1.4: Patents that describe chewing gum formulations that may be applicable for the treatment of oesophageal diseases

Patent Number and Date	Title	Summary	Assignee
US 6663849 Dec 2003	Antacid chewing gum products coated with high viscosity materials	A chewing gum containing antacid that raises the viscosity of the saliva when the gum is chewed	Wm. Wrigley Jr. Company (Zyck et al. 2003)
US 6592850 July 2003	Sildenafil citrate chewing gum formulations and methods of using the same	Methods of treating oesophageal spasms, dysphagia, and gastroparesis utilising chewing gum formulations containing sildenafil citrate	Wm. Wrigley Jr. Company (Gmunder et al. 2003)
US 4684534 August 1987	Quick-liquifying, chewable tablet	This application discloses tablets having a harder outer shell which inhibits penetration of liquid into the interior of the tablet, and a softer interior which quickly liquifies when the tablet and shell are broken into pieces and contacted by the liquid.	Dynagram Corporation of America (Valentine 1987)

1.4 Experimental Methodology to Investigate the Potential of the Oesophageal Adhesion

therapies are intended to be safe, easily administered in an outpatient setting without the need for general anaesthesia, reproducible, and durable. These therapies have been most frequently used in the treatment of GORD. The different approaches can be roughly classified into three main categories; thermal methods with radiofrequency-energy delivery (Stretta procedure), endoscopic suturing with different sewing devices, and injection of inert biocompatible material (eg, polymethyl acrylate microspheres or ethynil vinyl acetate) or implantation of a prosthesis (Gatekeeper) at or above the cardia.

Botulinum toxin type A (Botox; Allergan,) has been used in different spastic disorders of the striated muscles when injected locally; emerging data suggest that botulinum toxin is also effective in treating smooth-muscle disorders of the GI tract (Yeh & Triadafilopoulos 2006).

1.4 Experimental Methodology to Investigate the Potential of the Oesophageal Adhesion

The focus of research in oesophageal drug delivery has been on *in vitro* evaluations to a greater extent than *in vivo* testing. The major disease states investigated have been fungal infections within the oesophagus and gastro-oesophageal reflux disease.

1.4.1 *In vitro* methods to assess oesophageal bioadhesion

A range of *in vitro* models have been reported in the literatures that assess bioadhesion in different ways. For solid dosage forms, force of detachment studies have been employed to assess adherence of films and tablets *in vitro* on dialysis membrane and pig cornea (Henriksen et al. 1996), on porcine oesophageal tubes (Honkanen et al. 2002), and filter paper hydrated with a mucin dispersion (Bonferoni et al., 2004). Llabot et al (2004) measured the force of detachment of a tablet from the surface of a 30% mucin gel. Varshosaz & Dehghan (2002) coated thin glass plates with a polymer solution, before drying them; these coated plates were attached to a tensiometer and dipped into 1% mucus or alginate solutions,

1.4 Experimental Methodology to Investigate the Potential of the Oesophageal Adhesion

and the force of detachment measured. Many bioadhesion measurements made under a controlled environment are difficult to extrapolate to performance *in vivo*, as the *in vitro* conditions are so different from the *in vivo* situation. The considerable discrepancies between studies are probably related to the different experimental conditions; Mortazavi and Smart (1995) therefore produced a tensiometer test in an attempt to standardise bioadhesion measurements (Mortazavi & Smart 1995), however this was for solid materials and there is no similar standard model for liquid retention. The adhesive properties of polymers are somewhat altered by hydration; Gurny et al (1984) and Mortazavi (1995) stressed that over-hydration can cause the formation of a slippery mucilage and loss of adhesive properties. The application of liquid bioadhesion, although desirable, is therefore a challenge in pharmaceutical development, particularly where conventional bioadhesive polymers are concerned, and a means for assessment of bioadhesive performance of a liquid is required. Models for assessing liquid bioadhesion have included an agar-coated glass tube, washed to mimic saliva flow (Ito et al. 1990). The polymers applied to the tube had been dyed, and the eluate was assayed colourimetrically. Park and Robinson (1985) performed a novel study of polymer binding to cultured cells (Park & Robinson 1985) where a fluorescent probe pyrene, localised in the lipid membrane, produced a fluorescent spectrum; the degree of change in fluorescence was proportional to binding of polymer to the cell membrane. Their study concluded that carboxylated polyanions were favoured polymers in terms of both bioadhesion and toxicity. Dobroszi and colleagues (1999) measured retention of commercially available sucralfate suspensions on rat oesophagus everted over a plastic rod. This dipping technique had the benefits of physiological temperature control and fluid movement over the tissue surface, but lacked peristaltic simulation and the amount of fluid available for contact was far greater than the saliva volume available in the oesophageal lumen *in vivo*. Richardson et al (2005) more recently adapted the tube-based model to measure alginate retention in the lumen of an oesophageal tube, but added the simulation of peristalsis by running a roller down the oesophageal tube accompanied by a volume of artificial saliva. Proportions of alginate remaining on the top, middle and bottom of the oesophagus were assessed, and photographs were taken to record the appearance of the remaining tissue sections. This method was

1.4 Experimental Methodology to Investigate the Potential of the Oesophageal Adhesion

used to determine whether an alginate suspension composition could be altered to manipulate adhesion specifically to the distal oesophagus.

1.4.1.1 A comparison of the reported *in vitro* adhesion within the oesophagus

Despite the range of studies used to measure oesophageal retention *in vitro*, there are relatively few studies that measure the retention across a range of formulations. From Table 1.5 to Table 1.7, it describes the variety of tests used and lists the merits and limitations of each test.

1.4.1.2 Apparatus used in *in vitro* oesophageal adhesion studies

A flow model has been used most frequently to determine liquid oesophageal retention *in vitro*. This technique is robust and can differentiate, *in vitro*, between a range of formulations (Batchelor 2005). A more recent model described by Richardson et al also incorporates peristalsis that further improves the physiological relevance of this apparatus in determining oesophageal adhesion (Richardson et al. 2005). Figure 1.1, Figure 1.2 and Figure 1.3 illustrate the differences in apparatus used to measure oesophageal retention/adhesion *in vitro*, the saliva flow and physical motion present *in vivo* are complex and can be difficult to mimic *in vitro*. Saliva flow is included in most models affording the ability to alter the composition of the washing medium used to mimic saliva flow. This can also provide information on the adhesive interaction on the oesophageal surface. The everted oesophagus models are aggressive models in terms of saliva flow, therefore retention on such models is likely to provide an overestimation of that present in the *in vivo* situation.

1.4.1.3 Comparison of *in vitro* used to measure oesophageal adhesion of liquids

A comparison of the reported bioadhesive potential of a range of liquid formulations was discussed by Batchelor (2005) with variability in adhesion ranging from 5% retained after 10 minutes for Antepsin[®] and Ulcogant[®] on everted rat

1.4 Experimental Methodology to Investigate the Potential of the Oesophageal Adhesion

Table 1.5: A comparison of the tests available to measure oesophageal retention *in vitro*; Part 1; to be continued

Method Used	Advantages	Disadvantages	Analytical method used to quantify adhesion	Polymers/formulations measured
Agar-coated glass tube washed to mimic saliva flow to test magnetic systems (Ito et al. 1990a)	Simple, rapid, and reproducible <i>in vitro</i> model	Limited physiological relevance to the mucosal surface; peristalsis was not mimicked; quantification of adhesion was indirect	Colorimetric <i>via</i> a dye incorporated into the polymer solution	Hydroxypropyl cellulose (HPC) and Carbopol 934® (6:4 w/w)
Cultured epithelial cells providing a mucin-epithelial surface (Park & Robinson 1985)	Simple, rapid, and reproducible <i>in vitro</i> relevant surface	No washing to represent the physical issues surrounding bioadhesion; peristalsis was not mimicked; quantification of adhesion was indirect	The change in fluorescence of the epithelial cell layer adhesion	Copolymer of acrylic and methacrylic acid
Flexible polyethylene tube washed to mimic saliva flow (Vonarx et al. 1997)	Simple, rapid, and reproducible <i>in vitro</i> model; the tube was held vertically to mimic the oesophagus	Limited physiological relevance to the mucosal surface; peristalsis was not mimicked; quantification of adhesion was indirect	Colourimetric <i>via</i> a dye incorporated into the polymer solution	Polycarbophil, xanthan gum, poloxamer and sodium carboxymethyl-cellulose

1.4 Experimental Methodology to Investigate the Potential of the Oesophageal Adhesion

Table 1.6: A comparison of the tests available to measure oesophageal retention *in vitro*; Part 2; to be continued

Method Used	Advantages	Disadvantages	Analytical method used to quantify adhesion	Polymers/formulations measured
Everted rat oesophagus dipped into adhesive formulations then washed in relevant media (Dobrozsi et al. 1999)	Simple, rapid, and reproducible <i>in vitro</i> model; relevant mucosal surface; the tissue was vertically to mimic the oesophagus	Rat oesophageal tissue is very different to human oesophageal tissue; peristalsis was not mimicked; quantification of adhesion was indirect	The adhesive material was radiolabelled and this was used to determine	Marketed sucralfate suspensions (Gastrogel [®] , Antepsin [®] , and Ulcogant [®])
Porcine oesophageal tissue with washing to mimic saliva flow (Batchelor et al. 2004; Jolliffe, & Craig 2004; Batchelor et al. 2002; Batchelor 2005; Richardson et al. 2005; Smart et al. 2003; Tang et al. 2005)	Simple, rapid, and reproducible <i>in vitro</i> model; relevant mucosal surface; the tissue could be angled to mimic the oesophagus	Peristalsis was not mimicked; quantification of adhesion was indirect	The adhesive material was either radio or fluorescently labeled and this was used to determine adhesion	Polyacrylic acids, alginates, fluorescent particles, Gaviscon [®] , Noveon AA, Antepsin [®] , glycerol, Smart hydrogel

Table 1.7: A comparison of the tests available to measure oesophageal retention *in vitro*; Part 3

Method Used	Advantages	Disadvantages	Analytical method used to quantify adhesion	Polymers/formulations measured
Microscope slides coated in agar then dipped into polymeric solutions (Potts et al. 1997)	Simple, rapid, and reproducible <i>in vitro</i> model;	Limited physiological relevance to the mucosal surface and no washing effects; peristalsis was not model; adhesion was indirect	Gravimetric analysis of polymer collected on the surface of the coated microscope slide	Smart hydrogel (thermogelling polymer), Carbopol®934P HPMC
Everted porcine oesophageal tissue attached to a USP disintegration apparatus (Richardson et al. 2004)	Simple, rapid, and reproducible <i>in vitro</i> model; relevant mucosal surface; the tissue was held vertically to mimic the oesophagus	Peristalsis was not mimicked; quantification of adhesion was indirect	A polymer-dye colourimetric complexation assay	Alginate suspensions
Porcine oesophageal tissue with washing to mimic saliva flow and peristalsis (Richardson et al. 2005)	Simple, rapid, and reproducible <i>in vitro</i> model; relevant mucosal surface; the tissue could be angled to mimic the oesophagus, peristalsis was mimicked	Quantification of adhesion was complex	A polymer-dye colourimetric complexation assay	Alginate suspensions

1.4 Experimental Methodology to Investigate the Potential of the Oesophageal Adhesion

1.4 Experimental Methodology to Investigate the Potential of the Oesophageal Adhesion

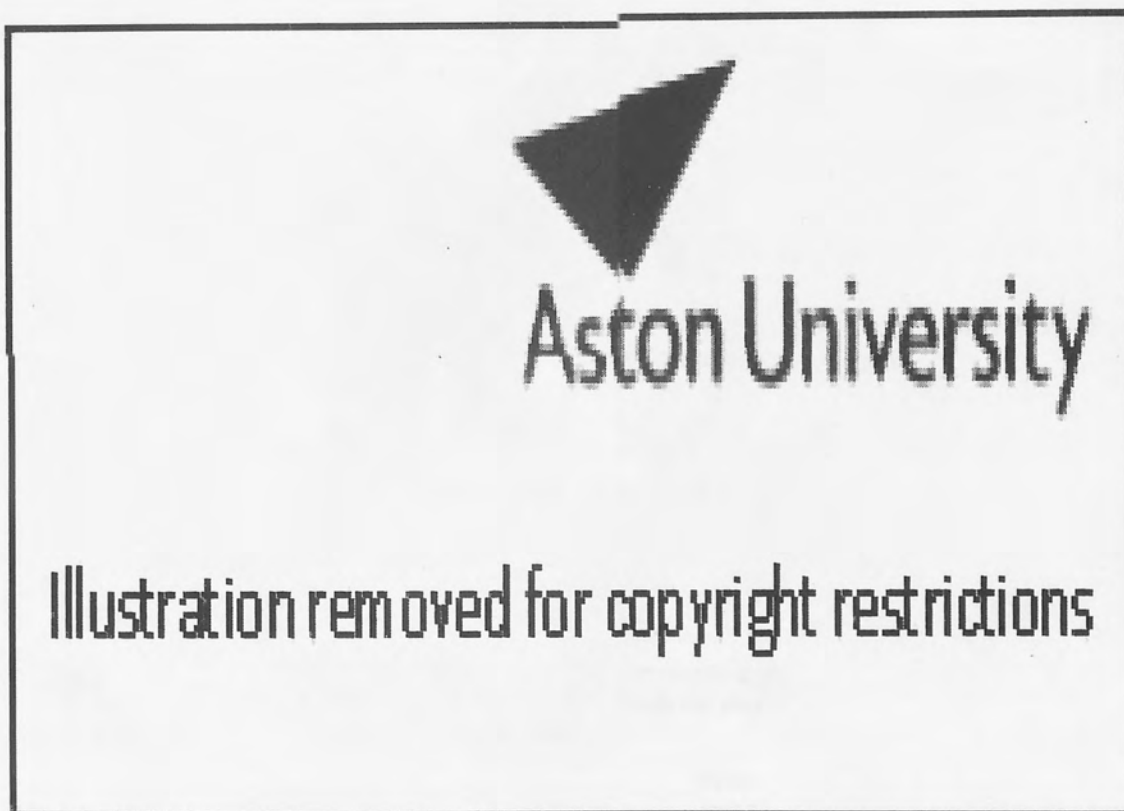

Figure 1.1: Details of the apparatus used for the *in vitro* measurement of oesophageal retention: the everted rat oesophagus model (Dobrozsi et al. 1999)

1.4 Experimental Methodology to Investigate the Potential of the Oesophageal Adhesion



Figure 1.2: Details of the apparatus used for the *in vitro* measurement of oesophageal retention: the flow model (Smart et al. 2003)

oesophageal tissue yet greater than 90% of an applied dose of Carbopol®934P retained after 10 minutes on an agar substrate. Both the nature of the formulation and the substrate therefore affect the retention measured. It has generally been water soluble or water swellable polymers that have been postulated as potential adhesives where the interpenetration and water motion are responsible for the adhesion demonstrated. Batchelor (2005) provided data that compared a range of these polymers using the same test, the flow model that examined retention on porcine oesophageal tissue. Figure 1.4 illustrates the results of this investigation.

The information from Figure 1.4 suggests that only a small fraction of the applied dose is retained on the oesophageal surface after ten minutes of washing. There was some correlation of viscosity with retention although this was not considered to be the most important factor as illustrated by the similarity in retention profiles observed for water (with a very low viscosity) and glycerol that has a higher viscosity. This result demonstrates that *in vitro* models are useful to evaluation the adhesion of a range of polymers in terms of bioadhesion as part of a screening exercise.

1.4 Experimental Methodology to Investigate the Potential of the Oesophageal Adhesion



Figure 1.3: Details of the apparatus used for the *in vitro* measurement of oesophageal retention: the flow model that has been adapted to include peristalsis (Richardson et al. 2005)

1.4 Experimental Methodology to Investigate the Potential of the Oesophageal Adhesion



Illustration removed for copyright restrictions

Figure 1.4: A comparison of the percentage of an applied formulation retained on porcine oesophageal tissue after 10 minutes of washing with artificial saliva. This figure is taken from Batchelor (2005).

1.4.2 Techniques used to observe oesophageal transit *in vivo*

Traditionally oesophageal transit and function has been measured with manometry or barium radiography. Manometry has developed from simple low channel versions where the pressures in the distal and proximal sphincters were measured, to high resolution, coupled with computer-generated graphics, providing a much more detailed and complex image, which allows for detailed analysis of the physiology of peristalsis and sphincter function. Magnetic marker monitoring has also been used to track oesophageal transit although this technique is only really useful to monitor the transit of solids rather than liquids (Weitschies et al. 1999).

Radiographic studies with barium contrast have traditionally been used to screen for motility disorders of the oesophagus although these techniques have occasionally been combined with manometry to quantify parameters of sphincter function. Bolus transport is of primary interest in determining adhesion within the oesoph-

1.4 Experimental Methodology to Investigate the Potential of the Oesophageal Adhesion

agus for local drug delivery and scintigraphy is the only method that measures this directly. However, multichannel intraluminal impedance (MII) can measure bolus transport indirectly *via* lumen dilation during bolus passage. MII is a technology that allows detection of bolus movement within the oesophagus without the use of external radiation or radiolabeled substances. The principles of MII are based on changes in resistance to alternating electrical current (impedance) induced by the presence of various boluses within the oesophagus. This technique can be used in combination with manometry to provide simultaneous information of intra-oesophageal pressure and bolus transit; it can also provide some information on the chemical characteristics of the bolus material. MII devices have now been made portable with external power supplies to improve patient comfort (Ativanichayaphong et al. 2007). However, this technique does require the patient to wear an intra-oesophageal probe during collection of data which may interfere with the resulting data.

1.4.2.1 Gamma Scintigraphy

Gamma (γ)-scintigraphy provides an extremely valuable non-invasive method of acquiring information about formulation transit under physiological conditions (Newman et al. 2003; Teran et al. 2005; Wilding et al. 2001; Wilson et al. 1997). The quantity of radioactive material required to be incorporated into a formulation to make it suitable for scintigraphy assessment is very small, and should not affect the performance characteristics of the system (Wilding et al. 2001). Technetium 99m (Tc99m) is often selected as the radiolabel for scintigraphic studies due to its short half life (6 hours), versatile chemistry, and near ideal energy (140 keV) (Wilding et al. 2001). A disadvantage of gamma scintigraphy in the evaluation of adhesion/retention of liquids within the oesophagus is the use of a radiochemical agent as a model component to measure adhesion; it is generally assumed that the label remains associated to the vehicle and it is important that this assumption is validated for accurate interpretation of data. A recent review highlighting this issue refers to the need for realistic labels for many imaging techniques and includes discussion on the adaptation of polymers to enable direct measurement (Kim et al. 2007).

1.4 Experimental Methodology to Investigate the Potential of the Oesophageal Adhesion

Scintigraphic methods have been used to evaluate the intra-gastric disposition of alginate (Washington et al. 1993), intra-ocular and intra-gastric carbomer retention (Jackson et al. 2001; Wilson et al. 1998), and oesophageal retention of Smart Hydrogel[®] (Potts et al., 1997). The clearance of acid and bile from the oesophagus was investigated *via* injection of radiolabelled liquids into the distal oesophagus and visualisation of their clearance *via* gamma scintigraphy (Koek et al. 2004); this method demonstrated that gamma scintigraphy can be used to track the motion of small volumes of fluid within the oesophagus.

The application of gamma scintigraphy to visualise oesophageal adhesion of solid dosage forms, particularly for formulations that become lodged within the oesophagus, has been widely reported (for example Perkins et al. 1994; Wilson et al. 1988), however there are relatively few studies that measure the adhesion of liquids within the oesophagus for therapeutic advantages.

One example study that used gamma scintigraphy to observe solid particles (granules of chitosan, released when a gelatine capsule that was lodged in the oesophagus disintegrated) retained within the oesophagus for a prolonged period of time, was performed by Sakinnen et al (2004); the retention was likely to be due to the hydration of particles on the oesophageal surface enabling extended contact (Sakinnen et al. 2004).

Recently the effect of viscosity on pharyngeal retention of liquids was measured using gamma scintigraphy; this technique enabled differences in the retention of a range of materials to be determined although no significant difference in retention according to viscosity was observed (Bogaardt et al. 2007). The methodology used in this study could be adapted to measure retention within the oesophagus with small volumes of liquids.

1.4.2.2 Clinical X-ray

In a clinical situation, oesophageal transit may be assessed by an X-ray study of a swallowed suspension of barium sulphate. However, barium is dense and may

1.4 Experimental Methodology to Investigate the Potential of the Oesophageal Adhesion

have a faster transit than most physiological substances. An additional problem with this method is the high radiation dose associated with an X-ray study. There are no reported studies that measure oesophageal adhesion/retention of liquids using X-ray as a detection system.

1.4.2.3 Endoscopic visualisation

Direct visualisation of the oesophageal mucosa is performed *via* endoscopic examination; this is routinely used in clinical practice to observe damage to the oesophageal surface most commonly due to GORD. A recent study used endoscopic examination to visualise the presence of a bioadhesive hydrogels *in vivo*, a blue dye was incorporated into these hydrogels to allow simple visualisation (Collaud et al. 2007). This method used a blue dye that showed good contrast to oesophageal tissue and was able to demonstrate adhesion on the surface, however, no formulation was retained for greater than 10 minutes *in vivo* (Collaud et al. 2007).

The Pillcam ESO video capsule (Given Imaging, Yoqneam, Israel), is a novel dual-camera wireless capsule endoscope developed specifically for oesophageal visualization. This has shown some potential in visualisation of the oesophageal surface although it is less sensitive than traditional endoscopy for detection of Barrett's oesophagus but may be useful in patients unwilling or unable to undergo conventional endoscopy (Lin et al. 2007).

1.4.2.4 Impedance planimetry

Using impedance planimetry, the cross-sectional area of the oesophagus can be measured. This technique has been advanced to produce the functional lumen imaging probe (FLIP) for studying the distensibility and opening characteristics of the oesophago-gastric junction and, in contrast to any other medical imaging technology, FLIP is capable of providing quasi-3D lumen geometry in real time. This technique has been widely used in the determination of the biomechanical properties of the oesophagus (e.g. Rao et al. 1995; Zhao et al. 2007). A recent patent states that this technique can be used to develop a medical measurement

1.4 Experimental Methodology to Investigate the Potential of the Oesophageal Adhesion

tool to evaluate organ function. This tool could account for the volume and properties of a fluid, for example refluxed acid within the oesophagus as well as the level to which this liquid extends (Gregersen et al. 2006). This technology may therefore be transferable to the measurement of the retention of fluid within the oesophagus as adhesive drug delivery vehicles.

1.4.2.5 Endoscopic ultrasound

Endoscopic Ultrasound (EUS) is a imaging modality that combines the endoscopic view and the ultrasound picture. EUS enables visualisation of the mucosal surface of the GI tract as well as the individual wall layers, adjacent organs and other structures. New echo-endoscopes can be connected to modern ultrasound machines with advanced software making it possible to use different ultrasound modalities (B-mode, M-mode, Doppler, sonoelastography, strain rate imaging, 3D-imaging, contrast-enhanced ultrasound). This technique has previously demonstrated a three dimensional view of the oesophagus and it would therefore be valuable in assessing the *in vivo* potential of oesophageal-adhesive drug delivery systems (Hunerbein et al. 1997). Three-dimensional ultrasonography has been used to measure volumes within the stomach (Gilja et al. 1994) and has been validated *via* magnetic resonance imaging (MRI) however this was limited to small volumes and was not able to fully image the stomach. However, if this technique was applied to the oesophagus, it may be capable of monitoring liquid retention within this organ. Liquid emptying from the stomach was measured *via* ultrasonographic determination of gastric dimensions with a single section of the stomach and this technique may be transferable to the oesophagus.

1.4.2.6 Magnetic resonance imaging (MRI)

A recent study evaluated the feasibility of non-invasive dynamic fast magnetic resonance imaging (MRI) during swallowing in healthy volunteers, to determine oesophageal function at the gastroesophageal junction. The results indicated that dynamic MRI swallowing was a feasible and reproducible technique that warranted further studies in patients (Kulinna-Cosentini et al. 2007). The oesophageal transit of a range of liquid and gel formulations was measured by Potts

1.4 Experimental Methodology to Investigate the Potential of the Oesophageal Adhesion

et al (2000) by MRI to provide detailed anatomical images although quantification of the volume cleared per unit time was complex therefore scintigraphy is likely to remain the technique of choice. Scintigraphy is likely to remain the technique of choice in visualisation of the oesophagus as this offers a dynamic insight into swallowing and retention thereafter within the oesophagus, the development of advanced materials to enable direct detection will further enhance the potential of scintigraphy.

1.4.3 *In vitro-in vivo* correlation of oesophageal adhesion

Potts et al (1997) reported a biphasic clearance of a formulation from the oesophagus *in vivo* measured using gamma scintigraphy and this biphasic profile is present in many *in vitro* models of oesophageal retention (Batchelor et al. 2002; Richardson et al. 2005; Smart et al. 2003). Approximately 15% of the applied dose of Smart Hydrogel® (a thermogelling polymer) displayed prolonged retention in the *in vivo* model (Potts et al. 1997); this value is higher than corresponding *in vitro* models (Batchelor 2005).

Collaud et al (2007) compared the bioadhesive potential of a range of hydrogels (poloxamer, polyacrylic acid and chitosan) *in vitro* using rat oesophageal tissue and a flow methodology to human *in vivo* retention visualised *via* endoscopic examination; good correlation was noted between these two techniques. McCarger et al (2001) compared the *in vitro* adhesion of solid dosage forms to porcine oesophageal tissue with *in vivo* adhesion measured *via* gamma scintigraphy; the results demonstrated that the *in vitro* model was not predictive of the *in vivo* results (McCargar et al. 2001).

It is important to ensure that the *in vitro* methodology used is appropriate for the *in vivo* application of the dosage form and that the limitations with *in vitro* models are appreciated when considering correlations.

1.5 Further Challenges and Innovations in Oesophageal Drug Delivery

1.5.1 Mucoadhesive/bioadhesive system

To appreciate the potential of mucoadhesive use in oesophageal drug delivery, it is important to be aware of the nature of mucoadhesion. Bioadhesion can be described as the attachment of a synthetic or natural macromolecule to a biological tissue. The adhesive bond may form with either the epithelial surface, the continuous mucus or a combination of the two. In pharmaceutical terms, the objective of mucoadhesion can be defined as attachment of drug delivery applications to mucus or mucous membranes; and mucoadhesives can be defined as natural or synthetic materials used in drug delivery systems that lead to mucoadhesion.

The oesophageal mucosa is an ideal site for mucoadhesive drug delivery. The internal mucosal surface of the oesophagus is a moist surface covered with a layer of stratified squamous epithelium. A candidate mucoadhesive polymer should possess certain physicochemical features including hydrophilicity, numerous hydrogen bond-forming groups, and flexibility for interpenetration with both the unstirred surface layer and epithelial tissue and viscoelastic properties upon hydration (Sudhakar et al. 2006). Moreover, an ideal mucoadhesive carrier should be easily combined with drugs, to provide sufficient control over drug release. To achieve localised delivery to the oesophagus, it is important to understand the mucoadhesive mechanism of the selected carrier and identify the factors controlling mucoadhesion to produce the most effective system.

Many theories have been proposed to describe the mechanisms and forces involved in mucoadhesion. However, it is unlikely that a single, universal theory will account for all types of adhesion. However, there are three steps or processes that describe how the dosage form is attached, and the factors that affect the mucoadhesion can be examined independently during these three steps (Duchene & Ponchel 1992).

1.5 Further Challenges and Innovations in Oesophageal Drug Delivery

At first, the mucoadhesive needs to initiate intimate contact with mucosal surface by wetting and swelling. In the intimate contact step, the hydration of the mucoadhesive polymer is required to create hydrogen bonds (e.g. polyacrylates) and/or ionic bonds (e.g. chitosan) between the polymers and the mucosa. However, this hydration (swelling) can be affected by the hydrogen bonding capacity of the functional groups in the polymer and the extent of cross-linking within the polymer network. Park and Pobinson (1987) indicated that, for mucoadhesion to occur, the ideal polymers should have a considerable amount of functional groups that are able to form hydrogen bonds; furthermore, they believed that the flexibility of the polymer chains was important for effective hydrogen bond formation. Increasing the flexibility of poly (acrylic acid) hydrogels *via* tethering of long poly(ethylene glycol) (PEG) chains has demonstrated improved mucoadhesion due to this structural alteration. Moreover, results showed that using cross-linked polymers can improve the adhesion to the mucosa (Bures et al. 2001; Huang et al. 2000). The intimate contact between mucus membranes and bioadhesive depends on the spreading ability of the polymers (Lehr et al. 1992). This spreading ability is predicted by interfacial tension (Patel et al. 2006) and controlled by structural similarity (Accili et al. 2004) and degree of cross-linking (Warren & Kellaway 1998) of the adhesive polymer. When investigating the swelling and adhesion of a drug-polymer suspension for oesophageal delivery, Richardson et al (2004) demonstrated that a sodium alginate suspension in contact with the oesophageal mucosa resulted in a prolonged retention time. Furthermore, it was also suggested that the swelling and adhesion behaviour of the polymeric particles in the mucoadhesive system could be controlled by using different suspension vehicles (Richardson et al. 2005).

Secondly, as mucoadhesion occurs, the chains of the polymer interpenetrate and entangle into the unstirred water layer to create a larger contact area. This can be also described in two stages: the physical entanglement of the flexible polymer chains; and the interpenetration of components of the unstirred water layer into the porous structure of the polymer substrate. Sufficient depth of interpenetration and entanglement can create a semi-permanent adhesive bond. The

1.5 Further Challenges and Innovations in Oesophageal Drug Delivery

penetration rate is based on the diffusion coefficient of the polymer which is associated with its molecular weight (Sandri et al. 2004) and cross-linking density (Abrahams & Ronel 1975), and also is influenced by some important parameters such as segment mobility, flexibility of bioadhesive polymer, mucus glycoprotein and expanded nature of both networks.

Although traditionally pharmaceutically acceptable hydrophilic polymers have been used to demonstrate bioadhesion to a surface, the real situation is far more complex with adhesion dependant upon the structure and composition of the mucosa (e.g. the degree of keratinisation and the carbohydrate moieties expressed on the mucosal surface) (Accili et al. 2004). For example the mucoadhesive polymer could be chosen on the basis of internal as well as terminal sugars of the glycoconjugates present on the mucosal surface. Finally, attraction and repulsion in entangled chains and the weak chemical bonds formed between the mucoadhesive polymers and the mucus glycoproteins on the mucosal surface could be used to rank adhesive polymers. In this situation, Sigurdsson et al 2006 demonstrated the potential of mucoadhesive bonding formed after polymer spreading on the mucosal surfaces; and reported that unionized amino- and carboxyl groups on polymers were the important structural feature for the formation of weak chemical bonds to mucus glycoproteins; it indicated that the mucoadhesion was related to the ionization state of the ionisable polymers.

Conversely, for the basic viscosity-enhancing unionized polymers, such as hydroxypropyl methylcellulose (HPMC), mucoadhesion was most dependent on the swelling and hydration of the polymers, rather than the surface energy properties which describe the interpenetration and interaction with mucus layers.

The development of thiolated polymers have been heralded as a new generation of mucoadhesive drug carrier systems. The thiolated polymers, which are also called thiomers, are based on the hydrophilic polymers synthesised with thiol groups on their side chains. The advantages of the thiolated polymers are the strongly mucoadhesive behaviour resulting from disulphide bonds formed with cysteine-rich subdomains of mucus glycoproteins covering mucosal membranes

1.5 Further Challenges and Innovations in Oesophageal Drug Delivery

(Lim et al. 2002). By immobilization of thiol groups, the mucoadhesive properties of poly (acrylic acid) and chitosan were improved 100-fold to 250-fold (Allen et al. 1999).

1.5.2 Characterisation of the oesophageal surface layer

Resident on top of the oesophageal epithelial layer is an unstirred water layer, although notably very little information is available on the characterisation of this layer. The unstirred water layer has been estimated as being approximately $30\mu\text{m}$ thick (Attwood 1994) although other studies suggest a larger barrier of $95\pm 12\mu\text{m}$ using dark field inverted microscopy techniques (Sarosiek et al. 1993). Studies of the pH of the unstirred layer using microelectrodes have shown a luminal to cell surface pH gradient of pH 3.2 - 4.8 (Quigley & Turnberg 1987), which is not consistent with the normal luminal pH of 6.0 in the oesophagus (Edwards 1984). Although this resident protective barrier is termed an unstirred water layer, it is not composed of water alone.

Submucosal glands present in the oesophageal epithelium secrete many substances that may be contained within this layer. Materials from swallowed saliva may also be present. Submucosal glands secrete directly into the oesophageal lumen and it is from this site that fluids have been collected and assayed to determine the specific secretory products of the glands. It was shown that the submucosal glands secrete water, electrolytes (including bicarbonate ions), mucin, epidermal growth factor and prostaglandins (Long & Orlando 1999). These secretory products play a role in protection of the oesophagus. Bicarbonate ions act to neutralise any acid that is refluxed into the oesophageal cavity, while mucins aid in building a gel-like layer that protects against larger molecules such as pepsin *via* a physical diffusion barrier. Myers & Orlando 1992 examined the secretion of bicarbonate from human submucosal glands *in vivo*; both vagal stimulation and oesophageal acid perfusion were found to stimulate secretion of bicarbonate ions. A second source of bicarbonate ions present in the unstirred water layer may be derived from swallowed saliva. The secretion of mucin from the oesophageal submucosal glands has been investigated (Namiot et al. 1994b).

1.5 Further Challenges and Innovations in Oesophageal Drug Delivery

The results show that mucin is released at a rate of $0.23 \pm 0.03 \text{ mg/cm}^2/\text{min}$, this rate being relatively constant for a period of approximately 8 minutes. The authors analysed the material present in the oesophageal lumen and assumed it was derived from oesophageal secretions. They also suggested that the mucin detected was structurally distinct from both salivary and gastric mucin. Their study used a Periodic acid-Schiff (PAS) assay to detect and quantify glycoprotein as an indication of mucin levels, however, it should be noted that there are many other PAS positive substances present in human oesophageal epithelium (Long & Orlando 1999).

More recently, Accili et al (2004) histologically characterised oesophageal mucosa and compared this to sublingual and duodenal bovine tissue samples. PAS and Alcian blue staining exhibited weak reactivity in oesophageal mucosa suggesting that there are limited amounts of glycoconjugate components rich in neutral and acidic radicals. Further characterisation of glycoconjugate composition was performed *via* lectin histochemistry that revealed amounts of β -galactose, sialic acid β -galactose, C4 sialic acid β -galactose, N-acetyl-D-galactosamine, sialic acid N-acetyl-D-galactosamine, C4 sialic acid N-acetyl-D-galactosamine, α -2,6-sialic acid β -galactose, α -2,3-sialic acid β -galactose, D-mannose (Accili et al. 2004). This characterisation of the oesophageal mucosa provides information that can be used in the design of specific adhesives to target this organ. The use of lectins that specifically target the sugars present on the oesophageal mucosa provides a mechanism for specific organ targeting. The use of lectins that specifically target O-substituted sialic acids (e.g. *Cancer antennarius* and *Achantina fulica*) may provide one strategy to enhance specificity in oesophageal targeting (Accili et al. 2004).

1.5.3 Magnetic targeting

Magnetic particles coated with a bioadhesive polymer were proposed for targeting the oesophagus *via* the use of an external magnet placed over the oesophagus (Ito et al. 1990). Magnetic monitoring has been already used in different applications

1.5 Further Challenges and Innovations in Oesophageal Drug Delivery

such as investigation of the motility of the human digestive system and it is possible to track a magnetic particle through the GI tract of the human body (Richert et al. 2005). Once a magnetic capsule can be localised within the digestive system, it would be useful to develop a simple procedure for releasing the drug at a desired position. Usually, active drug release systems achieve drug release by melting parts of a capsule due to heating by eddy current or magnetisation losses (Richert et al. 2005).

1.5.4 Modulation of adherence

Adhesion of micro-organisms, such as *Candida albicans*, is the first step in the establishment of infection; therefore, prevention of this step is a strategy in reducing infection incidence. The adhesion properties of antimicrobial agents has been examined at very low (sub-MIC) concentrations (Barembaum et al. 2003; Gorman et al. 1987; McCarron et al. 2004; Tobgi et al. 1987). Other studies have coated surfaces with bioadhesive polymer as a means of modulating *Candida* adherence; Barembaum et al (2003) examined sodium alginate and chitosan as agents to prevent the first stage adhesion and thus combat infection. They found that these agents had *in vitro* MIC values of 0.1%w/v and 0.25%w/v respectively. The use of non-drug loaded polymeric nanoparticles to disrupt microbial adherence was measured *in vitro* using buccal epithelial cells with a reduction in adherence observed. This may be a future direction for prophylaxis of candidiasis of the oral cavity (McCarron et al. 2004).

1.5.5 Modelling the oesophagus to design an adhesive coating

The peristaltic transport of swallowed material in the oesophagus is a neuromuscular function involving the nerve control, bolus-structure interaction, and structure-mechanics relationship of the tissue. A finite element model (FEM) has been developed that simulates food transport through the tissue (Yang et al. 2007). There are three components of this model; tissue, food bolus and peristaltic wave, and it is these components as well as the interactions between them

that are key to the model. The model was able to capture the main characteristics in the intraluminal pressure and bolus geometry as measured experimentally (Yang et al. 2007), therefore this model could be used to further explore the mechanism of oesophageal transport in various clinical applications including the flow of an adhesive liquid within the oesophagus.

An analytical tool has been developed that can be used to analyze the mechanics of bilayered organs (such as the oesophagus) *via* determination of the conductivity of the fluid in the lumen and thereby determine the parallel conductance of the wall and geometric and mechanical properties of the organ wall. There are two immediate implications of the results in this study for the understanding of oesophageal function and for clinical practice (Fan et al. 2004). This model may be further adapted to look at these stress-strain relationships to predict fluid flow through this organ. In addition, the effect of peristalsis on materials has also been examined.

1.5.6 Artificial lower oesophageal sphincter

An endoscopically implantable device that stimulates the lower oesophageal sphincter on demand has been tested in dogs as a novel therapeutic approach to gastroesophageal reflux disease, and may have therapeutic potential for other gastrointestinal motility disorders (Clarke et al. 2007). A magnetic device that can act as a high pressure zone in a model of the oesophagus has also been investigated *in vitro*, this technology may be of use *in vivo* although no studies reporting this are available as yet (Bortolotti 2006).

1.6 Aims and Objectives

The aim of this thesis is to investigate the *in vitro* potential of mucoadhesive drug delivery systems designed to target the oesophagus for the delivery of antifungal agents in the treatment of oesophageal candidiasis. The bioadhesive liquid dosage form and orally retained films and tablets will be developed according to the physicochemical properties of model drugs. Orally retained dosage forms

1.6 Aims and Objectives

will be evaluated to measure concomitant drug and polymer release as this will provide solubilised drug within a viscous matrix to the surface of the oesophagus to maximise contact.

The objectives are:

- To use *in vitro* techniques to measure the bioadhesive potential of liquid formulations targeting the oesophagus
 - ✓ To measure *in vitro* efficacy of bioadhesive liquids containing miconazole nitrate as a formulation to targeting oesophageal infection
- To manufacture solid oral dosage forms for retention within the oral cavity
 - ✓ To evaluate physical mechanical properties of film formulations
 - ✓ To measure *in vitro* drug dissolution from solid formulations
 - ✓ To quantify polymer dissolution from orally retained solid dosage forms
 - ✓ To mathematically model release profiles from solid dosage forms using existing models and compare the theoretical release to the experimental release mechanisms observed
 - ✓ To measure the *in vitro* potential of orally retained solid dosage forms designed to target the oesophagus
- To develop novel chewable dosage forms containing an antifungal agent designed to target the oesophagus
 - ✓ To compare the dissolution of both drug and polymer from chewable formulations using a range of dissolution methods
 - ✓ To relate the dissolution method used to the release mechanism observed for chewable formulations
 - ✓ To provide an overview of the range of dosage forms available to target the oesophagus and the *in vitro* characteristic of each of these dosage forms

Chapter 2

Bioadhesive Liquids for Oesophageal Drug Delivery

2.1 Introduction

The limited use and success of topical agents (eg. antifungals) in the treatment of oesophageal diseases (eg. infections) has several underlying causes: the need for frequent daily dosing, insufficient contact time between drug and mucosal surface, lack of saliva, poor patient compliance due to unpleasant taste and insufficient therapeutic efficacy. Bioadhesive drug delivery devices offer prolonged drug retention and thus enhanced absorption with increased overall bioavailability. This advantage has led to much research into bioadhesion and many studies have been performed that investigate the adhesive potential of formulations targeted to the gastro-intestinal tract. Interestingly, few studies have examined adhesion within the oesophagus (Dobrozsi et al. 1999; Young et al. 1998; Potts et al. 2000 and Batchelor et al. 2003) and as yet, no antifungal oesophageal adhesive delivery devices have been reported. Viscous polymeric solutions are most commonly used as bioadhesive agents and polymers examined include; sodium alginate, pectin, xanthan gum, gelatin, carbomer, chitosan and hydroxypropylmethyl cellulose (HPMC). In order to enhance current therapeutic strategies used in the management of oesophageal diseases, this study will investigate bioadhesive liquid vehicles for the topical delivery of agents and thereby enhance drug concentration at the tissue surface, reducing the high systemic levels of drugs

currently required in therapy. Specifically this study will use miconazole nitrate as a model drug that may be used in the treatment of oesophageal candidiasis.

2.1.1 Miconazole nitrate salt

Miconazole nitrate is a well-known broad-spectrum antifungal agent of the imidazole group. As first line treatment of candidiasis, it has been extensively applied for the management of dermal (Minghetti et al. 1999), buccal (Bouckaert et al. 1993), and vaginal (Mandal 2000) candidiasis. The combination of two mechanisms is involved in the antifungal activity of miconazole: direct membrane damage of the fungal cells and ergosterol biosynthesis inhibition. The latter mechanism changes the integrity and fluidity of the membrane resulting in the lysis of fungal cell membranes. In this study, miconazole nitrate was selected as model drugs of antifungal agents for the treatment of oesophageal candidiasis.

The solubility of miconazole is extremely low in both water ($1.03\mu\text{g}/\text{mL}$) (Pedersen et al. 1999) as well as in oil ($10\mu\text{g}/\text{mL}$ in mineral oil) (Fujii et al. 2002). Moreover, miconazole is a weak base with a pKa of 6.7, high molecular weight and melting point. Therefore, the efficacy of miconazole is limited in many applications. Its poor water solubility and poor dissolution properties demonstrate a poor gastrointestinal absorption, which makes it a poor candidate for oral administration. Although a previously marketed miconazole intravenous solution reached the therapeutically level, the product was withdrawn from market due to the multiple toxic side effects caused by the surfactant (Peil et al. 2001). Miconazole is used primarily in topical formulations although high doses are normally required due to the poor skin-penetration in conventional dosage forms.

Various approaches have been used to improve the solubility and dissolution of miconazole to enhance the efficacy of oral and topical delivery. Dash & Cudworth (2001) used an acetic acid ester of monoglycerides as the base of suppository and demonstrated that the acetic environment increased the dissolution of miconazole which can be beneficial for the drug's therapeutic activity. Cyclodextrins has been known as another acceptable way to improve the aqueous solubility of

miconazole through noncovalent inclusion complexation (Barillaro et al. 2004; Barillaro et al. 2007; Lin et al. 2003; Hostetler et al. 1992). In consideration of a relatively large amount of excipients required for miconazole/cyclodextrin complexes, an aqueous solvent system was developed by Kovacs et al (2008) to enhance the solubility of miconazole. In this study, it demonstrated that the solubility of miconazole increased with decreased pH of the solution by various pH adjusters. The results also suggested that a considerable increase in solubility of miconazole can be achieved by using the combination of pH adjusters, co-solvents and surfactants. Moreover, the strategic approaches have also been carried out by supersaturation technology (Fujii et al. 2002), the preparation of nanoparticles (Kuntsche et al. 2004) and the use of bioadhesive carriers (Tenjarla et al. 1998) in the formulation development.

2.1.2 Bioadhesives

2.1.2.1 Chitosan

Chitosan is a semi-natural bioadhesive obtained by the hydrolysis of chitin, a natural bioadhesive polymer that can be found easily in crustaceans including the shells of crabs. During the past 20 years, a substantial amount of work has been published on this polymer and its potential use in various applications. Recently, chitosan has been considered for pharmaceutical formulation and drug delivery systems in which attention has been focused on its absorption-enhancing, controlled release and bioadhesive properties. Synthesized from a naturally occurring source, this polymer has been shown to be both biocompatible and biodegradable (Hirano et al. 1989). Moreover, chitosan has previously demonstrated antifungal efficacy thus it was selected as bioadhesive agents for its dual functionality (Ikinci et al. 2002).

Chitosan is a linear copolymer of β -(1-4) linked 2-acetamido-2-deoxy- β -D- glycopyranose (GlcNAc) and 2-amino-2-deoxy- β -D-glycopyranose which is the N-deacetylated derivative of chitin. Because a sharp nomenclature with respect to the degree of N-deacetylation has not been defined between chitin and chitosan

(Muzzarelli et al. 1994), chitosan is not easily defined in term of its exact chemical composition. It usually refers to a family of polymers that are characterized by the number of sugar units per polymer molecule, which defines the molecular weight, and the degree of deacetylation that affects the solubility of chitosan in aqueous solutions.

Owing to the presence of a number of amino groups, chitosan reacts with anionic systems leading to modification of the physicochemical characteristics of its combinations with these systems. For the gelled system of chitosan, hydrogels with the desired characteristics can be obtained by varying the ration of chitosan or using chitosan with different molecular weights to the anionic system used.

Both the number of GlcNAc units (degree of acetylation) and the molecular weight (MW) of chitosan have been shown to influence the physical and biological properties (Muzzarelli et al. 1990). Even though the degree of N-deacetylation affects the solubility of chitosan in aqueous solutions, chitosan is soluble in weak acidic solutions such as acetic acid, formic acid, and slightly soluble in weak alkaline solutions (Muzzarelli et al. 2003). Among chitosans of various ranges of molecular weight, better mucoadhesion was observed for higher molecular weight (approximately 1400 kDa) compared to lower-molecular weight chitosans (500 to 800 kDa) (Chae et al. 2005).

Chitosan has valuable properties as a biomaterial because it is considered to be biocompatible, biodegradable and non-toxic (Singla & Chawla 2001). The cationic character and the potential functional groups make it an attractive biopolymer for many biomedical and pharmaceutical applications. The unique properties of this highly basic polysaccharide include polyoxysalt formation, ability to form films, chelate metal ions and optical structural characteristics (Hench 1998).

From the biopharmaceutical viewpoint, chitosan has a novel characteristic of mucoadhesion and enhancement of paracellular drug transport via transient opening

of tight junction between epithelial cells (Hench 1998). The amino groups of chitosan may allow the establishment of different types of interactions with both non-ionic and ionic drugs, and also provide pH-sensitive systems, which swell in certain gastric conditions allowing a site-specific release. In mucosal drug delivery such as oral, ocular, nasal, and gastrointestinal drug delivery systems, chitosan has been considered one of the most safe and excellent candidate for drug adsorption enhancer.

2.1.2.2 Xanthan gum

Xanthan gum is a high molecular weight microbial desiccation-resistant polymer which is produced by a pure culture aerobic submerged fermentation of a carbohydrate with the microorganism *xanthomonas campestris*. It is naturally produced to stick the bacteria to the leaves of cabbage-like plants with a long chain polysaccharide composed of the sugars glucose, mannose, and glucuronic acid. As a hydrophilic anionic polymer, it has been widely used in oral and topical formulations, cosmetics and food (Talukdar et al. 1996; Andreopoulos & Tarantili 2001). In addition, xanthan gum has been widely used as bioadhesive carrier for antifungal agents (Ruissen et al. 1999).

Xanthan gum has a relatively reproducible specification as it is produced by fermentation. Each molecule consists of about 7000 pentamers and the gum is less polydisperse than most hydrocolloids. Its natural state has been proposed to be bimolecular antiparallel double helices forming a very stiff intramolecular (single molecule hairpin) double stranded helical conformation by the annealing of the less stiff 'natural' denatured elongated single stranded chains. The glucan backbone is protected by the side chains which lie alongside, making it relatively stable to acids, alkalis and enzymes. Use of different strains or fermentation conditions may give rise to differing degrees of acetylation and pyruvylation, which moderates the functionality (Becker et al. 1998).

The conversion between the ordered double helical conformation and the single more-flexible extended chain may take place over hours of annealing (equilibrating) at between 40°C - 80°C. The weakly bound network formed is highly

pseudoplastic, with viscosity reducing considerably a shear increase and returning in full immediately on release. High viscosity solutions (~1%) appear gel-like but still shear-thin (Zatz & Knapp 1984). The rationale for this strange behaviors is the hydrogen-bonded and entangled association between the side chains of the highly extended molecules, which resists dissociation. Shear thinning with greater strain is mainly due to the conformation of the side chains flattening against the backbone under shear, reducing the intermolecular interactions.

Xanthan gum is mainly considered to be non-gelling and used for the control of viscosity due to the weak associations demonstrated by weak-gel shear-thinning properties. It hydrates rapidly in cold water without lumping to give a reliable viscosity, encouraging its use as thickener, stabilizer, emulsifier and foaming agent. The consistent water holding ability may be used for the control of syneresis and to retard ice recrystallization (ice crystal growth) in freeze-thaw situations; xanthan gel strength being improved on freeze-thaw. The most important properties of Xanthan are the very high low-shear viscosity coupled and strongly shear-thinning character. The relatively low viscosity at high shear means that it is easy to mix, pour and swallow but its high viscosity at low shear gives good suspension and coating properties and lends stability to colloidal suspensions (Chaplin Martin, 2005; Junyaprasert & Manwiwattanakul 2008).

2.1.3 The objectives of this chapter

This study investigated the *in vitro* potential of bioadhesive liquids as vehicles to deliver antifungal drugs to the oesophageal mucosa. To understand the fundamental processes involved, the retention of the formulation, release of drug from within the formulation and efficacy of the drug at the site of action were examined. Chitosan and xanthan gum were used as bioadhesive liquid vehicles and polyethylene glycol or glycerol were used as drug-solubility enhancers; miconazole nitrate was used as a model drug.

2.2 Materials and Methods

2.2.1 Materials

Chitosan-M (Lot 17813LU) (Aldrich Chemical Company, Inc. USA) and gum xanthan (Lot 59H0718) (Sigma Chemical CO. St. Louis, MO) were used as bioadhesive vehicles targeted to the oesophagus. (\pm)-Miconazole nitrate salt (Lot 043K1249) (Sigma-Aldrich, Inc., St. Louis, MO) was incorporated into 2%w/v solutions of chitosan or xanthan with polyethylene glycol (Lot 38H0600) (Sigma Chemical CO. St. Louis, MO) or glycerol (Lot 61K0019) (Sigma Chemical CO. St. Louis, MO) as excipients to enhance drug solubility within the vehicle.

2.2.2 Determination of the absorbance peak of model drugs with UV spectrophotometer

As UV Unicam Helios β spectrophotometer was used to analyse the samples with model drug in the release study, thus a wavelength needed to be determined by analysis. In order to find the absorbance peak of the drug, the model drug was dissolved in methanol at concentration of 0.25mg/mL which was measured with the blank solution (pure methanol solution) zeroing the spectrophotometer. Miconazole nitrate salt had an obvious absorbance peak at 224nm so that the calibration was set up at this wavelength to quantify the release of the model drug from the formulations.

2.2.2.1 Porcine oesophageal tissue for ex vivo experiments

Porcine oesophagi from freshly slaughtered pigs were obtained from a local abattoir. The white inner epithelial tubes were dissected out by cutting the muscular layers and peeling off these outer muscular layers. The epithelium was then stored at -70°C . The frozen oesophageal tube was thawed at room temperature in saline solution before use.

2.2.3 Preparation of formulations

All formulations were prepared at pH4 to aid polymer solubility; acetate buffer was used for chitosan and xanthan gum formulations respectively. A Heidolph rotary mixer was used to prepare the polymer solutions at a concentration of 2%w/v. Miconazole nitrate was first dissolved in PEG or glycerol, then this was added into the polymer solutions to produce a formulation where the PEG or glycerol component was present at either 10 or 25%v/v. The final concentration of miconazole in the formulation was set at 25mg/mL. Each batch of hydrogel was prepared at a scale of 100mL.

2.2.4 Addition of technetium label to the formulation for the retention study

In order to quantify oesophageal retention the formulations were labeled *via* incorporation of Technetium tin colloid and quantitatively analyzed *via* radioactivity. For each experiment, 0.1mL (approx. 0.2 MBq activity) of the radionuclide Technetium 99m (Tc99m) was mixed with 1.5mL of each batch of hydrogel prepared in Section 2.2.3 under investigation by vortexing for 15 seconds. This mixing time was validated by separation of the formulation into 5 separate aliquots and the intersample variation in counts measured was less than 5% of the mean value.

The gamma counter used was a Packard Instruments Cobra Auto-Gamma machine. Studies were also performed to demonstrate that the label remained associated with the formulation over the time period of the investigation.

A strip of porcine oesophageal tissue was cut to suitable size and mounted onto the platform so that an enough tissue area (approximately 10mm×80mm) was exposed to the test adhesive polymer as seen in Figure 2.1. Then a dose of labelled polymer was added to the oesophageal surface with washing media running over the surface at 0.5mL/min for 30 minutes. The eluate was collected at designated time points for analysis. A special procedure was introduced as follows:

A preparation of about 10-20MBq of technetium tin colloid within 5mL was



Illustration removed for copyright restrictions

Figure 2.1: Retention model apparatus (Tang 2004)

supplied from City Hospital Birmingham. This material was kept within a lead pot for the duration of the experiment and was only opened for short periods for access to the material.

0.1mL of this solution was withdrawn from the vial using a syringe. This volume contained 0.2-0.4MBq of radioactivity. The radiolabel was added to a screw-top plastic vial containing 5mL solution of adhesion that had been prepared previously. The syringe used to dispense the radiolabel was discarded into a solution of 5% Decon. The radiolabel was blended with the adhesive solution using a vortex mixer for 30 seconds.

Approximately 1mL of the blended mix was drawn into a clean syringe; this syringe was then weighed using a weighing boat on a 4 decimal place balance. The volume was then dispensed onto the tissue surface and the syringe was reweighed to calculate the exact mass that had been added. When handling the syringe it was placed within a test-tube to avoid contamination of surfaces with radiolabel.

A further volume (1mL) of the original blend was drawn into a syringe and the syringe was weighed. This volume was then dispensed into a scintillation tube and the syringe was reweighed. This scintillation tube acted as a control to measure the counts per unit mass of the blended formulation.

Once the volume of material (1mL) had been dispensed onto the tissue surface the eluate was collected directly into scintillation tubes. Once material had been collected the scintillation tubes were capped to prevent spillage. All apparatus were placed on a tray that could collect radiochemical material should there be a spillage.

Retention was measured for all formulations tested in four duplicates and average values were reported. The presence of drug was examined as well as the presence of additional excipients including those that aided the solubility of the drug.

2.2.5 Viscosity of formulations

A Brookfield DV-I with spindle 4 was used to measure the viscosity of each batch hydrogels prepared in section 2.2.3 at 100mL. The shear rate was set at 5 sec^{-1} . The experiments were carried out in four duplicates and average values were reported.

2.2.6 Assessing the adhesive potential of the formulation

Bioadhesion was measured as the duration of liquid retention on porcine oesophageal mucosa during continuous washing, using an adaptation of the method described by Batchelor et al (2002), as seen in Figure 2.1. Porcine oesophagi were obtained fresh from a local abattoir on the day of slaughter. The oesophagi were gently rinsed with water to remove foodstuff and the outer muscular layer stripped away. The resulting oesophageal tubes consisting of epithelium and some external residual connective tissue were frozen at -70°C until required. Freezing the tissue prior to use has been discussed previously by Young et al (2002) and

is considered suitable for storing animal tissue with minimal damage. Furthermore, Smart et al (2003) reported that freezing porcine oesophageal tissue was necessary to inactivate the muscle tissue and provide the flat surface needed for the retention study. Freezing also reduces the detrimental effects of bacterial and enzymatic tissue degradation.

1mL of this labelled formulation was dispensed onto the tissue surface using a syringe, a second 1mL aliquot was retained for measurement to provide information on the counts per mL of each sample to allow for accurate analysis. During the experiment, the eluate flowing off the tissue section was collected directly into 2.5mL scintillation tubes at regular intervals up to 30 minutes. The radioactivity in each tube was measured in terms of counts per second (cps), and compared to the counts from the initial material to determine the percentage of the dose washed off at each time point; from this a retention profile for each formulation was generated in terms of percent retention on the oesophageal tissue over time.

2.2.7 Release of the drug

The release of drug from the viscous formulation (1mL) was assessed using Franz cells (Figure 2.2) with a receptor phase of continuously-stirred 30mL volumes of 50% methanol: 50% buffer at 37°C, the composition of the buffer was selected to ensure sink conditions. The Franz diffusion cells had a 2.52 cm² diffusion area and 30mL receptor volume, dialysis membrane (30000 Da cut off) was used as the membrane that separated the formulation from the receptor phase. Uniform mixing of the receptor medium was provided by magnetic stirring. Samples of 2mL were taken from the receptor medium at designated time intervals and replaced with the same volume of receptor medium. The concentration of each sample was measured *via* UV spectrometry according to a previously determined calibration curve. The experiments were carried out in four duplicates and average values were reported.

2.2.5 Efficiency of the setup

The setup was modeled after the design of the vertical diffusion cell (Tang 2004) and was used to study the effect of the concentration of the reactants on the rate of the reaction. The reactants were placed in two separate chambers and the reaction was allowed to proceed for a certain period of time before the products were analyzed.



Figure 2.2: Schematic representation of the vertical diffusion cell (Tang 2004)

2.2.8 Efficacy of the drug

This study was to establish whether a topical adhesive delivery device of the antifungal agents had a significant action against *Candida albicans*. The efficacy of drugs used within this study was assessed according to a microdilution method (National Committee for Clinical Laboratory Standards, 1997). Antifungal activities of the formulations were determined by the macro dilution method. A score assessment criteria was also set up.

2.2.8.1 Efficacy procedure of bioadhesive drug carriers

The oral *Candida* isolates (630G) were grown on an agar plate for 24 hr at 35°C in air. Then 5 colonies of *Candida* were selected and suspended in 0.85%w/v sterile saline. The suspension was vortexed for 15 seconds and the cell density adjusted so that it read the same as the standard cell suspension (1×10^6 cells/mL) at 530nm. When the cell suspension gave the same reading as the standard this meant that the suspension of *Candida* was approximately 1×10^6 cells/mL.

The formulation was diluted to 1:2; 1:4; 1:8; 1:16; 1:32 etc so that they went across all 8 wells respectively. 100 μ L of each diluted solution was added into a sterile 96 well plate.

1×10^6 cells/mL suspension was made a 1:100 dilution so that there were 1×10^4 cells/mL in sterile saline. Using RPMI 1640 broth medium, 1×10^4 cells/mL of suspension was made a 1:20 dilution so that there were 5×10^2 cells/ml.

A volume of 100 μ L of final diluted suspension was added to each well already containing 100 μ L of adhesive samples in the dilution series and a positive control well containing only *Candida* cells shown in Table 2.1. Concentration-response curves were determined for each formulation used within the study. Formulations that were optically opaque could not be measured in this way, therefore, plates were prepared as described for opaque formulations and a small volume from each well was swabbed onto an agar plate prior to incubation for 24 hours. The presence of

2.2 Materials and Methods

Table 2.1: The mixture samples in the plate for adhesive formulation efficacy study) available for a range of oesophageal diseases

Samples	Control	1	2	3	4	5
Formulation dilutions	N/A	1:2	1:4	1:8	1:16	1:32
Cells concentration (cells/mL)	5×10^2	5×10^2	5×10^2	5×10^2	5×10^2	5×10^2

Candida growth on the agar plates was then determined and the minimum concentration of formulation that inhibited growth of *Candida* was recorded. In each case controls of *Candida* alone (positive control) and formulation alone (negative control) were taken. The MIC (minimal inhibitory concentration) was defined as the minimum concentration of miconazole nitrate salt as a model drug to show full inhibition of *Candida* growth.

The plate was incubated at 35°C for 24 hours. After incubation, each well was scored according to a score assessment criteria by naked eyes to note whether there was any fungal growth and confirmed by a plate reader at 550nm.

A score assessment criteria was also set up as followed: 0=optically clear (no growth); 1=slight growth; 2= approximately one third of the well exhibits growth; 3= approximately half the area shows growth; 4=same as control (almost total surface covered with growth). The experiments were carried out in six duplicates and average scores were reported.

2.2.8.2 Determination of minimal inhibitory concentration of drug *via* growth on agar plates

The intensity of light at this wavelength is inversely proportional to the extent of fungal growth. Therefore, formulations used in this part were optically opaque could not be measured by reading at 550nm to calculate the percentage inhibition of light passage.

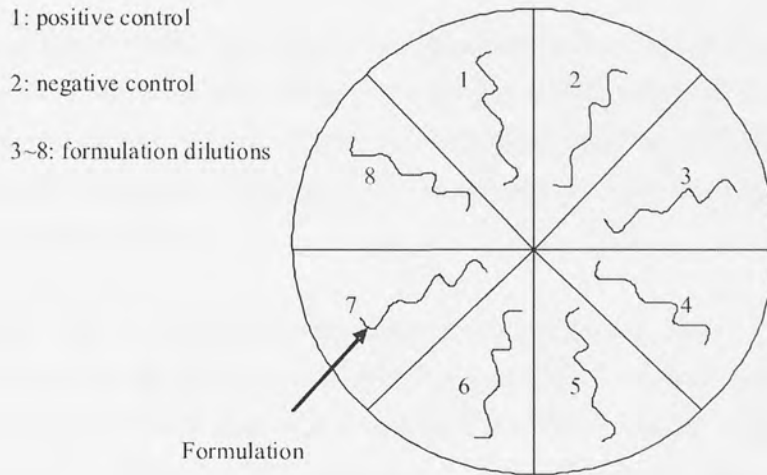

Figure 2.3: The distribution of samples on agar plate in MIC of formulation study

A suspension of *Candida* cells was added to each well of a sterile 96 well plate containing the samples of the dilution series of the formulation and a positive control containing *Candida* alone and a negative control containing formulation alone. The procedure was as same as described at 2.2.8.1

The Agar plates were prepared and divided into approximate 8 sectors from the centre as seen in Figure 2.3. Small volume from each well was swabbed onto an agar plate prior to incubation for 24 hours at 35°C.

The presence of *Candida* growth on the agar plates was then determined and the minimum concentration of formulation that inhibited growth of *Candida* was recorded. The same score assessment criteria was also set up to note whether there was any fungal growth. The experiments were carried out in six duplicates and average scores were reported.

2.2.9 Statistical significance test

Statistical significance test report the distinction between statistical significance and practical importance. It is possible for a difference of little practical importance to achieve a high degree of statistical significance. It is also possible for clinically important differences to be missed because an experiment lacks the power to detect them.

A *P* value was described as the observed significance level in experiments using statistical program (two-way ANOVA) in Excel. A null hypothesis was proposed at the 0.05 level that was know as the critical region. Data collected from experiments were said to be significant at the 0.05 level or less.

2.3 Results and Discussion

2.3.1 UV quantification of miconazole

The 0.05g miconazole nitrate salt was dissolved in 100mL methanol from which 1mL solution was removed and taken out to dilute to 0.5mg/mL. The solution was serially diluted twofold to 1:2, 1:4, 1:8, etc. The solutions were assayed at 224nm using a spectrophotometer. A calibration line was drawn from it. Figure 2.4 shows an example calibration line.

2.3.2 Viscosity effect of solubility enhancers in hydrogel liquids

The influence on viscosity of the type and the concentration of glycerol/PEG as solubility enhancers is shown in Figure 2.5. It is clear to see that xanthan solution had a significantly higher viscosity than chitosan in every sample ($p < 0.05$; two-way ANOVA). This phenomenon can be explained by the essential difference in the structures of chitosan and xanthan, although they are both polyelectrolyte polymers, their molecular structures are diverse. Chitosan is a linear copolymer with rod-like and rarely entangled chains. Compared with chitosan, xanthan has a relatively complicated structure with reproducible bimolecular antiparallel

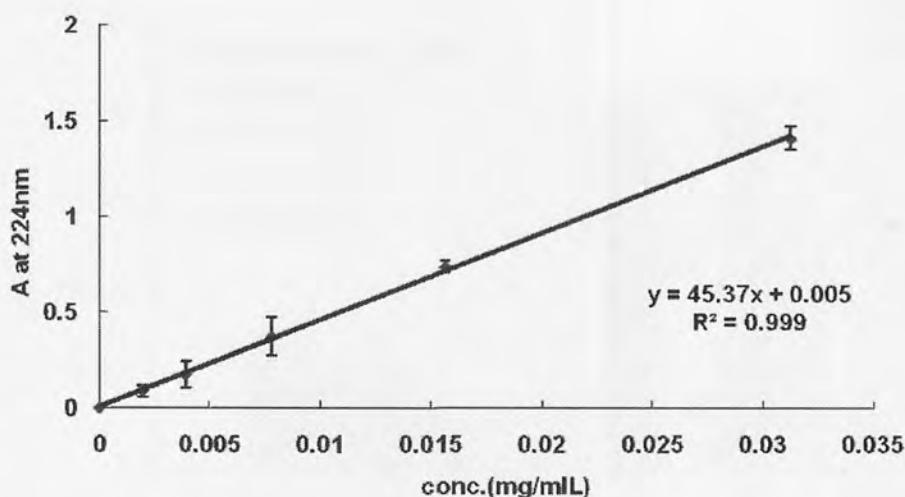

Figure 2.4: Calibration of miconazole nitrate in release experiment (data shows means \pm S.D., $n=4$)

double helices. Xanthan forms very stiff intramolecular double stranded helical therefore at low concentrations, the viscosity of a solution of xanthan is much higher than a chitosan solution at matched concentrations.

Figure 2.5 also showed that the additional enhancers increased the viscosities of xanthan formulations; on the contrary, it showed a negative effect in chitosan hydrogels. Chitosan at pH4 (acetate buffer) exists as the cationic polyelectrolyte due to the amino groups within the chitosan molecule dissociating, as the pKa of chitosan has been reported to be 6.3-7 (Singla & Chawla 2001). When the enhancer (glycerol or PEG) and chitosan were mutually dissolved in water, the presence of the glycerol/PEG may have disrupted the strong intramolecular chitosan network by obscuring some of the H-bonding sites to thus reduce the viscosity as observed in Figure 2.5. Xanthan is an anionic polymer, incorporation of additional excipients in this case did not reduce the viscosity but enhanced it; this can be explained by the fact that the xanthan network was undisturbed by the additional excipients yet their presence strengthened this structure by concentrating them within the meshwork to increase the overall viscosity. The results indicated

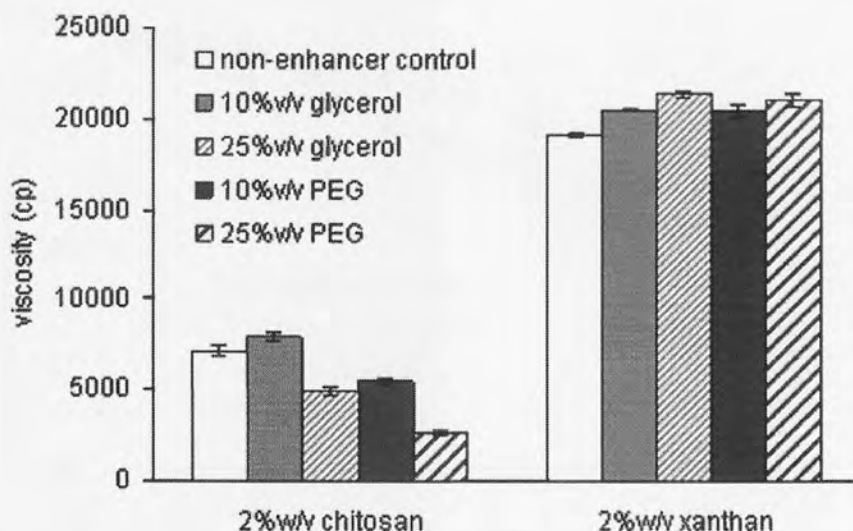

Figure 2.5: The viscosity of the formulations investigated within this study (data shows means \pm S.D., $n=4$), error bars show plus and minus standard deviations

that added enhancer (PEG or glycerol) and xanthan did not form associations but excluded one another; therefore, each polymer demonstrated an effective increase in concentration as its effective volume was decreased. As concentration is linked to viscosity, the observed viscosity was increased with the increase in concentration of excipients added.

2.3.3 Retention of the formulations

The bioadhesive liquids in this study were prepared containing miconazole at 25mg/mL. The xanthan gum formulations tested are shown in Figure 2.6. It can be noted that over 96% of the formulation was retained after 30 minutes indicating that this will be well retained within the oesophagus. Incorporation of the drugs/solubility enhancers improved the retention observed. The retention observed may be linked to the viscosity as the formulations that exhibited higher viscosity also demonstrated greater retention.

In comparison with the xanthan formulations, the retention profiles in all cases

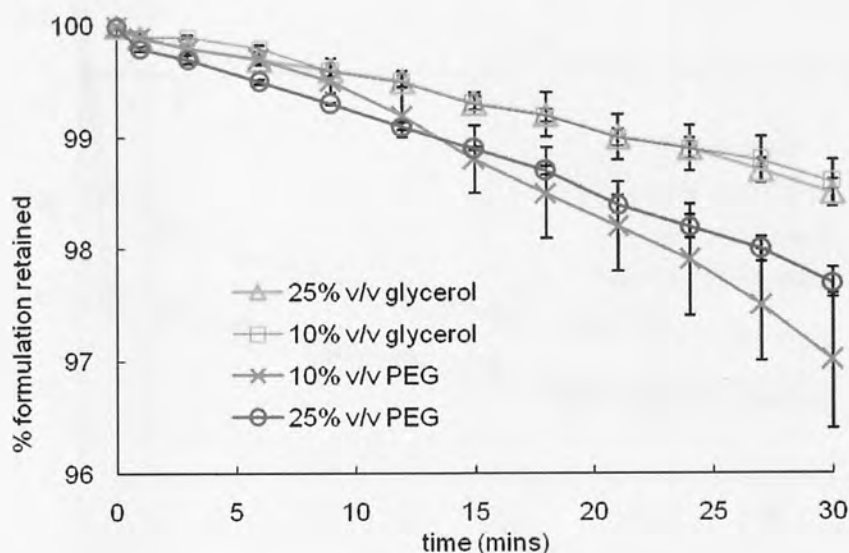

Figure 2.6: The retention profile of 2%w/v xanthan-based formulation in different vehicles; (data shows means \pm S.D., $n=4$)

with chitosan were biphasic, with rapid detachment of chitosan in first minutes of washing (Figure 2.7 Stage I) followed by a more controlled loss detachment of chitosan unable to establish a retentive interaction with the mucosa, Stage II in Figure 2.7. This biphasic profile was in agreement with Riley et al (2002) and Smart et al (2003) who studied retention of polymers on mucosa and observed a two-stage retention profile dependent on the ability of the polymer to interact with the mucosa. The first stage is attributed to initial loss of excess formulation applied and the second stage determined the ability of the formulation to adhere to the exposed mucosal surface. In each case, the overall retention of chitosan formulations was much lower than the xanthan formulations ($p < 0.05$).

Chitosan formulation with glycerol at 25%v/v showed significantly better retention compared to the other three samples ($p < 0.05$; two-way ANOVA at all time points examined). The formulation with 25%v/v glycerol retained 30% of the applied dose (1mL) over 30 minutes with miconazole; however, there was no significant difference between the retention of other formulations at the time points

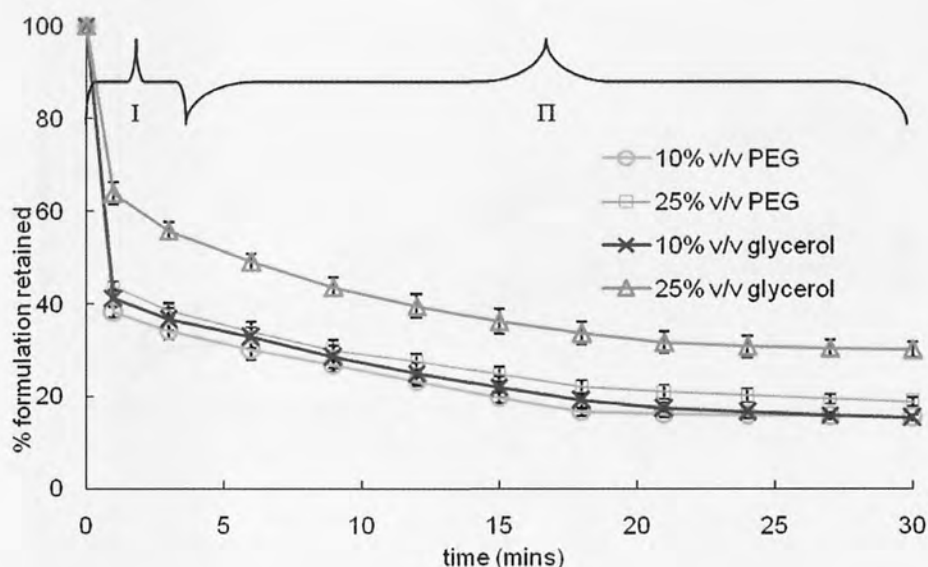

Figure 2.7: The retention profile of 2%w/v chitosan-based formulation in different vehicles; (data shows means \pm S.D., $n=4$)

investigated. Recently, Richardson et al (2004) and Richardson et al (2005) investigated the bioadhesive liquid dosage form using glycerol and PEG as vehicles to specifically adhere to the oesophageal mucosa and indicated that glycerol can rapidly hydrate and swell to form a viscous adherent layer on the mucosa that can resist elution. This could explain the increasing residence time of chitosan formulation when the glycerol concentration was increased from 10%v/v to 25%v/v.

2.3.4 Release of the drug

A drug formulation targeted to the oesophagus may gain intimate contact with the oesophageal mucosa for periods of up to 60 minutes (Batchelor et al. 2002). It is therefore important that the drug is released from within the formulation at concentrations that are sufficient for treatment of infection. A rapid release of drug from the formulation is required within this type of treatment strategy. Figure 2.8 compares the rate of release of miconazole from both chitosan and xanthan with polyethylene glycol (PEG) used as a solubility enhancer. Rapid re-

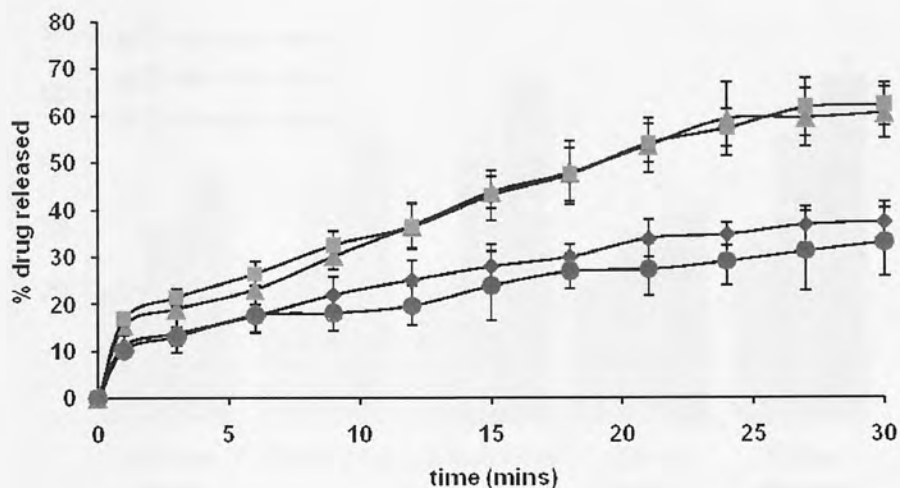

Figure 2.8: A comparison of the rate of miconazole release from solutions of chitosan and xanthan gum using PEG to enhance solubility; (▲) for 2%w/v Chitosan with 10%v/v PEG; (■) for 2%w/v chitosan with 25%v/v PEG; (●) for 2%w/v xanthan gum with 10%v/v PEG; (◆) for 2%w/v xanthan gum with 25%v/v PEG; (data shows means \pm S.D., $n=4$)

lease was demonstrated by both formulations with more than 50% of the loading dose of miconazole being released from the chitosan within 30 minutes. Chitosan demonstrated greater overall release compared to xanthan and this may be due to its lower viscosity. An increase in the concentration of PEG did not significantly increase the rate of drug release for either formulation thus a level of 10%w/w is sufficient for future formulations.

When miconazole was incorporated into either chitosan or xanthan at a concentration of 25mg/mL with PEG to aid solubility the release was significantly higher over 30 minutes with chitosan compared to xanthan. With the 2% chitosan gel formulation, $60 \pm 5\%$ and $62 \pm 4\%$ of miconazole was released after 30 minutes from the formulations containing 10% and 25% PEG, respectively. For 2% xanthan gels, the percent release was $33 \pm 7\%$ and $37 \pm 4\%$, respectively. An increased concentration of PEG, from 10 to 25%v/v, did not significantly alter

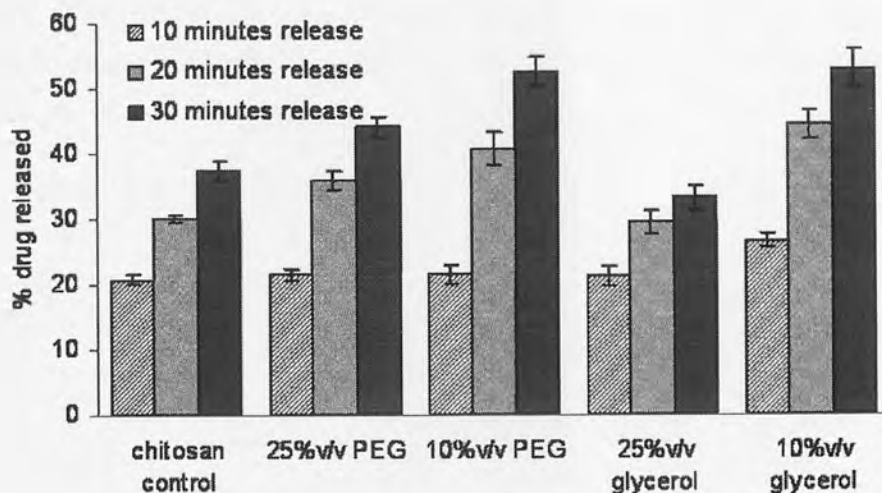

Figure 2.9: A comparison of miconazole release from solutions of chitosan containing PEG or glycerol at 10%v/v or 25% glycerol at time points of 10 minutes, 20 minutes and 30 minutes; (data shows means \pm S.D., $n=4$)

the release of the drug from either chitosan or xanthan. The effect of glycerol compared to PEG as a solubility enhancer was investigated; the results are shown in Figure 2.9.

The formulation with 10%v/v glycerol showed the greatest release with 53 \pm 2% of miconazole nitrate released after 30 minutes. Compared to the control formulation without glycerol, the diffusion rate of miconazole nitrate from the formulation with 10%v/v solubility enhancers (glycerol or PEG) was faster during the 30 minutes release. However, when the concentration of glycerol and PEG were increased to 25%v/v respectively, the drug diffusion rates from both formulations were decreased, with only 33 \pm 1% and 44 \pm 2% of drug were released in total over 30 minutes. It can be explained by functions of enhancers at different concentration in the formulation. When glycerol or PEG was added at lower concentration, it showed the main function that can improve the solubility of miconazole nitrate resulting in a faster diffusion rate over 30 minutes. Increased glycerol/PEG concentration reduced the amount of miconazole nitrate released

2.3 Results and Discussion

Table 2.2: The MIC (minimum inhibition concentration) of miconazole nitrate in chitosan hydrogel formulations and xanthan gum hydrogel formulations ($n=6$)

Formulation	MIC of xanthan gum formulation (mg/cm ³)	MIC of chitosan formulation (mg/cm ³)
control (without miconazole)	>25	10
10%v/v glycerol	6.25	6.25
25%v/v glycerol	12.5	6.25
10%v/v PEG	6.25	6.25
25%v/v PEG	12.5	6.25

from chitosan solution. This result may be related to the solubility coefficient of the drug between the donor and receptor mediums. If the drug is much more soluble in the donor, it will partition into this phase rather than the receptor phase where its solubility is reduced.

2.3.5 MIC study

The MIC values for the formulations tested were comparable for both chitosan and xanthan formulations (Table 2.2).

In two cases the MIC value was lower for chitosan compared to xanthan and this effect is likely to be due to the anti-fungal activity of chitosan itself as reported in other studies (Ikinici et al. 2002; Statroniewicz et al. 1994). Although the mechanism by which chitosan affects Candidal species is not clearly understood, Seo et al (1994) suggested that an ionic interaction between the cations of the amino groups of chitosan and anionic parts of bacterial cell wall such as phospholipids and carboxylic acids interact to induce the antimicrobial activity of chitosan. The MIC of 2%w/v chitosan hydrogel on *C. albicans* was 10mg/cm³. Senel et al (2000) has also studied the antifungal activity of chitosan and reported a MIC value of 10mg/cm³ for *C. albicans*.

2.4 Chapter Summary and Conclusions

In this study, the chitosan formulations showed approximately 20% to 40% retained after 30 minutes. If the retention is assumed to be 20% over 30 minutes this suggests that the initial drug loading should be $37.5\text{mg}/\text{cm}^3$ of miconazole to provide effective therapy. This also assumes that the drug is entirely released from the chitosan formulation. However, once this formulation is spread over the mucosal surface the diffusional distance from the formulation to the surface is minimised to also aid drug release.

Xanthan formulations were retained to a greater extent; assuming 90% retention then a loading concentration of $6.94\text{mg}/\text{cm}^3$ of miconazole is required (assuming the MIC of $6.25\text{mg}/\text{cm}^3$) or $13.9\text{mg}/\text{cm}^3$ assuming the MIC to be $12.5\text{mg}/\text{mL}$. However, as this formulation is retained in bulk the diffusional pathway from the formulation to the surface is increased meaning that less drug is in direct contact with the mucosal surface, therefore a higher loading concentration may be required.

2.4 Chapter Summary and Conclusions

2.4.1 Evaluation of bioadhesive liquid targeting the oesophagus

The investigation has developed and demonstrated the applicability of a bioadhesive drug delivery system for anti-fungal agents targeted to the oesophagus. Because of anti-fungal activity of chitosan, the efficacy of all formulations with chitosan was $6.25\text{mg}/\text{cm}^3$, whereas $12.5\text{mg}/\text{cm}^3$ was shown when xanthan solution was added enhancers (glycerol/PEG) at higher concentration at 25%v/v. Drug release studies agreed with the MIC results that increasing the concentration of the enhancers improved the solubility of the drug resulting in a reduced release of the drug. Both bioadhesive formulations with xanthan and chitosan showed no lag period in drug release, which is suitable for *in vivo* therapy. The bioadhesive formulations were proven to be well retained using an *in vitro* model. Xanthan was retained a far greater extent compared to chitosan. The level of drug loading required for a bioadhesive formulation targeting the oesophagus is feasible, with

2.4 Chapter Summary and Conclusions

the levels required with xanthan gum being lower than that currently used within oral miconazole gel products. Therefore, this preliminary study suggests that a bioadhesive formulation containing antifungal agents may be beneficial in the treatment of oesophageal *Candida*.

Chapter 3

Orally Retained Hydrophilic Films for Oesophageal Drug Delivery

3.1 General Background

3.1.1 Orally retained dosage forms

The most popular dosage form for oral drug delivery is the tablet. Tablets are formulated to be retained in the mouth for a short period of time, usually 5-15 minutes, and then pass into the stomach. However, there are some situations where a drug is required to be retained in the mouth for a longer period of time. For example, in the case of oesophageal drug delivery, the drug is required to be retained in the mouth for a longer period of time. The aim of this study was to develop a formulation for orally retained dosage forms. The study was conducted using a hydrophilic polymer, polyacrylamide, which is known for its ability to form a gel in the presence of water. The study was conducted using a range of concentrations of polyacrylamide and different drug concentrations. The results showed that the polyacrylamide-based films were able to retain the drug in the mouth for a longer period of time compared to a control formulation. The study also showed that the polyacrylamide-based films were able to form a gel in the presence of water. The study was conducted using a range of concentrations of polyacrylamide and different drug concentrations. The results showed that the polyacrylamide-based films were able to retain the drug in the mouth for a longer period of time compared to a control formulation. The study also showed that the polyacrylamide-based films were able to form a gel in the presence of water.

Chapter 3

Orally Retained Hydrophilic Films for Oesophageal Drug Delivery

3.1 General Background

3.1.1 Oral retained dosage forms

The most popular dosage form for oral administration is immediate release tablets. For controlled release applications, polymers are included as functional excipients and these can also demonstrate bioadhesive properties when in contact with a mucosal surface. To explore the potential of orally retained dosage forms for local drug delivery to the oesophagus, orally retained films and tablets were developed in the following two chapters as oral dissolving/eroding dosage forms. The key to an orally dissolving formulation targeting the oesophagus is to ensure that combined polymer and drug release will provide solubilised drug within viscosity-enhanced saliva that will better coat the oral cavity and oesophagus prolonging drug contact at the site of action. Wise et al (2004) demonstrated that the oesophageal transit time of a viscous formulation (60cps) was significantly longer than that of water. In the following two chapters, hydrophilic cellulose derivatives including methyl cellulose (MC), hydroxyethyl cellulose (HEC), hydroxypropyl-methyl cellulose (HPMC), were used respectively as polymeric matrices in orally

retained film and tablet formulations. With specific excipients, the rate of drug release and the bioadhesive behaviours of the hydrophilic matrixes can be tailored for the oesophageal targeting.

3.1.2 Cellulose and its derivatives

Cellulose is a straight chain polymer with a polydisperse linear homopolymer consisting of β -(1, 4)-D-glucopyranose unit. The polymer contains three reactive hydroxyl groups at the C-2, C-3, and C-6 atoms, which are general, accessible to the typical conversions of primary and secondary alcoholic OH group. The multiple hydroxyl groups on the glucose residues from one chain form hydrogen bonds with oxygen molecules on another chain, holding the chains firmly together side-by-side and forming microfibrils with high tensile strength. It is found in plants and mostly prepared from wood pulp and cotton. In addition, the hydrogen bonds and crystallinity of cellulose make it insoluble in the common organic solvent as well as in the water (Blaschek 1990).

The study of cellulose derivatives has attracted more and more attention due to its renewable, biodegradable, and biocompatible features. The hydrophilic matrix systems prepared with hydrophilic cellulose derivatives have been widely developed and the drug release mechanism from such systems have also been investigated in order to achieve modified drug release dosage forms for oral administration (Borgquist et al. 2006; Liew et al. 2006; Nerurkar et al. 2005). As most of cellulose ethers display good compression characteristics, they have been widely used with direct compression technique for tablet manufactures (Ikinci et al 2004). Such a solid dosage form can be formulated as a swellable or erodible matrix as required (Missaghi & Fassihi 2005). Moreover, hydrophilic cellulose derivatives have also been widely used in topical drug delivery because of their excellent adhesive characteristics (Gavini et al. 2002; Rao & Diwan 1998; Remunan-Lopez et al. 1998).

MC, HEC and HPMC are three wellknown hydrophilic cellulose ethers that have

been widely investigated in matrix systems development and for local drug delivery (Dhiman et al. 2008; Perioli et al. 2004; Kim et al. 2007). In these cellulose derivatives, HEC is the most hydrophilic followed by HPMC then MC (Rodriguez et al. 2000). Therefore, in this thesis, these three polymers were used for the oral dissolving dosage forms preparation to explore the relationship of matrix system hydrophilicity, polymer molecular weight, drug release mechanism and polymer dissolution rate, hence the composition of oral dissolving dosage forms can be optimized to achieve sustained polymer dissolution with drug particles dispersed readily for absorption through the oesophageal mucosa.

3.1.3 Drug release kinetics by mathematical modelling

Drug release from polymeric systems has been modelled in many different ways (see Kanjickal & Lopina 2004 for a full review).

In a hydrophilic matrix the following steps occur during dissolution;

- a high concentration gradient is formed when the vehicle is placed into the dissolution medium;
- upon imbibition of water the matrix swells and the shape alters;
- on contact with water the drug dissolves into this water and diffuses out of the polymer network;
- with increasing water concentration the diffusion coefficient of the drug decreases substantially;
- in the case of poorly water soluble drugs, the dissolved and dispersed drug coexist within the polymer network although only dissolved drug is available for diffusion;
- depending on the nature of the polymer the polymer itself can dissolve more or less rapidly than the drug, in cases of hydrophobic polymers this dissolution may be negligible (Siepmann & Peppas 2001).

3.1 General Background

The timescale of each of these stages determines the overall release profile of a drug from a hydrophilic matrix.

The Peppas equation (Equation 3.1) is a simple, yet comprehensive semi-empirical equation used to describe the release of drug from a polymeric matrix.

$$\frac{M_t}{M_\infty} = kt^n \quad (3.1)$$

Where M_t/M_∞ is the drug fraction released at time t , k is a kinetic constant, n is the diffusional coefficient related to the release mechanism. The diffusional coefficient, n , is dependant upon the geometry of the formulation and for a film, an n value of 0.5 indicates Fickian diffusion, $0.5 < n < 1$ indicates anomalous mechanism and $n=1$ indicates case II transport where the dominant mechanism for drug transport is due to polymer relaxation during gel swelling. Anomalous transport occurs due to a combination of Fickian diffusion and polymer relaxation (Colombo et al. 1995; Lowman & Peppas 2000). In anomalous transport the contribution of both Fickian diffusion and relaxation are considered to be additive as described in the model proposed by (Peppas & Sahlin 1989)(Equation 3.2) .

$$\frac{M_t}{M_\infty} = k_1 t^m + k_2 t^{2m} \quad (3.2)$$

Where k_1 and k_2 are the kinetic constants associated with diffusional and relaxational release respectively. To calculate the percentage of drug release due to Fickian mechanisms, the following equation (Equation 3.3) can be used where F is the fraction released due to Fickian mechanisms (Peppas & Sahlin 1989).

$$F = \frac{1}{1 + (k_2/k_1)t^m} \quad (3.3)$$

Previous studies have indicated that the release is determined by the type of polymer, its viscosity grade, hydration and polymer proportion in the formulation (Salsa et al. 2003; Williams et al. 2002). Ideal drug release from buccal dosage forms targeted to the oesophageal mucosa would demonstrate relaxation kinetics

where the drug flows over the oesophagus slowly within saliva that is viscous due to the presence of the dissolved polymer rather than controlled by diffusion pathway.

3.1.4 Microviscometry to quantify polymer dissolution

In hydrophilic polymer matrices, water ingress into the matrices initiates Fickian diffusion of the drug molecules due to the concentration gradient between the matrix and the surrounding dissolution medium; polymer relaxation rate varies according to the polymer concentration and molecular weight. It is expected that the fraction of release attributed to polymer relaxation increases over time as the polymers hydrate disentangle and dissolve into the surrounding dissolution medium.

Polymer dissolution is not often measured in controlled release delivery systems although methods available include differential refractometry, optical microscopy, ellipsometry, steady-state fluorescence, gravimetry, nuclear magnetic resonance and FT-IR imaging as described in a review by (Miller-Chou & Koenig 2003). A limitation with many of these techniques lies in the fact that modification of the polymer in some way is required for adequate analysis of the dissolution of the polymer; or that complex apparatus and analytical techniques are required for quantification of dissolution. Esnaashari et al. 2005 described the use of microviscometer to measure polymer dissolution from solid dispersions based on rolling/falling ball principle; this technique correlated very small changes in viscosity with polymer concentration.

In the following two chapters, the experimental data of polymer dissolution calculated from microviscometry alongside drug release data measured *via* HPLC, was compared with the mechanism of drug release from polymer matrices based on drug release data mathematically fitted to models, to provide an insight into the mechanism of release.

3.1.5 Orally retained films

Films are recently developed dosage forms for the administration of drug *via* retention within the oral cavity for absorption through the oral mucosal surface (e.g. buccal, sublingual delivery). As an oral delivery system targeted to the oesophagus, mucoadhesive films should be not only flexible, elastic and soft; but also strong enough to retained within the oral cavity for a sufficient time period. Moreover, an ideal film for oesophageal delivery would dissolve or disperse drug into swallowed saliva which can then target the oesophagus; concomitant release of the polymer to increase the viscosity of the saliva will further enhance retention within the oesophagus.

In this section, orally retained films containing 1mg miconazole per cm² were evaluated *in vitro* as drug delivery systems targeting both the oesophagus and oral cavity. Films were prepared from hydrogel liquids of methyl cellulose (MC), hydroxyethylcellulose (HEC) and hydroxypropylmethyl cellulose (HPMC) using glycerol as a plasticizer. Physical and mechanical properties of these films were measured, including tensile strength, elongation and elastic modulus as well as bioadhesion and swelling. The mechanism of drug release from polymer matrices of all films was investigated by quantification of drug dissolution using Peppas model. In addition, to establish whether a topical adhesive delivery device of the antifungal agents had a significant action against *Candida albicans*, MIC (minimum inhibition concentration) was investigated.

3.2 Materials and Methods

3.2.1 Materials

Miconazole nitrate (MN) was purchased from Sigma, UK. The polymers used to prepare the films were (Hydroxypropyl) methyl cellulose, HPMC, (50cps, 100cps, 4,000cps and 15,000cps); Hydroxyethyl-cellulose, HEC, (145cps) and Methyl cellulose, MC, (400cps); all polymers were purchased from Sigma, UK. Glycerol, from Sigma, UK, was used as a plasticizer. Phosphate buffered saline (PBS)

tablets at pH7.4 were purchased from Sigma and used as directed. Sodium dodecyl sulphate (SDS) from Sigma was used in PBS buffer at 1%w/v aid to the solubility of the drug. All other chemicals used were purchased from Sigma, UK and were used as received.

3.2.2 HPLC analysis of miconazole

HPLC detection of miconazole used a C-18 Spherisorb; Hyper Clone 5a DDS 150×4.60mm column with a mobile phase of ammonium hydrogen phosphate buffer: methanol 15:85 at a flow rate of 1mL/min with a 20µl sample injection and detection at 208nm.

3.2.3 Film preparation

The series of formulations tested allowed polymer composition, polymer concentration and plasticizer concentration to be investigated as variables that may affect the physical properties of the films formed as well as the release of drug from these films. The three groups of formulations were listed in Table 3.1, Table 3.2 and Table 3.3 respectively for the film investigation. The viscosity of each batch solution was measured in four duplicates and average values were reported.

The film formulations were prepared using MC, HPMC and HEC, in concentrations from 2%w/v to 8%w/v using PBS buffer (pH7.4); miconazole nitrate was incorporated in the polymeric solution at a concentration of 0.5%w/v after levigation with glycerol at 5%v/v or 10%v/v. The viscosity of these solutions was measured using a Brookfield viscometer DV-I with spindle 4 stirring at shear rate of 5 sec⁻¹. The well-mixed medicated liquids were left overnight at room temperature in a sealed container to ensure clear, bubble-free gels were formed (Nafee et al. 2003). 10mL of the liquid from each batch was then poured into a culture dish (diameter = 8cm) and allowed to dry at room temperature and atmospheric pressure for 2 days. 2 plates were prepared from each batch of composition. The weight, thickness and tensile properties of all dried films were measured. In all batches, the liquid used to prepare the films contained 50mg miconazole in total; resulting in a concentration of 1mg/cm² of miconazole in the film. The dried

3.2 Materials and Methods

Table 3.1: The properties and composition of solutions used to prepare films where glycerol composition was the main variable investigated (viscosity data shows means±S.D., $n=4$)

Formulation ID	polymer	Conc. (%w/w)	Glycerol %	Drug loading (%w/v)	Viscosity (cps)
MC4G5	MC	4	5	0.5	155.3±0.5
MC4G10	MC	4	10	0.5	182.1±0.3
HEC4G5	HEC	4	5	0.5	38.3±0.1
HEC4G10	HEC	4	10	0.5	46.3±0.1
HPMC4G5	HPMC	4	5	0.5	36.7±0.2
HPMC4G10	HPMC	4	10	0.5	47.7±0.1

films were conditioned at 25°C and 50±3% relative humidity in a desiccators containing magnesium nitrate saturated solution ($\text{Mg}(\text{NO}_3)_2 \cdot 6\text{HNO}_3$).

3.2.4 Physical and mechanical measurement

3.2.4.1 Film thickness and weight uniformity

The thickness of the polymer films was measured in at least 2 different sites using a micrometer to the nearest 0.001mm. Ten patches from each batch of 1cm by 1cm were cut by a sharp blade and a scale, and weighed on a 4 decimal place balance to measure the uniformity of weight of these patches.

3.2.4.2 Measurement of film swelling

An agar plate method was used to measure swelling as described previously (Nafee et al. 2003). Circles of 1cm diameter were cut from the film and the swelling properties of films were evaluated by determining the diameter of film swelling on the agar plate in an incubator maintained at 37°C. The increase in the diameter of the films was determined after 60 minutes and the percentage swelling, %S,

3.2 Materials and Methods

Table 3.2: The properties and composition of solutions used to prepare films where the concentration of each polymer was investigated as the variable (viscosity data shows means±S.D., $n=4$)

Formulation ID	polymer	Conc. (%w/w)	Glycerol %	Drug loading (%w/v)	Viscosity (cps)
MC2G5	MC	2	5	0.5	42.4±0.3
MC4G5	MC	4	5	0.5	155.3±0.5
HEC4G5	HEC	4	5	0.5	38.3±0.1
HEC6G5	HEC	6	5	0.5	142.9±0.3
HPMC6G5	HPMC	6	5	0.5	45±0.1
HPMC8G5	HPMC	8	5	0.5	130.5±0.2

was then calculated using the following Equation 3.4:

$$\%S = \frac{(D_t - D_0)}{D_0} \times 100\% \quad (3.4)$$

Where,

D_t is the diameter of the swollen film at time point t , D_0 is the original diameter of dry film at zero time point.

3.2.4.3 Measurement of mechanical properties

Mechanical properties of the films were evaluated using Hounsfield Test Equipment (Figure 3.1). Films were cut to 10mm width and 40mm length. These were held lengthways between two clamps positioned at a distance of 30mm apart. The inside surface of the clamps were covered with sponge to protect the film from being deformed by the grooves of the clamps. The tensile properties of the film were measured by pulling upwards by the top clamp at a rate of 4mm/s.

The following mechanical properties of each film was measured; tensile strength,

3.2 Materials and Methods

Table 3.3: The properties and composition of solutions used to prepare films where the molecular weight (100cps, 4,000cps and 15,000cps) of a single polymer was investigated

Formulation ID	MW level	Conc. (%w/w)	Glycerol %	Drug loading (%w/v)	Viscosity (cps±S.D.)
L-MW/ HPMC2G5	Low	2	5	0.5	27.8±0.2
L-MW/ HPMC2G10	Low	2	10	0.5	32.1±0.1
M-MW/ HPMC2G5	Medium	2	5	0.5	59.2±0.1
M-MW/ HPMC2G10	Medium	2	10	0.5	66.4±0.3
H-MW/ HPMC2G5	High	2	5	0.5	89.7±0.3
H-MW/ HPMC2G10	High	2	10	0.5	93.3±0.4

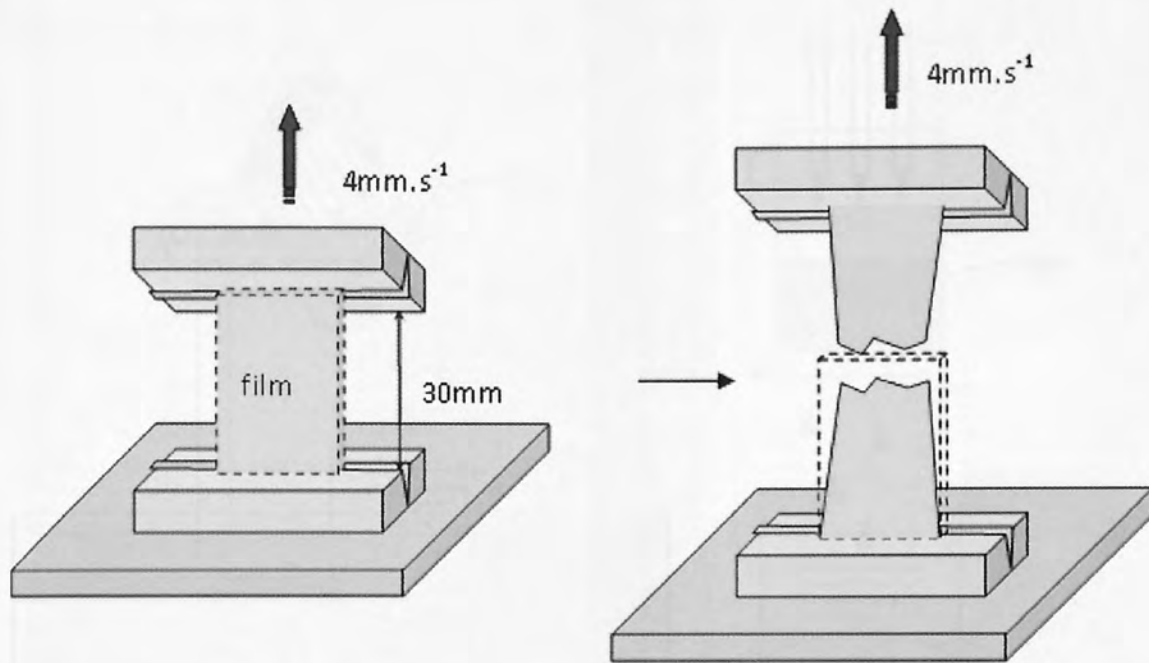

Figure 3.1: The tensile apparatus for mechanical properties study of buccal films elongation and elastic modulus. Tensile strength was measured directly using the QMAT file examination software; this was recorded as the maximum force and was measured immediately prior to the film breaking.

Elastic modulus was measured over the initial part of the tensile test and was the ratio of force to strain as described below (Equation 3.5), calculated directly using the QMAT file examination software:

$$\text{ElasticModulus}(mPa^{-2}) = \text{Tensile}(mPamm^{-2}) / \text{Elongation}(\%mm^{-2}) \quad (3.5)$$

The percentage elongation at the break was also measured.

3.2.4.4 Oral retention model

The comparison of adhesion of water soluble polymers to agar plates *in vitro* has been demonstrated in agreement with that of their nasal mucoadhesion *in vivo* (Nakamura et al. 1996). Therefore, the retention of films on sabouraud agar

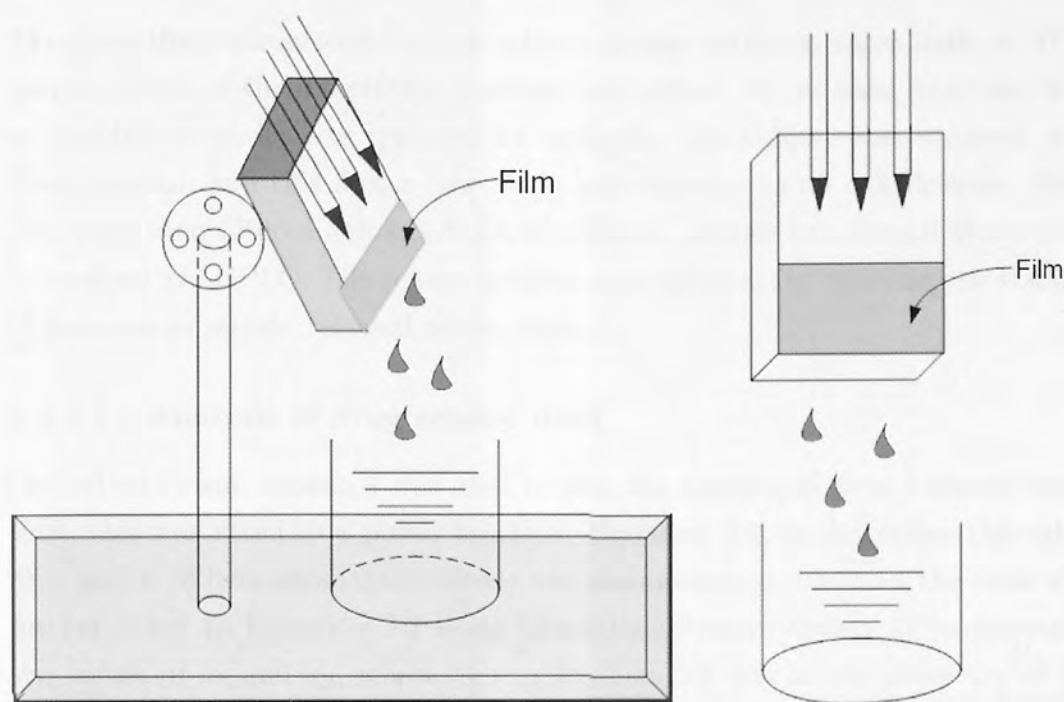

Figure 3.2: Apparatus used for measurement of residence time of formulations

plate surface was measured as a prediction of *in vitro* mucoadhesive properties of the film.

An *in vitro* retention model (Batchelor et al. 2002) inclined to an angle of 20° to the vertical was employed, with sabouraud agar substrate maintained at 37°C and high humidity ($>90\%\text{RH}$) (Figure 3.2). The dimensions 1cm^2 of the film was attached onto the agar substrate. The substrate was washed by PBS buffer (pH7.4) saline to mimic saliva flow at $0.5\text{mL}/\text{min}$ and the time taken prior to the film dislodging from the surface was recorded with the naked eye and reported as the residence time.

3.2.5 Drug release apparatus

Due to the low solubility of miconazole in PBS at pH7.4, $1\%w/v$ SDS was incorporated into this buffer and used as a dissolution medium to measure the rate of drug release from the films. 1cm^2 film was placed into a 25-mL conical flask.

The flask then was placed into an orbital shaker within a water bath at 37°C, 50rpm. 10mL of the dissolution medium was added. At set time intervals, 1mL of dissolution media was removed for analysis, this volume was replaced with fresh medium and this factor was taken into account in all calculations. Samples were then filtered through 0.45 μ m cellulose acetate membrane filters prior to analysis *via* HPLC. The release profiles were obtained by plotting the fraction of miconazole nitrate released versus time.

3.2.5.1 Analysis of drug release data

GraphPad Prism, version 4 was used to plot the fraction of drug released versus time, this was fitted to a power function, Equation 3.1, to determine the values of n and k . Where anomalous release was demonstrated $0.5 < n < 1$ the data were further fitted to Equation 3.2 using GraphPad Prism (version 4) to determine the values of k_1 and k_2 , where m was fixed as 0.5 due to the geometry of the film (Peppas & Sahlin 1989). For each fit the regression coefficient r^2 was also recorded indicating the goodness of fit.

3.2.6 Determination of polymer dissolution

Microviscometry technology was employed for polymer dissolution determination. As the viscosity of PBS buffer containing 1%w/v SDS at pH7.4 was not shown different with added miconazole, the presence of the dissolved polymer was the only factor that influenced the viscosity of the dissolution medium. Therefore, the dilutions of the standard polymer solution were prepared for the calibration curves. The polymer standard solutions were prepared in PBS saline at pH7.4 and the viscosities of the dilutions were determined by microviscometry. Calibrations for all polymers over the concentration were performed demonstrating the linearity of the relationship between concentration and viscosity over the range. An Anton Paar microviscometer that measures viscosity according to the rolling ball principle was used throughout.

3.2.6.1 Determination of polymer dissolution from films

The sample collection of polymer dissolution study was carried on following the same procedure as in the drug release section 3.2.5. The 1cm² film was placed into a 25-mL conical flask in 10mL dissolution medium. The flask was shaken at 50rpm within a 37°C water bath. 1mL sample was taken for analysis at set time intervals and the same volume of fresh medium was replaced this factor was taken into account in all calculations. Samples were then filtered through 0.45µm cellulose acetate membrane filters prior to analysis *via* microviscometer. The polymer dissolution profiles were obtained by plotting the concentration of HPMC dissolved versus time.

3.2.7 MIC study of orally retained films

As the orally retained films in this study were designed to deliver the drug to the oesophagus by dissolving the drug and polymers within swallowed saliva, the minimum inhibition concentration of each film formulation was studied using hydrocolloid form, which was the medicated liquid before film forming. This study was to establish whether a topical adhesive delivery device of the antifungal agents had a significant action against *Candida albicans*. Antifungal activities of the medicated liquid formulations listed in Table 3.1 and Table 3.2 were determined by the macro dilution method. A score assessment criteria was also set up.

3.2.7.1 Cell culture preparation

Cell culture preparation procedure was performed as described in section 2.2.8.

3.2.8 Statistical analysis

Statistical analysis was performed as described in section 2.2.9.

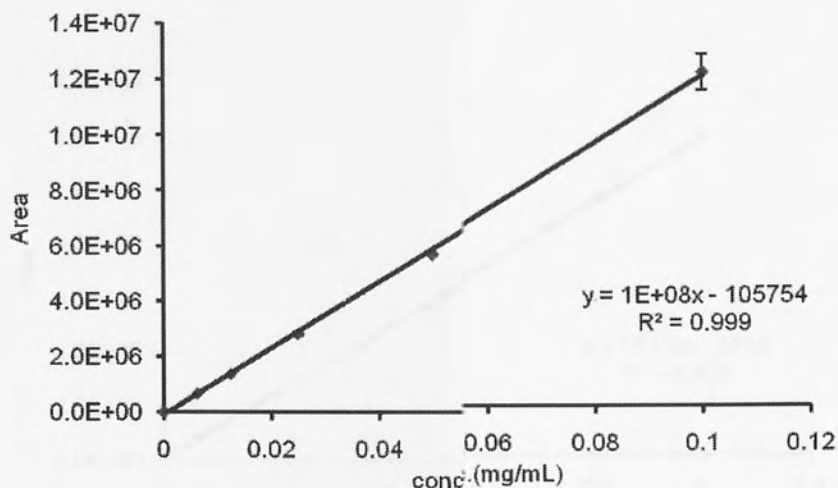

Figure 3.3: Calibration curve of MN using HPLC assay with the series of concentration at 0.00625, 0.0125, 0.025, 0.05, 0.1mg/mL (data shows means \pm S.D., $n=4$)

3.3 Results and Discussion

3.3.1 HPLC calibrations

As seen in Figure 3.3 and Figure 3.4, the calibrations according to the HPLC assay were performed ($r^2 > 0.999$) between 0.00625mg/mL to 1mg/mL; therefore, the concentrations of miconazole nitrate were determined *via* the calibration shown in Figure 3.5.

The limit of detection (LOD) and quantification (LOQ) for the drug was calculated according to Equation 3.6 and Equation 3.7

$$LOD = (3.3 \times STEY X) / S \quad (3.6)$$

$$LOQ = (10 \times STEY X) / S \quad (3.7)$$

Where,

3.3 Results and Discussion

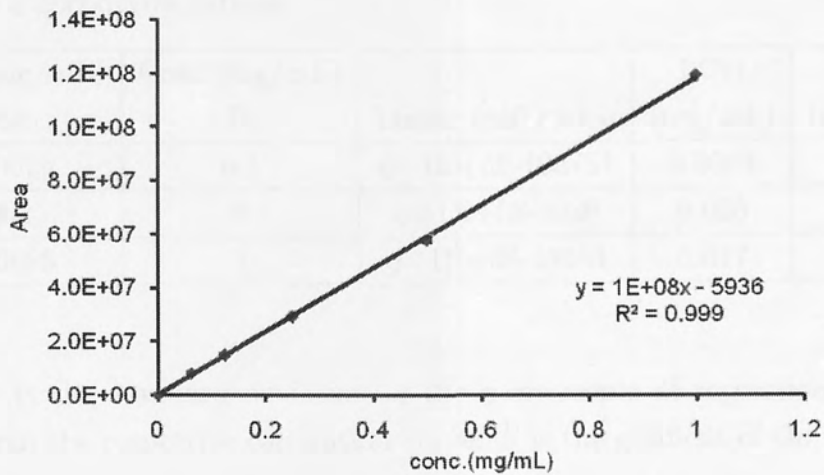

Figure 3.4: Calibration curve of MN using HPLC assay with the series of concentration at 0.0625, 0.125, 0.25, 0.5 and 1mg/mL (data shows means \pm S.D., $n=4$)

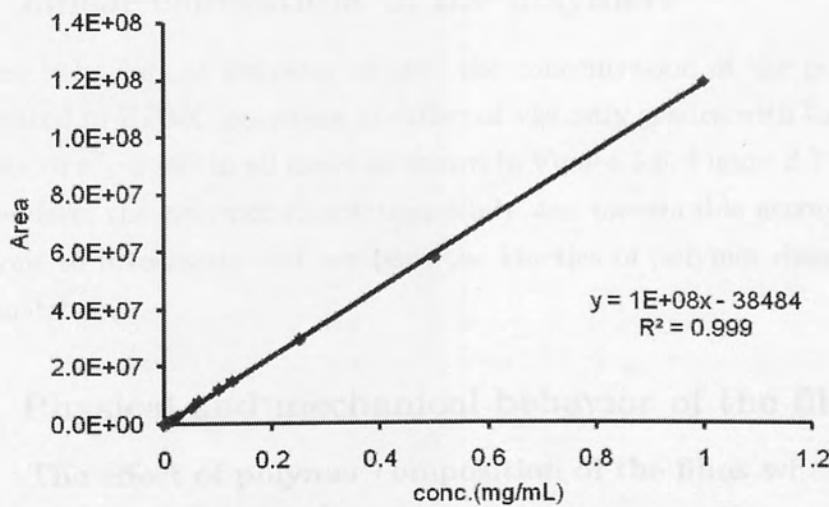

Figure 3.5: Calibration curve of MN using HPLC assay with the series of concentration from 0.00625 to 1mg/mL (data shows means \pm S.D., $n=4$)

3.3 Results and Discussion

Table 3.4: The limit of detection (LOD) and quantification (LOQ) for the calibrations of miconazole nitrate

Conc.(mg/mL) From	Conc.(mg/mL) To	Linear calibration	LOD (mg/mL)	LOQ (mg/mL)
0.00625	0.1	$y=1E+08-105754$	0.0003	0.010
0.0625	1	$y=1E+08-5936$	0.025	0.076
0.00625	1	$y=1E+08-38484$	0.017	0.051

STEYX is the standard deviation of the y -intercepts of regression lines, obtained from the respective calibration curve. S is the gradient of the calibration curve.

In all cases, the LOD and LOQ were summarized in Table 3.4. The LOD and LOQ values ranged from 0.0003mg/mL to 0.025mg/mL and from 0.010mg/mL to 0.076mg/mL, respectively.

3.3.2 Linear calibrations of the polymers

The linear behaviors of viscosity against the concentration of the polymers are demonstrated in HPMC polymers at different viscosity grades with linear regression values of $r^2 > 0.999$ in all cases as shown in Figure 3.6, Figure 3.7 and Figure 3.8. Therefore, the polymer dissolution study was measurable according to the calibrations to investigate and compare the kinetics of polymer dissolving from all film matrices.

3.3.3 Physical and mechanical behavior of the films

3.3.3.1 The effect of polymer composition of the films when polymer concentration was kept constant

Figure 3.9 and Figure 3.10 are schematic illustration of the film swelling results. It shows that all films swelled to some extent although the HEC and HPMC films swelled far more than the MC films. Moreover, the greater glycerol content in

3.3 Results and Discussion

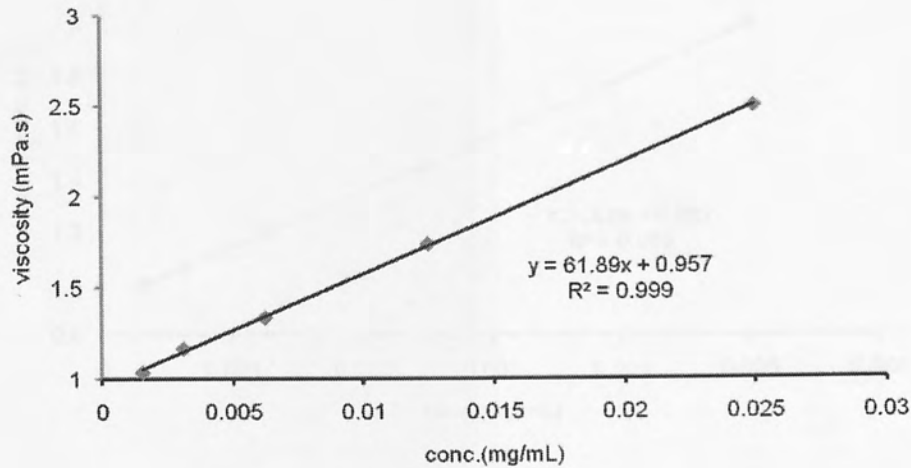

Figure 3.6: Calibration curve of HPMC (100cps) using microviscometry assay with the series of concentration from 0.0015 to 0.025mg/mL (data shows means \pm S.D., $n=4$)

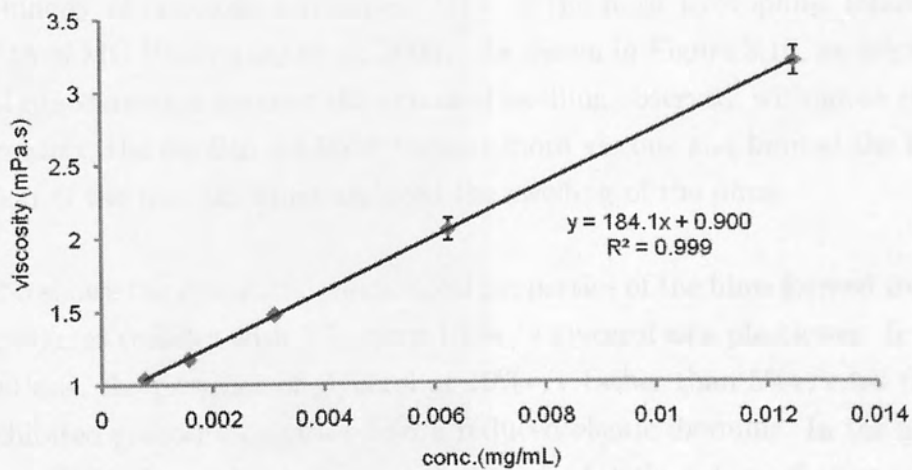

Figure 3.7: Calibration curve of HPMC (4,000cps) using microviscometry assay with the series of concentration from 0.0007 to 0.0125mg/mL (data shows means \pm S.D., $n=4$)

3.3 Results and Discussion

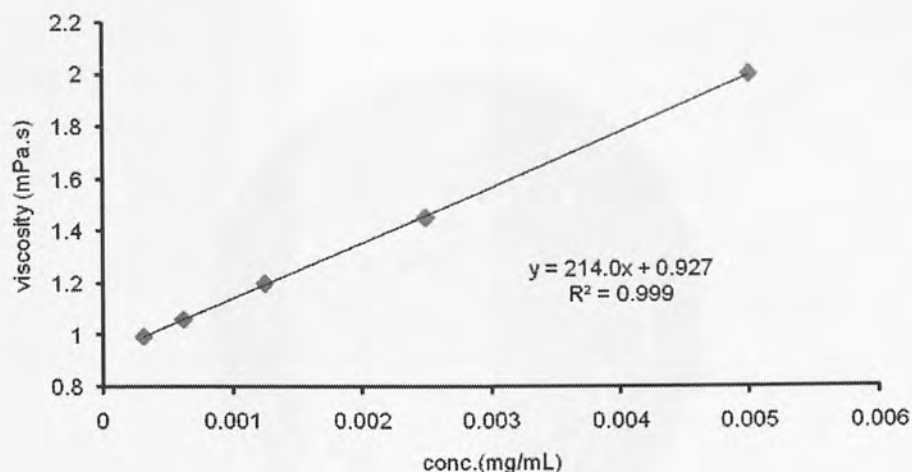

Figure 3.8: Calibration curve of HPMC (15,000cps) using microviscometry assay with the series of concentration from 0.0003 to 0.005mg/mL (data shows means \pm S.D., $n=4$)

the films resulted in more swelling. The percent swelling by diameter from three different polymeric matrices is listed in Table 3.5. These findings correlated to the hydrophilicity of cellulose derivatives, HEC is the most hydrophilic followed by HPMC then MC (Rodriguez et al. 2000). As shown in Figure 3.10, an increase in glycerol concentration reduced the extent of swelling observed, with more glycerol in the matrix; the swollen gel layer became more viscous and limited the further hydration of the matrix, which reduced the swelling of the films.

Table 3.5 shows the calculated mechanical properties of the films formed from different polymer vehicles with 5%v/v or 10%v/v glycerol as a plasticiser. In all six formulations, the presence of glycerol at 10%v/v rather than 5%v/v led to films that exhibited greater elongation and a reduced elastic modulus. In the absence of glycerol, film formation is limited due to the brittle nature of pure polymer films, such films cannot be manipulated to provide a flexible drug delivery device. Thus the function of the glycerol in the film is twofold, as a solubility aid for miconazole and a plasticiser to produce flexible strong films. Moreover, films that demonstrate elongation greater than 100% are very flexible, this property

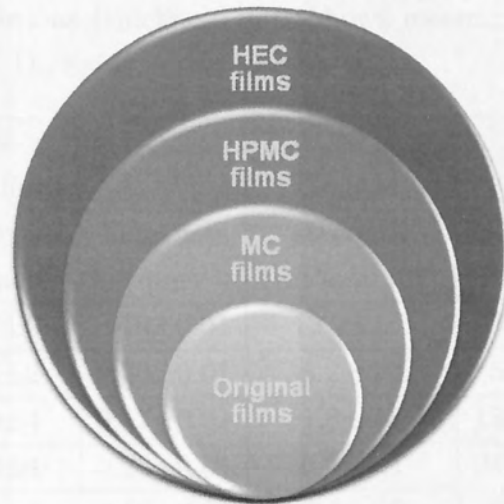

Figure 3.9: A schematic illustration of the swelling hydrated films

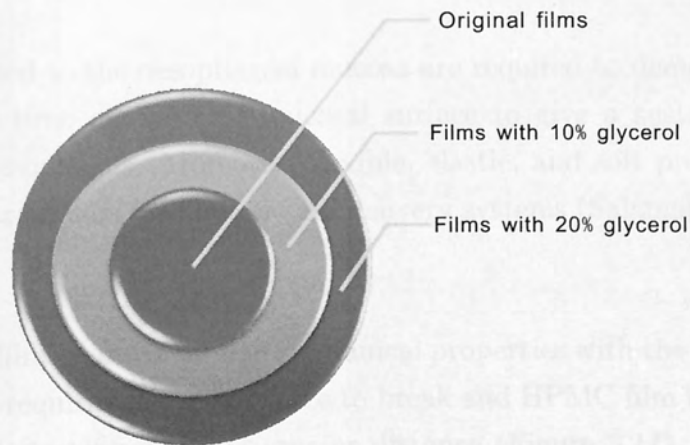

Figure 3.10: A schematic illustration of the effect of glycerol on the swelling behaviour of the hydrated films

3.3 Results and Discussion

Table 3.5: The physical and mechanical properties of the films prepared from 4 %w/v polymer solutions (thickness data shows means±S.D., $n=10$; thickness data shows means±S.D., $n=4$)

Formulation ID	% Swelling by diameter	Thickness (mm)	Tensile strength (mPa.mm ⁻²)	Elongation (%mm ⁻²)	%Elastic modulus (mPa)
MC4G5	12±2	0.18±0.01	12.2±1.6	38.4±3.0	31.8±1.7
MC4G10	10±2	0.30±0.01	5.2±0.5	53.8±3.8	9.6±0.2
HEC4G5	40±4	0.17±0.01	1.8±0.1	157.8±15.5	1.6±0.1
HEC4G10	30±4	0.22±0.01	0.6±0.1	244.4±20.2	0.2±0.02
HPMC4G5	25±3	0.10±0.01	6.4±1.9	62.8±8.5	10.1±1.8
HPMC4G10	15±3	0.11±0.01	8.7±1.7	92.9±14	9.72±3.1

was demonstrated by HEC films, although these films were relatively fragile as demonstrated by the low tensile force, although at such elongated lengths it was anticipated that the force required to snap these films was very low.

Ideal films targeted to the oesophageal mucosa are required to demonstrate prolonged residence time on the oral mucosal surface to give a sustained release of drug to the oesophagus. Moreover, flexible, elastic, and soft properties were also necessary parameters for films as oral delivery systems (Salamat-Miller et al. 2005).

HPMC and MC films showed similar mechanical properties with the MC films being stronger and requiring a greater force to break and HPMC film being slightly more elastic and stretching over a greater distance (Figure 3.11). The greater strength of the MC films is likely to be due to the strong polymeric chains in this matrix and the greater thickness of the MC films once prepared. The HEC film showed remarkably different properties being a very elastic film that stretches so much that the force required to eventually break the film is low, probably due

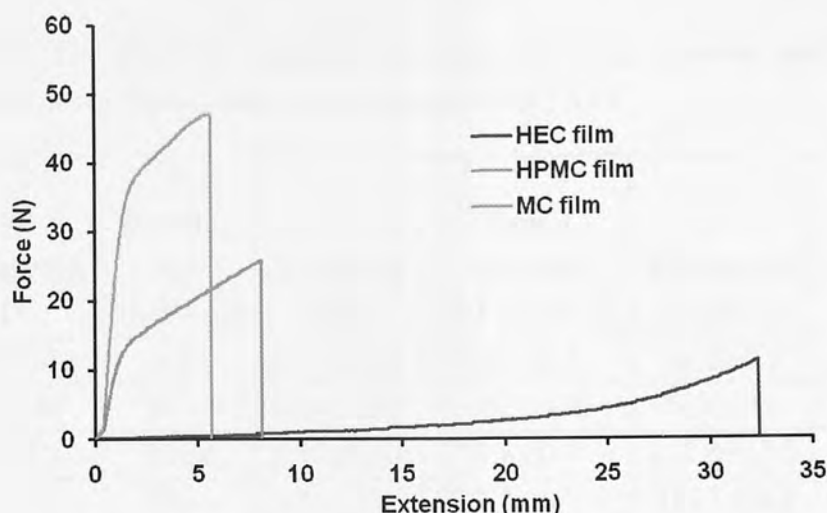

Figure 3.11: Typical traces of the mechanical properties of the films; the force required to stretch and break the films versus distance is shown

to the deformed film being far thinner after elongation of more than 150% of the original length. The results suggest that HEC films are the most flexible and can deform a great deal before breaking, both HPMC and MC films are strong and somewhat flexible.

3.3.3.2 The effect of polymer composition in the films

The effects of the polymer concentration on the physical and mechanical behavior of the films were shown in Table 3.6. In all formulations, the swelling behavior by diameter was increased when a higher percentage of polymer used. As these are hydrophilic polymers, increased polymer content gave the film greater ability to uptake the water into the matrix and retain this water. However, this increase in polymer content may also have made the films more solid like and the diffusion rate for water was expected to decrease although the overall swelling was increased. These results demonstrate that 60 minutes within the experimental time was sufficient for water ingress and swelling to occur. The films containing the higher concentration of polymer did not demonstrate increased thickness although the films were much stronger due to this increased content. In all films

3.3 Results and Discussion

Table 3.6: The effect of polymer concentration in the physical and mechanical properties of the films (data shows means \pm S.D., $n=4$)

Formulation ID	% Swelling by diameter	Thickness (mm)	Tensile strength (mPa.mm ⁻²)	Elongation (%mm ⁻²)	%Elastic modulus (mPa)
MC2G5	5 \pm 2	0.17 \pm 0.01	4.0 \pm 0.1	35.2 \pm 0.7	13.9 \pm 0.1
MC4G5	10 \pm 2	0.18 \pm 0.01	12.2 \pm 1.6	38.4 \pm 3.0	31.8 \pm 1.7
HEC4G5	40 \pm 4	0.17 \pm 0.01	1.8 \pm 0.1	157.8 \pm 15.5	1.6 \pm 0.1
HEC6G5	50 \pm 5	0.17 \pm 0.01	5.9 \pm 0.9	157.7 \pm 4.2	3.8 \pm 0.5
HPMC6G5	70 \pm 5	0.33 \pm 0.01	12.3 \pm 2.0	38.7 \pm 3.7	31.9 \pm 5.6
HPMC8G5	65 \pm 6	0.32 \pm 0.01	17.9 \pm 0.7	50.1 \pm 4.9	35.8 \pm 2.1

prepared in this group, the elongated lengths at the break time were not affected when increasing the polymer content, whereas more tensile force were required to break the films. Therefore, it indicated that the flexibility of the films was not affected when increasing the polymer content, whereas the films became stronger.

3.3.3.3 The effect of polymer molecular weight used to prepare the films

In the study of molecular weight effect, HPMC polymers with different molecular weight were used at the same concentration to prepare the films. Addition of glycerol at 10%v/v rather than 5%v/v also increased the thickness of films, although there was no relationship in viscosity of HPMC used and film thickness (Table 3.7).

The medium viscosity grade films were found to demonstrate the greatest mechanical strength as the tensile force was greatest to break these films. The other mechanical strength parameters did not demonstrate clear trends associated with the polymer properties used to form the films.

3.3 Results and Discussion

Table 3.7: The viscosity grade of HPMC used to prepare films and the physical and mechanical properties of the films (data shows means \pm S.D., $n=4$)

Formulation ID	Viscosity grade (cps)	Thickness (mm)	Tensile (mPa \cdot mm $^{-2}$)	Elongation (%mm $^{-2}$)	Elastic modulus (mPa)
L-MW/ HPMC2G5	100	0.09 \pm 0.01	6.9 \pm 0.5	79.5 \pm 4.8	8.7 \pm 0.5
L-MW/ HPMC2G10	100	0.16 \pm 0.02	1.7 \pm 0.6	52.0 \pm 6.8	3.1 \pm 0.7
M-MW/ HPMC2G5	4,000	0.10 \pm 0.01	9.6 \pm 1.1	80.3 \pm 7.7	12.0 \pm 0.7
M-MW/ HPMC2G10	4,000	0.11 \pm 0.01	9.5 \pm 1.1	117.2 \pm 6.1	8.1 \pm 0.5
H-MW/ HPMC2G5	15,000	0.10 \pm 0.01	4.5 \pm 0.6	54.1 \pm 11.5	8.4 \pm 1.5
H-MW/ HPMC2G10	15,000	0.15 \pm 0.04	8.2 \pm 0.5	131.5 \pm 25.4	6.4 \pm 1.1

3.3 Results and Discussion

Table 3.8: Diffusional coefficient, n and release constant k (Equation 3.1); diffusional (k_1) and relaxational (k_2) kinetic constants (Equation 3.2) and the correlation coefficient (r^2) for drug release from each different polymeric film matrices with different concentration of glycerol (mean data fitted from $n=4$)

Formulation ID	n	k ($t^{-n} \times 10^{-3}$)	r^2	k_1 ($t^{-0.5} \times 10^{-3}$)	k_2 ($t^{-1} \times 10^{-3}$)	r^2
MC4G5	0.86	9.99	0.99	8.47	4.68	0.99
MC4G10	0.68	7.54	0.91	8.05	1.02	0.92
HEC4G5	0.45	77.20	0.98	74.20	0.00	0.97
HEC4G10	0.54	72.39	0.99	66.69	1.34	0.99
HPMC4G5	0.24	410.30	0.92	201.70	0.00	~ 1.0
HPMC4G10	0.64	113.30	0.98	116.30	12.07	0.98

3.3.4 *In vitro* drug release mechanism from orally retained films

3.3.4.1 The effects of glycerol in different matrices with different hydrophilicity behaviors

In this section, three polymeric films formed from a range of hydrophilic polymers were prepared with glycerol content at both 5 and 10%w/w. This study provides information on both the nature of the polymer vehicle and also the effect of two alternative concentrations of glycerol on drug release. The mean data of 4 repeats of each film was fitted to Equations 3.1 and 3.2 and the results of this fitting process are shown in Table 3.8.

The release mechanism for each of the films was initially characterised in terms of the Peppas power law (Equation 3.1), with the kinetic constant, k providing information on the speed of drug release with a high value indicating rapid drug release. For all three polymeric films, the inclusion of glycerol at a higher percentage, 10%v/v versus 5%v/v reduced the release rate for the drug from all films, likely to be as a result of the increased viscosity of matrix through which the

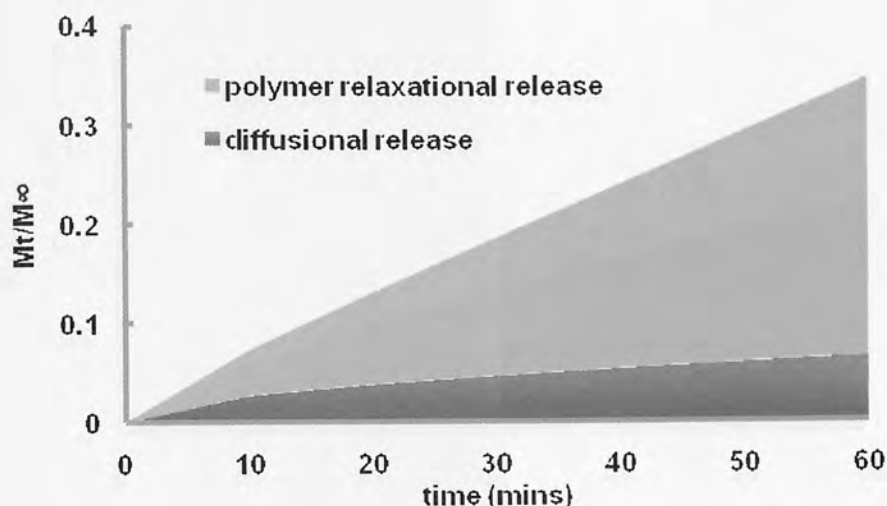

Figure 3.12: The contributions of Fickian diffusion and polymeric relaxation in the drug release from MC film containing 5%v/v glycerol (data shows means \pm S.D., $n=4$)

drug was more difficult to diffuse from the matrix. A diffusion coefficient value, n , between 0.5 and 1 was indicative of anomalous release whereas a value of 0.5 indicated Fickian diffusion was the predominant mechanism of release. Most films demonstrated anomalous release mechanisms although the HEC and HPMC films containing low concentration of glycerol at 5%v/v, demonstrated a tendency to Fickian release.

Further analysis using the polynomial equation suggested by Peppas and Sahlin (1989) was performed to determine the approximate amount of drug release by Fickian diffusion and by polymer relaxation as shown in the first and the second term in Equation 3.2 respectively. Figure 3.12 and Figure 3.13 demonstrate the relative contributions of the Fickian diffusion and polymer relaxation on drug release from MC films over 60 minutes time. An increase of the glycerol content from 5%v/v to 10%v/v limited the dissolution rate of the polymer with reduced polymeric relaxation contribution in comparison with the Fickian diffusion release as seen Figure 3.13. However, the MC films show a strong tendency towards re-

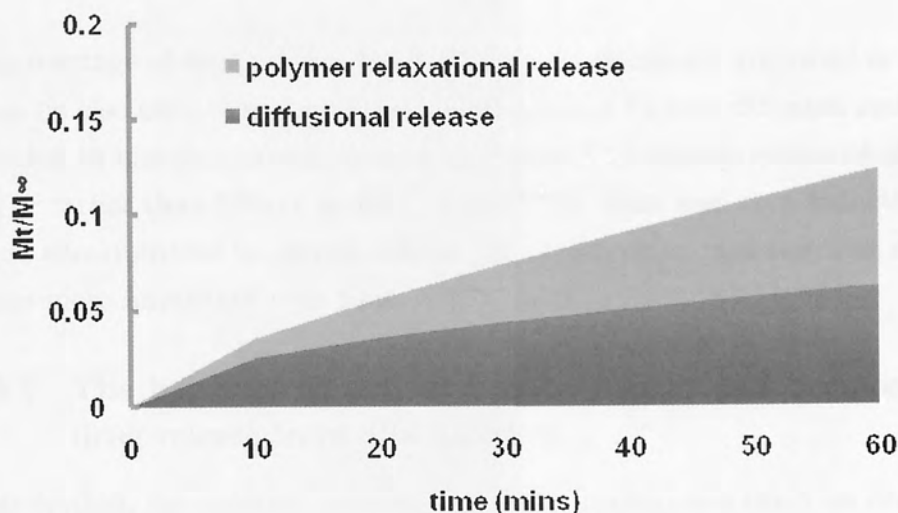

Figure 3.13: The contributions of Fickian diffusion and polymeric relaxation in the drug release from MC film containing 10%v/v glycerol (data shows means \pm S.D., $n=4$)

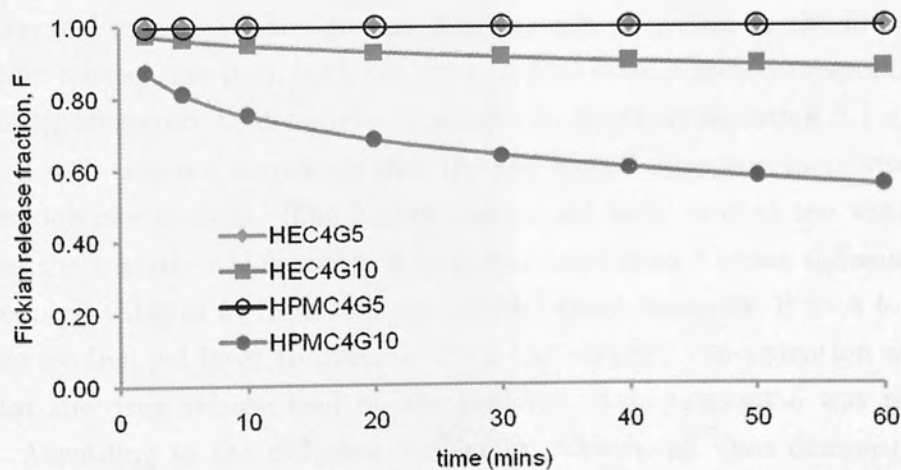

Figure 3.14: Fickian release fraction as a function of released miconazole from HEC and HPMC films with 5%v/v and 10%v/v glycerol respectively (data shows means \pm S.D., $n=4$)

laxational release over time.

The percentage of drug release due to Fickian mechanisms, described in Equation 3.3 can be also used to evaluate the contribution of Fickian diffusion and polymer relaxation in matrix system. As seen in Figure 3.14, incorporation of glycerol at 10%v/v rather than 5%v/v in HEC and HPMC films lead to a reduction in the Fickian contributions to overall release, thus indicating that polymer relaxation became more important over time.

3.3.4.2 The influence of polymer concentration and composition on drug release from film matrices

In this section, the polymer composition and concentration effect on drug release mechanisms was studied and the formulation components were listed as Table 3.2 in 3.2.3. Table 3.9 showed the parameters of the drug release kinetics from the mean drug release data fitted to Equations 3.1 and 3.2. The drug release mechanisms were described by the Peppas power law (n) and visualized according to the Fickian diffusional (k_1) and polymer chain relaxation (k_2) constants.

As seen in Figure 3.15, the greater polymer concentration in the films reduced the drug release rate from both MC and HPMC films, which corresponded to the reduced parameters of drug release speed (k) fitted to Equation 3.1 and 3.2 in Table 3.9. It was not surprising that the swollen gel layer was more viscous with higher polymer content. The highly viscous gel layer limited the water uptake rate of the matrix, which resulted in a decreased drug Fickian diffusion as seen the reduced value of k_1 from MC and HPMC films; moreover, it took longer time for the swollen gel layer to dissolve when the polymer concentration was higher so that the drug release lead by the polymer chain relaxation was reduced as well. According to the diffusion coefficient value n , all films demonstrated the trend towards more anomalous release mechanisms as increased n values were observed as the polymer concentration increased. On the other side, as seen in Figure 3.16, the Fickian release fraction parameters were reduced from all films as the polymer content increased, which indicated that the polymer loading present

3.3 Results and Discussion

Table 3.9: Diffusional coefficient, n and release constant k (Equation 3.1); diffusional (k_1) and relaxational (k_2) kinetic constants (Equation 3.2) and the correlation coefficient (r^2) for drug release from each film with different polymer content (mean data fitted from $n=4$)

Formulation ID	n	k ($t^{-n} \times 10^{-3}$)	r^2	k_1 ($t^{-0.5} \times 10^{-3}$)	k_2 ($t^{-1} \times 10^{-3}$)	r^2
MC2G5	0.71	33.36	0.99	37.01	5.35	0.99
MC4G5	0.86	9.99	0.99	8.47	4.68	0.99
HEC4G5	0.45	77.20	0.98	64.2	0.00	0.97
HEC6G5	0.65	4.38	0.97	48.52	4.43	0.97
HPMC6G5	0.86	9.27	0.96	10.08	3.89	0.96
HPMC8G5	0.93	4.75	0.98	2.82	3.18	0.98

positively increased the contribution of polymer relaxation in drug release in hydrophilic the matrix systems.

As seen from Figure 3.17, the drug release mechanism from HEC4G5 film was almost fully Fickian diffusion controlled. Due to the very hydrophilic behavior of HEC, the polymer dissolved very quickly prior to drug release/dissolution from the matrix, thus the mechanism was Fickian diffusion as the rate of drug particles dissolution was only dependant on the solid-liquid concentration gradient. On the other hand, with greater HEC content in the film, the matrix was more swellable rather than soluble as the water uptake was improved with a loose network formed. Therefore, the contribution from the polymer relaxation became more important over the time course of drug release as seen in Figure 3.18.

3.3.4.3 The drug release kinetics study by using the polymeric systems (HPMC) at different molecular weight grade

According to the previous study, HPMC matrix showed good hydrophilic behaviour with a loose polymeric network for sustained drug release *in vitro*, which is desirable characteristic of drug release for local drug delivery to the oesoph-

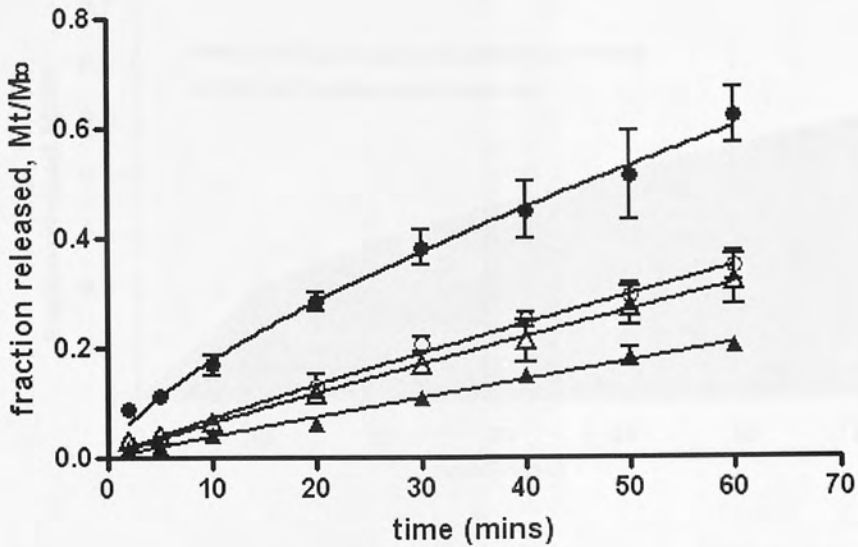

Figure 3.15: Fraction of miconazole released from MC and HPMC films with different polymer contents: MC2G5 (●); MC4G5 (○); HPMC6G5 (▲); HPMC8G5 (△) (data shows means \pm S.D., $n=4$)

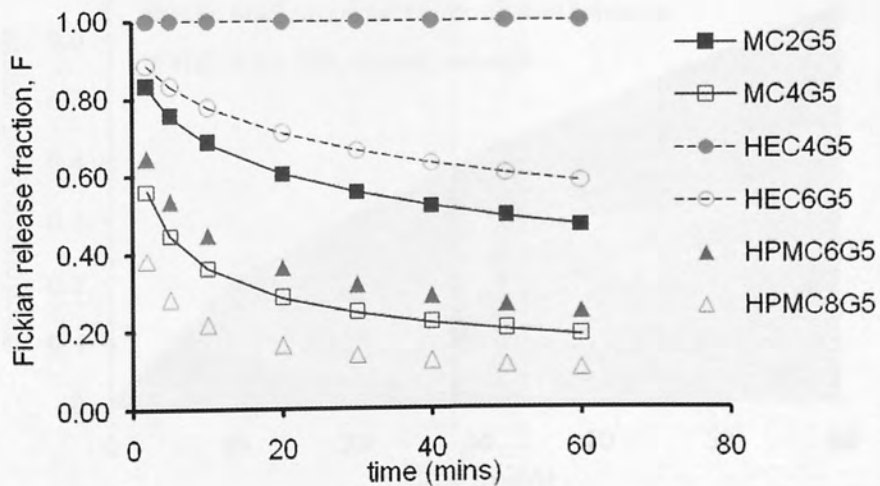

Figure 3.16: Fickian release fraction as a function of released miconazole from MC, HEC and HPMC films with different polymer content respectively (data shows means \pm S.D., $n=4$)

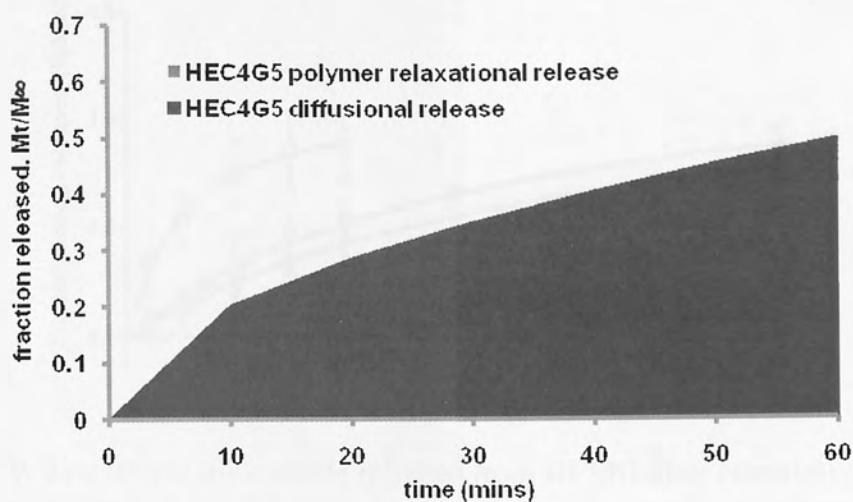

Figure 3.17: The contributions of Fickian diffusion and polymeric relaxation in the drug release from HEC film containing 5%v/v glycerol and 4%w/v HEC ($n=4$). (Compared to the most contribution from diffusional release mechanisms, the drug release according to the polymer relaxation was very little.)

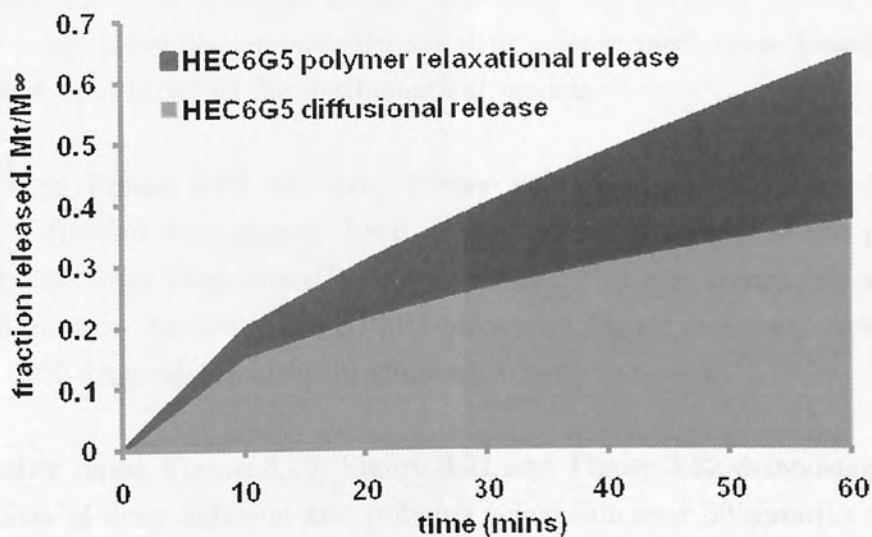

Figure 3.18: The contributions of Fickian diffusion and polymeric relaxation in the drug release from HEC film containing 5%v/v glycerol and 6%w/v HEC ($n=4$)

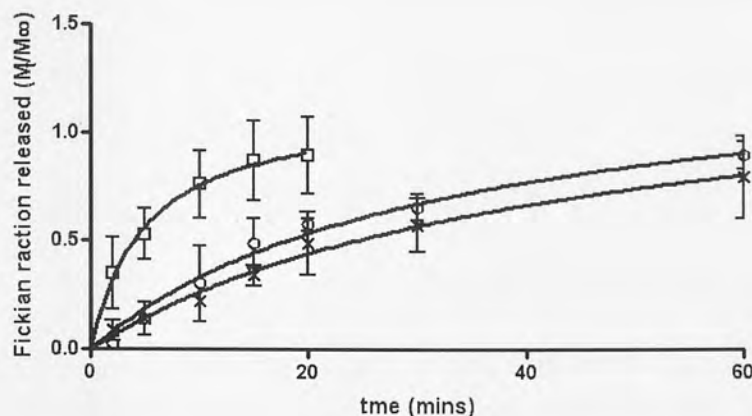

Figure 3.19: Fraction of miconazole released from HPMC films containing 5% v/v glycerol using different molecular weight (MW) grade: 100cps(□); 4,000cps(○) and 15,000cps(×). Lines represent fitted data according to Equation 3.1 (data shows means \pm S.D., $n=4$)

agus. In terms of optimization of the vehicles, the further drug release study was focussed on HPMC films prepared with different molecular weight levels at 100cps, 4,000cps and 15,000cps grade. Moreover, the polymer dissolution rate was also investigated to demonstrate the drug release mechanism based on the drug release data fitted to the mathematical models.

As seen from Figure 3.19, the drug release rates from HPMC films containing 5% v/v glycerol were slowed down as the molecular weight of the polymer increased; the drug from lowest viscosity HPMC film was completely released within 20 minutes, however, the HPMC films with higher molecular weight still provided 50% drug release after 30 minutes.

On the other hand, Figure 3.20, Figure 3.21 and Figure 3.22 demonstrated the distributions of drug diffusion and polymer relaxation over 30 minutes drug release from three viscosity grades HPMC films. In all cases, the drug release controlled by polymer relaxation raised over the time, although the drug diffusion took the main role during the whole release processes. With greater viscosity grade HPMC, the drug release controlled by Fickian diffusion was limited with

3.3 Results and Discussion

Table 3.10: Diffusional coefficient, n and release constant k (Equation 3.1); diffusional (k_1) and relaxational (k_2) kinetic constants (Equation 3.2) and the correlation coefficient (r^2) for drug release of the HPMC films using different molecular weight (mean data fitted from $n=4$)

Formulation ID	n	k ($t^{-n} \times 10^{-3}$)	r^2	k_1 ($t^{-0.5} \times 10^{-3}$)	k_2 ($t^{-1} \times 10^{-3}$)	r^2
L-MW/ HPMC2G5	0.34	285.00	0.97	220.80	0.0001	0.99
L-MW/ HPMC2G10	0.52	203.30	0.94	211.30	0.96	0.94
M-MW/ HPMC2G5	0.59	84.70	0.94	97.19	3.10	0.93
M-MW/ HPMC2G10	0.48	90.29	0.96	86.26	0.0001	0.95
H-MW/ HPMC2G5	0.62	68.05	0.97	73.75	4.26	0.96
H-MW/ HPMC2G10	0.67	26.47	0.99	30.09	3.03	0.98

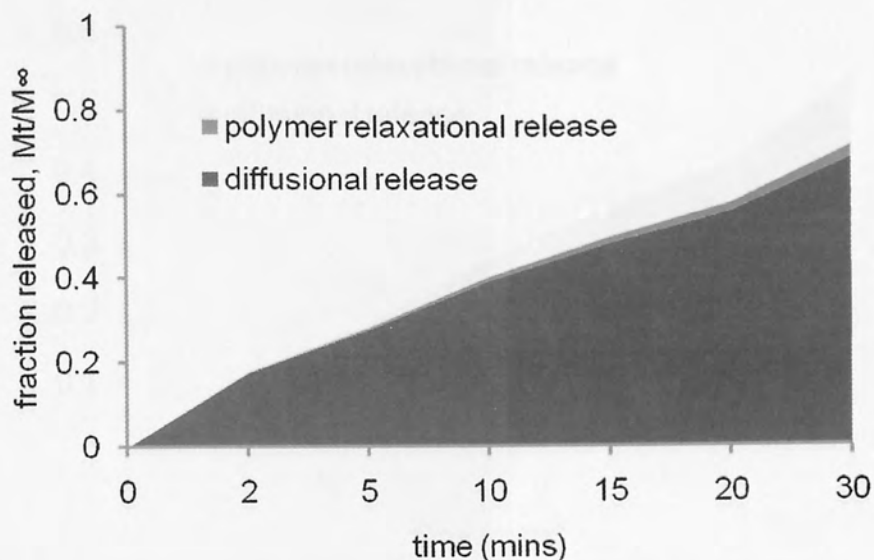

Figure 3.20: The contributions of Fickian diffusion and polymeric relaxation in the drug release from HPMC (100cps) film containing 10%v/v glycerol (data shows means \pm S.D., $n=4$)

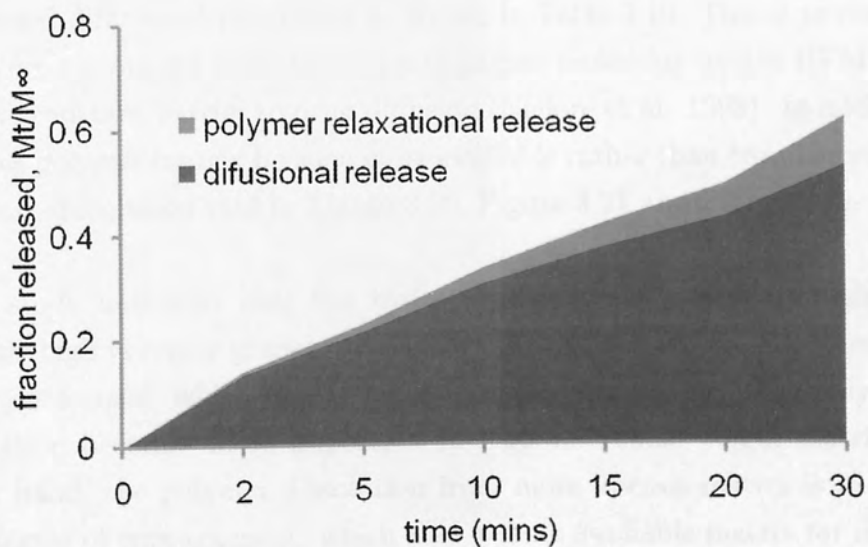

Figure 3.21: The contributions of Fickian diffusion and polymeric relaxation in the drug release from HPMC (4,000cps) film containing 10%v/v glycerol (data shows means \pm S.D., $n=4$)

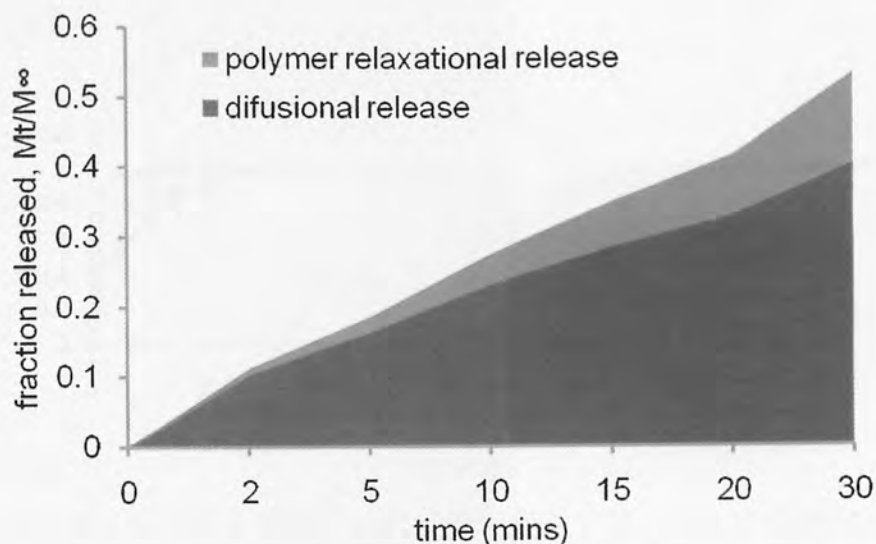

Figure 3.22: The contributions of Fickian diffusion and polymeric relaxation in the drug release from HPMC (15,000cps) film containing 10%v/v glycerol (data shows means \pm S.D., $n=4$)

decreased diffusional parameter k_1 shown in Table 3.10. This is probably due to the more viscous gel layer formed with higher molecular weight HPMC provided a more resistant barrier to drug diffusion (Nellore et al. 1998). In addition, more viscous polymer matrix became more swellable rather than erodible with reduced polymer dissolution rate in Figure 3.20, Figure 3.21 and Figure 3.22.

This study indicated that the hydrophilic polymer matrix at high molecular weight (high viscosity grade) will reduce the drug release rate due to more viscous gel layer formed, which limits the drug diffusional release. The polymer chains relaxation becomes more important in high molecular weight matrix. On the other hand, the polymer dissolution from more viscous matrix is slower due to the degree of entanglement, which lead a more swellable matrix for further drug release control.

With increasing glycerol content in HPMC films, the drug release rate was reduced from all films as seen the value of k in Table 3.10, with the exception of a

3.3 Results and Discussion

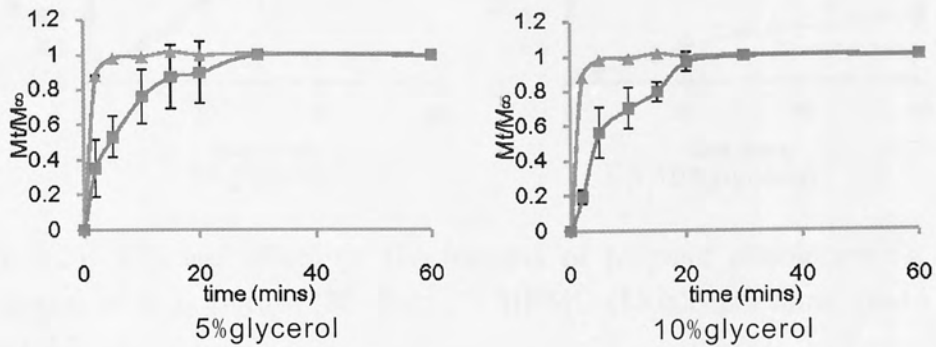

Figure 3.23: Glycerol effect on the fraction of polymer dissolution (▲) and the fraction of drug release (■) from 2% HPMC (100cps) films; (data shows means \pm S.D., $n=4$)

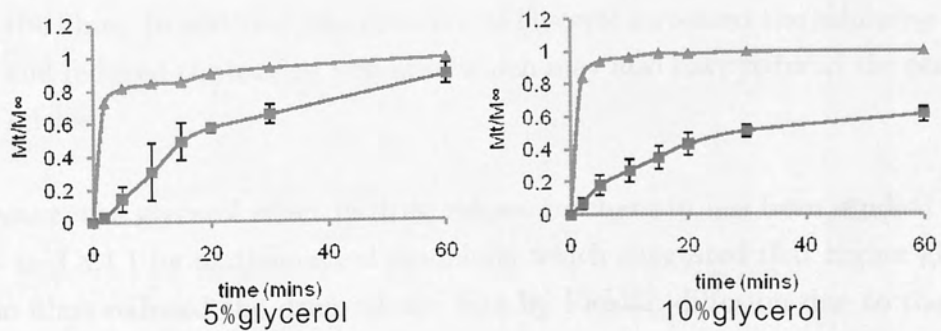

Figure 3.24: Glycerol effect on the fraction of polymer dissolution (▲) and the fraction of drug release (■) from 2% HPMC (4,000cps) films; (data shows means \pm S.D., $n=4$)

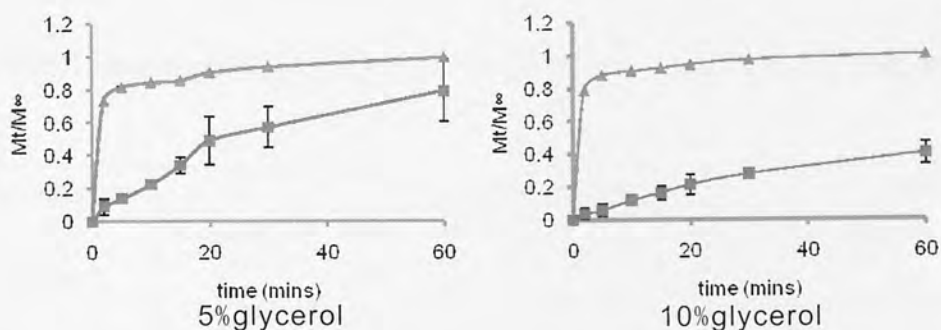

Figure 3.25: Glycerol effect on the fraction of polymer dissolution (\blacktriangle) and the fraction of drug release (\blacksquare) from 2% HPMC (15,000cps) films; (data shows means \pm S.D., $n=4$)

slightly increased k value for M-MW/HPMC (4,000cps grade) films. However, as shown in Figure 3.23, Figure 3.24 and Figure 3.25, the greater glycerol presented in the film vehicles limited the speed of drug release in all cases. However, glycerol showed low effects in the polymer dissolution rates, as in all cases there was rapid polymer dissolution regardless of the glycerol content. As the polymer dissolution corresponded to the contribution of polymer relaxation controlled drug release, it indicated that the reduced drug release with greater glycerol was related to the limitation of drug diffusion rather than the polymer relaxational drug release from the films. In addition, the presence of glycerol increased the solubility of the drug and reduced the leaving potential which may also have reduced the observed drug release.

Moreover, the glycerol effect in drug release mechanism has been studied previously in 3.3.4.1 by mathematical modeling, which suggested that higher glycerol in the films reduced the drug release rate by Fickian diffusion due to the more viscous layer formed around the matrix during hydration.

3.3.5 MIC study of buccal films

The efficacy of all formulations was studied in this section. The dilution series of films and original films were investigated with a sample containing *Candida* cells in acetate buffer as a positive control. The scores of visible fungal growth are

3.3 Results and Discussion

Table 3.11: Scores of MIC study; the original formulation containing 5mg/mL MN ($n=6$)

Formulation ID	Cell control	Formulation dilution series							MIC (mg/cm ³)
		1:1	1:2	1:4	1:8	1:16	1:32	1:64	
MC2G5	4	0	0	1	2	2	2	2	2.5
MC2G10	4	0	0	0	1	2	2	2	1.25
MC4G5	4	0	0	0	1	1	2	2	1.25
MC4G10	4	0	0	0	0	1	1	1	0.625
HEC4G5	4	0	0	0	1	2	3	3	1.25
HEC4G10	4	0	0	0	0	2	2	2	0.625
HEC6G5	4	0	0	1	1	2	3	3	2.5
HEC6G10	4	0	0	1	1	2	3	3	2.5
HPMC6G5	4	0	0	1	2	2	2	2	2.5
HPMC6G10	4	0	0	1	1	1	2	2	2.5
HPMC8G5	4	0	0	1	1	1	1	1	2.5
HPMC8G10	4	0	0	1	1	1	1	1	2.5

shown on Table 3.11.

When the polymer and glycerol concentration increased, the action of drug was increased in films prepared with MC. At higher glycerol concentration, more drug was dissolved rather than dispersed, which lead to a lower MIC. On the other hand, as overall concentration of polymer increased, the release of drug was hindered leading to a higher MIC value.

In studied films, the most active formulations against *Candida albicans* demonstrated MIC at 0.625mg/cm³ with formulations MC4G10 and HEC4G10. The MIC for all HPMC formulated films was at 2.5mg/cm³, this may be higher than with other formulations due to the comparatively slow release of drug from this polymer.

3.4 Chapter Summary and Conclusions

3.4.1 Orally retained films drug release mechanisms

In this study, the potential of orally retained films formulated from cellulose derivatives for local delivery of antifungal agents to both the oral cavity and oesophagus was demonstrated. All films prepared demonstrated appropriate mechanical properties for an orally retained film with potential to deliver a unit dose of an antifungal drug.

The contribution of polymer relaxation in the drug release became more important over time and the trend of increasing polymer relaxation fraction release showed in all films. All films prepared with higher glycerol content demonstrated more flexible and swelling control behaviors, moreover, more glycerol in the hydrophilic matrix provided a good drug release control with an increasing contribution of polymer relaxation in drug release, which is desirable for oral dissolving dosage forms targeting the oesophagus. For the study where the molecular weight of HPMC was varied, the polymer dissolution data clearly showed that as the glycerol loading was increased from 5 to 10 %v/v, there was a greater disparity in the release of drug and polymer; however, this trend was not clear from the mathematical modelling data thus suggesting that measurement of polymer dissolution is required to note the release rate of both drug and polymer. For the more hydrophilic polymers, such as HEC and HPMC films in this study, increasing the polymer content also prolonged drug release with polymer relaxational drug release, which provides advantages in the formulation design targeting the oesophagus. The mechanism of drug release in all cases was determined to be predominantly Fickian according to the mathematical models used. However, according to the polymer dissolution study, the results found from mathematical models that gave polymer relaxational controlled release did not show concomitant polymer and drug release.

Therefore, the drug release mechanism from hydrophilic matrix can not be rely on the mathematical models alone and the measurement of polymer dissolution

3.4 Chapter Summary and Conclusions

is necessary. Films prepared from HPMC exhibited sustained drug release with concurrent dissolution of the polymer, offering a unit dosage form for drug delivery for immediate release, especially in higher molecular weight grade, so these were found to be the most appropriate for controlled drug delivery to the oral cavity and oesophagus.

Chapter 4

Orally Retained Tablet for Oesophageal Drug Delivery

4.1 Introduction

In the past few years, there has been a steady rise in the use of orally retained tablets. The orally retained tablet is a dosage form which is designed to be held in the oral cavity for a period of time, during which it releases the drug by diffusion through the oral mucosa. These hydrophilic polymers are used in the form of tablets with a suitable and suitable excipients to form a matrix. The matrix of the orally retained tablet is made of hydrophilic polymers, which are used to control the drug release. To explore the factors that may affect drug release from these hydrophilic matrices, the following objectives were set:

- To investigate the effect of drug release mechanism from the hydrophilic matrix.
- To compare the experimental polymer dissolution from the orally retained tablet with the drug release mechanism from mathematical models for an insight into the mechanism of drug release.

Chapter 4

Orally Retained Tablet for Oesophageal Drug Delivery

4.1 Introduction

In this chapter, tablets were developed as orally retained dosage forms to investigate the oesophageal drug delivery potential. The orally retained tablets investigated in this study were designed to be small with some bioadhesive properties so that they could be retained in position by adherence with the oral mucosa during drinking and speaking without major discomfort. Three hydrophilic polymers were employed as the main matrix components with swellable and erodible behaviors in order to increase the viscosity of the saliva during oral retention thereby benefiting local drug delivery targeting the oesophagus. To explore the factors that may affect drug release kinetics from these hydrophilic matrices, the following objectives were set:

- To mathematically model the drug release mechanism from the hydrophilic matrix;
- To compare the experimental polymer dissolution from microviscometry with the drug release mechanism from mathematical models for an insight into the mechanism of drug release;

- To investigate the effect of the addition of Carbopol® in controlling the drug release behavior;
- To compare the drug loading effect in the matrix system;
- To measure the effect of lactose as an excipient in the drug release mechanism.

4.2 Materials and Methods

4.2.1 Materials

Most of the chemical materials were as the same as described previously in section 3.2.1 of films chapter. In addition, the α -lactose purchased from Sigma, UK was used as diluents in tablet formulations. Carbopol®974P generously donated by Noveon was added as a release-controlling excipient. Phosphate buffered saline (PBS) (pH7.4) tablets and sodium dodecyl sulphate (SDS) from Sigma were used as medium for tablet dissolution testing. All other chemicals used were purchased from Sigma, UK and were used as received.

4.2.2 Direct compression tableting

A direct compression method was applied for tablet preparation using a Specac® die press. Tablets (total tablet mass was 50mg) were prepared according to the compositions listed in Table 4.1. The compositions containing only the polymers and the drug were control tablets to note the effect of each polymer on drug release kinetics. The compositions where 5mg Carbopol®974P replaced of same amount of the polymer compared to the control were developed to enable the effect of Carbopol® to be investigated. Also, the effect of lactose in the formulations was investigated with the tablets containing 50%w/w lactose whilst keeping the ratio of the polymer and the drug at 4:1 as the same as the tablet control. In addition, with the constant lactose, the tablets at the reverse ratio of the polymer and the drug (1:4) were also investigated. For each batch of formulation, all of the contents were weighed individually and mixed well, then finally compressed under

4.2 Materials and Methods

Table 4.1: The variable composition of tablets for the effects on drug release study

Objective & Formulation ID	Composition of the tablet (50mg in total)			
	Polymer	Carbopol®974P	Lactose	Miconazole
Formulation control	(mg)	(mg)	(mg)	(mg)
MC40	40	-	-	10
HEC40	40	-	-	10
HPMC40	40	-	-	10
	Polymer	Carbopol®974P	Lactose	Miconazole
Carbopol®974P effect	(mg)	(mg)	(mg)	(mg)
MC35/CP5	35	5	-	10
HEC35/CP5	35	5	-	10
HPMC35/CP5	35	5	-	10
	Polymer	Carbopol®974P	Lactose	Miconazole
Lactose effect	(mg)	(mg)	(mg)	(mg)
MC20/L25	20	-	25	5
HEC20/L25	20	-	25	5
HPMC20/L25	20	-	25	5
hline	Polymer	Carbopol®974P	Lactose	Miconazole
Drug loading effect	(mg)	(mg)	(mg)	(mg)
MC5/MN20	5	-	25	20
HEC5/MN20	5	-	25	20
HPMC5/MN20	5	-	25	20

2 tons pressure for 4 minutes using the Specac KBr press with a 5mm diameter die. 20 tablets were prepared from each batch and stored at room temperature until required and all were used within 3 months of preparation.

4.2.3 Drug dissolution apparatus

In vitro drug release studies were carried out using standard USP dissolution apparatus adapted for small volumes, with baskets rotating at a speed of 50 rpm, in 200mL dissolution medium maintained at $37\pm 0.1^\circ\text{C}$. Due to the low solubility of miconazole nitrate, the dissolution medium was prepared using 1%w/v SDS in PBS buffed saline at pH7.4.

At set time intervals, 3mL of dissolution media was removed for analysis, this volume was replaced with fresh medium and this factor was taken into account in all calculations. 1mL of each 3mL sample was then filtered through $0.45\mu\text{m}$ cellulose acetate membrane prior to analysis *via* HPLC as described previously in section 3.2.2. The other 2mL sample was used for polymer dissolution study analyzed by microviscometry. The release profiles were obtained by plotting the fraction of miconazole nitrate released versus time; the experiment was performed six times for each formulation.

4.2.3.1 Analysis of drug release data

GraphPad Prism, version 4 was used to plot the fraction of drug released versus time, this was fitted to a power function, Equation 3.1, to determine the values of n and k . Where anomalous release was demonstrated $0.45 < n < 0.89$ the data were further fitted to Equation 3.2 using GraphPad Prism (Version 4) to determine the values of k_1 and k_2 , where m was fixed as 0.45 due to the geometry of the tablet (Peppas & Sahlin 1989). For each fit the regression coefficient r^2 was also recorded indicating the goodness of fit.

4.2.4 Polymer dissolution from orally retained tablets

The polymer dissolution from tablets was determined by microviscometer. As mentioned in previous chapter, the presence of the dissolved polymer was the only factor that influenced the viscosity of the dissolution medium. Therefore, the dilutions of the standard polymer solution were prepared for the calibration curves. The pure polymer standard solutions were prepared in PBS saline at pH7.4 with 10% SDS to match the dissolution medium and the viscosities of the dilutions were determined by microviscometer. Calibrations for all polymers over the concentration were performed demonstrating the linearity of the relationship between concentration and viscosity over the range. An Anton Paar microviscometer that measures viscosity according to the rolling ball principle was used throughout.

4.2.5 Statistical analysis

Statistical analysis was performed as described in section 2.2.8.

4.3 Results and Discussion

4.3.1 Linear calibrations of celluloses

All three celluloses in this study demonstrated the linear behaviors of viscosity against the concentration of the polymers with linear regression values of $r^2 > 0.999$ as shown in Figure 4.1 (MC), Figure 4.2 (HEC), and Figure 4.3 (HPMC). Therefore, the polymer dissolution study was measurable according to the calibrations to evaluate and compare the kinetics of polymer dissolution from all tablet matrices.

4.3.2 Drug release from pure polymeric tablets

In this study, all of the drug release data from 4 experimental repetitions of formulations were fitted to Peppas equations (Equation 3.1 and 3.2 respectively). From the equations, M_t/M_∞ is the drug fraction released at time t , which the

4.3 Results and Discussion

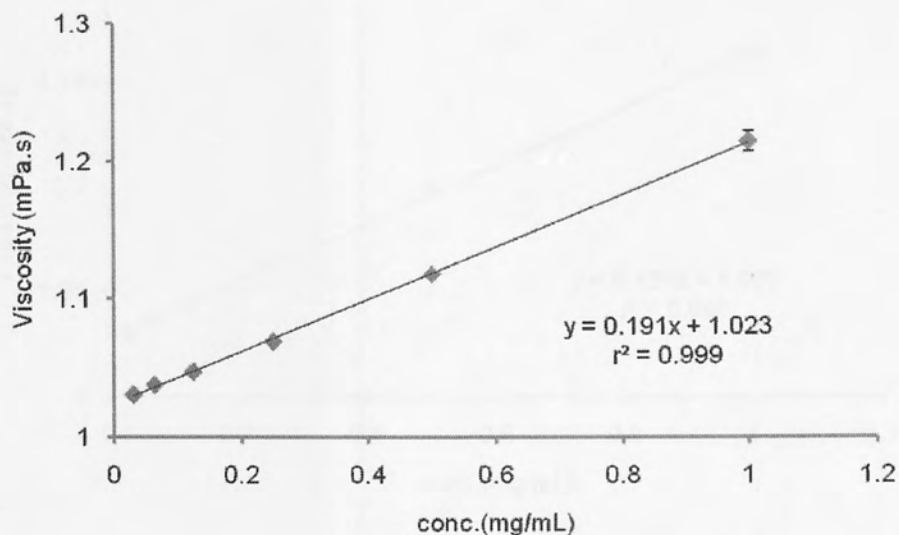

Figure 4.1: Calibration curve of MC using microviscometry assay with the series of concentration from 0.003125 to 1mg/mL (data shows means \pm S.D., $n=4$)

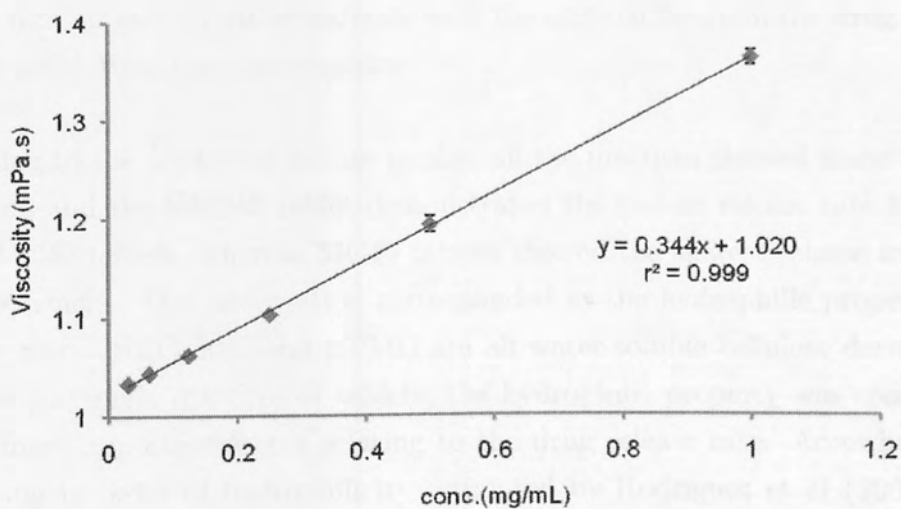

Figure 4.2: Calibration curve of HEC using microviscometry assay with the series of concentration from 0.003125 to 1mg/mL (data shows means \pm S.D., $n=4$)

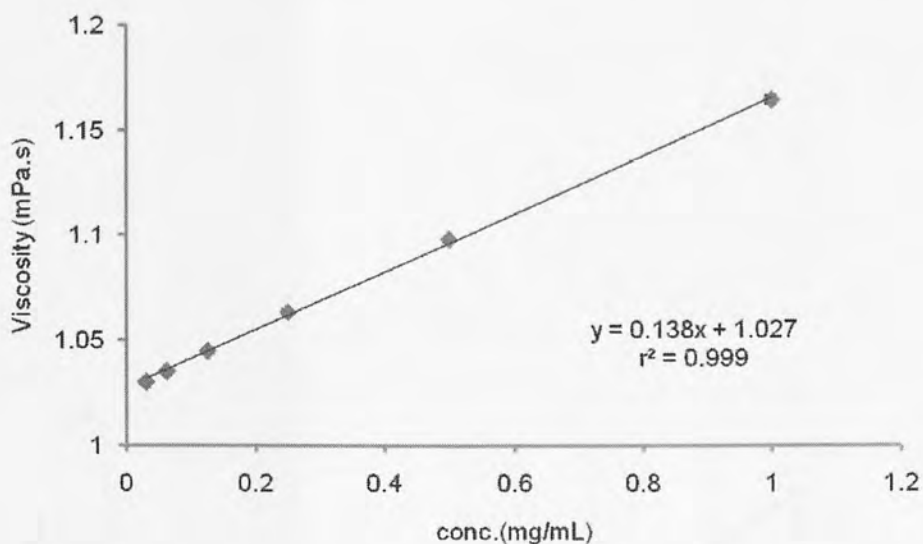

Figure 4.3: Calibration curve of HPMC using microviscometry assay with the series of concentration from 0.003125 to 1mg/mL (data shows means \pm S.D., $n=4$)

drug fraction release profile could be converted from the percentage of drug release. Figure 4.4 showed typically profiles of the fractional drug release from MC40, HEC40 and HPMC40 tablets, with the original figure of the drug release percentage at time t as the reference.

According to the fractional release profile, all the matrices showed linear release behaviors and the HEC40 tablet demonstrated the fastest release rate followed by HPMC40 tablets, whereas MC40 tablets showed the slowest release from the three polymers. This observation corresponded to the hydrophilic properties of the polymers. HEC, MC and HPMC are all water-soluble cellulose derivatives. As pure polymeric matrices of tablets, the hydrophilic property was considered as the most important factor relating to the drug release rate. According to a decreasing in order of hydrophilicity estimated by Rodriguez et al (2000), the tablet matrices is following this order with HEC most hydrophilic and MC the least.

Table 4.2 shows the theoretical data fitted from the experimental data of MC40,

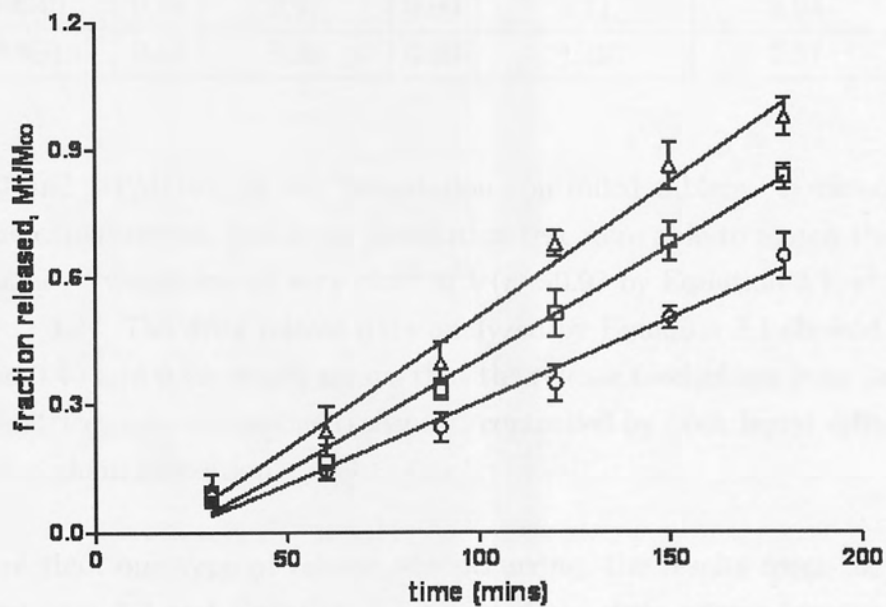

Figure 4.4: Fractional release of miconazole nitrate from HPMC40 tablet (\square); MC40 tablet (\circ); HEC40 tablet (Δ); Lines represent fitted data according to Equation 3.1 (data shows means \pm S.D., $n=4$)

4.3 Results and Discussion

Table 4.2: Diffusional coefficient, n and release constant k (Equation 3.1); diffusional (k_1) and relaxational (k_2) kinetic constants (Equation 3.2) and the correlation coefficient (r^2) for drug release from each tablet with different polymer content (data shows means \pm S.D., $n=4$)

Formulation ID	n	k ($t^{-n} \times 10^{-3}$)	r^2	k_1 ($t^{-0.45} \times 10^{-3}$)	k_2 ($t^{-0.9} \times 10^{-3}$)	r^2
MC40	0.78	12.04	0.97	17.75	4.58	0.98
HEC40	0.88	9.97	0.99	2.71	8.94	0.99
HPMC40	0.88	8.89	0.99	4.49	7.37	0.99

HEC40 and HPMC40, as the formulation controlled tablets. It demonstrated that the experimental data from dissolution test were able to match the Peppas Models, as r^2 values are all very close to 1 ($r^2 > 0.97$ by Equation 3.1, $r^2 > 0.98$ by Equation 3.2). The drug release data analyzed by Equation 3.1 showed n values between 0.45 and 0.89, which means that the release mechanism from pure polymeric matrices was anomalous transport, controlled by both liquid diffusion and polymeric chain relaxation.

As more than one type of release was occurring, the results from the alternative Equation 3.2 and Equation 3.3 explored the drug release kinetics further. According to the diffusional (k_1) and relaxational (k_2) kinetic constants in Table 4.2, the fractional extents of the drug release due to Fickian diffusion mechanism were shown in Figure 4.5 by using Equation 3.3. The drug release from HEC40 and HPMC40 tablets showed a greater contribution from polymeric relaxation controlled kinetics, in compared with MC40 tablets with relative high Fickian diffusion. In addition, it was quite obvious that drug release from all tablets tended to be more affected by the increasing rate of polymer chain relaxation with decreasing F values from MC through to the most hydrophilic HEC.

When the hydrophilic matrix was in contact with an aqueous medium, the polymer particles on the surface of the tablet are hydrated immediately. With the

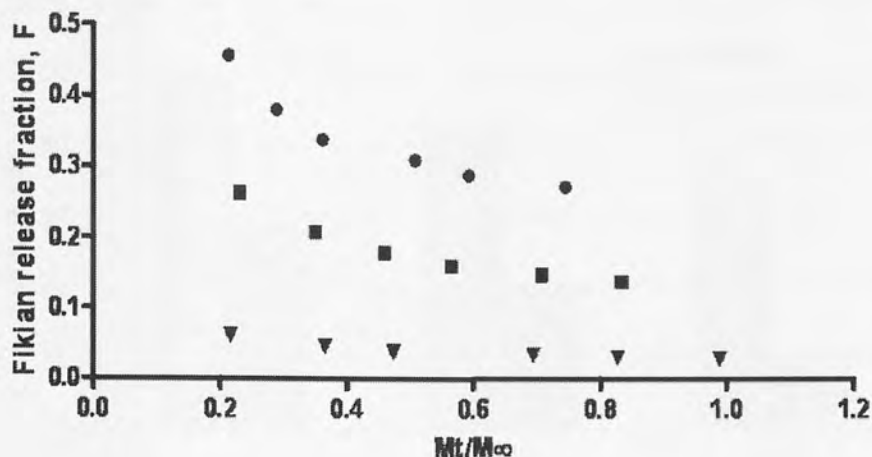

Figure 4.5: Fickian release fraction as a function of released miconazole from pure polymeric tablets; MC40 (●); HPMC40 (■); HEC40 (▼) (data shows means \pm S.D., $n=4$)

continuing water-uptake, the very hydrophilic polymer was dissolved due to the weakened hydrogen bonding between the polymeric molecules; therefore most of the drug particles can diffuse easily from the eroded matrix. As shown in Figure 4.5, the drug release from HEC40 tablet was least diffusion-controlled system followed by HPMC40 tablet due to the highly water soluble behaviors of HEC and HPMC resulting in a very fast relaxation rate of polymer chains.

On the other hand, some hydrophilic polymers could be considered as water-swelling rather than water-soluble polymer due to the nature of strongly entangled and penetrated chains. When the tablets prepared with those polymers are put into the water, a hydrogel layer will be formed on the surface of the tablet. Thus, the drug molecules in this stage would be mainly diffused from the matrix due to a high concentration gradient. In addition, the water-uptake into the matrix disrupts the polymer network assisting in drug diffusion. Compared to HEC and HPMC, methyl cellulose (MC) in this study showed good swelling-controlled properties with an F value starting at a higher level; however, over time the contribution of polymer relaxation to drug release increased as the polymer chains

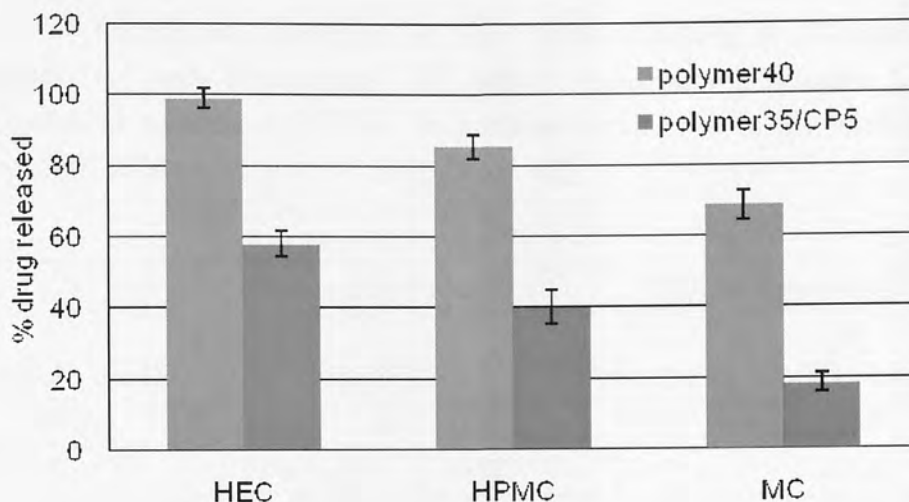

Figure 4.6: The effect of Carbopol[®]974P on the percentage of miconazole release after 180 minutes: the tablet containing 40mg polymer as control (■); the tablets added with 5mg Carbopol[®]974P (■) (data shows means \pm S.D., $n=4$)

were hydrated.

4.3.3 Effect of the additional release controlling excipients

As shown in Figure 4.6, when Carbopol[®]974P was introduced into the formulation at 10%w/w, it reduced the extent of drug release from all formulations due to its release-controlling property (Mohammadi-Samani et al. 2005). The drug release from HEC35/CP5 tablet was faster with 58% released after 3 hours, due to the very hydrophilic behaviour. MC tablets showed very low release when 10%w/w Carbopol[®]974P was included, only 18% of drug was released after 3 hours.

When Carbopol[®]974P was incorporated into the tablets in addition to lactose such that the relative level of cellulose derivative polymer was reduced compared to the control (cellulose polymer 40%, lactose 40%, carbopol[®]974P 10% and drug 10%), the drug release mechanism from all tablets became more controlled

4.3 Results and Discussion

Table 4.3: Diffusional coefficient, n and release constant k (Equation 3.1); diffusional (k_1) and relaxational (k_2) kinetic constants (Equation 3.2) and the correlation coefficient (r^2) for drug release from each tablet with/without Carbopol®974P (data shows means \pm S.D., $n=4$)

Formulation ID	Peppas Equation 3.1			Peppas Equation 3.2		
	n	k $t \times 10^3$	r^2	k_1 $(t^{-0.45} \times 10^{-3})$	k_2 $(t^{-0.9} \times 10^{-3})$	r^2
MC40	0.78	12.04	0.97	17.75	4.58	0.98
MC35/CP5	0.66	6.16	0.97	11.07	0.64	0.96
MC15/CP5/L20	0.48	32.39	0.98	33.77	0.38	0.98
HEC40	0.88	9.97	0.99	2.71	8.94	1.00
HEC35/CP5	0.85	7.15	0.99	4.75	5.05	1.00
HEC15/CP5/L20	0.58	18.66	0.99	23.61	1.29	0.99
HPMC40	0.88	8.89	0.99	4.49	7.37	1.00
HPMC35/CP5	0.82	5.60	0.99	5.11	3.29	1.00
HPMC15/CP5/L20	0.61	17.05	0.98	22.28	1.62	0.99

by Fickian diffusion with significantly increased n value shown in Table 4.3. It identified that Carbopol®974P played an effective role in diffusion drug release mechanism in the hydrophilic matrices, with greater effects in conjunction with the very water-soluble polymeric matrices.

4.3.4 Drug release behavior affected by the diluents

In this study, lactose as a widely used diluent was investigated with respect to its influence on release from the hydrophilic matrix. Compared to MC40, HEC40 and HPMC40 tablets as the formulation control, the tablets with 50%w/w lactose were prepared by keeping the same ratio of the polymer and the drug in the tablets (Table 4.1). Lactose, as a diluent in a hydrophilic polymeric matrix can stimulate water penetration into the inner parts of the matrix, thus resulting in diffusion control of drug release (Huang et al. 2004). As seen from Figure 4.7, a

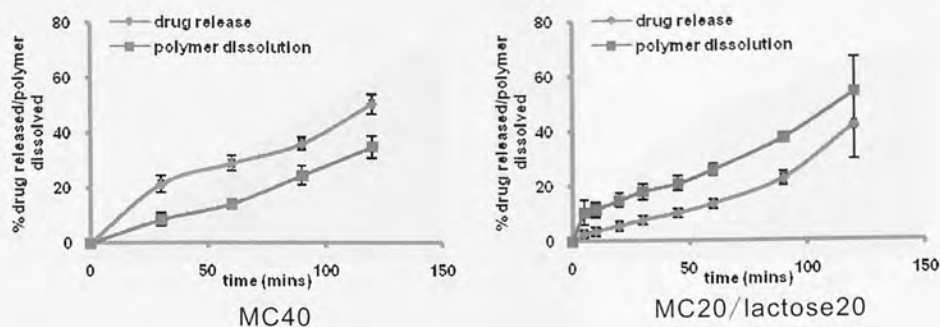

Figure 4.7: The lactose effect in polymer dissolution from MC tablets (data shows means \pm S.D., $n=4$)

greater polymer dissolution rate from the MC matrix with lactose suggested that a major polymer relaxational release effect was observed in MC lactose-loaded matrices in comparison to the pure polymer tablet. Therefore, it is indicated that lactose present in MC tablet improved the water penetration, which provided more erodible rather than swellable matrix with decreased diffusional drug release. On the contrary, incorporation of the diluent reduced the drug release rate from the more hydrophilic matrices (HEC and HPMC tablets respectively) as shown in Figure 4.8 and Figure 4.9.

As mentioned previously, HEC and HPMC are very hydrophilic polymers. When lactose was added, it improved the water penetration into the polymeric network, resulting in a very quick dissolving as the matrix prepared with HEC and HPMC respectively (Figure 4.10 and Figure 4.11). Therefore, the solid drug particles were left in the dissolution medium and dissolved slowly following the mechanism of solids dissolution from liquids, which was corresponded to Fickian diffusional drug release fraction. Whereas, the pure HEC and HPMC matrices showed faster drug release due to the additional drug release controlled by the similar polymer dissolving rate.

4.3.5 Drug loading effect on the release kinetics

Increased drug content resulted in an increase in the diffusional control of drug release from the tablets prepared with more hydrophilic polymers (HPMC and

4.3 Results and Discussion

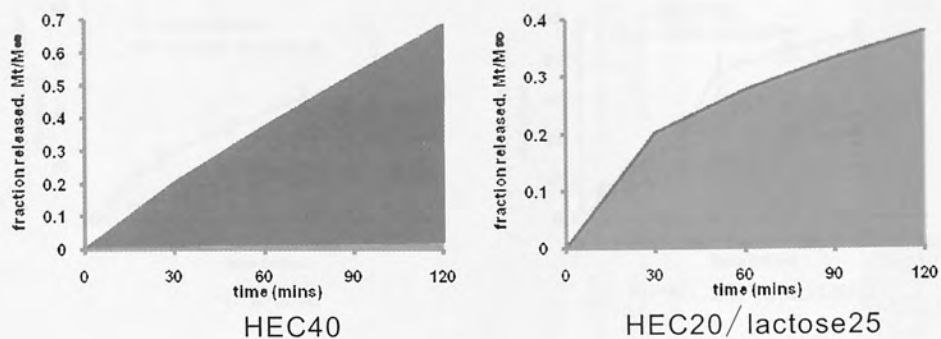

Figure 4.8: The lactose effect in contributions of Fickian diffusion and polymeric relaxation in the drug release from HEC tablets (data shows means \pm S.D., $n=4$)

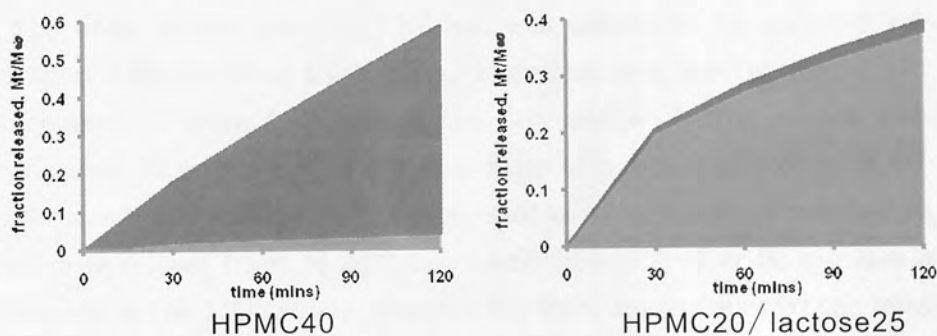

Figure 4.9: The lactose effect in contributions of Fickian diffusion and polymeric relaxation in the drug release from HPMC tablets (data shows means \pm S.D., $n=4$)

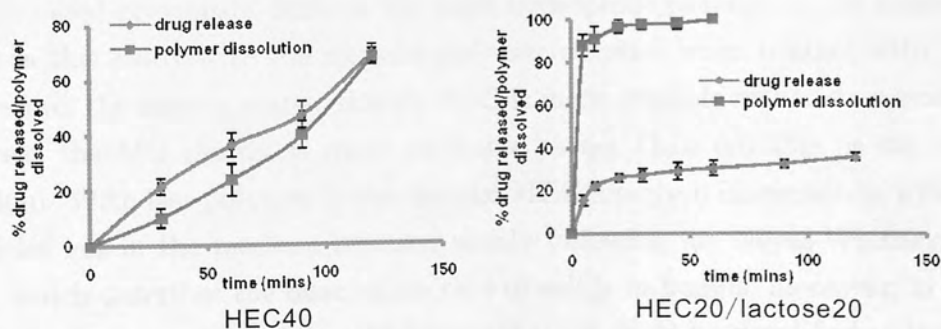

Figure 4.10: The comparison of drug release and polymer dissolution from HEC tablets with/without lactose (data shows means \pm S.D., $n=4$)

4.3 Results and Discussion

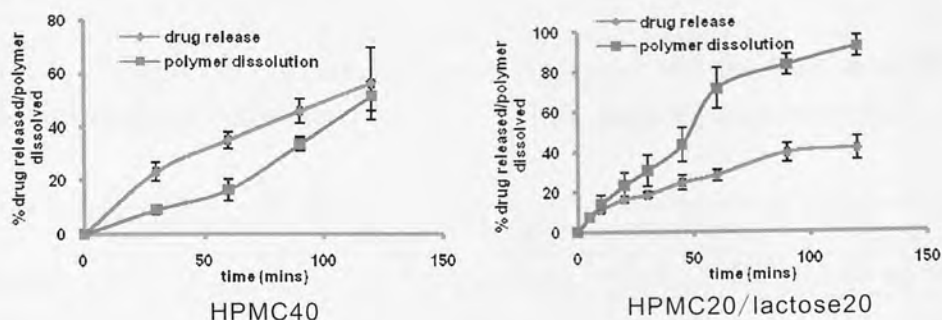

Figure 4.11: The comparison of drug release and polymer dissolution from HPMC tablets with/without lactose (data shows means \pm S.D., $n=4$)

HEC), with an increased diffusional release fraction (F) shown in Table 4.4. However, the drug release from MC tablets was controlled by polymer relaxation rather than diffusion from the matrix, when the drug loading in the MC tablet was increased. Figure 4.12 showed the percentage of drug release from three matrices after 90 minutes with different ratio of polymer and drug at 4:1 (w/w) and 1:4 (w/w) respectively. More relaxational release control resulted in an increased drug release from $26.2 \pm 2.33\%$ to $60.3 \pm 4.11\%$ after 90 minutes as more drug loading in the MC tablets; whereas the HEC matrix showed the lowest drug release at $20.2 \pm 1.17\%$ after 90 minutes. When the drug content was increased, the polymer matrix was diluted, which resulted in a weakened polymer chain interactions during hydration.

As discussed previously, HEC is the most hydrophilic polymer of the three polymers in this study with the weakest polymer network when contact with water. Therefore, the matrix prepared with HEC is more erodible rather than swellable, whereas the MC matrix is more swellable rather than erodible in the release medium. With less polymer in the matrix, HEC dissolved immediately with drug particles left in the medium released slowly following the Noyes-Whitney equation, which describes the dissolution rate of solids in liquids; moreover, as under the sink conditions, the Noyes-Whitney equation could be simplified as the same as the Fickian equation.

4.3 Results and Discussion

Table 4.4: The effect of the ratio between the polymer and the drug on the fraction of released drug by diffusional control ($r^2 > 0.95$, data shows means \pm S.D., $n=4$)

Time (mins)	Fickian Release Fraction, F					
	MC: Drug (w/w)		HEC: Drug (w/w)		HPMC: Drug (w/w)	
	4:1 ($r^2=0.98$)	1:4 ($r^2=0.96$)	4:1 ($r^2=0.99$)	1:4 ($r^2=0.95$)	4:1 ($r^2=0.99$)	1:4 ($r^2=0.96$)
30	0.46	4.13E-06	0.06	0.65	0.26	0.83
60	0.38	3.02E-06	0.05	0.58	0.21	0.79
90	0.34	2.21E-06	0.04	0.50	0.18	0.73
120	0.31	1.84E-06	0.04	0.50	0.18	0.73
150	0.29	1.35E-06	0.03	0.38	0.15	0.62
180	0.27	1.12E-06	0.03	0.34	0.14	0.58

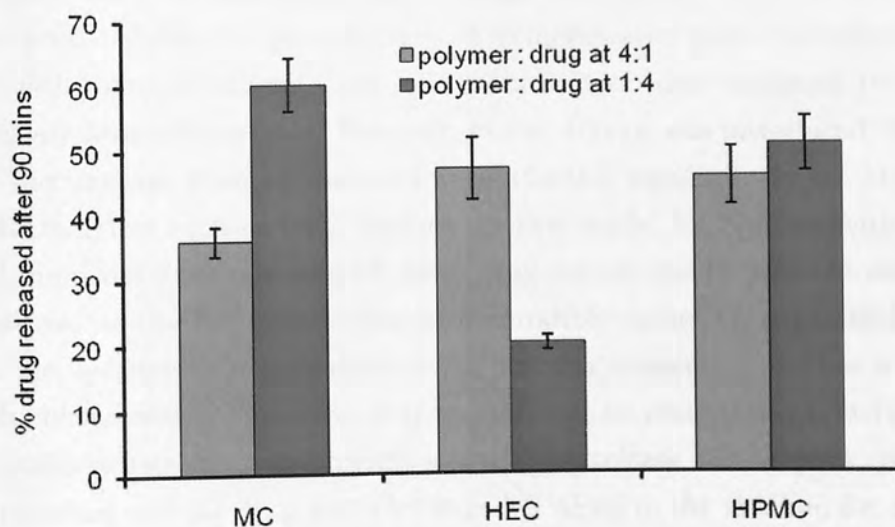

Figure 4.12: The effect of drug loading on the percentage of miconazole release after 90 minutes: the tablet containing polymer and drug at 4:1 (■); the tablets containing polymer and drug at 1:4 (■) (data shows means \pm S.D., $n=4$)

4.4 Chapter Summary and Conclusions

4.4.1 Drug release mechanism from orally retained tablets

The orally retained tablets prepared with the polymers selected in this study showed that the release mechanism was able to demonstrate swelling-controlled release and/or diffusion-controlled release by adjusting the polymer and excipients within the formulation as well as their relative concentrations.

The drug release mechanism of all formulations was characterised using the Peppas Equations and the release data fitted to the model well. The hydrophilic behaviours of the three polymers in this study are different with a decreased order of hydrophilicity at $\text{HEC} > \text{HPMC} > \text{MC}$, which showed important factor on the drug release rate and drug release mechanism from the pure polymeric matrices. As the most hydrophilic polymer, the pure HEC tablets showed more erodible rather than swellable with the fastest drug release behaviour; whereas the MC tablet with no excipients was the most swellable matrix with a slow drug release more controlled by drug diffusion. Moreover, when Carbopol®974P was incorporated into the formulations, it demonstrated good controlled-release ability with more diffusional drug release, and is an ideal excipient to prolong drug release from all matrices. However, as the diluent was introduced, the drug release mechanisms from all matrices were affected, especially in the highly hydrophilic matrices such as HEC tablets. In this study, MC tablets with lactose showed improved drug release with more drug release due to polymer relaxation mechanisms, as the MC matrix was more erodible rather than swellable. Lactose in the hydrophilic matrix diluted the polymer concentration thus weakened the polymer network. Therefore, it is not difficult to understand that HEC and HPMC tablets with diluents brought a slow drug release due to quick dissolving of the matrices and the drug particles were left alone in the medium for diffusion following a Fickian law equation.

As hydrophilic tablets, the relaxation of polymer chains resulted in polymer dissolution, which was advantageous for oesophageal targeting by forming a viscous

4.4 Chapter Summary and Conclusions

solution containing the solubilised drug. All in all, orally erodible tablets prepared with water-soluble celluloses in this study were appropriate for oral cavity application; moreover, the MC tablets were especially suited to oesophageal delivery.

Chapter 5

Chewable Tablets as a Strategy Targeting The Oesophagus and *In Vitro* Dissolution Methods to Evaluate Release from Chewable Tablets

5.1 Introduction

Chewable tablets are designed to be mechanically disintegrated in the mouth. Potential advantages of these tablets include mainly easier swallowing and adherence although enhanced bioavailability is also claimed. This strategy is especially useful for the paediatric population as well as for geriatric and handicapped compared to standard formulae and that oral disintegration in the GI tract. The direct benefit of avoiding alteration for paediatric and geriatric conditions. Chewable tablets are also desirable because they offer convenience for consumers, avoiding the necessity of administration with water. A link between this and the objective of this study is that many pharmaceutical active have an unpleasant taste that also can reduce compliance among patients unless adequately masked with the formulation.

Chapter 5

Chewable Tablets as a Strategy Targeting The Oesophagus and *In Vitro* Dissolution Methods to Evaluate Release from Chewable Tablets

5.1 Introduction

Chewable tablets are designed to be mechanically disintegrated in the mouth. Potential advantages of chewable tablets mainly concern patient convenience and acceptance although enhanced bioavailability is also claimed. This increase in exposure can be due to a rapid onset of action as disintegration is more rapid and complete compared to standard formulations that must disintegrate in the GI tract. The dosage form is an appealing alternative for paediatric and geriatric consumers. Chewable tablets are also desirable because they offer convenience for consumers, avoiding the necessity of co-administration with water. A limitation with this system is that many pharmaceutical actives have an unpleasant bitter taste that can reduce compliance among patients unless adequately masked within the formulation.

As an important tool of formulation development, dissolution testing is used to evaluate the rate and extent of the active substance release from solid or semi-solid dosage forms; moreover, it is used to determine the effects of different factors in the dosage forms, such as the influences of processing, the comparison of variable compositions of the formulation and the effect of different excipients applied in the formulation. An appropriate dissolution test should provide a predictive estimate of the *in vivo* behaviour. However, for oral administration of chewable tablets, it is a challenge to assemble a dissolution apparatus, which could mimic the *in vivo* condition of the oral cavity, due to the small volume of liquid for the medication and a short residence time during application.

Currently, many novel dosage forms for the oral route of administration have been developed, such as buccal tablets, buccal films, lozenges, and chewable tablets, to improve local drug delivery. Recently, a chewable tablet (Zegerid®) containing omeprazole has been approved by FDA for the short-term treatment of heartburn and other symptoms associated with gastroesophageal reflux disease, including the treatment of erosive esophagitis. In this study, miconazole chewable tablets were developed for the treatment of oesophageal infection commonly associated with immunocompromised patients.

As a dosage form, there is no standard dissolution test for chewable tablets. In general, to establish *in vitro* dissolution tests for novel dosage forms, USP (US Pharmacopeia), PhEur (European Pharmacopeia) and PhJap (Japan Pharmacopeia) should be essential guidebooks for reference. Moreover, the development of dissolution tests should follow the conditions, qualifications and validations described in FIP (International Pharmaceutical Federation) and US FDA (US Food and Drug Administration). Currently, several dissolution methods have been described to evaluate the drug release characteristics of chewable tablets using standard USP dissolution apparatus with rotating basket (Suzuki et al. 2003 & 2004) or paddle (El-Gazayerly et al. 2004). Tablets were tested as a whole tablet or crushed pieces. To create a large amount of agitation during chewable tablets dissolution, glass beads were recommended by Siewert et al (2003) to increase agitation within the dissolution medium when using USP dissolution

5.1 Introduction

station. In the European Pharmacopoeia 2005, a dissolution apparatus for chewing gum is described as simulating human chewing behaviour. The apparatus consists of three pistons, which two of them are horizontal position to transmit twisting and pressing forces to the tablet while the third piston located vertically operates alternatively to adjust the tablet stay in the right place as a 'tongue'. However, within these alternative methods, it is still difficult to establish a standard dissolution test for chewable tablets. Development of an appropriate test is still very important which can simulate drug dissolution behaviour *in vivo*, as well as exhibit the influence factors in the dosage forms.

Pillay & Fassihi (1998) have identified the limiting conditions of the rotating basket method for hydrophilic matrices that consist the polymers with high viscosity that swell. The meshes of the basket could prevent the swelling process when the matrices uptake water to a certain extent. Moreover, the mass transfer through the mesh at that stage could be blocked (Wu et al. 2004) and the drug release from the matrices is limited by diffusion mechanism due to inhibition of the polymeric chains relaxation through the basket mesh. Paddle methods known as USP II are normally used for fast release dosage forms. According to recent studies, there is a very weak agitation region directly above the bottom of the vessel called "dead zone". It has been indicated that drug release of the solid dosage forms from dead zone could be reduced due to low fluid flow rate. On the other hand, the tablets could be floating in the dissolution medium of the vessel due to low density of the composition, or disintegrated into small pieces during the dissolution with variable distribution. However, the original release behaviour of the tablets would be affected by the paddle method depending on tablet density, disintegration time of the tablet, different hydrodynamics and variable fluid flow rate in different region of the vessel. Also, it has been highlighted that low rotating speed could cause mixing problems between upper and lower dissolution medium in vessel.

Hard fats are safe additives, commonly used in the chocolate, toffee and confectionery industry. Suzuki et al (2003 & 2004) have employed hard fats as a matrix base in chewable tablets. Moreover, the chewable tablets prepared with hard fats

5.2 Materials and Methods

had a smooth oral feeling during chewing, which is helpful for the patients with swallowing difficulties. Sodium alginate is a viscous, bioadhesive polymer. In the present study, the chewable tablets were prepared with variable ratios of hard fats and sodium alginate as matrix bases. With variable amounts of the excipients in the formulations, the tablets varied from erodible hydrophilic formulations that could stick within the dissolution apparatus to floatable tablets, all factors that need to be considered when selecting an appropriate dissolution test.

In this study, a range of dissolution methods were employed, including standard dissolution tests with rotating basket and paddle method described in USP23, chewing apparatus from PhEur (European Pharmacopeia). To improve the dissolution test, a mesh was assembled under the paddle to ensure the floatable pieces of solid dosage forms were kept within a defined region; moreover, 5g glass beads were added in the bottom of the vessel to improve the agitation as well as to take the tablets away from 'dead zone'.

The objectives of this chapter were:

- To compare the release of both drug and polymer from chewable tablets using a range of dissolution methods previously used within the literature
- To note the effects of the methods used on the rate and mechanism of drug release from the formulation
- To suggest the most appropriate test to use in the further development of a chewable tablet formulation targeting drug to the oesophagus

5.2 Materials and Methods

5.2.1 Materials

Miconazole nitrate (MN) used as a model drug, was purchased from Sigma, UK. Sodium alginate (LF120M kindly donated by FMC BioPolymer), was used as a hydrophilic viscosity enhancing excipient. Witepsol® H15 was used as an excipient to enhance the solubility of miconazole and to improve the mouthfeel during

5.2 Materials and Methods

Table 5.1: The compositions and formulations of chewable tablets ($n=6$)

Formulation ID	Miconazole nitrate (mg)	Sodium alginate (mg)	Fats (Witepsol [®] H15) (mg)	Total weight per tablet (mg)
Control	50	-	1000	1050
A(1:1)	50	500	500	1050
B(3:7)	50	300	700	1050
C(7:3)	50	700	300	1050

chewing. 1%w/v SDS (Sodium dodecyl sulphate) in phosphate buffered saline (PBS) pH7.4 was used for chewable tablet dissolution testing as described in previous sections. All other chemicals used were purchased from Sigma, UK and were used as received.

5.2.2 Preparation of the chewable tablets

Chewable tablets were prepared by direct compression methods. The fats were firstly melted in a mortar at 45°C using a water bath. Miconazole nitrate and sodium alginate were then mixed with melted fats in the mortar by levigation until well mixed. The mixed suspension was then cooled into solid and ground into a fine powder, which was compressed at 5 tons for 4 minutes by single punch tablet machine (Specac KBr) to make a chewable tablet. The compositions and formulations of chewable tablets were listed in Table 5.1. The unit weight was set at 1050mg per tablet, with 50mg miconazole nitrate in each tablet.

5.2.3 Drug release apparatus

5.2.3.1 Rotating basket

Chewable tablets were tested as whole tablet or similar size pieces of crushed tablet using USP dissolution apparatus I. The rotating speed of baskets was set at 50 rpm. 900mL SDS/PBS buffed saline at pH7.4 was used as dissolution

5.2 Materials and Methods

medium maintained at $37\pm 0.5^{\circ}\text{C}$. At set time intervals, 5mL of sample was removed filtered through $0.45\mu\text{m}$ cellulose acetate membrane for analysis. Same volume was replaced with fresh medium and this factor was taken into account in all calculations. Samples were analyzed *via* HPLC as described in section 3.2.2.

5.2.3.2 Paddle method

In this study, USP dissolution apparatus II was used as a reference dissolution method to evaluate the modified paddle apparatus for the chewable tablets in this study. The paddle speed was 200 rpm and 900mL dissolution medium, SDS/PBS buffer at pH7.4 maintained at $37\pm 0.5^{\circ}\text{C}$ was used. 5mL sample was taken at pre-defined time intervals and same volume of buffer was replaced into the dissolution medium.

5.2.3.3 PhEur chewing apparatus

In this study, drug release from chewable tablets was carried out using a specific apparatus described in European Pharmacopoeia 2004 as seen in Figure 5.1. The chewing medium in the chamber was 40mL SDS/PBS buffer at pH7.4 maintained at $37\pm 0.5^{\circ}\text{C}$. 0.5mL of the chewing medium was taken at time points and filtered by $0.45\mu\text{m}$ membrane; while the same volume of buffer saline was replaced into the chamber. The filtrate was diluted 5-fold in volume with fresh buffered saline and analyzed *via* HPLC method, as described in section 3.2.2.

5.2.3.4 Modified paddle apparatus

In this study, USP dissolution apparatus II was modified to test for tablets in this study with floating or sticking tendencies. 5g glass beads, size 4mm in diameter, were added to 900mL dissolution medium (SDS/PBS buffer at pH7.4 maintained at $37\pm 0.5^{\circ}\text{C}$) with paddle at rate of 200 rpm to create more agitation as well as prevent tablet sticking on the bottom of the apparatus (Figure 5.2). Furthermore, a mesh was added ensure the disintegrated tablet pieces were maintained in the simulated fluid flow region. 5mL sample was taken at predetermined time points and the same volume of buffer was replaced into the dissolution medium.



Aston University

Illustration removed for copyright restrictions

Figure 5.1: Schematic diagram of the chewing chamber of an *in vitro* chewing apparatus (Conway & Batchelor 2007)

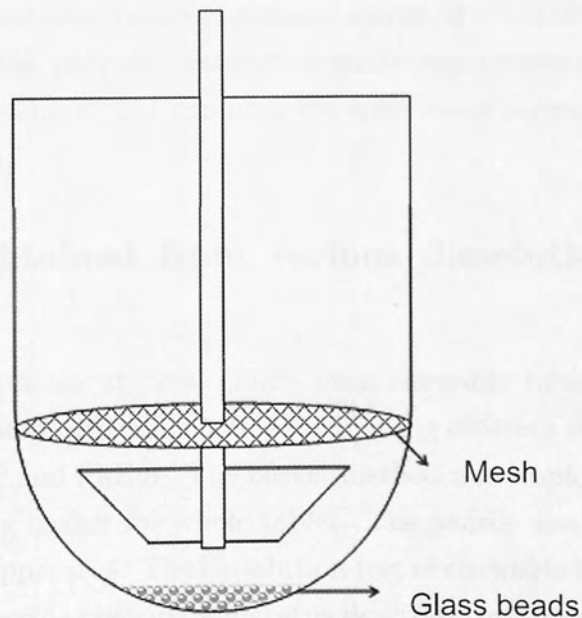

Figure 5.2: Modified paddle apparatus for chewable tablets

5.2.4 Sodium alginate dissolution determined *via* microviscometry

The dissolution of sodium alginate was studied in modified basket method. The determined using microviscometry as mentioned previously in section 4.2.4. The sodium alginate standard solutions were prepared in 1%w/v SDS in PBS saline at pH7.4 and the viscosities of the dilutions were determined by microviscometry. The calibration over the concentration was performed demonstrating the linearity of the relationship between concentration and viscosity over the range. 2mL of 5mL dissolution samples taken at the time point was analyzed *via* microviscometry.

5.3 Results and Discussion

5.3.1 Linear calibrations of sodium alginate viscosity

Sodium alginate demonstrated the linear behaviors of viscosity against the concentration of the polymer with linear regression values of $r^2 > 0.999$ as shown in Figure 5.3. Therefore, the polymer dissolution study was measurable according to the calibrations to evaluate and compare the kinetics of polymer dissolution from all tablet matrices.

5.3.2 Profiles obtained from various dissolution testing methods

Table 5.2 shows drug release at time points from chewable tablets containing sodium alginate and Witepsol®H15 at 1 to 1 ratio, using different standard dissolution apparatus in USP and PhEur. The basket method was employed according to the standard rotating basket for whole tablet. The paddle method was standard USP23 II paddle apparatus. The dissolution test of chewable tablet was also carried out using the specific chewing apparatus described in European Pharmacopoeia 2004 to mimic the chewing behavior of oral application.

From three standard dissolution tests, chewing apparatus showed very fast release within 60 minutes due to the strong agitation during mechanical chewing.

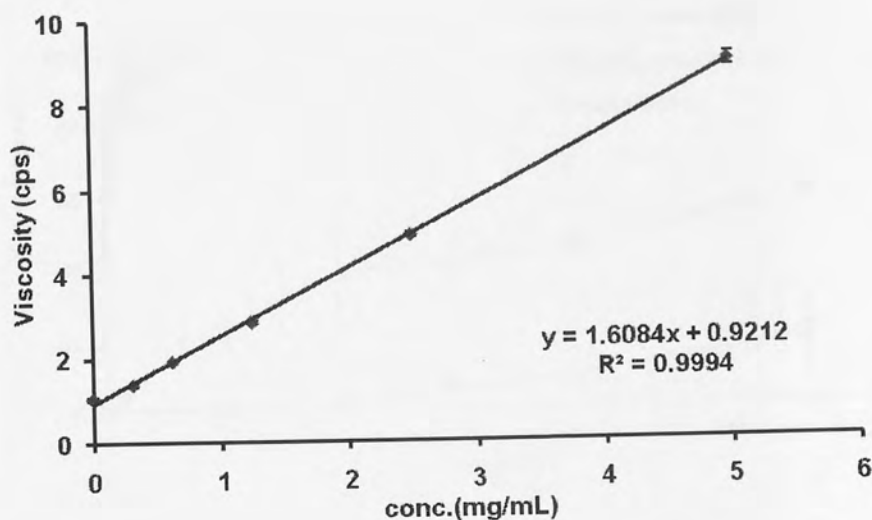

Figure 5.3: Calibration curve of sodium alginate using microviscometry assay with the series of concentration from 0.3125 to 5mg/mL (data shows means \pm S.D., $n=6$)

Table 5.2: Drug release study of chewable tablet containing 500mg sodium alginate and 500mg Witepsol[®]H15 and 50mg miconazole nitrate, using different apparatus: chewing apparatus, rotating basket and, paddle alone (data shows means \pm S.D., $n=6$)

Dissolution apparatus	% drug released at time points using different apparatus				Time for complete release
	30mins	60mins	90mins	180mins	
Chewing apparatus	62.1 \pm 21.19	100 \pm 10.44	100 \pm 5.76	100 \pm 3.35	<60mins
Basket (whole TB)	0.8 \pm 1.93	1.7 \pm 1.67	5.4 \pm 1.3	18.6 \pm 9.98	>12hours
Paddle alone	22.6 \pm 3.92	37.6 \pm 14.03	41.1 \pm 5.13	59.7 \pm 3.50	5 hours

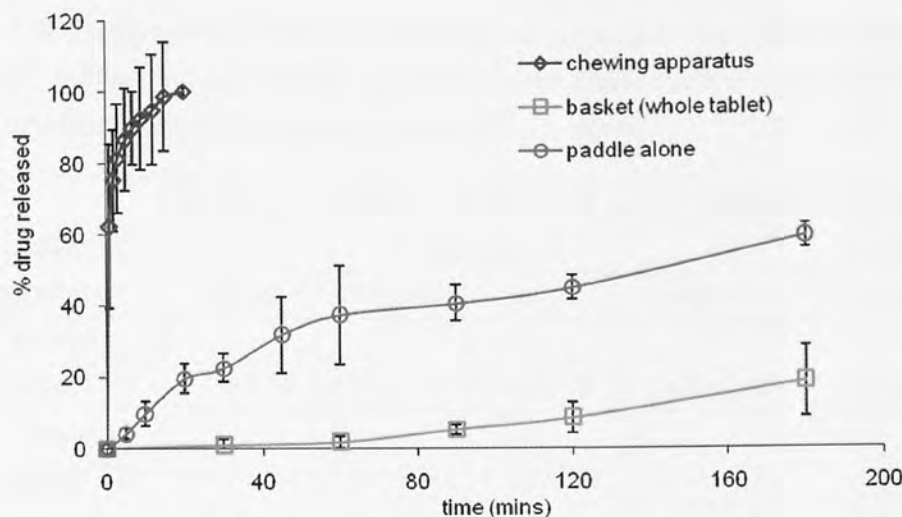

Figure 5.4: Drug release study of chewable tablet containing 500mg sodium alginate and 500mg Witepsol[®]H15, using different apparatus: chewing apparatus, rotating basket and paddle alone (data shows means \pm S.D., $n=6$)

The drug dissolution using paddle methods was faster compared to the long drug dissolution period with basket method (Figure 5.4).

As there is no standard dissolution test for chewable tablet, it is very important to investigate and establish the appropriate method, which should be sensitive to small changes in dissolution rate as well as accurate and repeatable. Therefore, the performance of the various dissolution testing has been studied respectively to explore the factors of *in vitro* drug dissolution rate influence.

5.3.3 Profiles obtained from basket method

The USP rotating basket method has been reported to inhibit the three-dimensional swelling process of the swellable delivery system, which tend to expand greater than the space of the basket (Pillay & Fassihi 1998). The swelling and erosion process of sodium alginate in the chewable tablet and subsequent release into the dissolution medium might be limited. Therefore, the dissolution of chewable tablet was tested using whole tablet using the USP23 basket method and crushed

5.3 Results and Discussion

Table 5.3: Drug release study of chewable tablet containing 500mg sodium alginate and 500mg Witepsol®H15 in whole tablet and crushed pieces respectively, using rotating basket (data shows means±S.D., n=6)

Dissolution apparatus	% drug released at time points using different apparatus				Time for complete release
	30mins	60mins	90mins	180mins	
Basket (whole TB)	0.8±1.93	1.7±1.67	5.4±1.3	18.6±9.98	>12hours
Basket (crushed TB)	4.8±1.91	8.3±2.56	11.3±1.3	27.9±3.22	>12hours

tablet (pieces from 200mg to 300mg variable by weight) according using the JP14 method respectively; moreover, the dissolution rate of sodium alginate was also investigated according to the viscosity change in dissolution medium determined by microviscometry. Table 5.3 shows *in vitro* drug dissolution rate based on the whole tablet and crushed tablet pieces respectively. The overall drug dissolution from whole tablet was slower than from crushed pieces, which can be explained by the greater exposed surface area and therefore faster water uptake rate into the crushed tablet.

However, after 12 hours, the sodium alginate matrix still remained in the basket, which suggested that the basket limits the swelling and erosion processes of the chewable tablet during the rotating basket dissolution. As shown in Figure 5.5, the release profiles of drug from both whole tablets and crushed tablets tested by rotating basket were almost linear at very low and flat levels. Moreover, sodium alginate in the whole tablet dissolved very slowly compared to the dissolution rate from the crushed tablet, which indicated that the tablet dissolution was controlled by the polymer rather than the drug for both whole and crushed tablets(Figure 5.6).

5.3 Results and Discussion

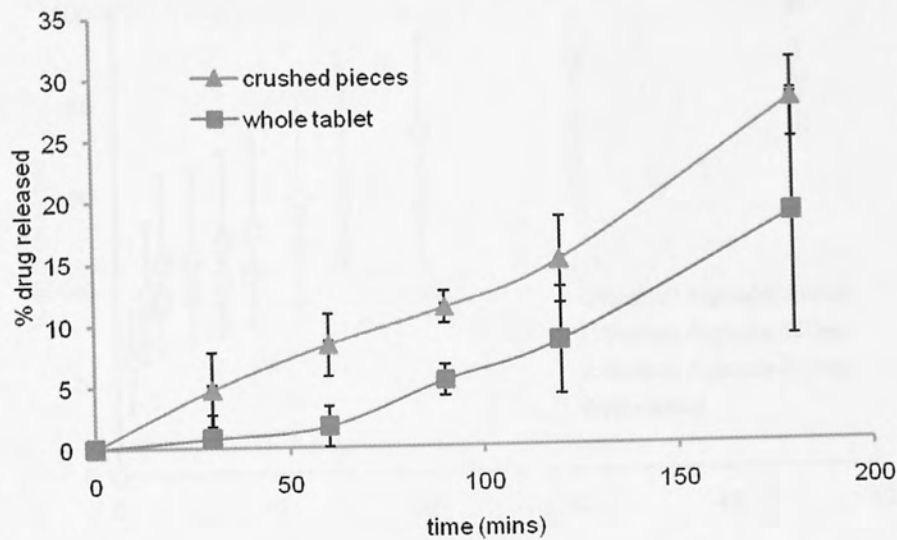

Figure 5.5: Comparison of drug release using basket method: whole tablet (■); crushed tablet (▲) (data shows means \pm S.D., $n=6$)

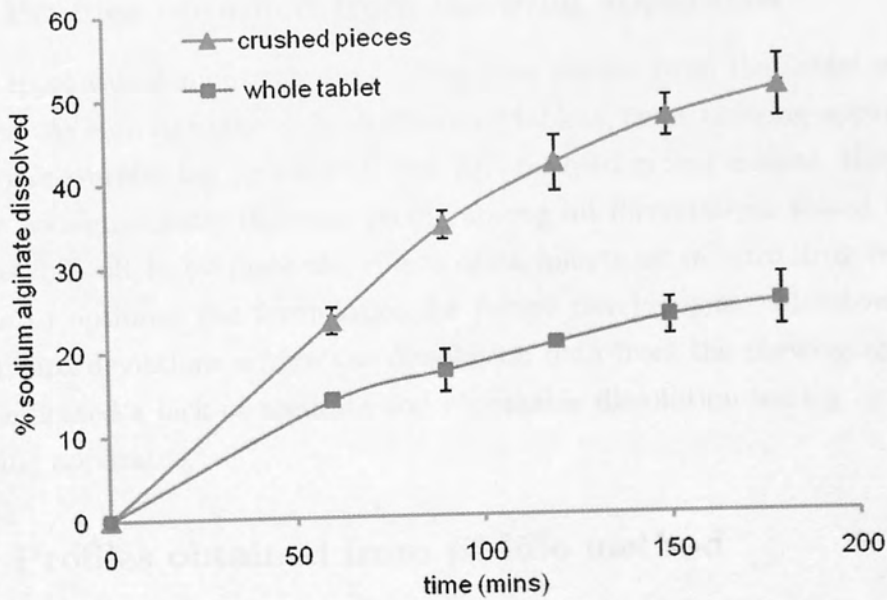

Figure 5.6: Comparison of polymer dissolution using basket method: whole tablet (■); crushed tablet (▲) (data shows means \pm S.D., $n=6$)

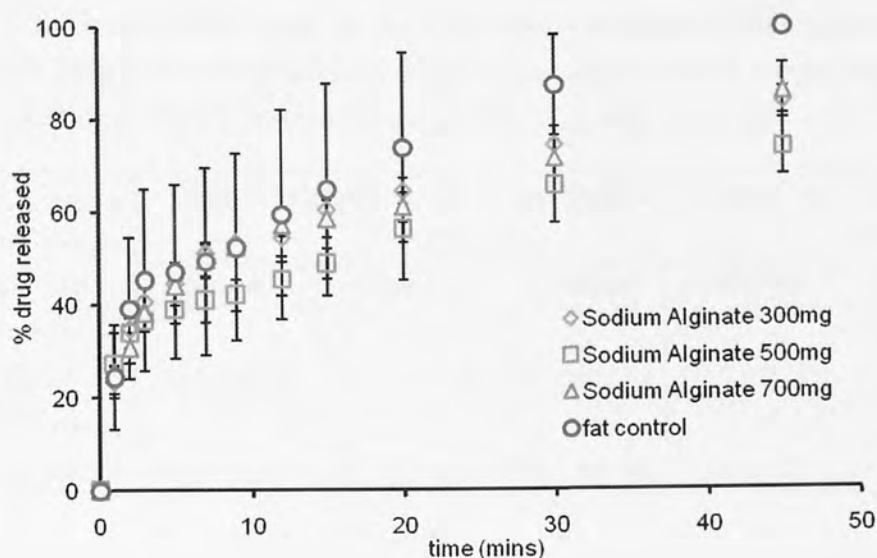

Figure 5.7: The chewable tablets drug release profiles using chewing apparatus (data shows means \pm S.D., $n=6$)

5.3.4 Profiles obtained from chewing apparatus

Chewing apparatus demonstrated complete drug release from the tablet within 30 minutes. As seen in Figure 5.7, all chewable tablets, using chewing apparatus, showed no measurable lag period with over 20% released in first minute. However, there was no significantly different profile among all formulations tested therefore it was difficult to evaluate the effects of excipients on *in vitro* drug release, as well as to optimize the formulation for future development. Moreover, the large standard deviations within the dissolution data from the chewing apparatus also indicated a lack of accurate and repeatable dissolution testing by using the chewing apparatus.

5.3.5 Profiles obtained from paddle method

USP23 paddle apparatus II is the most widely used instrument in dissolution studies (USP28-NF23). However, current researchers have raised numbers of issues with this method including agitation (Sako et al. 2002), rotation speed

5.3 Results and Discussion

Table 5.4: Drug release study of chewable tablet containing 500mg sodium alginate and 500mg Witepsol[®]H15 in whole tablet and crushed pieces respectively, using rotating basket (data shows means \pm S.D., $n=6$)

Dissolution apparatus	%drug released at time points using different apparatus				Time for complete release
	30mins	60mins	90mins	180mins	
Paddle alone	22.6 \pm 3.92	37.6 \pm 14.03	41.1 \pm 5.13	59.7 \pm 3.50	5 hours
Paddle-over-glass beads	33.6 \pm 13.27	73.2 \pm 14.54	88.1 \pm 6.54	100 \pm 8.7	3 hours

(Qureshi 2004), vessel shape (Mirza et al. 2005) and paddle design (Wu et al. 2004); modified paddle method for novel delivery systems such as swellable sticking tablet and swellable floating tablet (Pillay & Fassihi 1999; Karande & Yeole 2006); mass transfer and fluid dynamics modelling of paddle dissolution (McCarthy et al. 2004; Morihara et al. 2002).

Figure 5.8 shows drug release and sodium alginate dissolution profiles from tablets containing 50% sodium alginate using standard paddle method and modified paddle-over-glass beads apparatus respectively. The modified paddle dissolution testing demonstrated a fast stable drug release profile in comparison with the tablets using standard paddle method at all time points as shown in Table 5.4. This is likely to be due to the maintenance of the tablet within a controlled agitation zone. The time for complete drug dissolution was 5 hours using standard paddle method, whereas it was reduced to 3 hours using modified apparatus.

Observations during the test revealed that the chewable tablet in the standard paddle method during was firstly stuck at the bottom of the vessel. As sodium alginate dissolved, the tablet floated on the surface of the dissolution medium. Therefore, suggesting that sticking and floating could be the barriers to drug dissolution when using the standard paddle method.

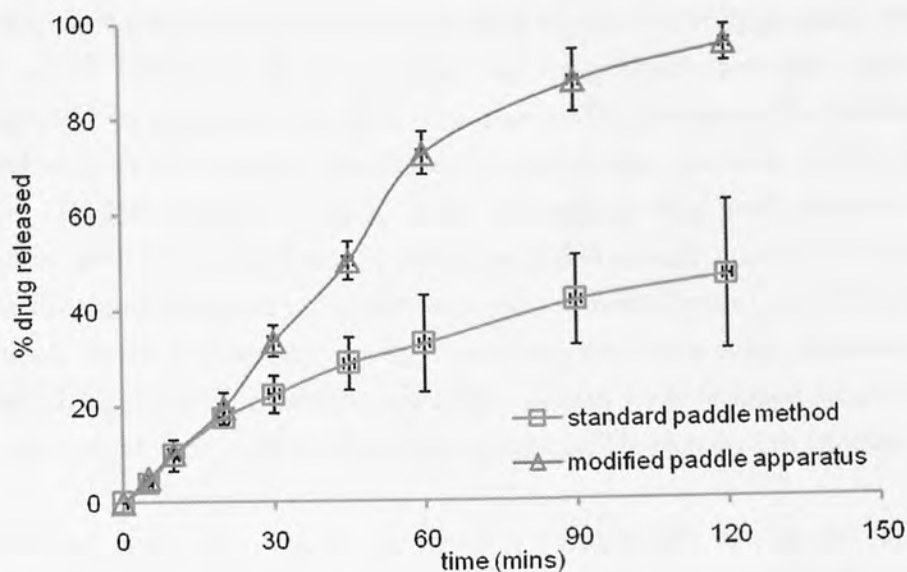

Figure 5.8: Comparison of drug release using paddle alone and paddle-over-glass beads (data shows means \pm S.D., $n=6$)

5.4 Chapter Summary and Conclusions

5.4.1 Appropriate dissolution apparatus for chewable tablet

In general, the dissolution test for chewable tablets should be representative of the *in vivo* dissolution of the dosage form. It should also be able to detect minor changes in tablet composition or manufacturing processes that are relevant to clinical performance. There is also a desire to ensure that standard dissolution apparatus is used for approval from regulatory agencies. Therefore, the USP23 paddle method would be the first choice for dissolution testing. However, in order to simulate 'chewing' actions; more intensive agitation might be applied according to the various approaches.

In this study, the drug and polymer followed the same release profiles that the mechanism was not affected by the dissolution methodology used in all cases. The standard dissolution tests including USP23 apparatus I (rotating basket) and II (paddle method) demonstrated limited use in chewable tablet dissolution. The

5.4 Chapter Summary and Conclusions

rotating basket method restricted the swelling extend of the hydrophilic swellable matrix, which limited both the polymer and drug dissolution rate; although it was improved by crushing the tablet into pieces. Furthermore, the rotating basket method gave the longest dissolution period of the chewable tablet for over 12 hours. Paddle methods provided more dynamic flow of fluid results in a fast dissolution periods within 5 hours. With modified paddle apparatus, the tablet avoided the dead zone and more agitation was provided with the addition of the glass beads in the bottom of vessels. Moreover, the mesh rings between paddle and the tablet ensure the tablet (and tablet pieces) were retained within an agitation controlled zone, which resulted in reproducible dissolution profiles.

The chewing apparatus demonstrated very rapid tablet dissolution within 30 minutes. However, as an appropriate dissolution apparatus, the method should be sensitive to the small change of composition and their dissolution profiles; and the testing should be accurate and repeatable. The excessive 'chewing' from chewing apparatus provided dissolution process too quickly to track the difference with any composition change in this study.

To investigate amount of drug from chewing dosage forms, Pedersen & Rassing (1990) have evaluated the drug release from chewing gum *in vivo*. The study was carried out with four healthy volunteers faster for 2.5 hours. The saliva samples were taken during chewing to evaluate the drug release from chewing gums. Moreover, Maggi et al (2005) also indicated the disadvantages of chewing apparatus described in European Pharmacopoeia and alternatively employed volunteers to chew the dosage forms for a certain period of time. With such an approach, the dosage form can be chewed properly; furthermore, all of the mechanical factors and individual varieties, which will affect the drug release amount and rate, are able to consider during *in vivo* dissolution testing.

Chapter 6

General Conclusions and Future Work

6.1 General Conclusion

6.1.1 The overall assessment of research outcomes

This thesis has focused on the evaluation of the *in vitro* potential of mucoadhesive formulation for the delivery of antifungal agents locally to the oesophageal surface for the treatment of oesophageal candidiasis. A number of mucoadhesive delivery strategies with alternative investigation and optimization approaches has been developed.

- In Chapter 2, a number of bioadhesive liquid formulations investigation have identified the possibility of prolonged formulation retention on the oesophageal surface *in vitro* for the delivery of antifungal agent locally.
 - ✓ The drug diffusion from hydrogel vehicles demonstrated no lag period, which is suitable for *in vivo* therapy.
 - ✓ The effective antifungal drug loading can be achieved for local therapy of oesophageal candidiasis.
 - ✓ The antifungal activity of the formulation can be optimized by improving the solubility of miconazole in the formulation and the use of antifungal bioadhesives (e.g. chitosan).

- In Chapter 3 and 4, hydrophilic matrices including orally dissolving films and tables are developed with the concept to obtain an sufficient drug contained viscous saliva due to the polymer dissolution and maximize the drug contact within the oesophageal surface.
 - ✓ The orally dissolving dosage forms can provide an unit dose of anti-fungal drug.
 - ✓ With specific excipients, the rate of drug release and polymer dissolving of the hydrophilic matrices can be modified; therefore the bioadhesive behaviours of the hydrophilic matrixes can be tailored for the oesophageal targeting.
 - ✓ The drug release mechanism from hydrophilic matrix can not be rely on the mathematical models alone and the measurement of polymer dissolution is necessary.
- In Chapter 5, chewable tablets are investigated as novel dosage form to improve the antifungal drug dissolution and to provide a better oral taste during chewing. To develop novel chewable dosage forms containing an antifungal agent designed to target the oesophagus
 - ✓ A number of dissolution methods employed demonstrate more or less limitation for drug release measurement from chewable tablets.
 - ✓ The drug release rate and amount are affected by the mechanical factors and individual varieties, which need to be considered during the *in vitro* dissolution test.
 - ✓ A desirable dissolution apparatus for chewable dosage forms, more intensive agitation might be applied according to the various approaches to simulate the 'chewing' actions *in vitro*

6.1.2 Potential of bioadhesive liquids for local oesophageal drug delivery

To investigate the potential of local drug delivery targeting the oesophagus, mi-conazole nitrate was used as a model drug in this study and formulated in variety

6.1 General Conclusion

of ways and the *in vitro* release profiles as well as other relevant characterisation tests were performed.

Needleman & Smales (1995) have reported the potential of xanthan gum and chitosan as hydrogel vehicle for buccal drug delivery, therefore in this thesis, the bioadhesive liquids were firstly investigated with these two bioadhesives demonstrating abilities to coat the infected area of the oesophagus and deliver locally acting drugs. In Chapter 2, both xanthan gum and chitosan hydrogels containing anti-fungal agents showed rapid release over 30 minutes and were retained on the oesophageal mucosa up to 30 minutes after washing with saliva saline at 0.5mL/min to mimic the saliva flow. Xanthan gum was retained a far greater extent compared to chitosan. Over 90% of formulation with xanthan was retained after applied on the oesophageal tissue for 30 minutes, compared to chitosan with 30% formulation retained. The results correspond with the adhesive findings by Needleman et al (1997) which indicated that xanthan gum provided the longer retention time on the oral mucosa than chitosan. The good bioadhesive properties of xanthan gum have also been demonstrated in the use of hydrogels (Park & Munday 2004; Sandolo et al. 2007) and buccal tablets (Park & Munday 2004). Park & Munday (2004) studied the buccal tablets prepared with various gums, chitosan and Carbopol to evaluate their characterization of some natural materials for potential use in buccal adhesive dosage forms. In this study, xanthan gum showed the highest hydration capacity with great swelling properties. As the adhesive polymers must be hydrated to facilitate penetration into the mucus, the hydration is an important step in mucoadhesion. Therefore, it is not surprised that xanthan gum tablets with the most hydration capacity present the greatest adhesive behaviors in comparison with the chitosan hydrogel. In addition, the bioadhesive behaviors of xanthan gum have also shown significant strength by the combination with sodium alginate and polycarbophil respectively (Vermani et al. 2002). The study also highlighted the cationic nature of chitosan that allowed the electrostatic interaction with the negatively charged mucous membranes resulting in a prolonged residence time *in vitro*. Both highly hydration capability and cationic charged properties demonstrated that xanthan gum and chitosan are desirable bioadhesives candidates for the oesophageal retention as

well as the drug carriers in mucoadhesive delivery system.

The PEG and glycerol as nonaqueous solvents have been widely used in the mucoadhesives formulations due to abilities to enhanced molecular polymer entanglement, *in vitro* mucoadhesion, drug solubility and moisture uptake (Alsarra et al. 2008; Das & Das 2004; Jones et al. 2008). In bioadhesive hydrogels chapter, the study examined the positive effects of PEG and glycerol in the extent and duration of the formulation adhesion and the controlled release of drug from such systems. However, an increase in the concentration of PEG from 10% to 25% did not significantly increase the drug relelase rate for either formulation thus a level of 10% is sufficient for future formulations development.

The efficacy of the model drug formulated in the bioadhesive drug carriers was measured according to a microdilution method with the minimal inhibitory concentration (MIC) values with the concentration required to be effective against *Candida* is 6.25mg/cm³ of miconazole nitrate. With higher concentrations of PEG and glycerol, the efficacy of the formulation was reduced with some growth with xanthan at a drug concentration of 6.25mg/cm³. Because of anti-fungal activity of chitosan (Knapczyk et al. 1992), the efficacy of the formulation with chitosan was 6.25mg/cm³ at 10% v/v and 25%v/v added excipients. In addition to the desirable bioadhesive properties of chitosan, this cationic polymer also inhibits the adhesion of *C. albicans* cells to the mucosal membranes (Marcinkiewicz et al. 1991). Chitosan has been widely used in bioadhesive formulations for the delivery of antifungal agents such as oral suspensions and gels for the treatment of oral mucositis (Aksungur et al. 2004), buccal disc oral (Yehia et al. 2008) and vaginal fungal infection (Kast et al. 2002).

This preliminary study suggests that a bioadhesive formulation containing antifungal agents may be beneficial in the treatment of Oesophageal Candidiasis. Therefore, alternative mucoadhesive drug delivery system was investigated as dosage form approaches applied orally for the oesophageal targeting.

6.1.3 Evaluation of orally retained dosage forms targeting the oesophagus

In designing orally retained dosage forms based on bioadhesive materials, it is important not only to consider the adhesion but also the ability to provide sustained release of drugs. Moreover, as an alternative formulation for oesophageal delivery, it is highly desirable for the water-soluble polymers to form a concentrated gel-layer that dissociates from the matrix and is retained on the oesophageal surface after swallowing. In chapters 3 and 4, the orally retained formulations including tablets and films, released dissolved drug within the saliva providing an ideal means to target the oesophagus. As a polymeric matrix, it can be either swellable or erodible due to its molecular structure characteristics and hydrophilic behaviors. In oral dissolving films and tablets chapters, the investigation of various factors in the compositions was studied to look insight the drug release mechanism from very hydrophilic matrices and to get an strategic idea for the design of an erodible rather than swellable matrix with most drug release due to the polymer dissolution. The erodible matrix systems have been widely used to achieve a synchronized and sustained drug release (Lu et al. 2007), improve the bioadhesive strength of the formulation (Ali et al. 2002) and control the lag-time prior to the drug release for proposed use (McConville et al. 2005). As an orally retained dissolving dosage form developed to target the oesophagus, drug release was expected to be polymer relaxation controlled more than diffusion alone so that the dissolved drug is present in viscous saliva, which will be benefit for the oesophageal targeting.

6.1.3.1 Hydrophilicity of matrix system

In this thesis, the polymers used in orally retained dosage forms have different hydrophilicity behaviors with an ascending order with MC followed by HPMC; whereas HEC is the most hydrophilic of all three polymers. In the physical mechanical study, swelling behaviors of film matrix was demonstrated on the agar plate in an incubator maintained at 37°C over 60 minutes. Nafee et al (2003) tested the swelling behavior of antifungal patches including HEC films. The study

6.1 General Conclusion

allowed the patches swell on the agar surface and determined the diameter difference of original and swollen patches. Such a swelling measurement has also been applied to the novel mucoadhesive dosage forms including the adhesive tablets for the treatment of vaginal fungal infection (Sharma et al 2006) and buccal tablets for hypertension therapy (Yamsani et al 2007; Patel et al. 2006). The results from these studies indicated that, as a hydrophilic matrix, hydrophilicity and viscosity are the two important factors in its swelling potential. In Chapter 3, the films swelling was evaluated by the percentage of the increased diameter compared to the original film, although the increased thickness could be considered as the three dimensional nature of the hydration process. The film prepared with HEC swelled far more than HPMC and MC films. The descending order of swollen patches by diameter was HEC matrix followed by HPMC then MC matrices. This result correlated to the same order of hydrophilicity of the three celluloses. Moreover, increased polymer content resulted in a greater swelling in MC and HEC films after 60 minutes, whereas a slight limitation in HPMC films swelling occurred when the polymers concentration increased from 6%w/w to 8%w/w. This result suggests that more polymer loading at low concentration provided greater hydration capability, however, the highly polymer content may slow down the rate of water penetration into the hydrophilic matrix. As discussed previously, the hydration of polymer will result in a dehydration of mucous membrane due to the penetration and entanglement. Therefore, the hydrophilic matrix with improved hydration capability is a desirable vehicle for mucoadhesive drug delivery.

In the present of glycerol, the polymer film became strong rather than brittle due to the plastic function. With more glycerol loading from 5%v/v to 10%v/v, all films demonstrated more flexible behaviors with greater elongation. The flexibility of the film is also related to the polymeric chains entanglement. More hydrophilic polymer was expected to produce more flexible patches due to the loose polymer network. HEC films in this study were the most flexible and deformed a great deal before breaking in the tensile study. In compared to the HEC films deformed easily, MC films were the strongest films with greatest thickness once prepared. The elongation of MC films was not extensive although the force needed to break the films was very high. HPMC films demonstrated a strong

but flexible behavior with a tensile stretching distance before a great breaking force. As a novel dosage form applied on the buccal mucosa, the films need to be soft and flexible for patients compliance. In addition, it also needs to be strong enough to adhere to the buccal mucosa for a certain time in order to provide a sustained drug release.

6.1.3.2 Microviscometry as a technique to quantify polymer dissolution

The drug release from a matrix system is controlled by two parameters, the drug carrier and the drug solubility alone. If the drug release exhibits carrier-controlled only, it is polymer relaxational release that is only dependant of the polymer dissolution rate and independent of the drug loaded. On the other side, if the drug release occurs due to the concentration gradient during the water uptake of the matrix, it is drug diffusional release that only affected by the solubility of the drug in the dissolution medium. For the drug release more controlled by the polymeric carrier, it is possible to evaluate the drug release according to the determination of polymer dissolution rate from the matrix (Esnaashari et al 2005). Although many researchers have focused on the drug release mechanism from polymeric matrices and highlighted the drug release controlled by polymeric chains relaxation, few studies are reported to evaluate the drug release from erodible matrix by the polymer dissolution determination.

The polymer dissolution can be measured by various techniques and have been discussed by (Miller-Chou & Koenig, 2003 and Narasimhan 2001). In Chapter 3 and 4, the microviscometer was employed to determine the polymer dissolution rate during the drug release from erodible formulations. The viscosity of hydrophilic polymer solution was linear against the polymer concentration over the concentration range investigated. The amount of polymer dissolution from the tablets was therefore quantified according to the linear calibration curve. With loose networks, as in the very hydrophilic HEC polymer, the slope of calibration from a series dilution is sharp. The same diluted MC solutions presented a gentle gradient change in viscosity, which is due to the strongly entangled chains network in MC matrix.

As the presence of polymer is the only factor affecting the viscosity of the solution, this method was utilized to quantify the polymer dissolution rate. In the films chapter, the polymer dissolution study was focused on the HPMC films at different molecular weight grades. The results showed that all films demonstrated a rapid polymer dissolution rate, which suggested the drug particles were left in the dissolution medium for diffusion following the Fickian kinetics. This suggestion corresponded to the drug release mechanism by fitting the drug release data to the Peppas and Sahlin mathematics modelling, which indicated the mainly Fickian diffusional drug release from HPMC films at different molecular weight. The rapid polymer dissolution was also demonstrated in Chapter 4, when 50% of celluloses were replaced by lactose in HEC and HPMC matrix tablets. According to the significantly reduced drug release, it is believed that the drug particles were left for diffusion in the dissolution medium after rapid disintegration of the polymer matrices. This Fickian diffusional drug release mechanisms were also indicated by mathematics modelling with good fitness.

Although the same results in drug release mechanism were concluded, the methodologies of mathematics modelling and polymer dissolution measurement should be considered respectively. As looked insight into Peppas equations, the definition of Fickian diffusion is the diffusion of drug particle from a swollen matrix which can be affected by the nature of hydrophilic polymer including the hydration capability, polymer chains flexibility and either erodible or swellable nature of the matrix. Such Fickian diffusion dose not simply follow the dissolution process of a solid into liquid. On the other side, the Fickian diffusional controlled release from mathematics modelling predicts a swellable matrix nature which was inconsistent with the rapid polymer dissolution. Therefore, it is suggested that the drug release mechanism from hydrophilic matrix can not be rely on the mathematics models alone and the measurement of polymer dissolution is necessary.

6.1.3.3 Drug release mechanism from matrix system

Many mathematics models have been used to simulate the drug release kinetics from polymer systems. In this study, the Peppas model was used to classify

6.1 General Conclusion

Fickian diffusion and anomalous transport of drug particles during release from matrices. The diffusional coefficient, n , is dependant upon the geometry of the formulation and for a film, an n value of 0.5 indicates Fickian diffusion, $0.5 < n < 1$ indicates anomalous mechanism and $n=1$ indicates case II transport where the dominant mechanism for drug transport is due to polymer relaxation during gel swelling. On the other side, the n value between 0.45 and 0.89 was anomalous transport for tablet dosage forms and an n value of 0.45 indicates that the drug released from the matrix only depends on the drug concentration gradient formed by water uptake of the matrix. In Chapter 3 and 4, the drug release of most hydrophilic matrices was anomalous mechanism which means the drug release was controlled by both liquid diffusion and polymer chains relaxation. As simply fitted to the Peppas model, it is difficult to qualify the amount of drug release controlled by Fickian diffusion or by polymer relaxation which is necessarily considered in formulations development for the oesophageal retention. Therefore, the second generation equation described by Peppas & Sahlin in 1989 was employed to understand the contribution of both Fickian diffusion and relaxation in anomalous transport. The drug release data from hydrophilic matrix system showed well goodness of fit of both mathematic modeling techniques with variance over than 0.9 to describe the drug release mechanism.

In films chapter, the effects of polymer loading, molecular weight and additional plasticizer were studied to evaluate the ideal formulation with more polymer relaxational drug release for the oesophageal delivery. It was demonstrated that in all films, greater polymer content improved the polymer relaxation contribution in drug release mechanism. When the polymer content was at high level, the polymer chain relaxation lead the drug release rate rather than diffusional release, as the polymer chains were more flexible. In addition, more glycerol in the films provided positive effect on polymer relaxational drug release. Although both polymer content and glycerol loading limited the overall drug release due to the less flexibility of polymer chains with longer hydration process, it is expected that such films may provide a sustained drug release within enhanced viscous saliva for a prolonged retention time on the oesophageal surface. On the other side, the tablets prepared with highly hydrophilic polymer (HEC)

showed erodible nature with the most polymer relaxational controlled drug release followed by HPMC tablets in comparison with the swelling-controlled MC tablets in Chapter 4. According to the mathematics modelling results, lactose as diluents in MC tablet increased the amount of drug release controlled by polymer chains relaxation, whereas enhanced Fickian diffusion occurred in HEC and HPMC tablets due to the further water penetration into the very hydrophilic matrices. With rapid polymer dissolution from low content HEC and HPMC matrices, the polymer chains relaxation showed very limited action in drug release control. Therefore, the present of lactose was expected to make the swellable matrix more erodible, which is desirable in oral dissolving formulations development, however, for the erodible tablet, additional lactose may result in a very loose matrix with rapid disintegration after applied into the dissolution medium. Moreover, the drug release demonstrated a trend to be controlled by polymeric chains relaxation with decreasing diffusional release fractions in all hydrophilic matrix systems.

All in all, as an oral dissolving dosage form developed targeting the oesophagus, the drug release is expected to be polymer relaxation control more than diffusion alone from the dosage forms so that the dissolved drug is present in viscous saliva due to the polymer dissolving, which will be benefit for the oesophageal targeting.

6.2 Future Work

6.2.1 Formulations approaches to oesophageal drug delivery

In previous study, when a hydrogel formulation target to the oesophagus was developed for oral administration containing miconazole nitrate as antifungal agent, there were two serious issues during the study: the solubility of miconazole in the vehicle and *in vitro* retention time of the formulation on surface of the mucous membrane. The formulation approaches in next strategy is to improve the solubility and permeability of the drug in the applied dosage form, and to prolong the *in vitro* retention time of the formulation on the surface of the oesophageal tissue.

Miconazole as a topically antifungal agent has a poor availability when it was applied by oral administration. This is due to its extremely low solubility in both oil and water that results in a low dissolution rate in mucosal fluid, however, the drug with original particle size is not easy to be captured and translocated by the mucous gel layer resulting in a low mucosal permeability.

Recently, studies (Fujii et al. 2002) have been reported to improve the solubility of miconazole by supersaturation of miconazole in a vehicle. This technique can be explained by the interaction between a drug and phospholipids when some of drug dissolved in the medium at a high temperature, and can remain as a solution at room temperature.

Ponchel et al (1997) has indicated the *in vitro* potential of particle adsorption on the intestinal mucosa. When the micro-sized drug particles (2-3 μm) were studied, the *in vitro* absorption was affected by the charge of the particles. Negative-charged particles were difficult to transfer because of the also negative charged mucus due to an energy barrier to overcome. On the contrary, when the zeta potential of the particles was positive or close to zero ($\sim 10\text{mV}$), the fraction adsorbed of positive-charged particles was higher, however, this adsorption decreased when the electronic charge increased. On the other hand, particle size was another considerable effect for the intestinal adsorption of the mucous gel layer. Figure has showed the different mechanisms of absorption when two cases of particle size applied. It was apparently indicated that the drug particles at small size ($< 1\ \mu\text{m}$) in the hydrogen vehicle can be transferred deep distance into mucous gel layer by diffusion until saturation. For the larger particles (i.e. $> 1\ \mu\text{m}$), the mucosal surface on the intestinal wall could be considered as a smooth surface, because there were not big enough excess for the particles to go through the mucosa gel layer.

On the other hand, as a colloidal vehicle prepared by viscous polymer for the oesophageal delivery, the duration time of the formulation on the mucosal surface was related to the particle size of polymers reported by Richardson et al

(2005). Some studies also indicated that non-drug-loaded polymeric nanoparticles have a potential to treat *C. albicans* directly by disrupting the microbial adherence process to a cellular substance (McCarron et al. 2004). Therefore, the solubility of miconazole and the particle size of both drug and polymeric compounds are to be considered.

In the following study, the incorporation of the viscous vehicle and micronized polymer-drug mixture system solid particles of drug encapsulated within a polymer into a liquid vehicle will be focused on. This will form a suspension of drug-polymer particles within a viscous liquid, which are associated with multi-fold advantages, including the presentation of very small drug particles to the mucosal surface to optimize their absorption.

A solid dispersion is an intimate mix of drug with a polymer to form a "solid-solution". This means that the drug is effectively solubilised within the polymer and it is generally believed that as the polymer dissolves this promotes concomitant dissolution of the drug to maximise its absorption. The physical form also increases the surface area of the drug particles by allowing a formulation of micronised drug to provide improved wetting and thus dissolution. Thermal analysis is used to determine the mixing of a drug and polymer as the absence of any detectable crystalline drug in a mixed system is indicative of a solid solution. Crystalline materials show a distinctive melting endotherm at their melting temperature, this event can be measured using differential scanning calorimetry (DSC); when the drug is mixed with the polymer and spray-dried, if a melting endotherm for the drug is no longer visible then this suggests that a solid solution is formed. One limitation of DSC is that the melting endotherm observed is measured close to the melting temperature of the drug which can be much higher than the relevant usage/storage temperature leading to inaccurate results (for miconazole the melting temperature is 159-163°C). Hyper DSC is an advanced DSC technique that allows very fast heating rates to be applied to samples which means that further kinetic events, such as additional mixing of drug and polymer as the temperature increases, which can occur in conventional DSC, are minimised allowing a more accurate measurement. Solid dispersions can be prepared

6.2 Future Work

using a variety of manufacturing techniques. Spray-drying is the most commonly used technique to prepare small particles of drug-in-polymer dispersions.

It has been proposed that these dehydrated polymer particles are formulated within a liquid vehicle, once swallowed some of these particles adhere to the oesophageal mucosa where they are retained due to water transfer from the tissue into the dehydrated particle. Upon this mass transfer the particle will hydrate and allow release and absorption of the drug at the site of action. Finally, to optimize the research outcomes of *in vitro* study, one of the most important work in the further is to actively seek to develop collaborations with clinical centers where the most promising formulations developed using the *in vitro* methods can be trialled and visualized *in vivo*.

Chapter 7

Bibliography

Aceves, S. S., Dohil, R., Newbury, R. O., & Bastian, J. F. 2005, "Topical viscous budesonide suspension for treatment of eosinophilic esophagitis", *J Allergy Clin Immunol*, vol. 116, no. 3, pp. 705-706.

Accili, D., Menghi, G., Bonacucina, G., Martino, P. D., & Palmieri, G. F. 2004, "Mucoadhesion dependence of pharmaceutical polymers on mucosa characteristics", *Eur J Pharm Sci*, vol. 22, pp. 225-234

Addy, M. & Roberts, W. R. 1981, "Comparison of the bisbiguanide antiseptics alexidine and chlorhexidine. II. Clinical and *in vitro* staining properties", *J Clin Periodontol*, vol. 8, no. 3, pp. 220-230.

Adler, D. & Romero, Y. 2001, "Primary esophageal motility disorders", *Mayo Clin Proc*, vol. 76, no. 2, pp. 195-200.

Aiache, J. M., Costantini, D., & Chaumont, C. 2005, Prolonged release bioadhesive therapeutic systems (patent).

Aksungur, P., Sungur, A., Unal, S., Iskit, A. B., Squier, C. A., & Senel, S. 2004, "Chitosan delivery systems for the treatment of oral mucositis: *in vitro* and *in vivo* studies", *J Control Release*, vol. 98, no. 2, pp. 269-279.

Ali, J., Khar, R., Ahuja, A., & Kalra, R. 2002, "Buccoadhesive erodible disk for treatment of oro-dental infections: design and characterisation", *Int J Pharm*, vol. 238, no. 1-2, pp. 93-103.

Allen, C., Maysinger, D., & Eisenberg, A. 1999, "Nano-engineering block copolymer aggregates for drug delivery", *Colloids Surf., B*, vol. 16, no. 1-4, pp. 3-27.

Alsarra, I. A., Hamed, A. Y., Mahrous, G. M., El Maghraby, G. M., Al-Robayan, A. A., & Alanazi, F. K. 2008, "Mucoadhesive polymeric hydrogels for nasal delivery of acyclovir", *Drug Dev Ind Pharm*, pp. 1-11.

Andersen, T., Gram-Hansen, M., Pedersen, M., & Rassing, M. R. 1990, "Chewing gum as a drug delivery system for nystatin. Influence of solubilising agents on the release of water-soluble drugs", *Drug Dev.Ind.Pharm.*, vol. 16, pp. 1985-1994.

Andreopoulos, A. G. & Tarantili, P. A. 2001, "Xanthan gum as a carrier for controlled release of drugs", *J Biomater Appl*, vol. 16, no. 1, pp. 34-46.

Ativanichayaphong, T., Huang, W. D., Wang, J., Rao, S., Tibbals, H., Tang, S. J., Spechler, S. J., Stephanou, H., & Chiao, J. C. 2007, "An Implantable Wireless Impedance Sensor Capable of Distinguishing Air, Water and Acid in Gastroesophageal Reflux", *Gastrointestinal Endoscopy*, vol. 65, no. 5, p. AB332.

Attwood, S. E. A. 1994, "What factors are evidenced by study of the mucins of the oesophageal glands during oesophagitis?," in *The Esophageal Mucosa - 300 Questions 300 Answers*, R. Guili et al., eds., Elsevier, pp. 300-302.

Barembaum, S., Virga, C., Bojanich, A., Cornejo, L., Calamari, S., Ponton, J., & Dorransoro, S. 2003, "Effect of Chitosan and Sodium Alginate on the adherence of autochthonous *C. Albicans* to oral epithelial cells (*in vitro*)", *Med.Oral*, vol. 8, no. 3, pp. 188-196.

Barillaro, V., Bertholet, P., Henry de, H. S., Ziemon, E., Evrard, B., Delattre, L., & Piel, G. 2004, "Effect of acidic ternary compounds on the formation of miconazole/cyclodextrin inclusion complexes by means of supercritical carbon dioxide", *J Pharm Pharm Sci*, vol. 7, no. 3, pp. 378-388.

Barillaro, V., Dive, G., Bertholet, P., Evrard, B., Delattre, L., Eric, Z., & Piel, G. 2007, "Theoretical and experimental investigations on miconazole/cyclodextrin/acid complexes: molecular modeling studies", *Int J Pharm*, vol. 342, no. 1-2, pp. 152-160.

Barreca, J. 2005, Chewing gum containing calcium, 6869614 (patent).

Bastian, H. L., Rindum, J., & Lindeberg, H. 2004, "A double-dummy, double-blind, placebo-controlled phase III study comparing the efficacy and efficiency of miconazole chewing gum with a known drug (Brentan(R) gel) and a placebo in patients with oral candidosis", *Oral Surgery, Oral Medicine, Oral Pathology, Oral Radiology, and Endodontology*, vol. 98, no. 4, pp. 423-428.

Batchelor, H. 2005, "Bioadhesive dosage forms for esophageal drug delivery", *Pharm Res*, vol. 22, pp. 175-181. Ref Type: Abstract

Batchelor, H. K., Banning, D., Dettmar, P. W., Hampson, F. C., Jolliffe, I. G., & Craig, D. Q. M. 2002, "An *in vitro* mucosal model for prediction of the bioadhesion of alginate solutions to the oesophagus.", *Inter J Pharm*, vol. 238, pp. 123-132. Ref Type: Abstract

Batchelor, H. K., Tang, M., Dettmar, P. W., Hampson, F. C., Jolliffe, I. G., & Craig, D. Q. M. 2004, "Feasibility of a bioadhesive drug delivery system targeted to oesophageal tissue", *European Journal of Pharmaceutics and Biopharmaceutics*, vol. 57, no. 2, pp. 295-298.

Becker, A., Katzen, F., Puhler, A., & Ielpi, L. 1998, "Xanthan gum biosynthesis and application: a biochemical/genetic perspective", *Appl Microbiol Biotechnol*,

vol. 50, no. 2, pp. 145-152.

Blaschek, W. 1990, "Cellulose, an interesting excipient for pharmaceutical use", *Pharm Unserer Zeit*, vol. 19, no. 2, pp. 73-81

Blot, W., Devesa, S., Kneller, R., & Fraumeni, J. J. 1991, "Rising incidence of adenocarcinoma of the esophagus and gastric cardia.", *JAMA*, vol. 265, no. 22, pp. 1287-1289.

Bogaardt, H. C. A., Burger, J. J., Fokkens, W. J., & Bennink, R. J. 2007, "Viscosity Is Not a Parameter of Postdeglutitive Pharyngeal Residue: Quantification and Analysis with Scintigraphy", *Dysphagia*, vol. 22, no. 2, pp. 145-149.

Bonacini, M. 2001, "Medical management of benign oesophageal disease in patients with human immunodeficiency virus infection", *Dig Liver Dis*, vol. 33, no. 3, pp. 294-300.

Bonatti, H., Hinder, R. A., Klocker, J., Neuhauser, B., Klaus, A., Achem, S. R., & de Vault, K. 2005, "Long-term results of laparoscopic Heller myotomy with partial fundoplication for the treatment of achalasia", *Am J Surg*, vol. 190, no. 6, pp. 883-887.

Bonferoni, M. C., Chetoni, P., Giunchedi, P., Rossi, S., Ferrari, F., Burgalassi, S., & Caramella, C. 2004, "Carrageenan-gelatin mucoadhesive systems for ion-exchange based ophthalmic delivery: *in vitro* and preliminary *in vivo* studies", *Eur J Pharm Biopharm*, vol. 57, no. 3, pp. 465-472.

Borgquist, P., Korner, A., Piculell, L., Larsson, A., & Axelsson, A. 2006, "A model for the drug release from a polymer matrix tablet-effects of swelling and dissolution", *J Control Release*, vol. 113, no. 3, pp. 216-225.

Bortolotti, M. 2006, "A novel antireflux device based on magnets", *J Biomech*, vol. 39, no. 3, pp. 564-567.

Bouchier, A., Hodgson, K., & Baillere, T. 2005, "The Oesophagus," in Textbook of Gastroenterology, A. Bouchier, K. Hodgson, & T. Baillere, eds., WB Saunders, Philadelphia.

Bouckaert, S. & Remon, J. P. 1993, "In-vitro bioadhesion of a buccal, miconazole slow-release tablet", *J Pharm Pharmacol*, vol. 45, no. 6, pp. 504-507.

Bouckaert, S., Schautteet, H., Lefebvre, R. A., Remon, J. P., & van, C. R. 1992, "Comparison of salivary miconazole concentrations after administration of a bioadhesive slow-release buccal tablet and an oral gel", *Eur J Clin Pharmacol*, vol. 43, no. 2, pp. 137-140.

Boyce, H. W., Jr. 1999, "Palliation of Dysphagia of Esophageal Cancer by Endoscopic Lumen Restoration Techniques", *Cancer Control*, vol. 6, no. 1, pp. 73-83.

Bures, P., Huang, Y., Oral, E., & Peppas, N. A. 2001, "Surface modifications and molecular imprinting of polymers in medical and pharmaceutical applications", *J. Control Release*, vol. 72, no. 1-3, pp. 25-33.

Caldas, C. 2000, "The genetics of oesophageal carcinogenesis", *J R Coll Surg Edinb*, vol. 45, pp. 259-276.

Cameron, A. 1997, "Epidemiology of columnar-lined esophagus and adenocarcinoma", *Gastroenterol Clin North Am*, vol. 26, no. 3, pp. 487-498.

Cancer Research Campaign, 1998, CRC factsheet 1.1. Ref Type: Pamphlet

Cardot, J. M., Chaumont, C., Dubray, C., Costantini, D., & Aiache, J. M. 2004, "Comparison of the pharmacokinetics of miconazole after administration via a bioadhesive slow release tablet and an oral gel to healthy male and female subjects", *Br J Clin Pharmacol*, vol. 58, no. 4, pp. 345-351.

Carlo, C. G., Bergamante, V., Calabrese, V., Biserni, S., Ronchi, C., & Fini, A. 2006, "Design and evaluation *in vitro* of controlled release mucoadhesive tablets containing chlorhexidine", *Drug Dev Ind Pharm*, vol. 32, no. 1, pp. 53-61.

Castell, J. 1995, "Esophageal manometry," in *The Esophagus*, 2nd edn, D. Castell, ed., Little, Brown, Boston, pp. 133-152.

Chiou, C. C., Groll, A. H., & Walsh, T. J. 2000, "New Drugs and Novel Targets for Treatment of Invasive Fungal Infections in Patients with Cancer", *Oncologist*, vol. 5, no. 2, pp. 120-135.

Christrup, L. L., Davis, S. S., Frier, M., Melia, C. D., Rasmussen, S. N., Washington, N., Wilding, I. R., & Andersen, C. 1990, "Deposition of a model substance, ^{99m}Tc E-HIDA, in the oral cavity after administration of lozenges, chewing gum and sublingual tablets", *Int J Pharm*, vol. 66, no. 1-3, pp. 169-174.

Chae, S. Y., Jang, M. K., & Nah, J. W. 2005, "Influence of molecular weight on oral absorption of water soluble chitosans", *J Control Release*, vol. 102, no. 2, pp. 383-394.

Cilurzo, F., Selmin, F., Minghetti, P., Rimoldi, I., Demartin, F., & Montanari, L. 2005, "Fast-dissolving mucoadhesive microparticulate delivery system containing piroxicam", *Eur J Pharm Sci*, vol. 24, no. 4, pp. 355-361.

Clarke, J. O., Jagannath, S. B., Kalloo, A. N., Long, V. R., Beitler, D. M., & Kantsevov, S. V. 2007, "An endoscopically implantable device stimulates the lower esophageal sphincter on demand by remote control: a study using a canine model.", *Endoscopy*, vol. 39, pp. 72-76. Ref Type: Abstract

Clouse, R. & Hallett, J. 1992, "What degree of impaired peristalsis is important for the diagnosis of diffuse esophageal spasm?", *Am J Gastroenterol*, vol. 87, p. 1246A.

Codd, J. E. & Deasy, P. B. 1998, "Formulation development and *in vivo* evaluation of a novel bioadhesive lozenge containing a synergistic combination of antifungal agents", *Int J Pharm*, vol. 173, no. 1-2, pp. 13-24.

Collaud, S., Warloe, T., Jordan, O., Gurny, R., & Lange, N. 2007, "Clinical evaluation of bioadhesive hydrogels for topical delivery of hexylaminolevulinate to Barrett's esophagus", *J Controlled Release*, vol. 123, no. 3, pp. 203-210.

Collings, K. L., Rodriguez-Stanley, S., Proskin, H. M., Robinson, M., & Miner, P. B. 2002, "Clinical effectiveness of a new antacid chewing gum on heartburn and oesophageal pH control", *Aliment Pharmacol Ther*, vol. 16, pp. 2029-2035.
Ref Type: Abstract

Colombo, P., Bettini, R., Massimo, G., Catellani, P. L., Santi, P., & Peppas, N. A. 1995, "Drug diffusion front movement is important in drug release control from swellable matrix tablets", *J Pharm Sci*, vol. 84, no. 8, pp. 991-997.

Conway, B., R., & batchelor, H., k. 2007, "Targeting infections within the gastrointestinal tract", in Williams, R., O., Taft, D., R., & McConville, J., T. (Ed) 2007, *Advanced drug formulation design to optimize therapeutic outcomes*, CRC press, New York, pp. 217-244

Cuca, R. C., Lienhop, K. S., Riley, T. C., Levinson, R. S., & Kirschner, M. I. 1996, Bioadhesive pharmaceutical delivery system (patent).

De Vries-Hospers, H. G. & Van der, W. D. 1978, "Amphotericin B concentrations in saliva after application of 2% amphotericin B in orabase", *Infection*, vol. 6, no. 1, pp. 16-20.

Das, N. G. % Das, S. K. 2004, "Development of mucoadhesive dosage forms of buprenorphine for sublingual drug delivery", *Drug Deliv*, vol. 11, no. 2, pp. 89-95.

Dash, A. K. & Cudworth, G. C. 2001, "Evaluation of an acetic acid ester of monoglyceride as a suppository base with unique properties", *AAPS Pharm Sci Tech*, vol. 2, no. 3, p. E13.

Dean, B. B., Crawley, J. A., Schmitt, C. M., Wong, J., & Ofman, J. J. 2003, "The burden of illness of gastro-oesophageal reflux disease: impact on work productivity", *Alimentary Pharmacology & Therapeutics*, vol. 17, no. 10, pp. 1309-1317.

Dhiman, M. K., Yedurkar, P. D., & Sawant, K. K. 2008, "Buccal bioadhesive delivery system of 5-fluorouracil: optimization and characterization", *Drug Dev Ind Pharm*, vol. 34, no. 7, pp. 761-770.

Dobrozsi, D. J. 2003, Oral liquid mucoadhesive compositions (patent).

Dobrozsi, D. J., Smith, R. L., & Sakr, A. A. 1999, "Comparative mucoreten-
tion of sucralfate suspensions in an everted rat esophagus model", *Int J Pharm*,
vol. 189, no. 1, pp. 81-89.

Dohil, R., Bastian, J., & Aceves, S. S. 2007, Viscous budesonide for the treatment
of inflammatory diseases of the gastrointestinal tract (patent).

Duchene, D. & Ponchel, G. 1992, "Principle and investigation of the bioadhe-
sion mechanism of solid dosage forms", *Biomaterials*, vol. 13, no. 10, pp. 709-714.

Edwards, D. A. W. 1984, "Physiology. The Oesophagus.," in *Textbook of Gas-
troenterology*, I. A. D. Bouchier et al., eds., Balliere Tindall, W B Saunders,
Philadelphia, pp. 18-26.

El-Gazayerly, O. N., Rakkanka, V., & Ayres, J. W. 2004, "Novel chewable sustained-
release tablet containing verapamil hydrochloride", *Pharm Dev Technol*, vol. 9,
no. 2, pp. 181-188.

Emslie, R. D. 1967, "Treatment of acute ulcerative gingivitis. A clinical trial

using chewing gums containing metronidazole or penicillin.”, *Br Dental J*, vol. 122, pp. 307-308.

Esnaashari, S., Javadzadeh, Y., Batchelor, H. K., & Conway, B. R. 2005, “The use of microviscometry to study polymer dissolution from solid dispersion drug delivery systems”, *Int J Pharm*, vol. 292, pp. 229-230.

European Directorate for the Quality of Medicines, Council of Europe. European Pharmacopoeia. Suppl. 5.2. General Monograph 2.9.25: Dissolution Test for Medicated Chewing Gums. 5th Ed. Strasbourg, France; 2005, pp.3116C3117

Fan, Y., Gregersen, H., & Kassab, G. S. 2004, “A two-layered mechanical model of the rat esophagus. Experiment and theory”, *BioMedical Engineering OnLine*, vol. 3, no. 1, p. 40.

Ferlay, J. 1992, “Cancer Incidence in Five Continents. Processing of data”, *IARC Sci Publ*, no. 120, pp. 39-44.

Fujii, M., Buyuktimkin, S., Buyuktimkin, N., & Rytting, J.H. 2002, “Enhancement of skin permeation of miconazole by phospholipids and dodecyl 2-(N,N-dimethyl amino) propionate (DDAIP)”, *Int J Pharm*, vol. 234, pp. 121-128

Gavini, E., Sanna, V., Juliano, C., Bonferoni, M. C., & Giunchedi, P. 2002, “Mucoadhesive vaginal tablets as veterinary delivery system for the controlled release of an antimicrobial drug, acriflavine”, *AAPS Pharm Sci Tech*, vol. 3, no. 3, p. E20.

Gaynor, H. M. 1971, “A double blind study of Lidocaine in Orabase”, *J.Conn.State Dent.Assoc.*, vol. 45, no. 2, pp. 75-81.

Gilja, O., Thune, N., Matre, K., Hausken, T., Odegaard, S., & Berstad, A. 1994, “*In vitro* evaluation of three-dimensional ultrasonography in volume estimation of abdominal organs.”, *Ultrasound Med Biol*, vol. 20, no. 2, pp. 157-165.

Giunchedi, P., Juliano, C., Gavini, E., Cossu, M., & Sorrenti, M. 2002, "Formulation and *in vivo* evaluation of chlorhexidine buccal tablets prepared using drug-loaded chitosan microspheres", *Eur J Pharm Biopharm*, vol. 53, no. 2, pp. 233-239.

Gmunder, C. B., Li, W., & Ream, R. L. 2003, Sildenafil citrate chewing gum formulations and methods of using the same (patent).

Gorman, S. P., McCafferty, D. F., Woolfson, A. D., & Jones, D. S. 1987, "A comparative study of the microbial antiadherence capacities of three antimicrobial agents", *J Clin Pharm Ther*, vol. 12, no. 6, pp. 393-399.

Gravett, D. M., Takacs-Cox, A., Toleikis, P. M., Maiti, A., & Embree, L. 2004, "Drug delivery from rapid gelling polymer composition", (patent).

Gregersen, H., Gravesen, F., & Lontis, R. 2006, "Apparatus and method for a global model of hollow internal organs including the determination of cross-sectional areas and volume in internal hollow organs and wall properties", (patent).

Gurny, R., Meyer, J. M., & Peppas, N. A. 1984, "Bioadhesive intraoral release systems: design, testing and analysis", *Biomaterials*, vol. 5, no. 6, pp. 336-340.

Habib, W., Khankari, R., & Hontz, J. 2000, "Fast-dissolve drug delivery systems", *Crit Rev Ther Drug Carrier Syst*, vol. 17, no. 1, pp. 61-72.

Haringsma, J. 2002, "Barrett's Oesophagus: New Diagnostic and Therapeutic Techniques", *Scand J Gastroenterol*, vol. 37, no. S236, pp. 9-14.

Hench, L. L. 1998, "Biomaterials: a forecast for the future", *Biomaterials*, vol. 19, no. 16, pp. 1419-1423.

Henriksen, I., Green, K. L., Smart, J. D., Smistad, G., & Karlsen, J. 1996, "Bioadhesion of hydrated chitosans: An *in vitro* and *in vivo* study", *Int J Pharm*, vol. 145, no. 1-2, pp. 231-240.

Hirano, S., Tsuchida, H., & Nagao, N. 1989, "N-acetylation in chitosan and the rate of its enzymic hydrolysis", *Biomaterials*, vol. 10, no. 8, pp. 574-576.

Hill, I. D., Walters, P. P., & Brown, D. G. 1998, Ultramulsion based ingestible compositions (patent). Hirano, S., Tsuchida, H., & Nagao, N. 1989, "N-acetylation in chitosan and the rate of its enzymic hydrolysis", *Biomaterials*, vol. 10, no. 8, pp. 574-576.

Hostetler, J. S., Hanson, L. H., & Stevens, D. A. 1992, "Effect of cyclodextrin on the pharmacology of antifungal oral azoles", *Antimicrob Agents Chemother*, vol. 36, no. 2, pp. 477-480.

Honkanen, O., Laaksonen, P., Marvola, J., Eerikainen, S., Raimo, T., & Marvola, M. 2002, "Bioavailability and *in vitro* oesophageal sticking tendency of hydroxypropyl methylcellulose capsule formulations and corresponding gelatine capsule formulations", *Eur J Pharm Sci*, vol. 15, no. 5, pp. 479-488.

Huang, Y., Leobandung, W., Foss, A., & Peppas, N. A. 2000, "Molecular aspects of muco- and bioadhesion: tethered structures and site-specific surfaces", *J Control Release*, vol. 65, no. 1-2, pp. 63-71.

Huang, Y. B., Tsai, Y. H., Yang, W. C., Chang, J. S., & Wu, P. C. 2003, "Influence of formulatin variables and manufacturing process on propranolol extended release profile from HPMC matrices tablets", *J Appl Polym Sci*, vol. 93, pp.1886-1890

Hunerbein, M., Gretschel, S., Ghadimi, B. M., & Schlag, P. M. 1997, "Three-dimensional endoscopic ultrasound of the esophagus. Preliminary experience." *Surg Endosc*, vol. 11, pp. 991-994.

Ikinci, G., Senel, S., Akincibay, H., Kas, S., Ercis, S., Wilson, C. G., & Hincal, A. A. 2002, "Effect of chitosan on a periodontal pathogen *Porphyromonas gingivalis*", *Int J Pharm*, vol. 235, pp. 121-7.

Ikinci, G., Senel, S., Wilson, C. G., & Sumnu, M. 2004, "Development of a buccal bioadhesive nicotine tablet formulation for smoking cessation", *Int J Pharm*, vol. 277, no. 1-2, pp. 173-178.

Ippoliti, A. 1983, "Esophageal disorders in diabetes mellitus", *Yale J Biol Med*, vol. 56, no. 4, pp. 267-270.

Ishibashi, H., Uchida, K., Nishiyama, Y., Yamaguchi, H., & Abe, S. 2007, "Oral administration of itraconazole solution has superior efficacy in experimental oral and oesophageal candidiasis in mice than its intragastric administration." *J Antimicrob Chemother*, vol. 59, pp. 317-320.

Ito, R., Machida, Y., Sannan, T., & Nagai, T. 1990, "Magnetic granules: a novel system for specific drug delivery to esophageal mucosa in oral administration", *Int J Pharm*, vol. 61, no. 1-2, pp. 109-117.

Jackson, S. J., Bush, D., & Perkins, A. C. 2001, "Comparative scintigraphic assessment of the intragastric distribution and residence of cholestyramine, Carbopol 934P and sucralfate", *Int J Pharm*, vol. 212, no. 1, pp. 55-62.

Jankowska, M., Lemańska, M., Trocha, H., Gesing, M., & Smiatacz, T. 2001, "Opportunistic infections in HIV-positive patients hospitalized in the Clinic of Infectious Diseases AMG", *Przegląd epidemiologiczny*, vol. 55, pp. 125-128.

Johannessen, T. & Kristensen, P. 1997, "On-demand therapy in gastroesophageal reflux disease: a comparison of the early effects of single doses of fast-dissolving famotidine wafers and ranitidine tablets", *Clin Ther*, vol. 19, pp. 73-81.

Jones, D. S., Muldoon, B. C., Woolfson, A. D., Andrews, G. P., & Sanderson, F. D. 2008, "Physicochemical characterization of bioactive polyacrylic acid organogels as potential antimicrobial implants for the buccal cavity", *Biomacromolecules.*, vol. 9, no. 2, pp. 624-633.

Junyaprasert, V. B. & Manwiwattanakul, G. 2008, "Release profile comparison and stability of diltiazem-resin microcapsules in sustained release suspensions", *Int J Pharm*, vol. 352, no. 1-2, pp. 81-91.

Kahrilas, P. J. 2000, "Esophageal motility disorders: current concepts of pathogenesis and treatment" *Can J Gastroenterol*, vol. 14, pp. 221-231. Ref Type: Abstract

Kanjickal, D. G. & Lopina, S. T. 2004, "Modeling of drug release from polymeric delivery systems—a review", *Crit Rev Ther Drug Carrier Syst*, vol. 21, no. 5, pp. 345-386.

Karande, A. D. & Yeole, P. G. 2006, "Comparative assessment of different dissolution apparatus for floating drug delivery systems", *Dissolution Technol*, vol. 02, pp. 20C23.

Kast, C. E., Valenta, C., Leopold, M., & Bernkop-Schnurch, A. 2002, "Design and in vitro evaluation of a novel bioadhesive vaginal drug delivery system for clotrimazole", *J Control Release*, vol. 81, no. 3, pp. 347-354.

Khanna, R., Agarwal, S. P., & Ahuja, A. 1996, "Preparation and evaluation of bioerodible buccal tablets containing clotrimazole", *Int J Pharm*, vol. 138, no. 1, pp. 67-73.

Kim, T. H., Ahn, J. S., Choi, H. K., Choi, Y. J., & Cho, C. S. 2007, "A novel mucoadhesive polymer film composed of carbopol, poloxamer and hydroxypropylmethylcellulose", *Arch Pharm Res*, vol. 30, no. 3, pp. 381-386.

Kim, J. H., Park, K., Nam, H. Y., Lee, S., Kim, K., & Kwon, I. C. 2007, "Polymers for bioimaging", *Progress in Polymer Science*, vol. 32, no. 8-9, pp. 1031-1053.

Kinnear, M., Ghosh, S., & Hudson, S. 1999, "Gastro-oesophageal reflux disease", *Pharm J*, vol. 263, no. 241, p. 250.

Klastersky, J. 2004, "Antifungal therapy in patients with fever and neutropenia—more rational and less empirical?", *N Engl J Med*, vol. 351, no. 14, pp. 1445-1447.

Knapczyk, J., Macura, A. B., & Pawlik, B. 1992, "Simple tests demonstrating the antimycotic effect of chitosan", *Int J Pharm*, vol. 80, no. 1-3, pp. 33-38.

Koek, G. H., Vos, R., Flamen, P., Sifrim, D., Lammert, F., Vanbilloen, B., Janssens, J., & Tack, J. 2004, "Oesophageal clearance of acid and bile: a combined radionuclide, pH, and Bilitec study", *Gut*, vol. 53, pp. 21-26.

Koletar, S. L., Russell, J. A., Fass, R. J., & Plouffe, J. F. 1990, "Comparison of oral fluconazole and clotrimazole troches as treatment for oral candidiasis in patients infected with human immunodeficiency virus", *Antimicrob Agents Chemother*, vol. 34, pp. 2267C2268.

Kovacs, K., Stampf, G., Klebovich, I., Antal, I., & Ludanyi, K. 2008, "Aqueous solvent system for the solubilization of azole compounds", *Eur J Pharm Sci* (article in press)

Kulinna-Cosentini, C., Schima, W., & Cosentini, E. P. 2007, "Dynamic MR imaging of the gastroesophageal junction in healthy volunteers during bolus passage", *Magn Reson Imaging*, vol. 25, pp.749-754.

Kuntsche, J., Westesen, K., Drechsler, M., Koch, M. H., & Bunjes, H. 2004, "Supercooled smectic nanoparticles: a potential novel carrier system for poorly water soluble drugs", *Pharm Res*, vol. 21, no. 10, pp. 1834-1843.

Kushner, D. S. 1981, "A report on the use of Kenalog in Orabase combined with Lomudal (sodium chromoglycate) in the treatment of oral aphthous ulcers", *J Dent Assoc S Afr*, vol. 36, no. 4, p. 279.

Laine, L. 1994, "The natural history of esophageal candidiasis after successful treatment in patients with AIDS", *Gastroenterology*, vol. 107, no. 3, pp. 744-746.

Laine, L. & Rabeneck, L. 1995, "Prospective study of fluconazole suspension for the treatment of oesophageal candidiasis in patients with AIDS", *Aliment Pharmacol Ther*, vol. 9, no. 5, pp. 553-556.

Lambert, R. & Hainaut, P. 2007, "The multidisciplinary management of gastrointestinal cancer. Epidemiology of oesophagogastric cancer", *Best Pract Res Clin Gastroenterol*, vol. 21, no. 6, pp. 921-945.

Lee, J. I., Park, H., Kim, J. H., Lee, S. I., & Conklin, J. L. 2003, "The effect of sildenafil on oesophageal motor function in healthy subjects and patients with nutcracker oesophagus", *Neurogastroenterol Motil*, vol. 15, no. 6, pp. 617-623.

Lehr, C. M., Bouwstra, J. A., Bodde, H. E., & Junginger, H. E. 1992, "A surface energy analysis of mucoadhesion: contact angle measurements on polycarbophil and pig intestinal mucosa in physiologically relevant fluids", *Pharm Res*, vol. 9, no. 1, pp. 70-75.

Liew, C. V., Chan, L. W., Ching, A. L., & Heng, P. W. 2006, "Evaluation of sodium alginate as drug release modifier in matrix tablets", *Int J Pharm*, vol. 309, no. 1-2, pp. 25-37.

Li, Q., Castell, J. A., & Castell, D. O. 1994, "Manometric determination of esophageal length", *Am J Gastroenterol*, vol. 89, no. 5, pp. 722-725.

Lim, S. P., Luo, L., Maysinger, D., & Eisenberg, A. 2002, "Incorporation and Release of Hydrophobic Probes in Biocompatible Polycaprolactone-*b*-poly(ethylene oxide) Micelles: Implications for Drug Delivery", *Langmuir*, vol. 18, no. 25, pp. 9996-10004.

Lin, X., Hou, W., & Zhu, C. 2003, "Enantiomer separation of miconazole by capillary electrophoresis with dual cyclodextrin systems", *Anal Sci*, vol. 19, no. 11, pp. 1509-1512.

Lin, O. S., Schembre, D. B., Mergener, K., Spaulding, W., Lomah, N., Ayub, K., Brandabur, J. J., Bredfeldt, J., Drennan, F., Gluck, M., Jiranek, G. C., McCormick, S. E., Patterson, D., & Kozarek, R. A. 2007, "Blinded comparison of esophageal capsule endoscopy versus conventional endoscopy for a diagnosis of Barrett's esophagus in patients with chronic gastroesophageal reflux", *Gastrointestinal Endoscopy*, vol. 65, no. 4, pp. 577-583.

Llabot, J. M., Manzo, R. H., & Allemandi, D. A. 2004, "Drug release from carbomer: carbomer sodium salt matrices with potential use as mucoadhesive drug delivery system", *Int J Pharm*, vol. 276, no. 1-2, pp. 59-66.

Llabot, J. M., Palma, S. D., Manzo, R. H., & Allemandi, D. A. 2007, "Design of novel antifungal mucoadhesive films: Part II. Formulation and *in vitro* biopharmaceutical evaluation", *Int J Pharm*, vol. 336, no. 2, pp. 263-268.

Long, J. D. & Orlando, R. C. 1999, "Esophageal submucosal glands: structure and function", *Am J Gastroenterol*, vol. 94, no. 10, pp. 2818-2824.

Lowman, A. M. & Peppas, N. A. 2000, "Molecular analysis of interpolymer complexation in graft copolymer networks", *Polymer*, vol. 41, no. 1, pp. 73-80.

Lozada-Nur, F. I. & Sroussi, H. Y. 2006, "Tacrolimus powder in Orabase 0.1% for the treatment of oral lichen planus and oral lichenoid lesions: an open clinical trial", *Oral Surg Oral Med Oral Pathol Oral Radiol Endod*, vol. 102, no. 6, pp.

744-749.

Lozada-Nur, F., Miranda, C., & Maliksi, R. 1994, "Double-blind clinical trial of 0.05% clobetasol propionate (corrected from proprionate) ointment in orabase and 0.05% fluocinonide ointment in orabase in the treatment of patients with oral vesiculoerosive diseases", *Oral Surg Oral Med Oral Pathol Oral Radiol Endod*, vol. 77, no. 6, pp. 598-604.

Lu, C., Lu, Y., Chen, J., Zhang, W., & Wu, W. 2007, "Synchronized and sustained release of multiple components in silymarin from erodible glyceryl monostearate matrix system", *Eur J Pharm Biopharm*, vol. 66, no. 2, pp. 210-219.

Maggi, L., Segale, L., Conti, S., Ochoa, M. E., Salini, A., & Conte, U. 2005, "Preparation and evaluation of release characteristics of 3TabGum, a novel chewing device", *Eur.J.Pharm.Sci.*, vol. 24, no. 5, pp. 487-493.

Mandal, T. K. 2000, "Swelling-controlled release system for the vaginal delivery of miconazole", *Eur J Pharm Biopharm*, vol. 50, no. 3, pp. 337-343.

Marcinkiewicz, J., Polewska, A., & Knapczyk, J. 1991, "Immunoadjuvant properties of chitosan", *Arch Immunol Ther Exp (Warsz.)*, vol. 39, no. 1-2, pp. 127-132.

Martins, M. D. & Rex, J. H. 1997, "Fluconazole suspension for oropharyngeal candidiasis unresponsive to tablets ", *Ann Intern Med*, vol. 126, pp. 332-333.
Ref Type: Abstract

McCabe, M. L. & Dlamini, Z. 2005, "The molecular mechanisms of oesophageal cancer", *Int Immunopharmacol*, vol. 5, no. 7, pp. 1113-1130.

McCargar, L., Crail, D., Dansereau, R., Myers, W., & Lane, M. 2001, "The in-vitro porcine adhesion model is not predictive of the esophageal transit of risedronate tablets in humans", *Int J Pharm*, vol. 222, no. 2, pp. 191-197.

McCarron, P. A., Donnelly, R. F., Canning, P. E., McGovern, J. G., & Jones, D. S. 2004, "Bioadhesive, non-drug-loaded nanoparticles as modulators of candidal adherence to buccal epithelial cells: a potentially novel prophylaxis for candidosis", *Biomaterials*, vol. 25, no. 12, pp. 2399-2407.

McCarthy, L. G., Bradley, G., Sexton, J. C., Corrigan, O. I., & Healy, A. M. 2004, "Computational fluid dynamics modeling of the paddle dissolution apparatus: agitation rate, mixing patterns, and fluid velocities", *AAPS Pharm Sci Tech.*, vol. 5, no. 2, p. e31.

McConville, J. T., Ross, A. C., Florence, A. J., & Stevens, H. N. 2005, "Erosion characteristics of an erodible tablet incorporated in a time-delayed capsule device", *Drug Dev Ind Pharm*, vol. 31, no. 1, pp. 79-89.

Messmann, H., Knuchel, R., Baumler, W., Holstege, A., & Scholmerich, J. 1999, "Endoscopic fluorescence detection of dysplasia in patients with Barrett's esophagus, ulcerative colitis, or adenomatous polyps after 5-aminolevulinic acid-induced protoporphyrin IX sensitization", *Gastrointestinal Endoscopy*, vol. 49, no. 1, pp. 97-101. B. A.

Miller-Chou, B. A., & Koenig, J. L. 2003, "A Review of Polymer Dissolution", *Prog Polym Sci*, vol. 28, pp. 1223-1270 *Macromolecules*, 2002, 35, 440C444

Miller, L., Schiano, T., Ter, R., Parkman, H., Cohen, S., & Fisher, N. 1995, "Injection of botulinum toxin relieves symptoms in patients with diffuse esophageal spasms and non-specific esophageal motility disorders", *Gastroenterology*, vol. 108, p. 168.

Minghetti, P., Cilurzo, F., Casiraghi, A., & Montanari, L. 1999a, "Application of viscometry and solubility parameters in miconazole patches development", *Int J Pharm*, vol. 190, no. 1, pp. 91-101.

Mirza, T., Yatindra, J., Qian, J. L., & Vivilecchia, R. 2005, "Evaluation of Dissolution Hydrodynamics in the USP, Peak and Flat-Bottom Vessels Using Different Solubility Drugs", *Dissolution Technol*, vol. 12, pp. 11C16

Missaghi, S. & Fassihi, R. 2005, "Release characterization of dimenhydrinate from an eroding and swelling matrix: selection of appropriate dissolution apparatus", *Int J Pharm*, vol. 293, no. 1-2, pp. 35-42.

Mittal, R. K. 1997 "Pharmacotherapy of the Esophageal Motor Disorders," in *Gastrointestinal Pharmacology and Therapeutics*, G. Friedman, E. D. Jacobson, & R. W. McCallum, eds., Lippincott-Raven Publishers, Philadelphia, pp. 97-102.

Mohammadi-Samani, S., Bahri-Najafi, R., & Yousefi, G. 2005, "Formulation and *in vitro* evaluation of prednisolone buccoadhesive tablets", *Farmaco*, vol. 60, no. 4, pp. 339-344.

Mohammed, F. A. & Khedr, H. 2003, "Preparation and *in vitro/in vivo* evaluation of the buccal bioadhesive properties of slow-release tablets containing miconazole nitrate", *Drug Dev Ind Pharm*, vol. 29, no. 3, pp. 321-337.

Morihara, M., Aoyagi, N., Kaniwa, N., Katori, N., & Kojim, S. 2002, "Hydrodynamic flows around tablets in different pharmacopeial dissolution tests", *Drug Dev Ind Pharm*, vol. 28, no. 6, pp. 655-662.

Mortazavi, S. A. 1995, "An *in vitro* assessment of mucus/mucoadhesive interactions", *Int J Pharm*, vol. 124, no. 2, pp. 173-182.

Mortazavi, S. A. & Smart, J. D. 1995, "An investigation of some factors influencing the *in vitro* assessment of mucoadhesion", *Int J Pharm*, vol. 116, pp. 223-230.

Muzzarelli, R. A., Ilari, P., & Petrarulo, M. 1994, "Solubility and structure of N-carboxymethylchitosan", *Int J Biol Macromol*, vol. 16, no. 4, pp. 177-180

Muzzarelli, R., Tarsi, R., Filippini, O., Giovanetti, E., Biagini, G., & Varaldo, P. E. 1990, "Antimicrobial properties of N-carboxybutyl chitosan", *Antimicrob Agents Chemother*, vol. 34, no. 10, pp. 2019-2023.

Muzzarelli, C., Tosi, G., Francescangeli, O., & Muzzarelli, R. A. 2003, "Alkaline chitosan solutions", *Carbohydr Res*, vol. 338, no. 21, pp. 2247-2255.

Myers, R. L. & Orlando, R. C. 1992, "*In vivo* bicarbonate secretion by human esophagus", *Gastroenterology*, vol. 103, pp. 1174-1178.

Nafee, N. A., Ismail, F. A., Boraie, N. A., & Mortada, L. M. 2003, "Mucoadhesive buccal patches of miconazole nitrate: *in vitro/in vivo* performance and effect of ageing", *Int J Pharm*, vol. 264, no. 1-2, pp. 1-14.

Nakamura, F., Ohta, R., Machida, Y., & Nagai, T. 1996, "*In vitro* and *in vivo* nasal mucoadhesion of some water-soluble polymers", *Int J Pharm*, vol. 134, no. 1-2, pp. 173-181.

Namiot, Z., Rourk, R. M., Piascik, R., Hetzel, D. P., Sarosiek, J., & McCallum, R. W. 1994a, "Interrelationship between esophageal challenge with mechanical and chemical stimuli and salivary protective mechanisms", *Am J Gastroenterol*, vol. 89, no. 4, pp. 581-587.

Namiot, Z., Sarosiek, J., Rourk, R. M., Hetzel, D. P., & McCallum, R. W. 1994b, "Human esophageal secretion: Mucosal response to luminal acid and pepsin", *Gastroenterology*, vol. 106, pp. 973-981.

Narasimhan, B. 2001, "Mathematical models describing polymer dissolution: consequences for drug delivery", *Adv Drug Deliv Rev*, vol. 48, no. 2-3, pp. 195-210.

National Committee for Clinical Laboratory Standards. Reference method for broth dilution antifungal susceptibility testing of yeasts. Approved standard M27-A. Wayne, Pa: National Committee for Clinical Laboratory Standards; 1997.

Needleman, I. G. & Smales, F. C. 1995, "In vitro assessment of bioadhesion for periodontal and buccal drug delivery", *Biomaterials*, vol. 16, no. 8, pp. 617-624.

Needleman, I. G., Smales, F. C., & Martin, G. P. 1997, "An investigation of bioadhesion for periodontal and oral mucosal drug delivery", *J Clin Periodontol*, vol. 24, no. 6, pp. 394-400.

Nerurkar, J., Jun, H. W., Price, J. C., & Park, M. O. 2005, "Controlled-release matrix tablets of ibuprofen using cellulose ethers and carrageenans: effect of formulation factors on dissolution rates", *Eur J Pharm Biopharm*, vol. 61, no. 1-2, pp. 56-68.

Newman, S., Hirst, P., & Wilding, I. 2003, "New developments in radionuclide imaging for assessing drug delivery in man", *Eur J Pharm Sci*, vol. 18, pp. 19-22.

NICE. National Institute for Clinical Excellence. 2000, "Technology Appraisal Guidance No. 7: Guidance on the use of proton pump inhibitors in the treatment of dyspepsia". Ref Type: Pamphlet

Orlando, R. C. 2000, "Mechanisms of reflux-induced epithelial injuries in the esophagus", *Am J Med*, vol. 108, no. 4, Supplement 1, pp. 104-108.

Park, C. R. & Munday, D. L. 2004, "Evaluation of selected polysaccharide excipients in buccoadhesive tablets for sustained release of nicotine", *Drug Dev Ind Pharm*, vol. 30, no. 6, pp. 609-617.

Park, H. & Robinson, J. R. 1985, "Physico-chemical properties of water insoluble polymers important to mucin/epithelial adhesion", *J Controlled Release*, vol. 2, pp. 47-57.

Park, H. & Robinson, J. R. 1987, "Mechanisms of mucoadhesion of poly(acrylic

acid) hydrogels", *Pharm Res*, vol. 4, no. 6, pp. 457-464.

Patel, V. M., Prajapati, B. G., Patel, J. K., & Patel, M. M. 2006, "Physico-chemical characterization and evaluation of buccal adhesive patches containing propranolol hydrochloride", *Curr Drug Deliv*, vol. 3, no. 3, pp. 325-331.

Pather, S. I., Robinson, J. R., Eichman, J. D., Khankari, R. K., Hontz, J., & Gupte, S. V. 2004, Effervescent drug delivery system for oral administration (patent).

Pavelic, R. A. 1960, "Use of an analgesic-antibiotic chewing troche (orabitic) in post-tonsillectomy and adenoidectomy complications", *Eye Ear Nose Throat Mon.*, vol. 39, pp. 644-645.

Pedersen, M., Jacobsen, J., & Sorensen, A. M. 1999, "Cyclodextrin inclusion complexes of miconazole and econazole—isolation, toxicity on human cells, and confirmation of a new interpretation of the drug supersaturation phenomenon", *Drug Dev Ind Pharm*, vol. 25, no. 4, pp. 463-470.

Pedersen, M. & Rassing, M. R. 1990, "Miconazole chewing gum as a drug delivery system application of solid dispersion technique and lecithin", *Drug Dev Ind Pharm*, vol. 16, pp. 2015-2030

Peppas, N. A. & Sahlin, J. J. 1989, "A simple equation for the description of solute release. III. Coupling of diffusion and relaxation", *Int J Pharm*, vol. 57, pp.169-172.

Perioli, L., Ambrogi, V., Rubini, D., Giovagnoli, S., Ricci, M., Blasi, P., & Rossi, C. 2004, "Novel mucoadhesive buccal formulation containing metronidazole for the treatment of periodontal disease", *J Control Release*, vol. 95, no. 3, pp. 521-533.

Perkins, A. C., Wilson, C. G., Blackshaw, P. E., Vincent, R. M., Dansereau,

R. J., Juhlin, K. D., Bekker, P. J., & Spiller, R. C. 1994, "Impaired oesophageal transit of capsule versus tablet formulations in the elderly", *Gut*, vol.35, pp. 1363-1367.

Pickens, A. & Orringer, M. 2003, "Geographical distribution and racial disparity in esophageal cancer", *Ann Thorac Surg*, vol. 76, p. S1367-S1369.

Piel, G., Hayette, M. P., Pavoni, E., Evrard, B., Van, H. T., de Hassonville, S. H., De, M. P., & Delattre, L. 2001, "In vitro comparison of the antimycotic activity of a miconazole-HP-beta-cyclodextrin solution with a miconazole surfactant solution", *J Antimicrob Chemother*, vol. 48, no. 1, pp. 83-87.

Pillay, V. & Fassihi, R. 1998, "Evaluation and comparison of dissolution data derived from different modified release dosage forms: an alternative method", *J Controlled Release*, vol. 55, no. 1, pp. 45-55.

Pillay, V. & Fassihi, R. 1999, "Unconventional dissolution methodologies", *J.Pharm.Sci.*, vol. 88, no. 9, pp. 843-851.

Ponchel, G., Montisci, M. J., Dembri, A., Durrer, C., & Duchene. D. 1997, "Mucoadhesion of colloidal particulate systems in the gastro-intestinal tract", *Eur J Pharm Biopharm*, vol. 44, pp. 25-31

Potts, A. M., Jackson, S., Washington, N., Gilchrist, P., Ron, E. S., Schiller, M., & Wilson, C. G. 1997, "*In vivo* determination of the oesophageal retention of Smart Hydrogel 108", p. 335.

Potts, A. M., Wilson, C. G., Stevens, H. N. E., Dobrozi, D. J., Washington, N., Frier, M., & Perkins, A. C. 2000, "Oesophageal bandaging: a new opportunity for thermosetting polymers", *S T P Pharma Sci*, vol. 10, no. 4, pp. 293-301.

Quigley, E. M. M. & Turnberg, L. A. 1987, "pH of the microclimate lining human gastric and duodenal mucosa *in vivo*. Studies in control subjects and in duodenal

ulcer patients", *Gastroenterology*, vol. 92, pp. 1876-1884.

Qureshi, S. A. 2004, "Choice of rotation speed (rpm) for bio-relevant drug dissolution testing using a crescent-shaped spindle", *Eur.J.Pharm.Sci.*, vol. 23, no. 3, pp. 271-275.

Rao, P. R., & Diwan, P. V. 1998, "Formulation and *in vitro* evaluation of polymeric films of diltiazem hydrochloride and indomethacin for transdermal administration", *Drug Dev Ind Pharm*, vol. 24, no. 4, pp. 327-336.

Rao, S. S., Hayek, B., & Summers, R. W. 1995, "Impedance planimetry: an integrated approach for assessing sensory, active, and passive biomechanical properties of the human esophagus.", *Am J Gastroenterol*, vol. 90, pp. 431-438. Ref Type: Abstract

Remunan-Lopez, C., Portero, A., Vila-Jato, J. L., & Alonso, M. J. 1998, "Design and evaluation of chitosan/ethylcellulose mucoadhesive bilayered devices for buccal drug delivery", *J Control Release*, vol. 55, no. 2-3, pp. 143-152.

Richardson, J. C., Dettmar, P. W., Hampson, F. C., & Melia, C. D. 2004, "Oesophageal bioadhesion of sodium alginate suspensions: particle swelling and mucosal retention", *Eur J Pharm Sci*, vol. 23, no. 1, pp. 49-56.

Richardson, J. C., Dettmar, P. W., Hampson, F. C., & Melia, C. D. 2005, "Oesophageal bioadhesion of sodium alginate suspensions 2. Suspension behaviour on oesophageal mucosa", *Eur J Pharm Sci*, vol. 24, no. 1, pp. 107-114.

Richert, H., Surzhenko, O., Wangemann, S., Heinrich, J., & Gornert, P. 2005, "Development of a magnetic capsule as a drug release system for future applications in the human GI tract", *J Magn Magn Mater*, vol. 293, no. 1, pp. 497-500.

Richter, J. 2001, "Oesophageal motility disorders", *Lancet*, vol. 358, pp. 823-828.

Riley, R. G., Smart, J. D., Tsibouklis, J., Young, S. A., Hampson, F., Davis, A., Kelly, G., Dettmar, P. W., & Wilber, W. R. 2002, "An *in vitro* model for investigating the gastric mucosal retention of ¹⁴C-labelled poly(acrylic acid) dispersions", *Int J Pharm*, vol. 236, pp.87-96

Rindum, J. L., Holmstrup, P., Pedersen, M., Rassing, M. R., & Stoltze, K. 1993, "Miconazole chewing gum for treatment of chronic oral candidosis", *Scand J Dent Res*, vol. 101, no. 6, pp. 386-390.

Rivier, V. 2007, Confectionery product containing functional ingredients and method of making and using, 7214396, Nestec S.A., (patent).

Rodriguez, C. F., Bruneau, N., Barra, J., Alfonso, D., & Doelker, E. 2000, "Hydrophilic cellulose derivatives as drug delivery carriers: Influence of substitution type on the properties of compressed matrix tablets", in *Handbook of Pharmaceutical Controlled Release Technology*, D. L. Wise, ed., Marcel Dekker, Basel, pp. 1-30.

Ron, E. S., Bromberg, L., & Temchenko, M. 2001, End modified thermal responsive hydrogels (patent).

Ruissen, A. L. A., van der Reijden, W. A., van't Hof, W., Veerman, E. C. I., & Nieuw Amerongen, A. V. 1999, "Evaluation of the use of xanthan as vehicle for cationic antifungal peptides", *J Controlled Release*, vol. 60, no. 1, pp. 49-56.

Sakkinen, M., Marvola, J., Kanerva, H., Lindevall, K., Ahonen, A., & Marvola, M. 2004, "Scintigraphic verification of adherence of a chitosan formulation to the human oesophagus", *Eur J Pharm Biopharm*, vol. 57, pp. 145-147.

Sako, K., Sawada, T., Nakashima, H., Yokohama, S., & Sonobe, T. 2002, "Influence of water soluble fillers in hydroxypropylmethylcellulose matrices on *in vitro* and *in vivo* drug release", *J Controlled Release*, vol. 81, no. 1-2, pp. 165-172.

Salamat-Miller, N., Chittchang, M., & Johnston, T. P. 2005, "The use of mucoadhesive polymers in buccal drug delivery", *Adv Drug Deliv Rev*, vol. 57, pp. 1666-91.

Salsa, T., Veiga, F., Teixeira-Dias, J. J. C., & Pina, M. E. 2003, "Effect of polymer hydration on the kinetic release of drugs: a study of ibuprofen and ketoprofen in HPMC matrices", *Drug Dev Ind Pharm*, vol. 29, no. 3, pp. 289-297.

Sampliner, R. E. 1998, "Practice guidelines on the diagnosis, surveillance, and therapy of Barrett's esophagus", *Am J Gastroenterol*, vol. 93, no. 7, pp. 1028-1032.

Sandler, R. 1995, "The risk of esophageal cancer in patients with achalasia. A population-based study", *JAMA*, vol. 274, no. 17, pp. 1359-1362.

Sandolo, C., Coviello, T., Matricardi, P., & Alhaique, F. 2007, "Characterization of polysaccharide hydrogels for modified drug delivery", *Eur Biophys J*, vol. 36, no. 7, pp. 693-700.

Sandri, G., Rossi, S., Ferrari, F., Bonferoni, M. C., Zerrouk, N., & Caramella, C. 2004, "Mucoadhesive and penetration enhancement properties of three grades of hyaluronic acid using porcine buccal and vaginal tissue, Caco-2 cell lines, and rat jejunum", *J Pharm Pharmacol*, vol. 56, no. 9, pp. 1083-1090.

Sarosiek, J., Namiot, Z., & Piascik, R. 1993, "What part do the mucous cells of submucosal mucous glands play in the esophageal pre-epithelial barrier", Paris.

Savarino, V. & Dulbecco, P. 2004, "Optimizing symptom relief and preventing complications in adults with gastro-oesophageal reflux disease", *Digestion*, vol. 69, no. Suppl 1, pp. 9-16.

Senel, S., Ikinici, G., Kas, S., Yousefi-Rad, A., Sargon, M. F., & Hincal, A. A. 2000, "Chitosan films and hydrogels of chlorhexidine gluconate for oral mucosal

delivery", *Int J Pharm*, vol. 193, no. 2, pp. 197-203.

Seo, H., Shoji, A., Itoh, Y., Kawamura, M., & Sakagami, Y. 1994, "Antibacterial fiber blended with chitosan", In: Karnicki, Z. S., Brzeski, M. M., Bykowski, P. J., & Wojtasz-Pajak, A. 1994, "Chitin World", Wirtschaftsverlag NV-Verlag für neue Wissenschaft GmbH, Germany, pp. 623-631.

Sharma, J. B., Mittal, S., Raina, U., & Chanana, C. 2006, "Comparative efficacy of two regimens in syndromic management of lower genital infections", *Arch Gynecol Obstet*, vol. 273, no. 4, pp. 232-235.

Siepmann, J. & Peppas, N. A. 2001, "Modeling of drug release from delivery systems based on hydroxypropyl methylcellulose (HPMC)", *Adv Drug Deliv Rev*, vol. 48, no. 2-3, pp. 139-157.

Siewert, M., Dressman, J., Brown, C. K., & Shah, V. P. 2003, "FIP/AAPS guidelines to dissolution/in vitro release testing of novel/special dosage forms", *AAPS Pharm Sci Tech.*, vol. 4, pp. E7.

Sigurdsson, H. H., Loftsson, T., & Lehr, C. M. 2006, "Assessment of mucoadhesion by a resonant mirror biosensor", *Int J Pharm*, vol. 325, pp. 75-81

Singla, A. K. & Chawla, M. 2001, "Chitosan: some pharmaceutical and biological aspects—an update", *J Pharm Pharmacol*, vol. 53, no. 8, pp. 1047-1067.

Sloan, S., Rademaker, A. W., & Kahrilas, P. J. 1992, "Determinants of gastroesophageal junction incompetence: hiatal hernia, lower esophageal sphincter, or both?", *Ann Intern Med*, vol. 117, no. 12, pp. 977-982.

Smart, J. D., Riley, R. G., Tsibouklis, J., Young, S. A., Hampson, F. C., Davis, J. A., Kelly, G., Dettmar, P. W., & Wilber, W. R., 2003 "The retention of ¹⁴C-labelled poly(acrylic acids) on gastric and oesophageal mucosa: an *in vitro* study", *E J Pharm Sci*, vol. 20, pp.83-90.

Solaymani-Dodaran, M., Logan, R., West, J., Card, T., & Coupland, C. 2004, "Risk of oesophageal cancer in Barrett's oesophagus and gastro-oesophageal reflux", *Gut*, vol. 53, no. 8, pp. 1070-1074.

Sperandio, M., Gideon, M., Tutuian, R., Katz, P. O., & Castell, D. O. 2002, "Diffuse esophageal spasm (DES): it is not diffuse but distal esophageal spasm", *Am J Gastroenterol*, vol. 97, no. 9, Supplement 1, p. S10-S11.

Stanley, T. H. & Hague, B. 1994, Compositions of oral dissolvable medicaments (patent).

Stanley, T. H. & Hague, B. 1999, Non-dissolvable drug-containing dosage-forms for use in the transmucosal delivery of a drug to a patient (patent).

Staroniewicz, Z., Ramisz, A., Wojtasz-Pajak, A., & Brzeski, M. M. 1994, "Studies on antibacterial and antifungal activity of chitosan" In: Karnicki, Z. S., Brzeski, M. M., Bykowski, P. J., & Wojtasz-Pajak, A. 1994, "Chitin World", *Wirtschaftsverlag NV-Verlag für neue Wissenschaft GmbH, Germany*, pp. 374-377.

Stevens, A. & Lowe, J. 1997, *Human Histology*, 2nd edn, Mosby, London.

Sudhakar, Y., Kuotsu, K., & Bandyopadhyay, A. K. 2006, "Buccal bioadhesive drug delivery - A promising option for orally less efficient drugs", *J Controlled Release*, vol. 114, no. 1, pp. 15-40.

Suzuki, H., Onishi, H., Takahashi, Y., Iwata, M., & Machida, Y. 2003, "Development of oral acetaminophen chewable tablets with inhibited bitter taste", *Int J Pharm*, vol. 251, no. 1-2, pp. 123-132.

Suzuki, H., Onishi, H., Hisamatsu, S., Masuda, K., Takahashi, Y., Iwata, M., & Machida, Y. 2004, "Acetaminophen-containing chewable tablets with suppressed

bitterness and improved oral feeling", *Int J Pharm*, vol. 278, no. 1, pp. 51-61.

Talukdar, M. M., Vinckier, I., Moldenaers, P., & Kinget, R. 1996, "Rheological characterization of xanthan gum and hydroxypropylmethyl cellulose with respect to controlled-release drug delivery", *J Pharm Sci*, vol. 85, no. 5, pp. 537-540.

Tamhankar, A., Almogy, G., Arain, M., Portale, G., Hagen, J., Peters, J., Crookes, P., Sillin, L., DeMeester, S., Bermner, C., & DeMeester, T. 2003, "Surgical management of hypertensive lower esophageal sphincter with dysphagia or chest pain", *J Gastrointest Surg*, vol. 7, no. 8, pp. 990-996.

Tang, M. 2004, "Investigation of liquid sodium alginates as mucoadhesive bandages coating the oesophageal mucosa and protectinf it from gastric reflux", PhD thesis, Aston University, Birmingham, United Kingdom.

Tang, M., Dettmar, P., & Batchelor, H. 2005, "Bioadhesive oesophageal bandages: protection against acid and pepsin injury", *Int J Pharm*, vol. 292, no. 1-2, pp. 169-177.

Tenjarla, S., Puranajoti, P., Kasina, R., & Mandal, T. 1998, "Preparation, characterization, and evaluation of miconazole-cyclodextrin complexes for improved oral and topical delivery", *J Pharm Sci*, vol. 87, no. 4, pp. 425-429.

Teran, M., Savio, E., Paolino, A., & Frier, M. 2005, "Hydrophilic and lipophilic radiopharmaceuticals as tracers in pharmaceutical development: *In vitro* - *In vivo* studies", *BMC Nucl Med*, vol. 5, p. 5.

Tobgi, R. S., Samaranayake, L. P., & MacFarlane, T. W. 1987, "Adhesion of *Candida albicans* to buccal epithelial cells exposed to chlorhexidine gluconate", *J Med Vet Mycol*, vol. 25, no. 5, pp. 335-338.

Triadafilopoulos, G., Aaronson, M., Sackel, S., & Burakoff, R. 1991, "Medical Treatment of Esophageal Achalasia", *Dig Dis Sci*, vol. 36, no. 3, pp. 260-267.

Valentine, W. 1987, Quick-liquifying, chewable tablet (patent).

Van, R. J., Haxaire, M., Kanya, M., Lwanga, I., & Katabira, E. 2004, "Comparative efficacy of topical therapy with a slow-release mucoadhesive buccal tablet containing miconazole nitrate versus systemic therapy with ketoconazole in HIV-positive patients with oropharyngeal candidiasis", *J Acquir Immune Defic Syndr*, vol. 35, no. 2, pp. 144-150.

Vandercam, B., Gibbs, D., Valtonen, M., Jager, H., & Armignacco, O. 1998, "Fluconazole orally dispersible tablets for the treatment of patients with oropharyngeal candidiasis", *J Int Med Res*, vol. 26, no. 4, pp. 209-218.

Varshosaz, J. & Dehghan, Z. 2002, "Development and characterization of buccoadhesive nifedipine tablets", *Eur J Pharm Biopharm*, vol. 54, no. 2, pp. 135-141.

Vermani, K., Garg, S., & Zaneveld, L. J. 2002, "Assemblies for *in vitro* measurement of bioadhesive strength and retention characteristics in simulated vaginal environment", *Drug Dev Ind Pharm*, vol. 28, no. 9, pp. 1133-1146.

Vonarx, V., Eleouet, S., Carre, J., Ioss, P., Gouyette, A., Leray, A. M., Merle, C., Lajat, Y., & Patrice, T. 1997, "Potential efficacy of a delta 5-aminolevulinic acid bioadhesive gel formulation for the photodynamic treatment of lesions of the gastrointestinal tract in mice", *J Pharm Pharmacol*, vol. 49, no. 7, pp. 652-656.

Warren, S. J. & Kellaway, I. W. 1998, "The synthesis and *in vitro* characterization of the mucoadhesion and swelling of poly(acrylic acid) hydrogels" *Pharm Dev Technol*, vol. 3, no. 2, pp. 199-208.

Washington, N., Wilson, C. G., Williams, D., & Robertson, C. 1993, "An investigation into the effect of cimetidine pre-treatment on raft formation of an anti-reflux agent", *Aliment Pharmacol Ther*, vol. 7, no. 5, pp. 553-559.

Washington, N., Washington, C., & Wilson, C. 2001, "Oesophageal Transit", in *Physiological Pharmaceutics; barriers to drug absorption*, N. Washington, C. Washington, & C. Wilson, eds., Taylor and Francis, London, pp. 59-73.

Weitschies, W., Cardini, D., Karaus, M., Trahms, L., & Semmler, W., 1999, "Magnetic marker monitoring of esophageal, gastric and duodenal transit of non-disintegrating capsules", *Die Pharmazie* 54(6), pp.426-430.

Wilcox, C. M., Darouiche, R. O., Laine, L., Moskovitz, B. L., Mallegol, I., & Wu, J. 1997, "A randomized, double-blind comparison of itraconazole oral solution and fluconazole tablets in the treatment of esophageal candidiasis", *J Infect Dis*, vol. 176, no. 1, pp. 227-232.

Wilding, I. R., Coupe, A. J., & Davis, S. S. 2001, "The role of gamma-scintigraphy in oral drug delivery", *Adv Drug Deliv Rev*, vol. 46, pp. 103-124.

Williams, R. O., III, Reynolds, T. D., Cabelka, T. D., Sykora, M. A., & Mahaguna, V. 2002, "Investigation of excipient type and level on drug release from controlled release tablets containing HPMC", *Pharm Dev Technol*, vol. 7, no. 2, pp. 181-193.

Wilson, C. G., Washington, N., Norman, S., Greaves, J. L., Peach, J. M., & Pugh, K. 1988, "A gamma scintigraphic study to compare oesophageal clearance of "Expidet" formulations, tablets and capsules in supine", *Int J Pharm*, vol. 46, no. 3, pp. 241-246.

Wilson, C. G., McJury, M., O'Mahony, B., Frier, M., & Perkins, A. C. 1997, "Imaging of oily formulations in the gastrointestinal tract", *Adv Drug Deliv Rev*, vol. 25, no. 1, pp. 91-101.

Wilson, C. G., Zhu, Y., & Frier, M. 1998, "Ocular contact time of a carbomer gel (GelTears) in humans", *Br J Ophthalmol*, vol. 82, pp. 1131-1134.

-
- Wise, J. L., Murray, J. A., & Conklin, J. L. 2004, "Regional differences in oesophageal motor function", *Neurogastroenterol Motil*, vol. 16, no. 1, pp. 31-37.
- Woltman, T. A., Oelschlager, B. K., & Pellegrini, C. A. 2004, "Surgical management of esophageal motility disorders", *J Surg Res*, vol. 117, no. 1, pp. 34-43.
- Wu, Y., Kildsig, D. O., & Ghaly, E. S. 2004, "Effect of hydrodynamic environment on tablets dissolution rate", *Pharm Dev Technol*, vol. 9, no. 1, pp. 25-37.
- Yamsani, V. V., Gannu, R., Kolli, C., Rao, M. E., & Yamsani, M. R. 2007, "Development and *in vitro* evaluation of buccoadhesive carvedilol tablets", *Acta Pharm*, vol. 57, no. 2, pp. 185-197.
- Yang, W., Fung, T. C., Chian, K. S., & Chong, C. K., 2007, "Finite element simulation of food transport through the esophageal body", *World J Gastroenterol*, vol.13, pp.1352-1359.
- Young, S. A., Carpenter, B., Nevel, T. G., & Smart, J. D. 2002, "The factors affecting liquid and semi-solid mucoadhesion to the oral cavity and oesophagus", *J Pharm Pharmacol*, vol. 54, pp.S20-S20
- Yeh, R. W. & Triadafilopoulos, G. 2006, "Injection therapies for nonbleeding disorders of the GI tract", *Gastrointestinal Endoscopy*, vol. 64, no. 3, pp. 399-411.
- Yehia, S. A., El-Gazayerly, O. N., & Basalious, E. B. 2008, "Design and *in vitro/in vivo* evaluation of novel mucoadhesive buccal discs of an antifungal drug: relationship between swelling, erosion, and drug release", *AAPS Pharm Sci Tech*.
- Zatz, J. L. & Knapp, S. 1984, "Viscosity of xanthan gum solutions at low shear rates", *J Pharm Sci*, vol. 73, no. 4, pp. 468-471.

Zhang, L., Russell, D., Conway, B. C., & Batchelor, H. 2008, "Strategies and therapeutic opportunities for the delivery of drugs to the esophagus", *Crit Rev Ther Drug Carrier Syst*, vol. 25, no. 3, pp. 259-304.

Zhang, L. & Batchelor, H. 2004, "A bioadhesive formulation for the delivery of anti-fungal agents to the oesophagus", *J Pharm Pharmacol*, vol. 56 (suppl), p. 44.

Zhao, J., Jrgensen, C. S., Liao, D., & Gregersen, H., 2007, "Dimensions and circumferential stress-strain relation in the porcine esophagus *in vitro* determined by combined impedance planimetry and high-frequency ultrasound", *Digest Dis Sci*, vol. 52, pp.1338-1344.

Zyck, D. J., Greenberg, M. J., Barkalow, D. G., Marske, S. W., Urnezis, P. W., & Mazzone, P. 2003, Antacid chewing gum products coated with high viscosity materials (patent).