

Some pages of this thesis may have been removed for copyright restrictions.

If you have discovered material in AURA which is unlawful e.g. breaches copyright, (either yours or that of a third party) or any other law, including but not limited to those relating to patent, trademark, confidentiality, data protection, obscenity, defamation, libel, then please read our [Takedown Policy](#) and [contact the service](#) immediately

ANALYSIS OF RUBBER VULCANISATES

WILLIAM CHARLES THOMPSON

Doctor of Philosophy

THE UNIVERSITY OF ASTON IN BIRMINGHAM

December 1987

This copy of the thesis has been supplied on condition that anyone who consults it is understood to recognise that its copyright rests with its author and that no quotation from the thesis and no information derived from it may be published without the author's prior, written consent.

THE UNIVERSITY OF ASTON IN BIRMINGHAM

ANALYSIS OF RUBBER VULCANISATES

William Charles Thompson

Submitted for the Degree of PhD

1987

SUMMARY

A study has been made, using High Pressure Liquid Chromatography, of the migration of TMQ (a quinoline type) and 6PPD (a paraphenylenediamine type) antidegradants from a tyre sidewall compound into adjacent casing and liner compounds containing no antidegradant. Migration takes place at a rapid rate, even during the vulcanisation of the composite. After 400 hours ageing in nitrogen at 100°C, there is a higher level of antidegradants in the casing than in the sidewall. An equilibrium distribution is not obtained. After 114 days at 50°C in 95% relative humidity, the level of solvent extractable 6PPD fell to zero, but subsequent ageing for 2 years in 50 ppm ozone showed no evidence of sidewall cracking. It is suggested that the antidegradant is still active but linked to the polymer chain.

An analytical method, for the type and amount of sulphenamide accelerators in vulcanised rubber compounds, has been developed. During the vulcanisation process, the accelerators decay, liberating specific amines which have been solvent extracted, derivatised with 1-chloro-2,4-dinitrobenzene and the yellow coloured zwitter ion analysed using High Pressure Liquid Chromatography.

The decay of the accelerator and sulphur during the vulcanisation process, has been studied. It has been demonstrated that the sulphur crosslinking with a styrene-butadiene polymer is a first order reaction, after an initial period during which the accelerator content falls to zero. Variations in sulphur to accelerator ratios gave consistent rate constants for the crosslinking, except for a sulphur level of less than 1% by weight and a ratio of accelerator to sulphur of 1:1.3. The retention time of the reaction product between sulphur and accelerator from an HPLC column changes with cure time, showing that the precursor to crosslinking is an ever changing material. One of these reaction products has been analysed.

KEY WORDS CHEMICAL ANALYSIS ANTIDEGRADANTS
 ACCELERATORS CROSSLINKING
 RUBBER COMPOUNDS

ACKNOWLEDGMENTS

I would like to give my special thanks to Dr. A.J. Massie for providing guidance, help and supervision throughout the project.

Thanks are also due to my family for allowing me the time and giving the financial assistance to carry out the project.

I would also like to express my gratitude to Mr. H.A. Jones, Mr. C.M. Ashworth, together with the staff of Compounds Laboratory and Curing Section for their help in preparing rubber compound samples for analysis.

Finally, I would like to thank Mr. J.E. Diamond for acting as my external supervisor.

ACKNOWLEDGEMENTS

I would like to give my special thanks to Dr A.J. Amass for providing guidance, help and supervision throughout the project.

Thanks are also due to SP Tyres UK for allowing me the time and giving the financial assistance to carry out the project.

I would also like to express my gratitude to Mr N.A. Jones, Mr C.N. Ashworth, together with the staff of Compounds Laboratory and Curing Section for their help in preparing rubber compound samples for analysis.

Finally, I would like to thank Mr J.E. Diamond for acting as my external supervisor.

LIST OF CONTENTS

	<u>Page</u>
Title Page	1
Summary	2
Dedication	3
Acknowledgements	4
List of Contents	5
List of Tables	10
List of Figures	11
 Chapter One	
 INTRODUCTION AND LITERATURE SURVEY	
1.1. Introduction	12
1.1.1. Passenger Car Tyres	12
1.2. Rubber Compounds	15
1.2.1. Natural Rubber	15
1.2.2. Styrene Butadiene Co-polymers	16
1.2.3. Polybutadiene	18
1.2.4. Carbon Black	20
1.2.5. Resins	23
1.2.6. Antidegradants	23
1.2.7. Curative System	29
1.3. Literature Survey	33
1.3.1. Vulcanisation Mechanisms	33
1.3.2. Structure of Vulcanisates	40
1.4. Analysis of Rubber Compounds	53

1.4.1.	Thin Layer and Spectroscopic Methods	53
1.4.2.	High Pressure Liquid Chromatography	56
1.4.3.	Thermal Analysis Techniques	58
1.4.4.	Mass Spectrometry	59
1.4.5.	Gas Chromatography	59
1.4.6.	Fourier Transform Infrared Spectroscopy	61
1.4.7.	Scanning Electron Microscopy	62
1.5.	Purpose of Present Project	63

Chapter 2

GENERAL EXPERIMENTAL TECHNIQUES

2.1.	High Performance Liquid Chromatography	67
2.1.1.	Procedure	74
2.1.2	Preparative HPLC	75
2.2.	Ultraviolet and Visible Light Spectroscopy	76
2.2.1.	Procedure	76
2.3.	Thin Layer Chromatography	77
2.3.1.	Procedure	78
2.4.	Infrared Spectroscopy	79
2.4.1.	Procedure	80
2.5.	Total Sulphur Analyser	81
2.5.1	Reagents	86
2.5.2	Procedure	86
2.5.3	Calculation of Sulphur Content	87
2.6.	Extraction Methods	88
2.6.1.	Hot Extractions	88
2.6.2.	Cold Extractions	89
2.7.	Compounding of Rubber Samples	89

2.7.1.	Banbury Mixing.	89
2.7.1.1.	Procedure	90
2.7.2.	Open Mill Mixing	92
2.7.3.	Vulcanisation of Compounds	92
2.8.	The Monsanto Rheometer	92
2.8.1.	Procedure	94
2.9.	Low Temperature Pyrolysis	96
2.9.1.	Procedure	97
 Chapter 3		
FATE OF ANTIDEGRADANTS		
3.1.	Introduction	98
3.2.	Formulation of Rubber Compounds	99
3.3.	Manufacture of Test Specimens	99
3.4.	Ageing of Test Specimens	103
3.5.	Preparation of Specimens for Analysis	104
3.6.	Analysis Procedure	104
3.7.	Results	105
3.7.1.	Samples Aged in Nitrogen	106
3.7.2.	Samples Aged at 50°C in 95% Relative Humidity	110
3.7.3.	Heat Ageing of 6PPD Antidegradant	111
3.8.	Conclusions	112
3.8.1.	Nitrogen Ageing	112
3.8.2.	Ageing at 95% Relative Humidity	114
3.8.3.	Heat Ageing	115
3.9.	HPLC Chromatograms	116
3.9.1.	Ageing in Nitrogen - Initial Samples	116
3.9.2.	Samples Aged in 95% Relative Humidity	120

3.9.3.	6PPD Antidegradant Aged at 100°C	121
Chapter 4		
ANALYTICAL METHOD FOR THE DETERMINATION OF		
SULPHENAMIDE ACCELERATORS		
4.1.	Pure Amines	122
4.1.1.	Ultraviolet Spectra of Pure Amines	122
4.1.2.	Liquid Chromatography of Pure Amines	124
4.2.	1-chloro-2,4-dinitrobenzene Derivatives	124
4.2.1.	Procedure	125
4.2.2.	Thin Layer Chromatography	125
4.2.3.	Visible Light Spectroscopy	126
4.2.4	Liquid Chromatography of Amine Derivatives	126
4.3.	Model Compound Systems	130
4.3.1.	HPLC Analysis	131
4.3.2.	Amine Derivatives	131
4.4.	Cured Rubber Compounds	134
4.4.1.	Amine Hydrochlorides	134
4.4.2.	Laboratory Mixed Compounds	136
4.4.2.1.	Analysis for Amines in AN5004 Compound	138
4.5.	Detector Response Factors for Amine Derivatives	141
4.6.	Quantitative Analysis of Rubber Compounds	142
4.6.1.	Results	144
4.7.	Determination of MBT	145
4.8.	Discussion and Conclusions	147

Chapter 5

THE FATE OF ACCELERATOR AND SULPHUR DURING VULCANISATION

5.1	Introduction	149
5.2.	Rubber Compound Formulations	150
5.3.	Rheometry	152
5.3.1.	Preparation of Samples for Analysis	154
5.4.	Analysis by Liquid Chromatography	155
5.4.1.	Results for AO5514 Compound	156
5.4.2.	Discussion of Initial Results	164
5.4.3.	Results for Analysis of AO5514/A Compound	165
5.4.4.	Discussion of AO5514/A Results	173
5.5.	HPLC Analysis of Compounds AN5910/A-E	174
5.5.1.	Discussion of AN5910/A-E Results	185
5.5.3.	Kinetics of the Crosslinking Reaction	188
5.6.	Analysis of the Reaction Product	191

Chapter 6

CONCLUSIONS AND SUGGESTIONS FOR FURTHER WORK

6.1.	Conclusions	198
6.2.	Suggestions for Further Work	201

APPENDIX ONE

HPLC Chromatograms of Antidegradants	203
--------------------------------------	-----

References	209
------------	-----

LIST OF FIGURES

<u>Figure</u>	<u>Page</u>	<u>Figure</u>	<u>Page</u>	<u>Figure</u>	<u>Page</u>
1	14	26	118	52	152
2	15	27	118	53	158
3	18	28	119	54	159
4	19	29	119	55	159
5	19	30	120	56	160
6	19	31	120	57	160
7	35	32	121	58	161
8	44	33	121	59	161
9a	68	34	123	60	162
9b	68	35	123	61	162
10	72	36	123	62	162
11	73	37	128	63	163
12	80	38	129	64	166
13	83	39	129	65	167
14	84	40	132	66	167
15	85	41	133	67	168
16	91	42	133	68	168
17	95	43	135	69	169
18	96	44	135	70	169
19	103	45	136	71	170
20	108	46	139	72	170
21	109	47	140	73	171
22	116	48	140	74	171
23	116	49	141	75	172
24	117	50	146	76	172
25	117	51	147		

CHAPTER 1

INTRODUCTION AND LITERATURE SURVEY

1.1. Introduction

1.1.1 Passenger Car Tyres

A passenger car tyre looks, from its external appearance, to be merely a black, circular, moulded object, but is in actuality a complex and highly technical product.

Each tyre is made up from many individual components, such as tread, sidewall, casing, breakers, bead etc, which are produced by mixing, milling, extrusion or calendering of rubber compounds.

(This term "rubber compound" is a term used in the rubber industry to mean a blend of materials and has no connection with the chemical definition of a compound.)

The individual components of a tyre are carefully designed to perform their tasks so that the final product will behave correctly under the high stress conditions to which it will be subjected.

A tyre should:-

- a. give comfort to the passengers of the vehicle
- b. have low noise levels
- c. have good wear properties
- d. have high grip even in wet conditions
- e. have good stability for straight ahead running
- f. develop high cornering forces
- g. withstand high and low temperatures
- h. withstand attack from ozone and oxygen
- i. carry high loads at high speeds
- j. develop high braking forces
- k. have a relatively low cost.

The above parameters are some, but not all, of the constraints under which tyre designers and compounders have to work.

Apart from ensuring that each rubber compound is correctly formulated so that it will have the desired physical properties of hardness, tensile strength, tear strength, wear, grip, running temperatures etc., it must exhibit high uniformity and balance. This necessitates high levels of accuracy in mixing, extruding, calendering, cutting and shaping.

The individual components are consolidated on a tyre building machine, where an operator places each in turn on a rotating former to produce an unvulcanised tyre called a "green cover".

Radial ply construction, where all the casing cords run across the tyre from bead to bead, necessitates the pre-shaping of a green cover, from a cylindrical shape to a tyre shape, before the breaker cords and tread can be fitted.

The final stage is to place the green cover in a mould, where internal pressure and heat force the semi-molten rubber into a steel and aluminium mould to produce the finished tyre complete with tread pattern and sidewall markings. This vulcanisation process gives a permanent set to the tyre so that it will retain its shape throughout its life.

FIGURE 1

THE CONSTRUCTION OF A RADIAL PLY TYRE

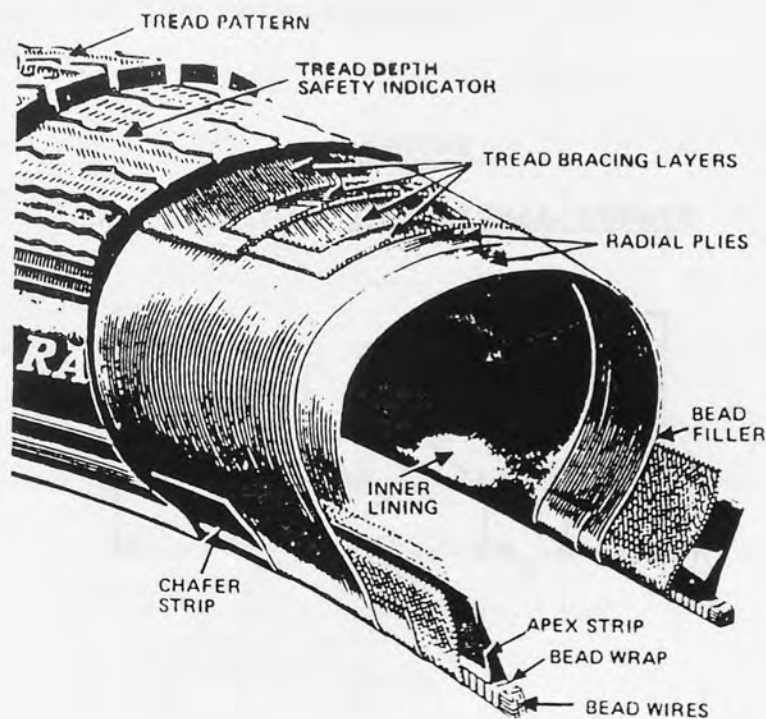

1.2. Rubber Compounds

1.2.1. Natural Rubber (NR)

Natural Rubber, commonly obtained from the latex of the Hevea Braziliensis tree, is used in aircraft, truck and earthmover tyres where high tear strength, excellent wear and good stability to heat are the properties required. A typical weight analysis (1) shows that solid is approximately 94% rubber hydrocarbon, 3% acetone extract, 2.5% protein, 0.3% ash, the remainder being water.

Natural rubber is a poly(olefin) with internal double bonds that conforms to the classical reactions of olefins e.g. its ability to undergo addition reactions at the double bonds.

Work by Gladstone and Hibbert (2), Weber (3) and Pummerer et al, (4) has shown that the structure of natural rubber is cis 1.4. polyisoprene.

FIGURE 2

STRUCTURE OF NATURAL RUBBER

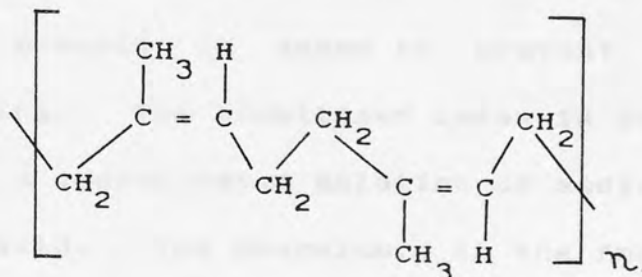

1.2.2. Styrene Butadiene Copolymers (SBR)

The styrene butadiene copolymers are the most widely used of all the synthetic polymers in tyre manufacture. They were developed during the period 1945-1948, particularly "Cold Rubber", where the polymerisation process was carried out at 5°C, and led to the present day Low Temperature Polymers (LTP).

SBR is manufactured by feeding butadiene and styrene into a reactor which is kept at 5°C. The monomers are emulsified in a rosin acid soap solution and polymerisation is initiated by catalytic promoters. The reaction takes about 8 hours and is stopped when the Mooney viscosity is about 50{ML(1+4)100°C}. A chemical known as a "short-stop", usually a dithiocarbamate, is added to stop the reaction, when 60 to 65% of the monomers have been converted to the copolymer.

The excess monomers are removed by evaporation and recovered for re-use. The polymer is stored in large tanks as a white latex with a solids content of about 23%. Prior to coagulation a stabiliser such as Wingstay S (a styrenated phenol) is added to prevent gel formation during drying. The stabilised latex is fed into a vat containing a concentrated solution of sodium chloride in sulphuric acid. The coagulum, in the form of a rubbery crumb, is washed with hot water then dried, when it is then pressed into 35 kg bales.

A typical LTP such as SBR 1502 has the following characteristics:-

Specific Gravity	0.95
Solvent Extract	4.75-7.75 wt %
Soap	0.5 wt % max
Bound Styrene	22.5 - 23.5 wt % max
Organic acids	4.7-7.2 wt %
Stabiliser	1.5 wt %
Ash	1.0 wt % max
Mooney Viscosity	49 - 55
Volatile Matter	0.75 wt % max

SBR can be obtained as an oil extended polymer.(OEP) The polymerisation of the monomers is taken to a much higher mooney viscosity, ML(1+4)100^oC of 110/120, then reduced down to a Mooney viscosity of 50 by adding oil to the emulsion before coagulation. Highly aromatic oils are used and the common level of oil extension is 37.5 parts of oil to 100 parts of polymer.

A typical OEP such as SBR 1712 has the following characteristics:-

Specific Gravity	0.96
Solvent Extract	30-35 wt %
Soap	0.5 wt % max
Bound Styrene	22.5 - 23.5 wt %
Organic acid	3.9-5.9 wt %
Stabiliser	1.5 wt %

Ash	1.0 wt% max
Mooney Viscosity	46 - 51
Volatile Matter	0.75 wt % max

SBR is a random copolymer of styrene and butadiene, normally containing 23% by weight of styrene, but this can go as high as 40% by weight in some polymers. The units in the backbone are shown in Figure 3.

FIGURE 3

BACKBONE STRUCTURES IN A STYRENE-BUTADIENE COPOLYMER

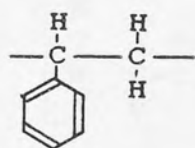

(STYRENE)

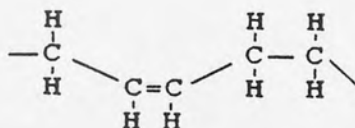

(CIS 1.4. BUTADIENE)

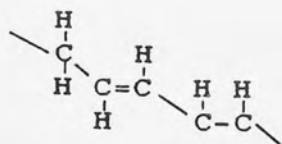

(TRANS 1.4. BUTADIENE)

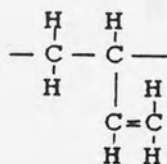

(1.2 BUTADIENE)

1.2.3. Polybutadiene (BR)

Polybutadiene is also a widely used synthetic rubber, produced in a similar fashion to SBR. Polybutadiene can again exhibit three isomeric forms, cis, trans and vinyl.

These structures are shown in Figures 4-6.

The type of polymerization formed can be controlled by the use of other types of polymerization systems.

FIGURE 4

CIS 1.4. POLYBUTADIENE

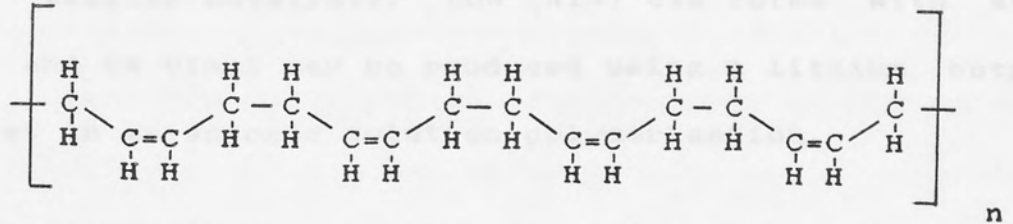

FIGURE 5

TRANS 1.4. POLYBUTADIENE

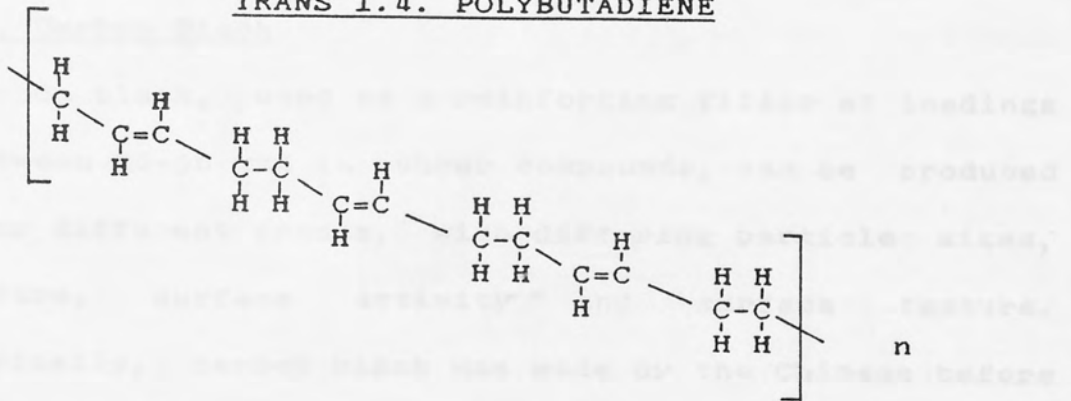
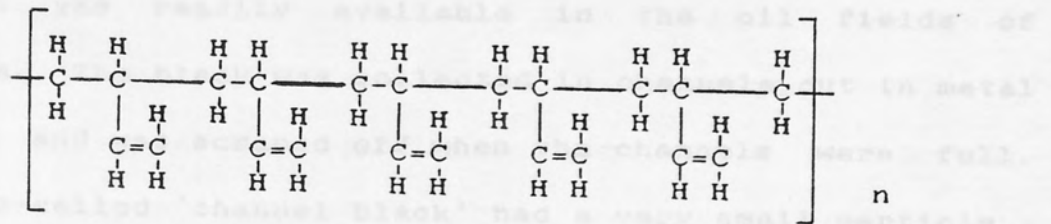

FIGURE 6

1.2. OR VINYL POLYBUTADIENE



The type of polybutadiene formed can be controlled by the use of other types of polymerisation systems.

High (97%) cis forms are produced using nickel or cobalt ziegler catalysts. Low (41%) cis forms with 49% trans and 6% vinyl may be produced using a lithium butyl catalyst in an anionic solution polymerisation.

Styrene-butadiene copolymers and polybutadiene are used in passenger car tyres where high wet grip, cornering forces and wear are required. Polymer contents in tyres vary from 40-60% of the rubber compound.

1.2.4. Carbon Black

Carbon black, used as a reinforcing filler at loadings of between 30-50 wt% in rubber compounds, can be produced in many different grades, with differing particle sizes, structure, surface activity and surface texture. Historically, carbon black was made by the Chinese before 3,000 B.C. by burning vegetable oil in small lamps with ceramic covers. This black was used as a pigment for ink and laquers. It was not until about 1912 that carbon black began to be used as a reinforcing agent for tyres.

(5) At this time the carbon black was made by burning natural gas readily available in the oil fields of America. The black was collected in channels cut in metal plates and was scraped off when the channels were full. This so-called 'channel black' had a very small particle size (below 35μ) and was acidic due to carboxylic acid

groups on the surface, which caused the curing properties to be slow.

The yield was poor and eventually the process was superceded by the invention of the oil furnace process in the early 1940s. The feedstocks used in this process are heavy, residual hydrocarbons that come from petroleum refineries. A flame is produced in a horizontal cylindrical furnace by burning gas with an excess of hot air. Into this flame, hot oil is atomised. A small portion of the oil burns with the excess air to sustain the flame temperature, but most of it is vapourised and cracked to form carbon black and hydrogen. The reaction temperatures are in the range 1,350 - 1,800°C and reaction times vary from a few milliseconds to a few seconds, depending on the grade of carbon black required. The downstream end of the reactor has water sprays for quenching the reaction.

Carbon black particle size growth is regulated by changing the temperature of the flame. Increasing the air to feedstock ratio, for example, produces a higher flame temperature, lower yield, and products with smaller particle size and higher surface area.

Before the carbon particles in the flame are quenched by the cooling water spray at the exit port of the reactor, they collide with each other and partially fuse together to form aggregates, which remain stable in size and shape upon cooling. The number of primary particles fused together to form each aggregate and the complexity of their three-dimensional arrangement

contribute to a property known as 'structure'. The 'structure' has a marked effect on performance in the finished tyre.

At the far end of the furnace, where the reaction is quenched with water, the newly formed carbon black aggregates are carried out in a gas stream that is still hot for further cooling. They are separated from the gas in large bag filters. The fluffy black is collected from the filters and densified by pelletisation for use in the tyre industry.

Attempts have been made to give a universal classification to carbon blacks by applying letters and numbers to each type. A prefix letter of 'N' for normal surface activity and 'S' indicating slow surface activity, are used. One of these letters is then followed by a digit 1 to 9 which indicates the black's particle size measured in nanometres. A second and third digit are also used but currently these are arbitrary. Hence a black with a small particle size may be designated N220, while a black with a large particle size would be N660.

1.2.5 Resins

Resins are used in tyre compounds either to give 'tack' to the compound or to reinforce the cross-linked material to impart stiffness. Tackifying resins are either straight chain, fully saturated hydrocarbons such as polymerised diolefins obtained from the cracking of oils

or ring structures such as abietic acid (wood rosin) obtained from trees.

Reinforcing resins are usually phenol derivatives such as octyl-phenol ($4-C_8H_{17}C_6H_4OH$), polymerised into short chains using acid catalysts. Further chain growth is carried out in the rubber compound during moulding using a formaldehyde donor such as hexamethyl methoxymelamine.

1.2.6. Antidegradants

Antidegradants are materials which, when added to rubber compounds in small amounts, retard the interaction of the polymers with atmospheric oxygen and ozone. Natural and synthetic polymers autoxidise on exposure to air, by reacting with molecular oxygen and ozone. The resulting chemical changes often impart undesirable properties, such as cracking and fatigue, eventually making the product unfit for use.

The general course of autoxidation can usually be divided into four successive stages according to the rate of reaction of the compound with oxygen.

- i) The initial period of negligible rate
- ii) The period of accelerating rate
- iii) The period of nearly constant rate
- iv) The final period of declining rate

The duration of the first stage plus the slow portion of the second is called the induction period and without antidegradants is likely to be very short.

Then:-

1) Initiation

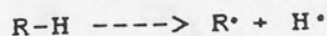

ii) Propagation

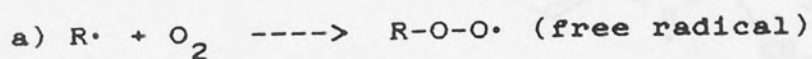

iii) Termination

By elimination of $R\cdot$ and $R-O-O\cdot$

Let $R-H$ be part of the rubber chain, where H is the hydrogen atom of a weak covalent bond.

The first reaction can be initiated by thermally excited molecules, metal catalysts or light.

Antidegradants prolong the induction period by reacting with free radicals from all sources and hence retard the oxidative deterioration of the product. The antidegradants in turn become free radicals, of lower energy and eventually stable compounds.

Examples of how antidegradants can react with a free radical are:-

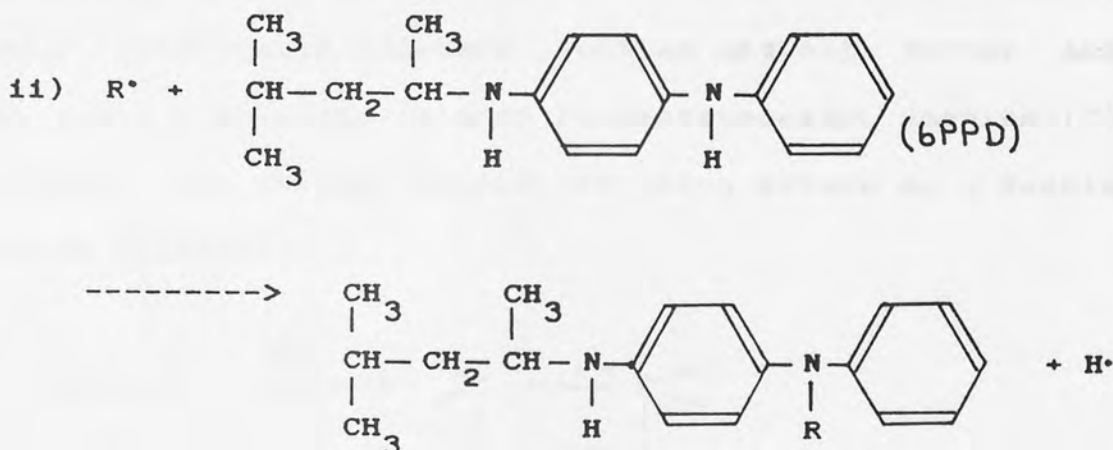
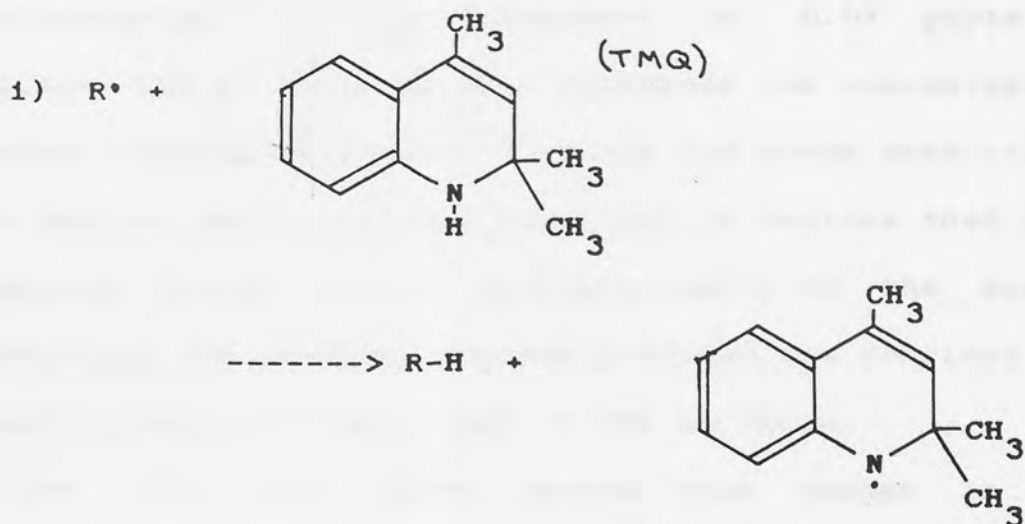

In the first case, the antidegradant donates a labile hydrogen atom and in the second it absorbs the free radical from the rubber and liberates a proton. Nearly all the highly efficient antidegradants are organic compounds, such as aromatic amines or phenols, which are capable of donating hydrogen atoms and forming free radicals which do not propagate chain reactions. For a given system, the increase in induction period tends to be directly proportional to the concentration of a particular antidegradant.

One of the most remarkable forms of rubber deterioration is ozone cracking. The average ozone concentration in the atmosphere is 0.04 parts per million, but in spite of this extremely low concentration, severe cracking of stretched rubber can occur over only a few months. Newton (6) was the first to realise that ozone cracking always occurs at right angles to the applied stress and the chemical changes produced are confined to a layer probably not more than 0.001 mm thick.

The fact that ozone reacts with rubber is not surprising as it will attack even saturated paraffins. Highly unsaturated polymers, such as natural rubber and SBR, react with ozone almost instantaneously. Harries (7) pictured the initial product of ozone attack on a double bond as follows:

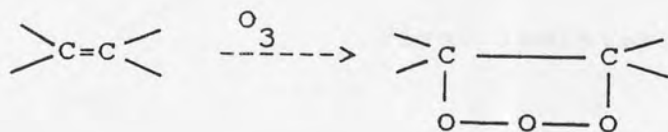

However, Staudinger's (8) formula:

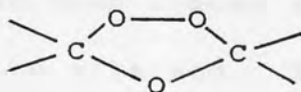

is now generally accepted as being more in accord with the hydrolysis and decomposition products of ozonides.

This structure poses some problems of mechanism, present also in the reaction of simple olefins.

1) The carbon-carbon bond must be broken without the molecule falling into two pieces.

ii) The ozone molecule is also severed.

The most likely mechanism for ozone attack is shown below.

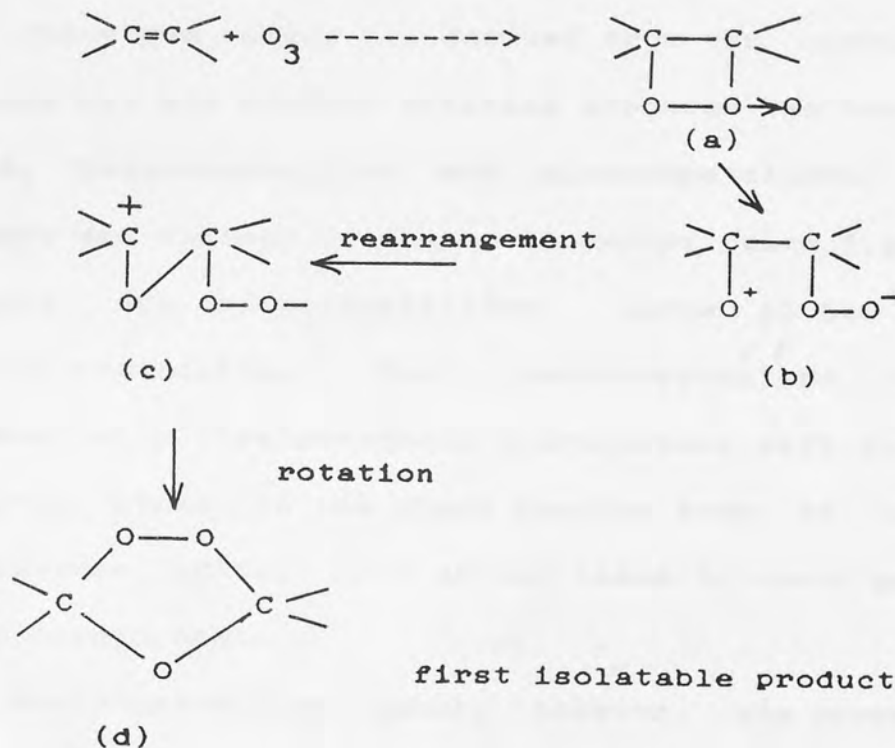

The problem of ozone cracking is evidently one of surface chemistry. The ozonide film is probably impermeable to ozone but because of its brittleness will crack on stretching and thus expose a fresh rubber surface which in turn will be attacked. Since the stress is concentrated at the tip of cracks, a crack once initiated will continue to grow.

The usual method of attempting to overcome ozone cracking in tyres is to add petroleum wax to the rubber compound. These waxes consist of a wide range of molecular

weights and gradually bloom to the rubber surface during the life of the product. This wax film prevents ozone from attacking the rubber surface under it, but is only a delaying system rather than a complete answer to the problem.

Petroleum waxes are derived from the distillation of crude oil and further refining produces two basic types of wax, macrocrystalline and microcrystalline. These two types are defined by their viscosity; below 5.5cS at 100°C waxes are macrocrystalline, above 10.5cS at 100°C microcrystalline. The macrocrystalline waxes are essentially straight-chain hydrocarbons with the number of carbon atoms in the chain ranging from 20 to 40. The structure of this type of wax leads to crack growth along the carbon chain.

Microcrystalline waxes, however, are branched chain hydrocarbons of much higher molecular weight. Their structures are such that crack growth is considerably reduced.

Paraffin waxes also carry out another important role. The chemical antidegradants added to the rubber compound dissolve in the wax and are carried up to the surface of the tyre as the wax blooms. Waxes, in general, are good at providing static protection, but under dynamic flexing conditions the wax film is broken allowing ozone to attack the rubber giving cracks. Chemical antiozonants are

usually paraphenylene diamine derivatives and are designed to offer protection under dynamic conditions.

A selection of antidegradants in current use would include:-

N.N. ditolyl paraphenylene diamine

N.N. diphenyl paraphenylene diamine

dimethyl acridone (a diphenylamine/acetone product)

polymerised 1.2. dihydro 2.2.4. trimethyl quinoline

1.2.7. Curative System

The system used to vulcanise rubber compounds consists, in general, of a metal oxide, a fatty acid, sulphur and an organic accelerator. The metal oxide is normally zinc oxide but oxides of magnesium or cobalt can be used in special applications. The fatty acid is normally commercial stearic acid which contains about 50 to 60% stearic ($C_{17}H_{35}COOH$), with the remainder consisting of saturated acids (lauric, palmitic, myristic) and small quantities of an unsaturated acid such as oleic.

The particle size of the sulphur is critical in order to give a good dispersion when it is used in a master batch form. The addition of a light petroleum oil to the powder prior to mixing into rubber improves the dispersion.

An allotropic form of sulphur, known as amorphous or "mu", can be produced which is insoluble in carbon

disulphide or other solvents. It is also insoluble in rubber and is used to control or prevent "blooming" of sulphur from unvulcanised compounds. This form of sulphur is unstable and tends to revert to the soluble, rhombic, form if heated. Little reversion takes place at 60°C, but progressively increases as the temperature is raised to the melting point when all the sulphur reverts to the soluble form. The insoluble form of sulphur is used where high loadings of sulphur (above 1%) are required in the rubber compound.

Since 1921 a large number of organic accelerators have been developed for all present day polymers. They can be divided into slow, medium, fast, ultra-fast and delayed action accelerators. From the vast number of organic accelerators available, those normally used for tyre compounds are selected from the following:-

a) diphenyl guanidine (DPG)

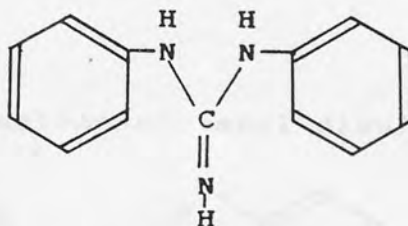

This is a safe, slow curing accelerator, developing high or low modulus depending on the amount used. Generally used as an activator for the thiazole accelerators.

2) Tetramethyl thiuram disulphide (TMT)

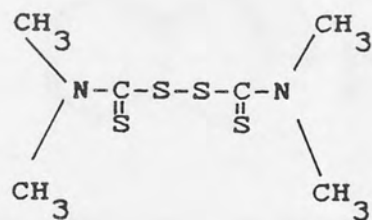

This is a fast accelerator when used in combination with sulphur, requiring zinc oxide for activation, but not stearic acid. It can be used alone, but is normally used as a secondary accelerator to activate thiazoles or sulphenamides.

3) 2-mercapto benzthiazole (MBT)

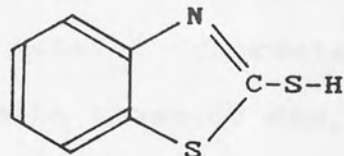

This is a medium speed accelerator of very wide application. It needs zinc oxide and stearic acid for activation.

4) mercaptobenzthiazyl disulphide (MBTS)

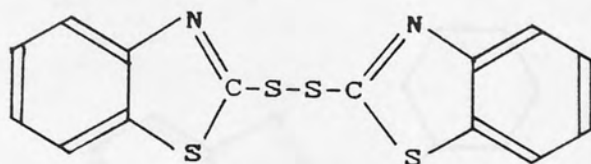

Similar to MBT in properties, but less active in the range 100 to 130°C. It has a certain degree of delayed action.

5) N-cyclohexyl-2-benzothiazyl sulphenamide (CBS)

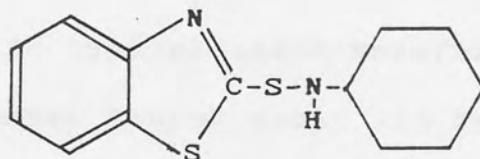

A delayed action accelerator of particular use with furnace blacks, which develops high resilience rubber compounds.

6) 2-(4-morpholinyl mercapto) benzthiazole (MBS)

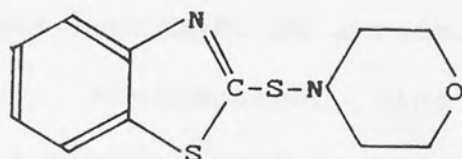

The general characteristics of this accelerator closely resemble those of CBS, but MBS gives better scorch resistance when used alone. When used at the same weight percent and equivalent cure temperatures, MBS cures significantly more slowly than CBS.

7) N,N-dicyclohexyl-2-benzthiazyl sulphenamide (DCBS)

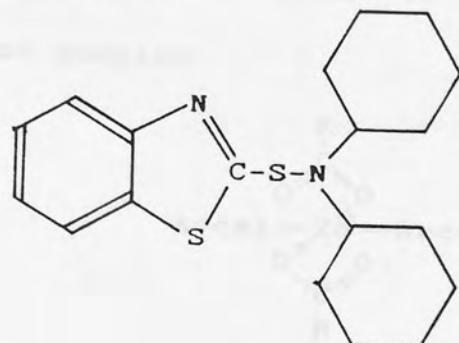

DCBS has the best scorch resistance of the sulphenamide accelerators. Under comparable conditions of processing in typical black-reinforced rubber compounds it shows a Mooney Scorch about 75% better than MBS and about 100% better than CBS. DCBS does, however, produce a markedly slower cure than MBS or CBS at equal dosage and it is not normally practicable to compensate fully for this by increasing the dosage.

1.3. Literature Survey

1.3.1. Vulcanisation Mechanisms

The basic reactants in a rubber compound are assumed to be sulphur, accelerator, zinc oxide, fatty acid and rubber. A simplified scheme for vulcanisation was postulated by Bateman et al (9), and is as follows:-

1. The reaction of the accelerator with zinc ions readily forms a zinc complex which is assumed to be a chelated structure.

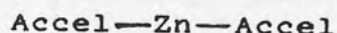

2. Through the action of fatty acids, oxygen containing ligands bond to the zinc atom of the accelerator complex.

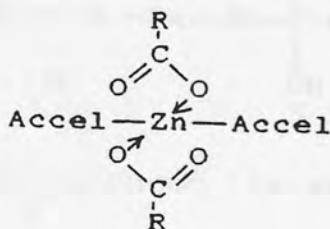

where R = C₁₇H₃₅

3. Nucleophilic attack on the S_8 ring, results in its scission and the insertion of sulphur into the complex. This zinc complex containing sulphur, accelerator, and fatty acid, was believed to be the actual sulphurating agent.

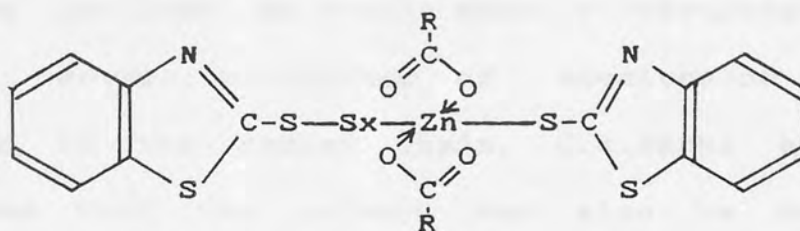

4. In the presence of rubber, attack on an alpha-methyl or alpha-methylenic carbon atom relative to the double bond, results in the removal of a proton and pendant sulphur/accelerator groups being attached to the rubber chain.

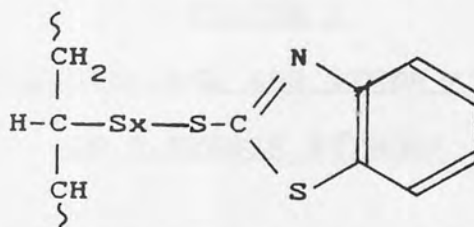

5. Crosslinking may take place when one sulphurated chain reacts with another. This was thought to be a disproportionation process, involving interchange of S-S bonds and catalysed by accelerator ions derived from the zinc-accelerator complex.

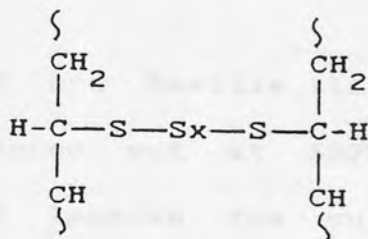

where $\sim\text{CH}_2-\underset{\text{H}}{\text{C}}-\text{CH}\sim$ is part of a polymer chain

The sulphur at this stage, is an S_8 linear chain which is unstable and further heating breaks down the chain into shorter fragments which form additional crosslinks in the polymer/sulphur network. Crosslinks may be mono-, di-, or polysulphidic, the site of the sulphur attachment generally being at an allylic carbon atom. Sulphur may also be included as cyclic mono or disulphides and as pendent groups consisting of accelerator fragments attached to the rubber chain. C.R.Parks et al (10) suggested that the network may also be modified by conjugated dienes or trienes along the rubber chain.

The main types of crosslinks and other attachments are shown below in Figure 7.

FIGURE 7
TYPES OF CROSSLINKS AND OTHER ATTACHMENTS
IN A RUBBER NETWORK

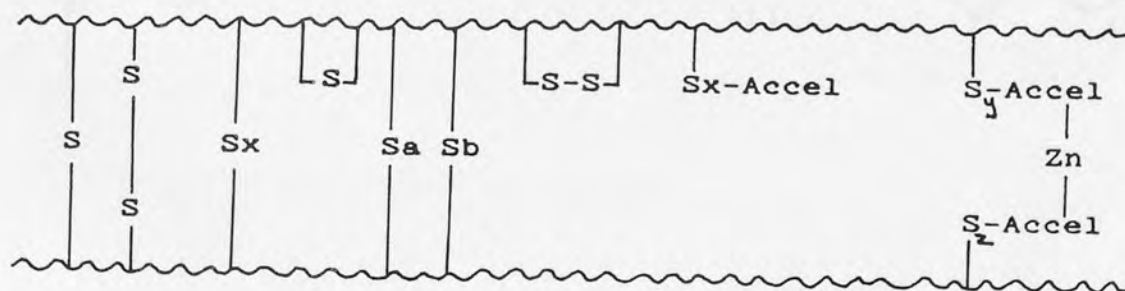

Allen, Barnard and Saville (11) have summarised the early work carried out at NRPR which attempted to understand and improve the vulcanisation of natural rubber. The initial work involved the use of an

empirically developed mixture using mercapto benzthiazole as accelerator. This was heated for some tens of minutes at 140°C . However, the analysis of such mixtures with natural rubber was virtually impossible and Farmer and Bloomfield (12) decided to simplify the problem.

They concentrated on a study of the reactions of sulphur with simple alkenes (e.g. 2-methyl pent-2-ene), which could be considered as corresponding to 'one-unit' of cis 1.4-polyisoprene. These studies revealed that the reaction products were mainly organic polysulphides (RS_xR^1), in which one group (R) was a fully saturated alkyl group while the other (R^1) was a substituted allyl group.

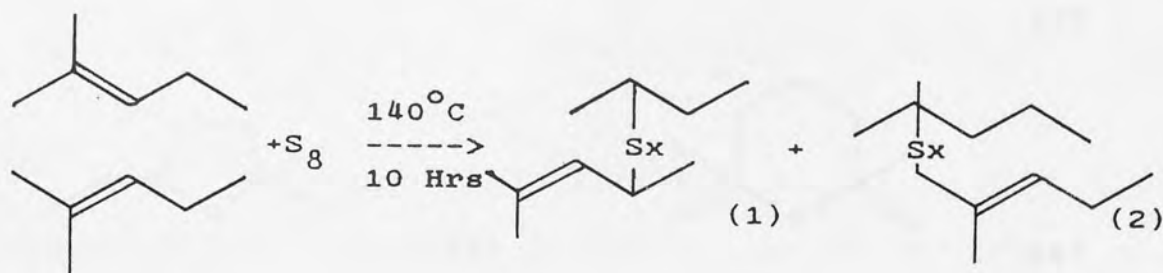

However, this simplicity was short lived as rubber is not a mono-ene, so the next step was to sulphurate a two or three unit alkenic model. They chose dihydromyrcene (trans-2,6-dimethylocta-2,6-diene.3) as a model compound and found that on thermal sulphuration this gave not only crosslinked structures akin to those above :-

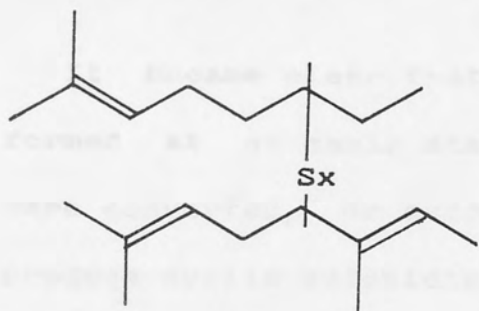

(3)

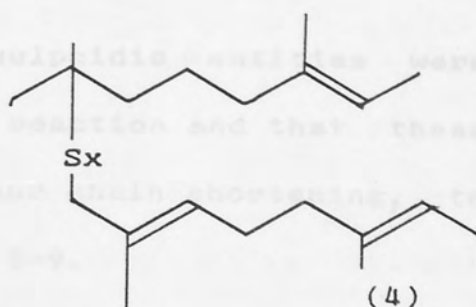

(4)

but also:-

conjugated trienes

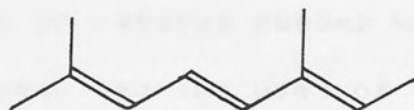

(5)

cyclic sulphides

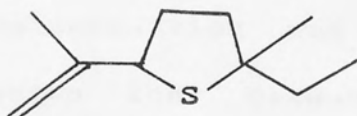

(6)

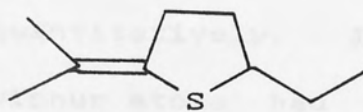

(7)

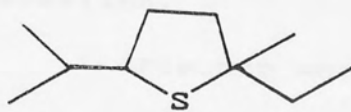

(8)

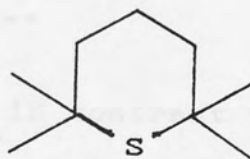

(9)

and vicinal crosslinked structures

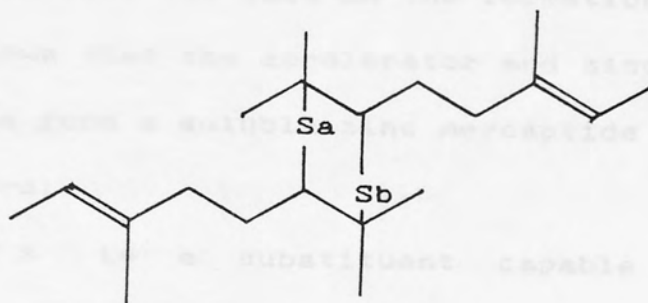

(10)

It became clear that the polysulphidic entities were formed at an early stage in the reaction and that these were converted, or suffered sulphur chain shortening, to produce cyclic sulphidics such as 5-9.

It was then shown by Moore et al, in studies on the structural characterisation of vulcanisates (13-21), that the reactions taking place in model compounds occurred also in the vulcanisation of natural rubber with sulphur. The key to this approach was the use of refined physical methods to determine the concentration of crosslinks introduced into the rubber network during vulcanisation. The suspected inefficiency of straightforward sulphur vulcanisation was demonstrated quantitatively. It was shown that between 40 and 100 sulphur atoms had to be combined somewhere in the network to produce one crosslink.

Further work showed that in contrast to the simple rubber-sulphur system of Goodyear's discovery (22), the modern organic accelerators and activators, greatly minimised the extent of main chain modification and most of the sulphur was used in the formation of crosslinks. It was shown that the accelerator and zinc oxide/fatty acid or amine form a soluble zinc mercaptide species $(XS)_2ZnL_2$ (1) where:-

X is a substituent capable of considerable electron withdrawal properties

and

L, (formally RCO_2^- or an amine), is a ligand which serves to render the complex soluble in the rubber compound. (1) interacts with molecular sulphur to form a sulphurating agent (2) which can replace an allylic hydrogen of the rubber, by a sulphur chain bearing an accelerator moiety eg (3).

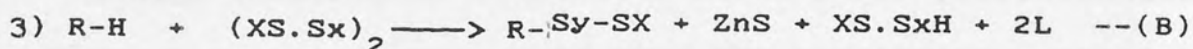
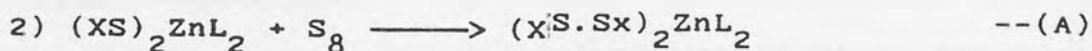

Compounds of type B are rapidly converted into bisubstituted allyl polysulphides, the initial crosslinks, that then undergo further transformations of technical importance, as shown below:-

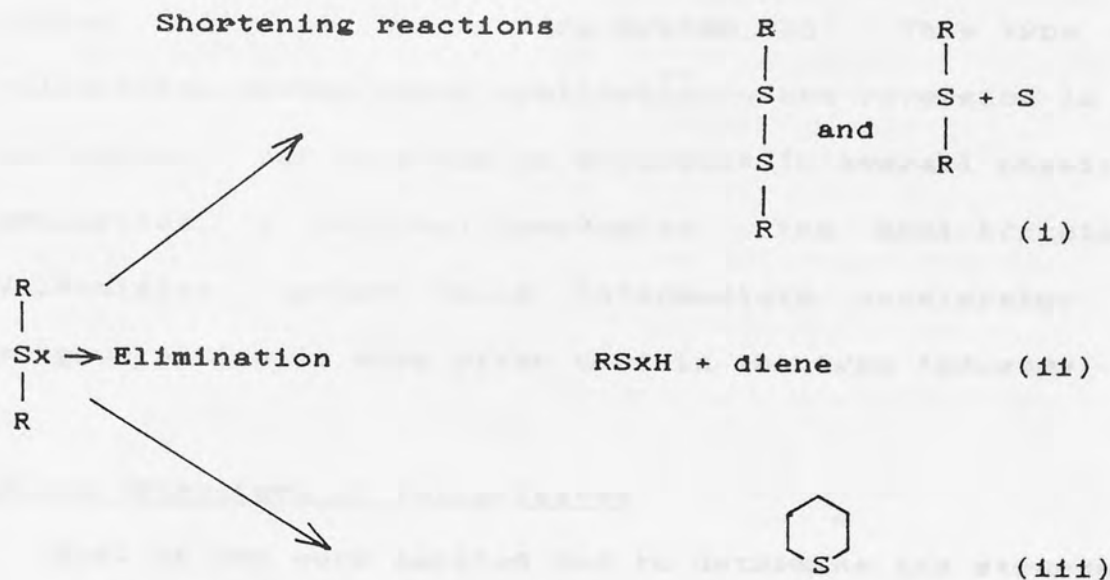

Cyclic sulphide formation with shortening of RS_xR and/or crosslink destruction

Routes (ii) and (iii) result in loss of crosslinks and constitute reversion.

The normal vulcanisation recipes using low accelerator to sulphur ratios, yield polysulphide crosslinks that are resistant to the shortening reaction (i). The resultant vulcanisate has the excellent physical properties of a polysulphidic network, but can undergo detrimental reversion on overcure or in service under conditions of high temperature.

A high accelerator to sulphur ratio gives polysulphides where R is of such a nature that the shortening reaction (i) is rapid and catalysed by the high concentration of the accelerator.

Thus, (i) predominates over (ii) and (iii) and almost all the sulphur is channelled into the efficient formation of thermally stable monosulphidic crosslinks - the so-called Efficient Vulcanising System (23). This type of vulcanising system finds application where reversion is to be avoided, but they can be deficient in overall physical properties. A rational compromise - the Semi-Efficient Vulcanising system using intermediate accelerator to sulphur ratios is more often used in the tyre industry.

1.3.2. Structure of Vulcanisates

Most of the work carried out to determine the structure of vulcanisates has involved the use of crosslink density measurements. Saville and Watson (24), reviewed the use of radioactive sulphur to determine polysulphide linkages by sulphur exchange mechanisms. They also examined the use

of 'chemical probes' such as lithium aluminium hydride, triphenyl phosphine and trialkyl phosphites. The early work using stress/strain data to arrive at network chain density, led to swelling measurements in toluene and the use of more specific chemical probes, as shown in Table 1. The crosslink density of a network can be determined using the Mooney-Rivlin equation (25) to determine the Elastic Constant and substituting this value into the Flory-Rehner equation (26).

TABLE 1
CHEMICAL REAGENTS FOR CLEAVING DIFFERENT TYPES OF
SULPHIDES

<u>REAGENT</u>	<u>REACTION</u>
Propane-2-thiol/piperidine in n-heptane	Polysulphides are cleaved with di- and monosulphides remaining intact.
n-hexanethiol/piperidine	Both polysulphides and disulphides cleaved, leaving monosulphides unreacted.

The use of these probes was developed by Campbell and Saville (27) and reviewed in a paper by Kuan(28).

Lautenschlaeger (29-32) described a relatively fast method for model compound vulcanisation (MCV) experiments. The technique consisted of heating the model compound, with the vulcanisation system, in a glass tube for predetermined times and temperatures. The reaction products were examined using gas chromatography and mass spectrometric techniques. This approach obtained information on the effect of processing variables on the distribution of sulphide products in a reasonably short time. The results obtained from MCV are generally consistent with results from the actual vulcanisation of natural rubber.

An example of Lautenschlaeger's results is illustrated in Table 2.

TABLE 2
PERCENT SULPHUR CROSSLINKS FOR MODEL COMPOUNDS
OF DIFFERENT SULPHUR/ACCELERATOR RATIOS

SULPHUR	CBS	TEMP °C	CURE TIME (MIN)	% S CROSSLINKS		
				POLY-	DI-	MONO
3.0	0.6	135	50	34	33	32
1.4	2.2	135	50	7	28	60
0.6	9.0	135	50	2	8	90

Formulation used:-

2-methyl-2-pentene	25g
Stearic Acid	3g
Zinc Oxide	5g
Flexone 7L	3g
CBS	Various
Sulphur	Various

Moore and Trego (33,34) introduced the concept of crosslink efficiency by combining both molecular and microphysical information to obtain two crosslink efficiencies, E and E^1 . E refers to the number of gram atoms of combined sulphur per gram molecule of chemical crosslinks formed in the network. E^1 refers to the number of gram atoms of sulphur remaining in the network per chemical crosslink originally present, after treatment with triphenyl-phosphine, which converts dialkenyl di and polysulphides to monosulphides. It was claimed that the complexity of a crosslinked rubber was completely defined from the precise knowledge of these two parameters. High values of E and E^1 denoted a fairly complex network with a preponderance of polysulphide crosslinks and extensive main chain modifications.

A summary of results showing the various types of crosslinks is given in Figure 8. The results are reproduced from the work of Skinner(35).

FIGURE 8

STRUCTURAL CHARACTERIZATION OF NR VULCANISATES

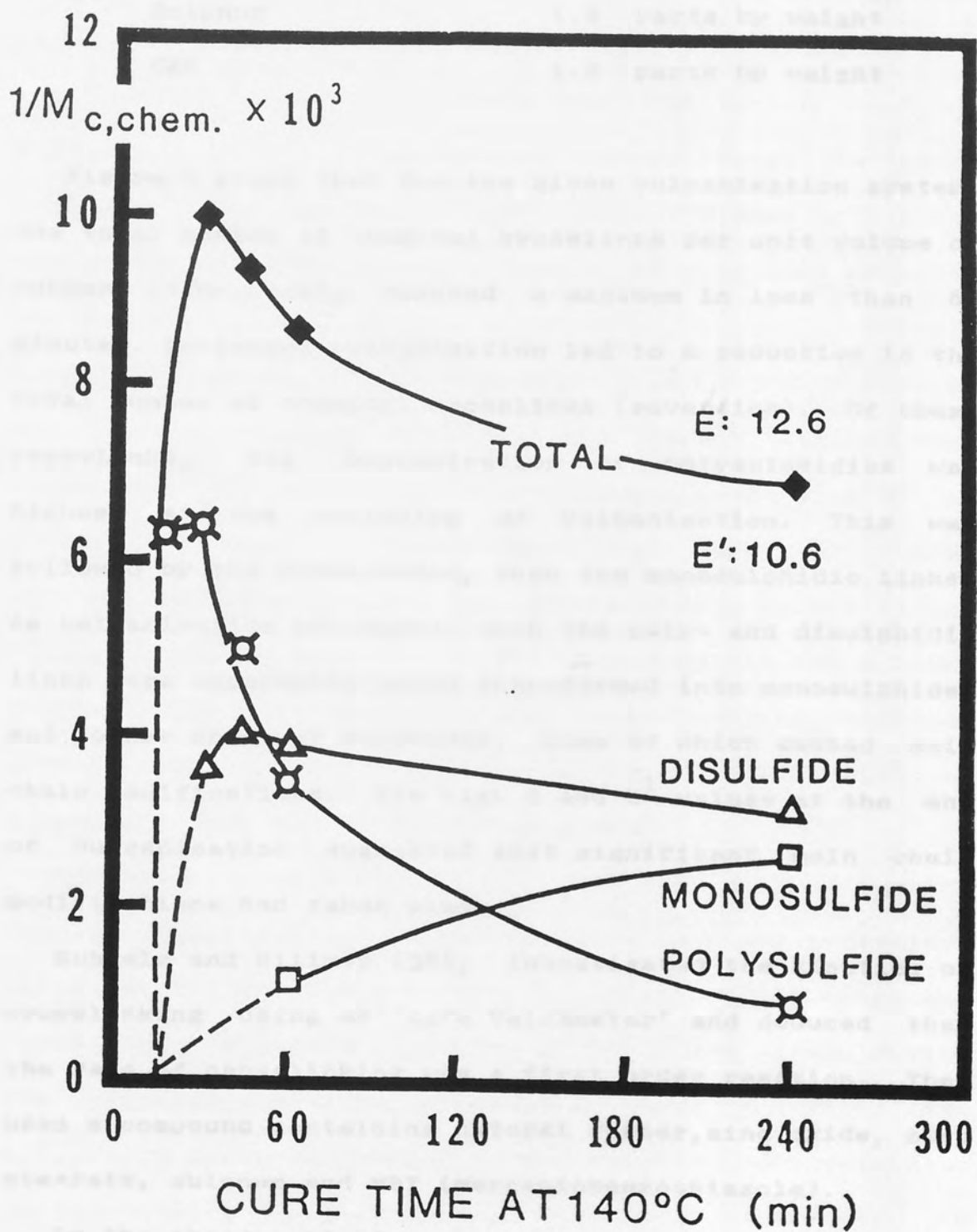

The compound consisted of:-

Natural Rubber	100	parts by weight
Zinc Oxide	3	parts by weight
Lauric acid	1.4	parts by weight
Sulphur	1.8	parts by weight
CBS	1.0	parts by weight

Figure 8 shows that for the given vulcanisation system, the total number of chemical crosslinks per unit volume of rubber ($1/Mc,chem$), reached a maximum in less than 60 minutes. Prolonged vulcanisation led to a reduction in the total number of chemical crosslinks (reversion). Of these crosslinks, the concentration of polysulphidics was highest at the beginning of vulcanisation. This was followed by the disulphidic, then the monosulphidic links. As vulcanisation proceeded, both the poly- and disulphidic links were apparently being transformed into monosulphides and other forms of sulphides, some of which caused main chain modifications. The high E and E^1 values at the end of vulcanisation suggested that significant main chain modifications had taken place.

Scheele and Hillmer (36), investigated the kinetics of crosslinking using an 'Agfa Vulcameter' and deduced that the rate of crosslinking was a first order reaction. They used a compound containing natural rubber, zinc oxide, zinc stearate, sulphur and MBT (mercaptobenzothiazole).

In the absence of zinc stearate, the rate at which the sulphur disappeared was independent of the amount of ZnMBT

formed, where ZnMBT is the actual accelerator. The activation energy of the sulphur diminution was found to be 28-30 kcal/mole (37).

In the presence of zinc stearate (38), a rise in the degree of crosslinking is brought about, together with a considerable increase in the rate at which sulphur disappears and the activation energy drops to 19-20 kcal/mole. Gee and Morell (39), found the same activation energy in MBT accelerated vulcanisates when zinc stearate was present.

Anfimova et al (40) examined the sulphur vulcanisation of isoprene rubbers containing HAF carbon black. They found that the adsorption and catalytic properties of the filler gave rise to the formation of a layer of rubber with a high crosslink density at the surface of the filler particles while the rest of the rubber matrix had a lower degree of crosslinking than in a corresponding unfilled rubber vulcanisate. The effect was greater with an increase in the amount of carbon black.

Several investigators (41-43) of the delayed action sulphur vulcanisation of rubbers have proposed mechanisms which postulate that a number of intermediate compounds containing fragments of the accelerator are formed during the vulcanisation cycle. Although a number of workers (44-48), have measured changes in the sulphur and accelerator levels during vulcanisation, none have identified and determined the intermediate products which appear to be

formed.

Campbell and Wise (49,50), examined natural rubber, vulcanised with a range of accelerators, in an attempt to identify the types of intermediates by ultra-violet spectroscopy and polarography and they concluded that MBT was formed from sulphenamide accelerators during the cure cycle. The original accelerator used disappeared during the delay period of the cure and it was concluded that it may not exist at all when crosslinking began. An intermediate of accelerator plus sulphur increased to a maximum concentration after some 48 minutes at 130°C, just prior to crosslinking, then underwent a rapid decrease at the onset of crosslinking.

This intermediate material was suggested to be a 2-(4-morpholinopolythio)benzothiazole derivative and the average sulphur concentration was estimated by polarography and ultra-violet spectroscopy to be approximately 1.5 additional sulphur atoms for each benzothiazole moiety, i.e.,

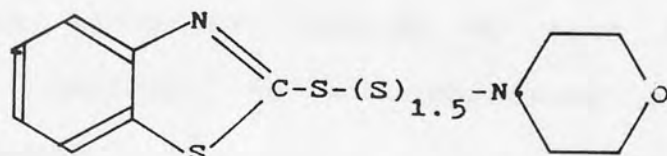

Undoubtedly a mixture of derivatives consisting of various whole integers of sulphur was present.

Coran, (51-55) dealt with the characterisation of rubber networks, using thin films and infrared

spectroscopy; the affects of compounding variables on the nature of such networks and the kinetics of sulphur vulcanisation were investigated. The total crosslink density was found to be a linear function of the square root of the product of the sulphur and sulphenamide accelerator concentrations, with a limited amount of variation due to changes in the stearic acid amount. He assumed that Russell et al, (56) were correct in stating that crosslink formation was a first order reaction and introduced various theories to explain the delay in the onset of vulcanisation when using sulphenamide accelerators.

The suggested scheme was:-

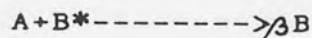
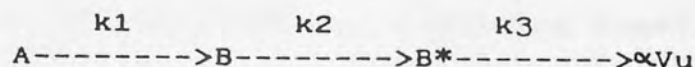

where A is the accelerator and/or its reaction products (with sulphur, zinc.etc); B is a precursor to crosslinks; B* is an activated form of B, such as a polymeric polythiol radical; Vu is a crosslink; and α and β adjust stoichiometry.

If the reaction through k_4 is much faster than through k_3 , very little crosslink formation can occur until A is essentially depleted. Both the reaction through k_3 and that through k_4 are assumed to be much faster than the reaction through k_2 . Hence, after the delay required for

the depletion of A, crosslink formation will proceed in a first order fashion.

Studebaker (57) showed that only polysulphidic links are formed with 1,3-diphenylguanidine as accelerator. With thiazole acceleration, polysulphides appear to be the first type of crosslink formed, but after the initial stages of cure, monosulphide formation can quite often be observed. Monosulphide formation is augmented by an increased accelerator concentration and by equimolar increases in zinc oxide and stearic acid. (58)

Several workers have attempted to determine the exact nature of the vulcanisation process and the intermediates formed. It is generally accepted that the zinc oxide and stearic acid are activators, combining together to form a complex with the accelerator. This complex is responsible for opening up the eight membered sulphur ring, releasing the sulphur chain in a form whereby it can generate crosslinks with the polymer chain.

One possible structure for the complex between accelerator, zinc oxide and stearic acid is that proposed by Campbell and Wise (49), which is shown on Page 50.

The complex could react with S_8 to give a molecule containing a thiazole group at each end of an S_8 chain, with the release of stearic acid and zinc oxide or perhaps, zinc stearate. During the initial formation of the complex an amine would then be liberated from the sulphenamide accelerator.

The proposed structure for the complex between zinc oxide, sulphur, accelerator and stearic acid by Campbell and Wise is:-

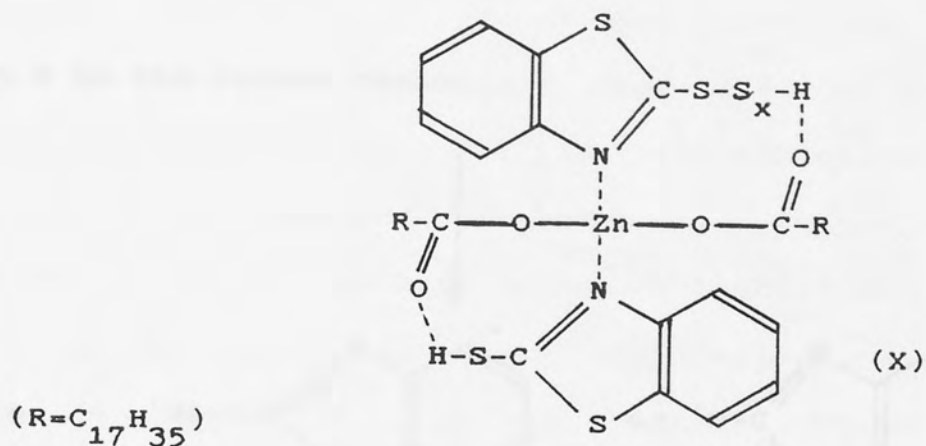

The elimination of the amine from the accelerator in the production of such a structure leads to one area of investigation to be demonstrated later in this thesis.

The subsequent breakdown of such a complex shown above could lead to the following pathway to crosslinks:-

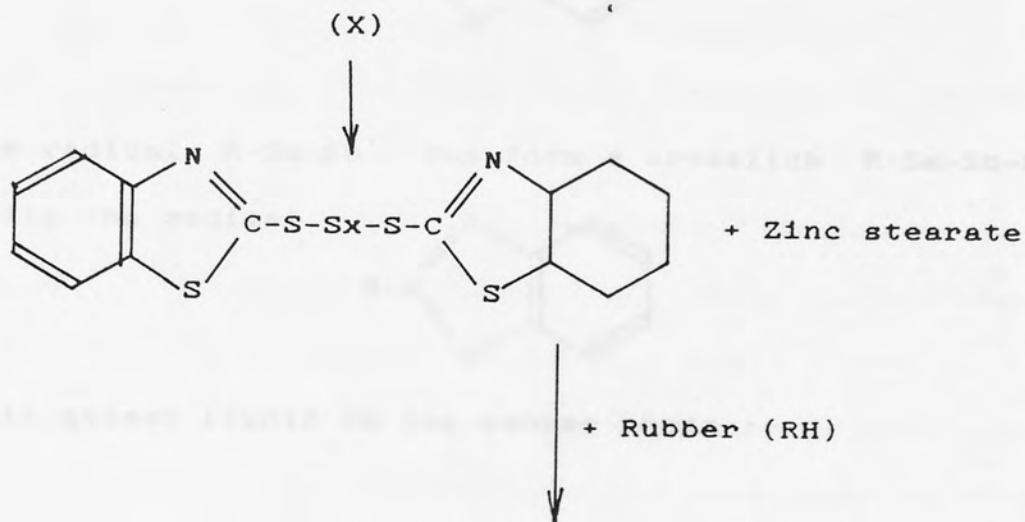

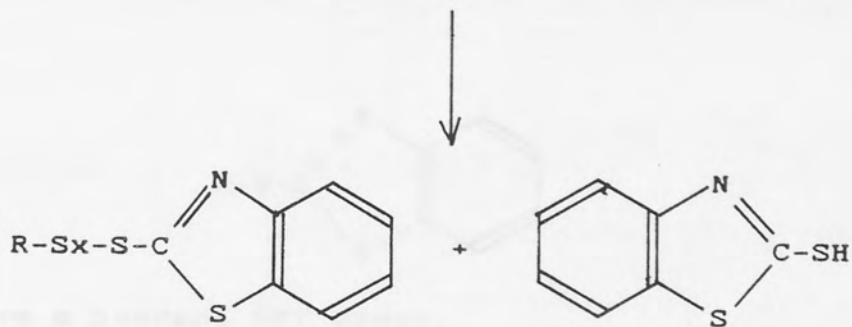

where R is the rubber chain.

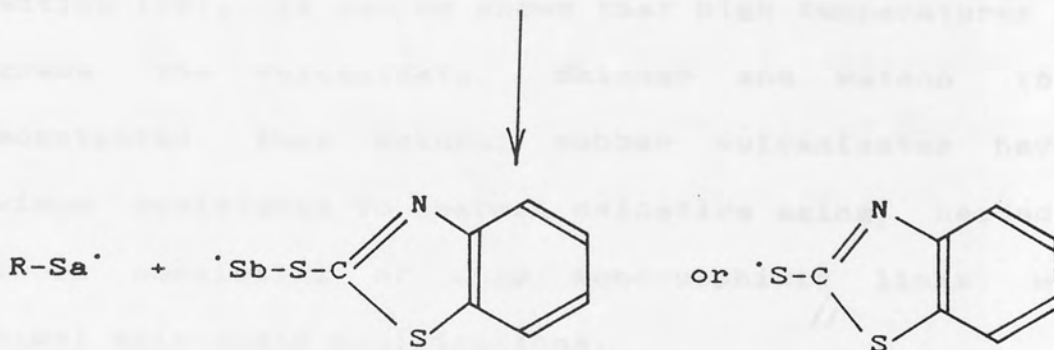

and R-Sa-Sb^\cdot

Where Sa and Sb are parts of the S_8 chain.

This gives a crosslink:- R-Sa-R and a further crosslink precursor:-

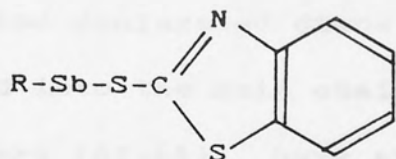

The radical R-Sa-Sb^\cdot can form a crosslink R-Sa-Sb-R ,

while the radical

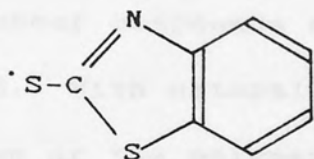

will attach itself to the rubber chain :-

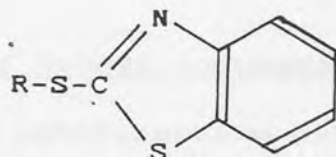

to give a pendant MBT group.

Having developed the crosslinked structure to an optimum level, and determined the kinetics of the reaction (59), it can be shown that high temperatures can degrade the vulcanisate. Skinner and Watson (60), demonstrated that natural rubber vulcanisates having maximum resistance to thermal oxidative aging, needed a network consisting of only monosulphidic links with minimal main-chain modifications.

However, Colclough et al. (61), oxidised natural rubber vulcanisates containing only monosulphidic links, with oxygen and tert-butyl hydroperoxide. When these samples were heated at 75°C the monosulphidic links were broken and crosslinks containing two sulphur atoms were formed. At the same time conjugated diene and triene structures were introduced into the main chains.

Other workers (62-64), have shown similar effects and have offered systems using silyl compounds to reduce the thermal aging process.

Most modern rubber compounds show oxidative thermal aging if overcured. With natural rubber compounds, the oxidative breakdown of the polymer chain shows a linear relationship with time at a constant temperature and this effect can be used to determine the heat input of tyres in service.

1.4. Analysis of Rubber Compounds

The earliest comprehensive publication on the analysis of rubber compounds is the 'Analysis of Rubber' by J.Tuttle in 1922 (65). In 1958, the ASTM methods for the analysis of rubber were published (66), but had been preceded by the British Standard Methods published in Europe in 1950 (67). These British Standards are supplemented by W.C.Wake's book 'Analysis of Rubber and Rubber-like Substances', first published in 1958 but now in its third edition (68).

These early publications, still in print but updated many times, gave methods for the analysis of the amount of polymer, carbon black, activators such as zinc oxide and magnesium oxide, oils, softeners and sulphur. The advent of synthetic polymers brought about techniques such as pyrolysis gas chromatography and pyrolysis infrared spectroscopy. The increasing numbers of accelerators and antidegradants has led to a multitude of analytical methods. Some of these specialised techniques will be discussed in the following sections.

1.4.1. Thin Layer and Spectroscopic Methods

In 1951, K.E.Kress (69), described the quantitative determination of accelerators in masterbatches, using ultra-violet spectroscopy. The accelerators examined were thiazoles, thiuram disulphides and guanidines. The same accelerators were identified using Thin Layer Chromatography by R.Gaczynski and M.Stepien (70) in 1961.

By 1962, sulphenamide accelerators were manufactured and Lloyd and Hawkes (71), described a technique for their identification from rubber compounds using spectral difference from an ultra-violet spectrophotometer. A solvent extract from a rubber stock was placed both in the reference and sample beam of the spectrophotometer. By adding small quantities of reagents to the sample cell, difference spectra were obtained showing shifts in the absorbance maxima of the accelerators.

Auler (72), gave a comprehensive review of the analytical methods available in 1961 for the determination of accelerators and antioxidants. At that time the techniques included paper chromatography, infrared and ultraviolet spectroscopy and polarography.

Higgins and McSweeney described a method for the identification of sulphenamide accelerators by Thin Layer Chromatography. (73) The vulcanisate was heated with sodium bicarbonate solution and a solution of 4-chloro-7-nitrobenzo-2.1.3.-oxydiazole (NBD-Cl), to form fluorescent derivatives with the amines liberated during the breakdown of the accelerator. After spotting the solution onto the plate, it was eluted with a toluene/ethyl acetate solvent mixture and the eluted spots examined under ultraviolet light.

In 1983, Lussier, (74) presented a scheme for the isolation of different types of accelerators. A vulcanisate was extracted with a hydrochloric acid/methanol mixture. Subsequent extractions of acid and alkaline solutions isolated amines, thiazoles and guanidines, which were then identified by infrared and ultraviolet spectroscopy and gas chromatography.

Simpson, (75) used thin layer chromatography to identify antioxidants, ultraviolet absorbers, organotin compounds and lubricants in plastic materials. 2,6-dichloro-p-benzoquinone-4-chlorimine was used to develop the eluted spots and 15 different antioxidants were differentiated. Fatty acid esters were separated using reversed phase thin layer chromatography on silanised silica gel. Development was by iodine vapour and molybdophosphoric acid.

Protivova and Pospisil (76), extracted vulcanisates with polar solvents (eg. acetone, diethyl ether), then eluted the samples on silica gel UV₂₅₄ using benzene-hexane, benzene-diethyl ether and benzene-ethanol solvent mixtures. An acidic solution of potassium permanganate was used to visualise the spots. They were able to identify a wide range of paraphenylene diamine antidegradants.

A thin layer chromatography method developed by Nagasawa and Ohta, led to the identification of 24 accelerators and 19 antidegradants. (77) Samples were developed on silica gel plates with chloroform-benzene (10:9) in one direction and with ethanol in a perpendicular direction. The plate was sprayed with

formalin-sulphuric acid (1:4) then heated for one hour at 120°C.

1.4.2. High Pressure Liquid Chromatography

Several workers have used high pressure liquid chromatography (HPLC) mainly for the determination of antidegradants (78-81), but occasionally for analysis of accelerators. (82) Antidegradants were extracted from polymers using carbon tetrachloride or tetrahydrofuran. After the low molecular weight polymer had been precipitated with acetone, the remaining solution was evaporated to dryness then taken up in small quantities of THF. Separation was carried out using a Bondopak C₁₈ column, 60cm x 0.39cm id., with a mobile phase of methanol-water-THF in the ratio 67:7:30 and a flow rate of 2ml/min. Detection was by an ultraviolet spectrophotometer at 254nm. Calibration curves were constructed using known amounts of the additives and plotting peak areas against the concentration.

Systems for the prediction of retention indices of phenolic antidegradants have been suggested. For the prediction of retention data in a binary mobile phase, the change in the retention index with mobile phase composition can be described by the simple equation:

$$\log I = k + \log I_0$$

where k is the slope of the straight line and $\log I_0$ is the y intercept.

Graphs can be plotted of $\log I$ (retention time) against % methyl alcohol in the mobile phase, so that k and $\log I_0$ can be determined. The retention time of any particular antidegradant can then be predicted for any mixture of water/methanol when eluting through the same column as for the standards.

HPLC can be used to study the oxidation products of phenolic antidegradants. Gradient elution methods have shown that more than 20 thermal and photochemical transformation products can be separated.

In the determination of antidegradants extracted from vulcanisates, Blenkin demonstrated that the recovery was very poor. Recoveries of paraphenylene diamine types varied between 35% and 80%. It will be shown later that extraction of antidegradants from vulcanisates can give zero recovery, but that this does not mean that there is no antidegradant remaining in the rubber compound.

Work carried out at Monsanto, showed that mixtures of antidegradants and accelerators could be analysed using HPLC. The samples of rubber compounds did not, in the main, contain carbon black, so that the preparation of the sample for analysis was carried out by dissolving the compound then precipitating the polymer. Several binary mobile phases were used and were varied depending on the particular antidegradant/accelerator mixture involved.

1.4.3. Thermal Analysis Techniques

Manley (83), in an article on Thermal Methods of Analysis summarises the situation thus:-

'Differential thermal analysis, thermogravimetry and related techniques have been shown to be valuable in research on the morphology of polymers, the determination of first and second order transition points, identifying polymers, studying rates of cure, the study of reaction kinetics and in the effects of oxidation on rubbers and polymers. Thermal methods of analysis are particularly suitable for quality control. Differential thermal analysis provides a very rapid fingerprint for raw materials and in favourable circumstances thermogravimetry can, in a few minutes, provide a full analysis of a rubber compound including black and filler.'

Parameters such as glass transition points, melting points and degradation products can be found from differential thermal analysis. The measurement of weight losses in the presence of different gases (eg nitrogen and oxygen), gives information on the amount of polymer, carbon black and fillers in rubber compounds. Thermogravimetric Analysis has been reported by several workers (84-90).

1.4.4. Mass Spectrometry

Mass spectrometry is a fast and powerful method for the identification of materials. The most useful results can be obtained by analysing single, pure materials and as such this technique is usually combined with the separating power of gas chromatography. Pausch et al (91), carried out a series of experiments using pyrolysis mass spectrometry, where a sample of rubber compound was pyrolysed using Curie Point pyrolysis and the pyrolysate passed directly into the mass spectrometer. By using pattern recognition techniques, the resulting complex mass spectrum could be interpreted to identify various components. Polymer types, antidegradants and plasticisers were identified but more work was necessary to identify curatives and high molecular weight ions.

Mass spectrometric analysis of gases, given off from autoclave curing of a rubber compound, was described by Smith (92). He was particularly interested in the various types of solvents and resin systems used in the preparation of the polymer materials. The mass spectrum of the gas showed the presence of acetone and cyclopentadiene.

1.4.5. Gas Chromatography

Gas chromatography has been used in the rubber industry since the inception of the technique. Its first major use was in the identification of polymer systems used in rubber compounds. With the advent of the styrene-butadiene co-polymers in the 1950's, followed by polybutadiene,

butyl and a whole range of different polymers, it became necessary to have a method which could separate and identify the polymers when mixed together.

The work of Martin and Synge (93) in 1941, leading to the quantitative analysis of fatty acids by Martin and James (94) in 1952, gave birth to the technique of gas chromatography as it is known today.

External pyrolysis of the sample and injection of the pyrolysate into a chromatography column, was the first step in the analysis of polymer mixtures. Blenkin (95), developed the principle of on-column pyrolysis, which gave an immediate improvement in the analysis of polymer mixtures, as both monomers and dimers were introduced into the column.

Ney and Heath (96), showed that on analysing the pyrolysis products of the polymer mixture, the quantities of dipentene, styrene and vinyl cyclohexene produced could be used to calculate the ratio of the NR/SBR/BR polymer system.

Thompson, in a series of papers (97-100), described the work leading up to a fully automated, computerised, curie-point pyrolysis, gas chromatography method for the analysis of polymer blends in rubber compounds.

Patel et al (101), developed a method for the identification of sulphenamide, thiuram disulphides and dithiocarbamate accelerators in vulcanised rubber mixes. During vulcanisation, the breakdown products are amines,

carbon disulphide and mercaptobenzothiazole. The amines were converted into trifluoroacetamide derivatives, the MBT into a methyl thioether derivative and the carbon disulphide detected by the copper xanthate test.

The derivatives of the amines and MBT were analysed by gas chromatography and could be distinguished by their retention times. No attempt was made to make the method quantitative.

Antidegradants have also been analysed by gas chromatographic methods. Wise and Sullivan (102), determined the retention times of a series of para-phenylene diamines using Apiezon L as the stationary phase; analysis time was about 25 minutes. They noted that there was an apparent large loss of antidegradant due to the vulcanisation of the rubber compounds.

A review of analysis methods for rubber by Krishen (103), discussed the applications of gas chromatography and pyrolysis gas chromatography. Among the methods quoted were those for polymer identification, the degree of cross-linking in chloromethyl divinylbenzene, microstructural characterisation of ethylene propylene copolymers and the degree of chemical inversions for monomer units along the polymer chain of polypropylene.

1.4.6. Fourier Transform Infrared Spectroscopy

The presence of carbon black in rubber compounds tends to make any method of analysis using infrared transmission useless, because of the high attenuation of the beam.

Devlin (104), took microtomed sections of rubber compounds, 2 micrometers thick, and mounted them on a potassium chloride disk. Spectra were obtained at 2-cm^{-1} resolution. 100 spectra were obtained during a 71 second scanning time. By carrying out carbon black base-line corrections, the spectra obtained were good enough to determine the presence of SBR polymer.

The current state of the art FTIR instruments are capable of much faster scanning rates than those used by Devlin, and as such, even better spectra would be expected. The high scanning rates enables several hundred spectra to be collected in a few seconds and analysed leading to high signal to noise levels. The use of infrared microscopes means that sample sizes of a few micrograms can be located in the beam and analysed. Library search facilities are available to assist in the rapid identification of the spectrum. A gas chromatograph can now be linked to an FTIR instrument so that each peak eluting from the chromatography column can be scanned and a spectrum produced.

1.4.7. Scanning Electron Microscopy

The scanning electron microscope is a unique instrument and has been applied in several areas of interest to the rubber industry. The characteristics which make it so useful include good resolution, wide magnification range (10-100,000x) and a high depth of focus. With the addition

of an X-ray analyser, problem solving capabilities are greatly increased. Mercer (105), described the use of such an instrument and showed how it could be used to identify small areas of contamination such as badly dispersed zinc oxide. It was also shown how the method could be used to identify blooms of antidegradants or other ingredients on the surface of rubber sheets.

1.5. Purpose of the Present Project

An extensive review of the literature available on the chemical analysis of passenger tyres and rubber compounds, has shown that no work has been carried out on the quantitative analysis of sulphenamide accelerators using high pressure liquid chromatography.

Some workers have determined the type of accelerator used in vulcanisates by gas chromatographic separation of derivatives. Accelerators in unvulcanised rubber compounds have been identified using thin layer chromatography for many years, but it is not possible by this method to generate high quality quantitative results.

The first aim of the present study is to develop a method for the identification and quantitative determination of sulphenamide accelerators in vulcanisates using high pressure liquid chromatography. It is known that the sulphenamide accelerators decompose during the vulcanisation process liberating an amine which is specific to the type of accelerator used. It is proposed, therefore, to attempt to isolate and determine the amines,

provided that large quantities are not lost during the heat of vulcanisation. Most, if not all, of the work carried out on the study of vulcanisation has involved the use of natural rubber or short chain molecules to simulate natural rubber in model compound analysis.

The second aim of this project, is to examine the reaction product of sulphur and accelerator using a styrene-butadiene co-polymer system, to determine whether the first order reaction for sulphur crosslinking, as found for natural rubber systems still holds good.

The reasons for the addition of antidegradants to rubber have been discussed in section 1.1.3.6. and several methods of analysis have been evolved for their analysis, (75-81). Due to their relative insolubility in rubber compounds at normal temperatures, antidegradants have a tendency to migrate through the rubber mix. This brings about an obvious benefit, in that fresh antidegradant continues to bloom to the surface, providing a continuous source of material to prevent oxidative scission of the rubber chains at the surface. However, there is also a disadvantage in that migration takes place in all directions and the concentration of antidegradant in one compound can fall as it migrates into another compound adjacent to it. Hence, the antidegradant concentration in tyre sidewalls, where high levels of protection are required, can fall to very low levels by migration into the tyre casing or inner liner where high concentrations

are not required.

Infrared spectroscopy has been used by Smith et al (106), to measure the antidegradant amount and loss during the aging of neoprene rubbers. Nah and Thomas (107), measured the migration and blooming of waxes to the surface of rubber compounds. The bloomed wax was scraped off using a razor blade, and the weight loss of the sample recorded. They suggested that the driving force was due to stresses set up around the precipitated wax crystals and this moved the wax to the surface where it was unstressed. This mechanism could also apply to antidegradants.

Paraphenylene diamine antidegradants are soluble to a limited extent in water which is slightly acid. Nix (108), showed that providing paraffin wax was present, water leaching was reduced. He tried to predict the amount of paraphenylene diamine type of antidegradant that would be lost as a function of its molecular weight, but the results were inconclusive.

Sain (109), on the diffusion of rubber additives in elastomers, showed that the surface area of the carbon black plays a part in the diffusion process; large surface areas slowed down the rate of antidegradant migration. Rates of migration were measured by the use of radioactively tagged sulphur and antidegradants so that their activity could be measured with a Geiger-Muller counter.

The literature survey has shown that no information is available on the measurement of antidegradant migration from regions of high concentration to areas containing little or no antidegradant. The third part of this study will concentrate on this aspect. Work will be carried out using composite samples of sidewall/casing/inner liner compounds, with analysis of the migration rates using High Pressure Liquid Chromatography.

CHAPTER 2

GENERAL EXPERIMENTAL TECHNIQUES

2.1. High Pressure Liquid Chromatography

The equipment used in this work consists of three basic modules:-

- 1) Microprocessor, pump and column system
- 2) ultraviolet/visible Light detector
- 3) Printer/Plotter and Data Handling System

1) The high pressure liquid chromatograph used was a Varian Model 5000, which has a single pump with two computer controlled proportioning valves, allowing the use of two eluting solvents. A keyboard allows various parameters, which are displayed on a cathode ray tube, to be built up into a programme. Line drawings of this module are shown in Figures 9a and 9b.

The main functions in building up a programme are:-

- a) minimum pressure of solvent allowed
 - b) maximum pressure of solvent allowed
 - c) column heater temperature
 - d) flow rate of eluting solvents at any specified time
- and
- e) the percentage composition of the solvent mixture at any specified time.

Up to nine different programmes can be stored in the memory.

FIGURE 9a

FRONT VIEW OF THE LIQUID CHROMATOGRAPH

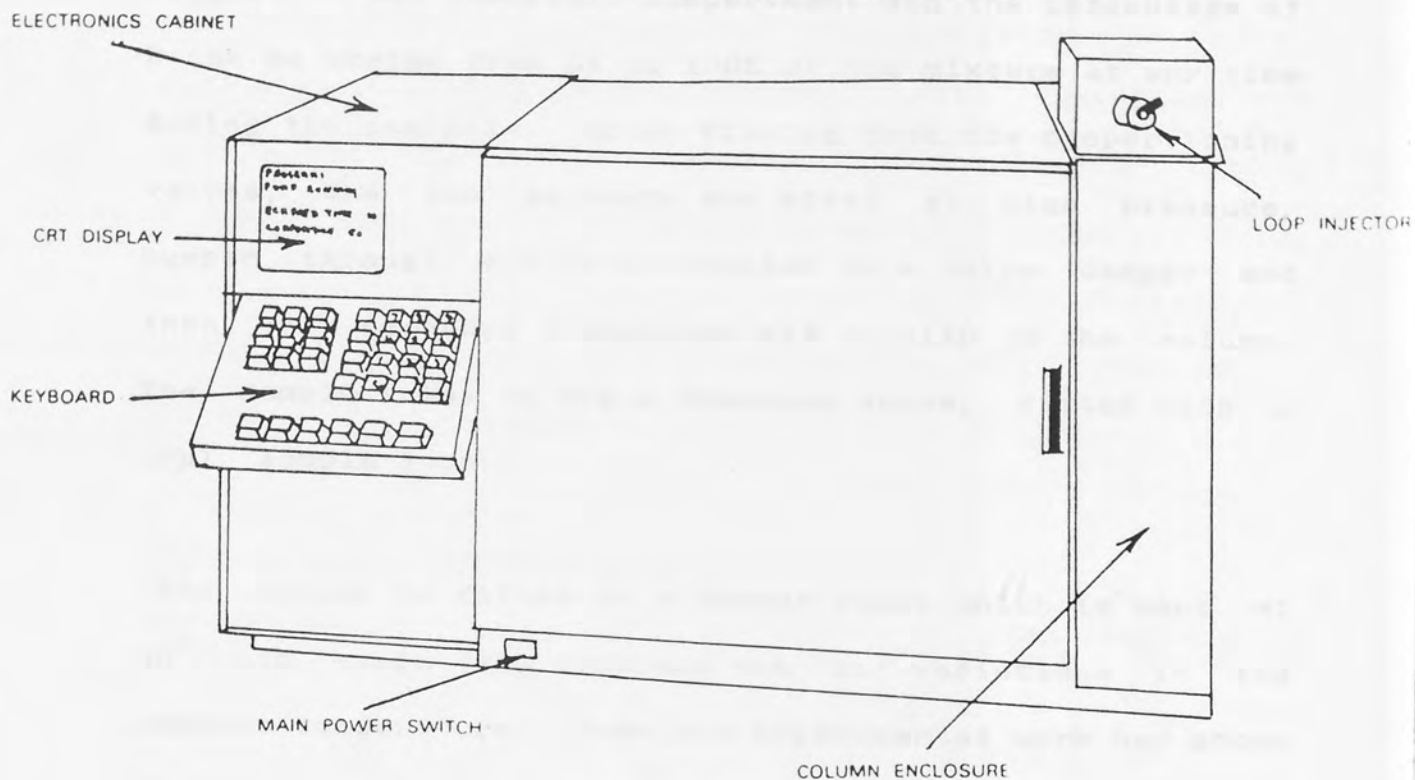
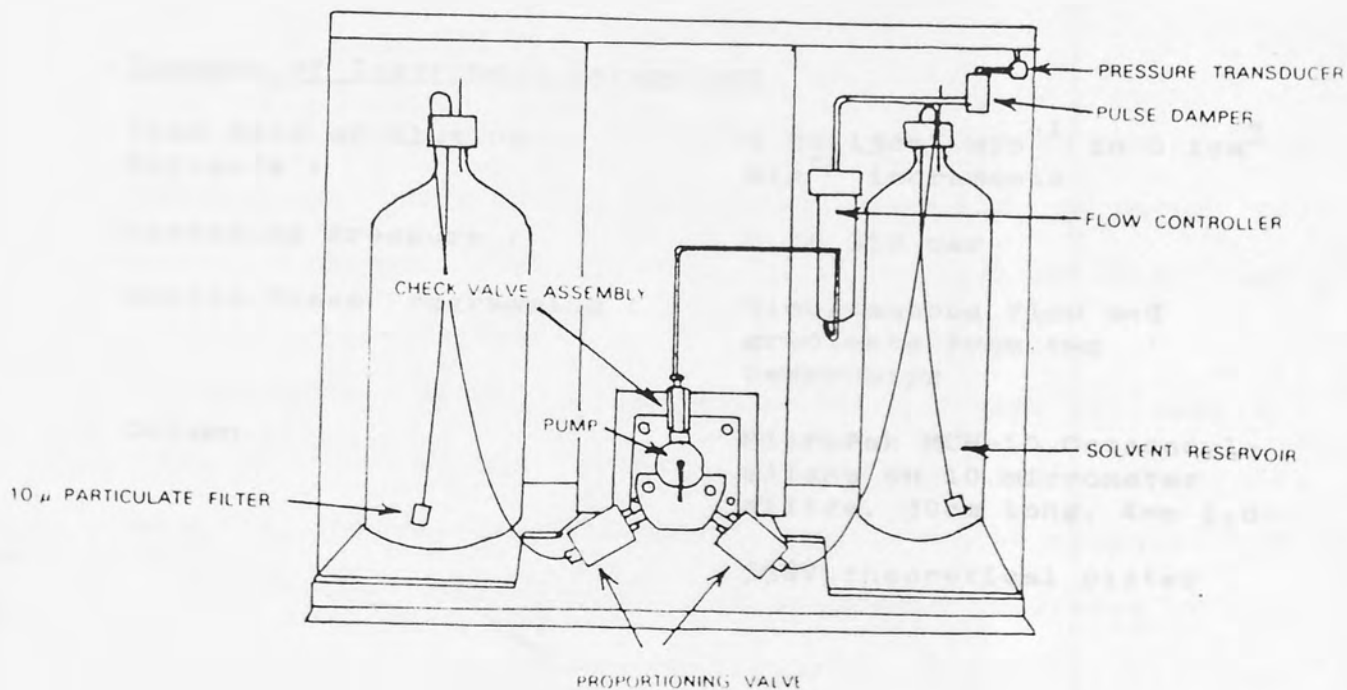

FIGURE 9b

VIEW OF RESERVOIR COMPARTMENT



The two solvents are in positions A (left) and B (right) in the reservoir compartment and the percentage of B can be varied from 0% to 100% of the mixture at any time during the analysis. After flowing from the proportioning valves, the two solvents are mixed at high pressure, pumped through a flow controller to a pulse damper and then to a pressure transducer and finally to the column. The sample inlet is via a Rheodyne valve, fitted with a 10 μ l sample loop.

The column is fitted in a heater block which is kept at 30 $^{\circ}$ C to avoid any problems due to variations in the ambient temperature. Previous experimental work had shown that separation of accelerators and antidegradants was better when using reverse phase chromatography, so the column packing chosen was of this type.

Summary of Instrument Parameters

Flow Rate of Eluting Solvents :	0 to 15 cm ³ min ⁻¹ in 0.1 cm ³ min ⁻¹ increments
Operating Pressure :	0 to 350 bar
Mobile Phase Programming :	Simultaneous flow and gradients from two reservoirs
Column :	MicroPak MCH-10 Octadecylsilane on 10 micrometer silica. 30cm long. 4mm i.d. 5587 theoretical plates

2) The ultraviolet/visible light detector used was a Varian UV-50. A line drawing of the detector is shown as Figure 10. The eluting solvent, from the column, is passed into a flow-through cell positioned in the light beam. The wavelength range may be continuously varied from 190nm to 700nm calibrated in 2nm increments. Although the wavelength is generally held at a given value during the analysis, it could be changed manually at any time to a new value if desired.

Main Specifications of the Detector

Monochromator :	1200 lines mm ⁻¹ grating, blazed at 250 nm
Optics :	Double Beam
Flow Cell :	1mm diam. 8 microlitre volume
Spectral Bandwidths :	2, 4, 8, or 16 nm
Photometric Presentation :	0.005 to 2.0 absorbance units full scale in 9 steps

3) The printer/plotter and data handling system are in one module, a Vista 401. The output from the detector is linked into one of four input channels, all of which can operate simultaneously.

A keyboard allows method parameters, (name of sample; type of calculation; attenuation; chart speed; detector response values; names of peaks; etc.) to be keyed in and a cathode ray tube displays the programme or status of the equipment. The system has 80 kilobytes of memory, which is

extended by two floppy disk drives, enabling 254 kilobytes to be stored on each.

The system measures retention times of peaks, calculates peak areas and carries out any of a number of types of calculation. It will automatically set peak detection thresholds in response to measured signal noise. The peak baselines can be shown on the chromatogram and altered if necessary to optimise peak integration.

Any relative response values are automatically calculated and percentage area, normalisation, internal or external calculations are calculated.

Main Specifications

a) Basic Unit:

Signal Input Voltage Range :	-400 mV to +1V
Sampling Rate :	20 samples sec ⁻¹
Storage Capacity :	10 methods and 1500 peaks

b) Printer/Plotter :

Chart Speeds :	0.1 to 30 cm min ⁻¹
Attenuation :	1, 2, 4, 8, 16, 32, 64, 128, 256, 512, 1024

The Vista 401 is shown as a line drawing in Figure 11.

FIGURE 10

MAIN CONTROLS OF THE ULTRAVIOLET DETECTOR

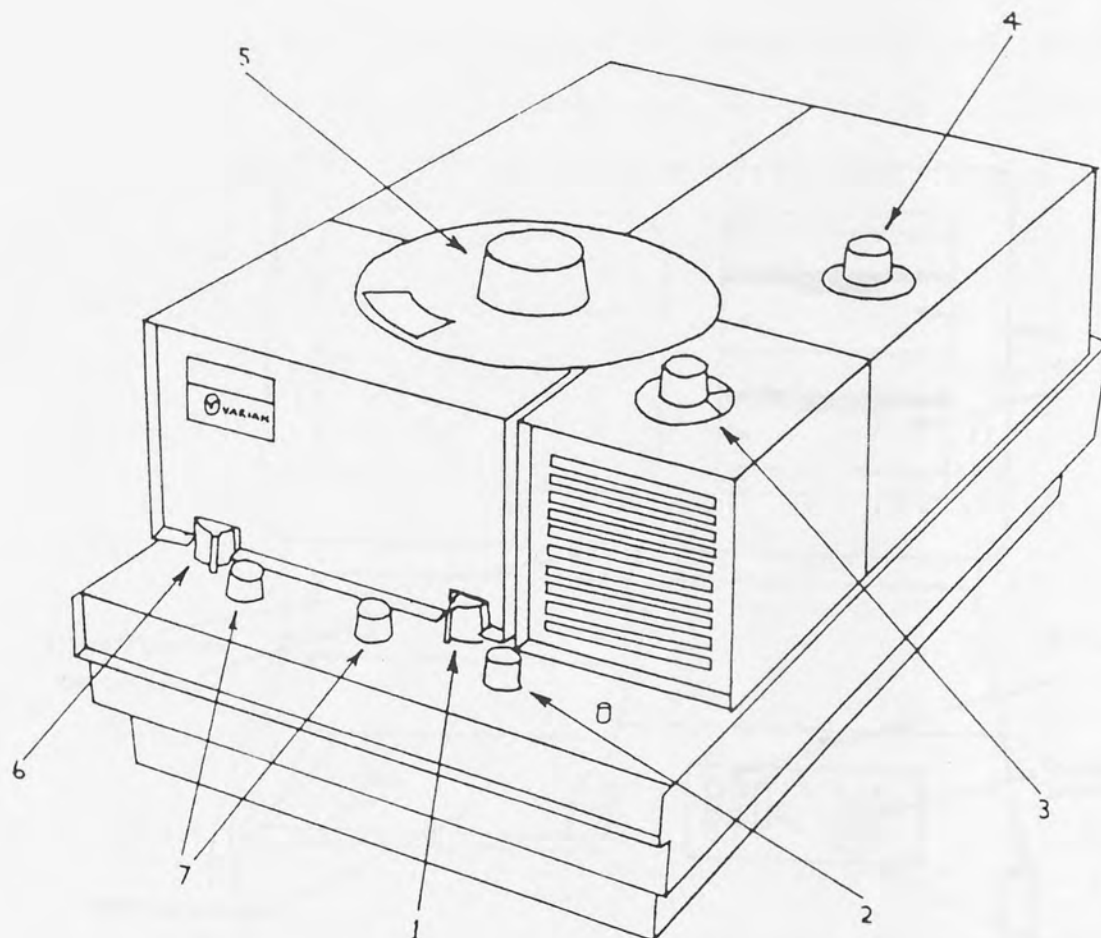

- 1. Time constant switch. Lets you select variable time constants of 0.5, 1 or 2 seconds, important for maximizing signal-to-noise ratio.
- 2. Nine full scale sensitivity ranges, 0.005, 0.01, 0.02, 0.05, 0.1, 0.2, 0.5, 1.0 and 2.0 a.u.f.s, coupled with Varichrom's extremely low noise, permit higher sensitivity over the entire spectral region.
- 3. Lamp selector. Both a tungsten and a deuterium lamp come standard with the

- system permitting operation from 190 nm to 700 nm, enough to detect absorption in the UV or Vis range.
- 4. Spectral bandwidth selector allows you to set the spectral bandwidth or bandpass at 2, 4, 8 or 16 nm. The larger bandwidths are used for increased light throughput; the smaller where spectral resolution is a concern.
- 5. Wavelength selector gives you continuous adjustment over the entire range of the

- instrument from 190 to 700 nm in 2-nm increments, permitting a compound to be seen at its optimum wavelength and at its lowest minimum detectable quantity (MDQ).
- 6. Sample Cell Selector may be used to choose either optical path as the sample beam.
- 7. Coarse and Fine Zero Controls. These continuous potentiometers are used to balance the recorder baseline.

FIGURE 11

FRONT VIEW OF VISTA 401 DATA STATION

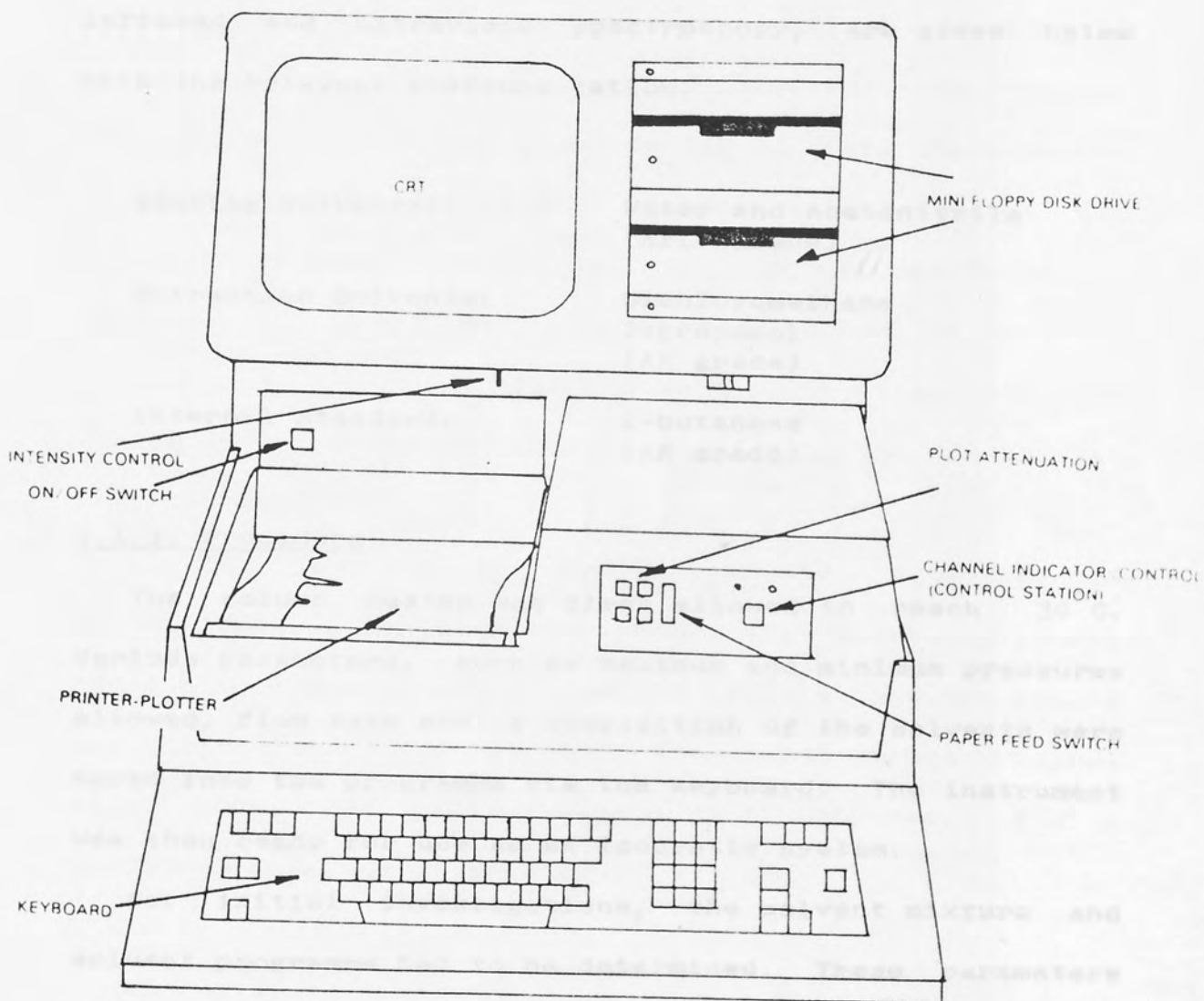

REAGENTS

The reagents used for the solvent extraction of rubber compounds and the subsequent separation of antidegradants and accelerators by HPLC are shown below. The reagents used for the preparation of derivatives and for use with other techniques, such as thin layer chromatography; infrared and ultraviolet spectroscopy, are given below with the relevant instrumentation.

Eluting Solvents:	Water and Acetonitrile (HPLC grade)
Extraction Solvents:	Dichloromethane 2-propanol (AR grade)
Internal Standard:	2-butanone (AR grade)

2.1.1. Procedure

The column heater was first allowed to reach 30°C. Various parameters, such as maximum and minimum pressures allowed, flow rate and % composition of the solvents were keyed into the programme via the keyboard. The instrument was then ready for use as an isocratic system.

For initial investigations, the solvent mixture and solvent programme had to be determined. These parameters were then keyed into the programme and the pumping system activated. Once the solvent pressure was stable, the detector was switched on, the ultraviolet or tungsten lamp selected and the wavelength of the monochromator set to the desired value.

The sample identification, attenuation, chart speed etc, were keyed into the data system of the Vista 401 and the programme brought to a ready state by pressing the control station key. The position of the recorder baseline was then noted and adjusted to the required position (5% or 10% full scale).

An aliquot of the prepared sample solution was taken up in a 100 microlitre syringe and injected into the 10 microlitre loop of the Rheodyne valve. This was repeated at least twice to ensure that the loop was washed out and full of sample. The valve was then repositioned to 'inject' to allow the sample to be washed on to the column. At the same time the control station key was activated to start the collection of data and the solvent programme also activated.

At the end of the analysis, the data system automatically calculates the areas of the separated peaks, carries out any internal standard calculations and prints out the results. The system is then reset to its original state ready for the next sample or re-programmed for a different analysis if necessary.

2.1.2. Preparative HPLC

The system was also fitted with a preparative column (25 cm long x 20 mm diameter) packed with Techsil 10 C18, having 11,027 theoretical plates, so that large quantities of derivatives or reaction products could be separated and collected for subsequent analysis.

The 10 microlitre loop of the rheodyne valve was replaced by one of 0.5 or 1ml capacity. The flow rate was increased from 1 cm³ per minute to 15 cm³ per minute. Fractions were collected from the system immediately after flowing through the cell in the detector.

2.2 Ultraviolet and Visible Light Spectroscopy

The instrument used was a Beckman Model 25 double beam spectrophotometer.

The parameters used in this work were:-

Slit Width :	1.0 mm
Wavelength Speed :	100 nm/min
Chart Speed :	5 inches/min
Chart Span :	2Au full scale
Cell pathlength :	0.5cm

2.2.1. Procedure

For analysis of materials such as sulphenamide accelerators and antidegradants, which contain conjugated double bonds, the ultraviolet lamp was selected and samples scanned between 200 and 340nm. The samples were prepared by dissolving about 0.4g of material, weighed to 5 decimal places, in 5 cm³ of dichloromethane. Each solution was made up to 100 cm³ in a low actinic glass volumetric flask using 2-propanol. (except for MBT, which was made up to 250 cm³). 10 cm³ of this solution was pipetted into a second 100 cm³ low actinic glass

volumetric flask and made up to volume with 2-propanol.

Ultraviolet spectra were obtained using an aliquot of the final solution in a 0.5cm pathlength cell, with 2-propanol in the reference cell. The baseline was first checked using 2-propanol in both cells and recorded on the same chart.

Derivatives of the accelerator amines were yellow and to determine the optimum wavelength of absorption, the spectra were recorded throughout the visible light range of 350 - 700nm. No attempt at quantitation was made as this would be carried out using the liquid chromatograph.

2.3. Thin Layer Chromatography

This technique has been available for many years and has been used successfully for the identification of many additives in rubber compounds.(110-118) In its early form, separation of additives was carried out using specially prepared paper, but this restricted the layer material to cellulose. Small particle size silica and aluminium oxide were developed, mixed with small proportions of calcium sulphate as a binder, and spread on to glass plates. Backing materials of plastics, such as polyesters, replaced the glass plate enabling the separated components to be cut out from the plate for subsequent extraction and identification by other analytical methods.

The advent of silicas with very small particle sizes (5-10 microns) has led to 'High Performance' thin layer plates, with faster elution times without any loss of separation.

Modern thin layer chromatography can be used over a wide range of sample types. Normal, reverse phase and ion exchange layers are available using silicas, aluminium oxides, keiselghur and resins.

Elution can be carried out in a single direction or in two directions at 90 degrees to each other using two different solvents.

R_f values, calculated from the ratio of the distance travelled by the spot divided by the distance travelled by the solvent front, can be used as an aid to identification.

The thin layer plates used in this work were Alugram Nano-sil G, 10 x 10 cm, layer thickness 0.2mm.

2.3.1. Procedure

The plates were dried in an oven at 100°C for 30 minutes before use. Spots were transferred to the plate using a 10 microlitre syringe at a distance of 2.5cm from the bottom edge of the plate. After allowing the spots to dry, the plate was placed in a glass tank lined with filter paper containing the appropriate solvent in the

bottom to a depth of 1cm. (The filter paper lining absorbed some of the solvent so that a saturated solvent vapour was present in the tank to give better chromatography.) The solvent was allowed to travel up the layer to a height of 6cm from the original spot. The plate was then removed, allowed to dry and sprayed, if required, with a reagent to develop the separated spots.

The solvents and the spraying reagents used for the analyses will be described in detail in the relevant chapter.

2.4. Infrared Spectroscopy

The instrument used in this work was a Nicolet 5SXC Fourier Transform Infrared Spectrophotometer. The system was optimised for operation in the range $4800-400\text{cm}^{-1}$ at better than 2cm^{-1} resolution. The data system comprised an NIC 620 super mini computer with 640 kbyte memory of 20 bit word length, high speed 16 bit ADC, 50 Mbyte storage module with dual 3.5 inch micro-floppy drives, high performance colour raster display, ASCII keyboard and 2-pen digital plotter.

The optical path is shown in Figure 12.

FIGURE 12

THE OPTICAL PATH SYSTEM OF THE FTIR SPECTROPHOTOMETER

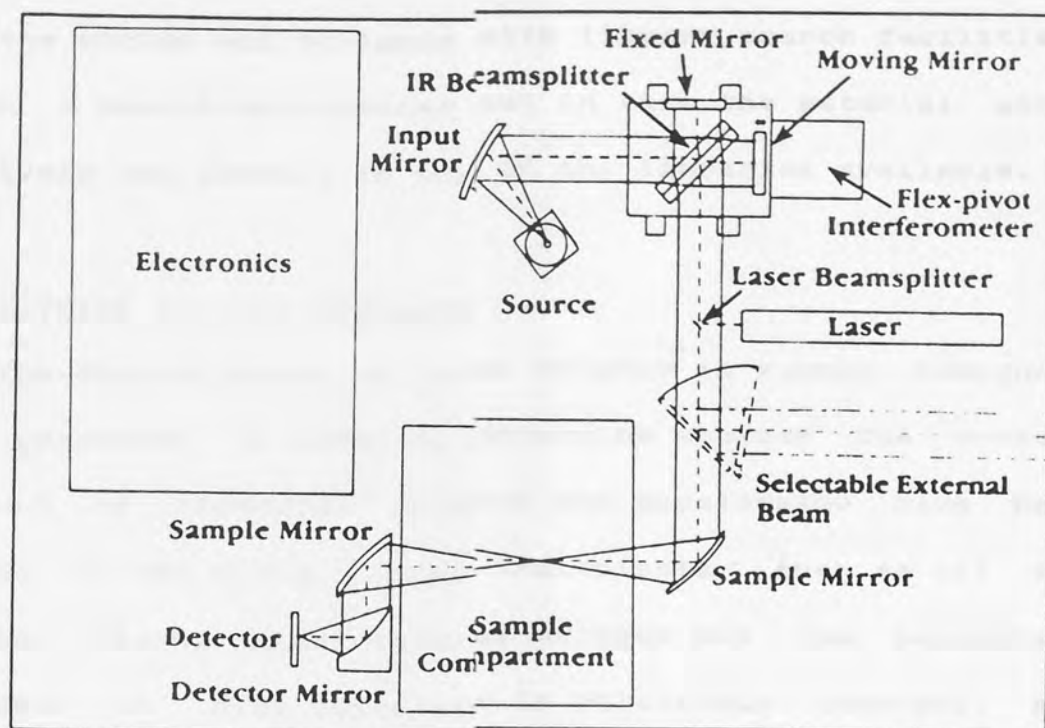

2.4.1. Procedure

The sample was prepared either as a thin film from solution on a potassium bromide plate, or ground with potassium bromide powder in an agate mortar then pressed into a thin disk using a stainless steel die and 154MN/m^2 pressure. The plate or disk was then inserted into a sample holder and placed into the sample position in the spectrophotometer.

Parameters such as number of scans per second, scanning time, scale expansion etc were keyed into the mini-computer. The scans then started and the infrared spectrum was obtained on the VDU. Any baseline corrections were carried out at this stage and either absorption or

transmission mode selected. When the spectrum was satisfactory, it was printed out on the chart paper. As the system was equipped with library search facilities, such a search was carried out in case the material under analysis was present in any of the libraries available.

2.5. Total Sulphur Analyser

The determination of total sulphur in rubber compounds is necessary in order to determine whether the correct amount of elemental sulphur and accelerator have been added to the blend. Other ingredients, such as oil and carbon black, also contain sulphur but the percentage sulphur in these materials is relatively constant, and allowances can be made for them.

The instrument used for sulphur determinations was a Leco HF-10 Model 777-300 induction furnace, together with a Model 532-500 automatic sulphur titrator.

The characteristics of the furnace are shown below:-

Oscillator Output

Frequency :	14 MHz
Power :	1200 Watts
Grid Current :	110-120 mA
Plate Current :	325 mA
Plate Voltage :	+2400 VDC +/- 5%
Filament Voltage :	10.5 VAC +/- 5%

The front view of the furnace is shown in Figure 13.

A front view with the front panel removed is shown in Figure 14 and the complete apparatus is shown in Figure 15.

The automatic sulphur titrator consists of a titration vessel which contains a solution of dilute hydrochloric acid, potassium iodate and starch. Sulphur dioxide from the combustion of the sample in oxygen, travels from the furnace via a heated tube into the solution in the titration vessel. The free iodine liberated from the potassium iodate is converted to hydrogen iodide by the sulphur dioxide and the initially blue solution begins to fade. A photoelectric cell, at the bottom of the titration vessel, measures the colour change and sends a signal to a valve which opens to allow fresh potassium iodate to flow from a burette into the titration vessel. Once the initial colour has been restored the valve closes, but as more sulphur dioxide enters the titration vessel and the colour again fades, the process of adding potassium iodate is repeated.

When all the sulphur dioxide has entered the titration vessel and the colour is constant, the amount of potassium iodate delivered can be read from the burette and the total sulphur content calculated.

The analysis proceeds according to the following equations:-

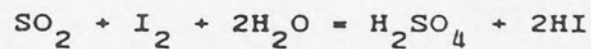

FIGURE 13

FRONT VIEW OF LECO INDUCTION FURNACE

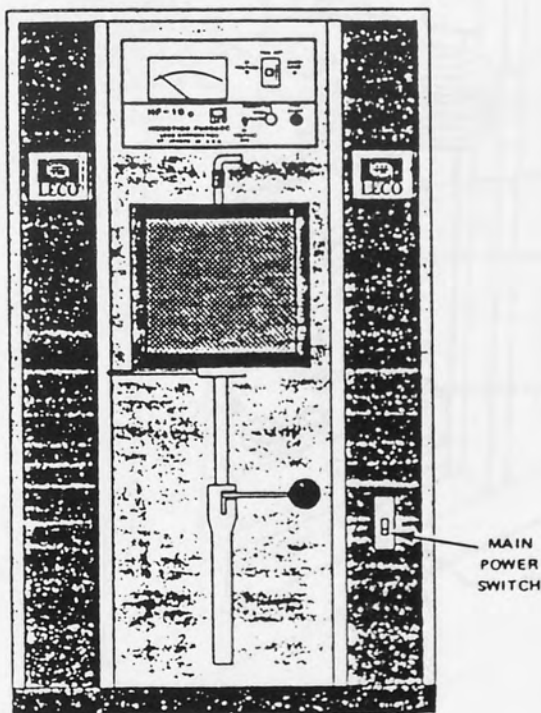

FIGURE 14

FRONT VIEW OF FURNACE WITH FRONT COVER REMOVED

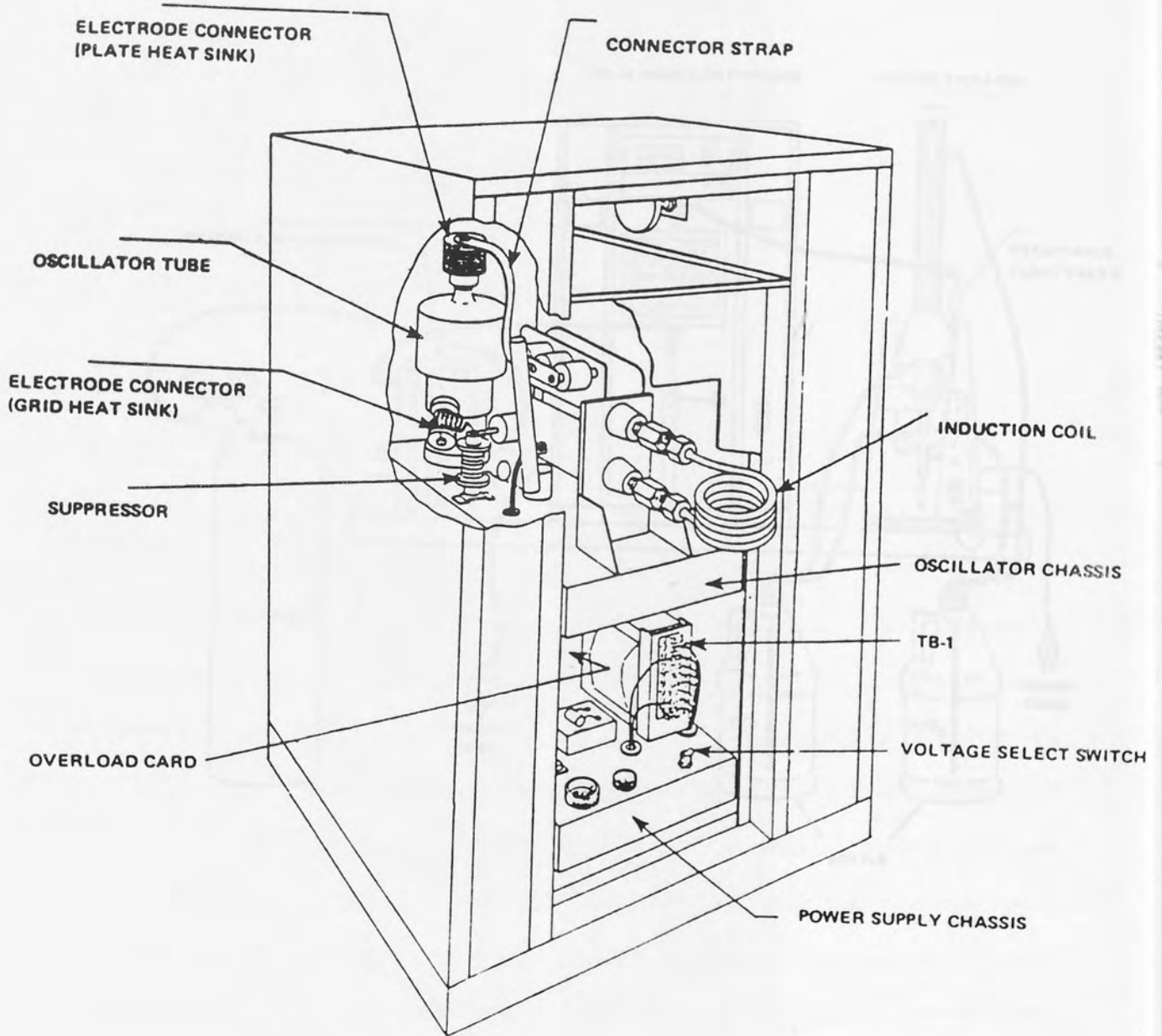
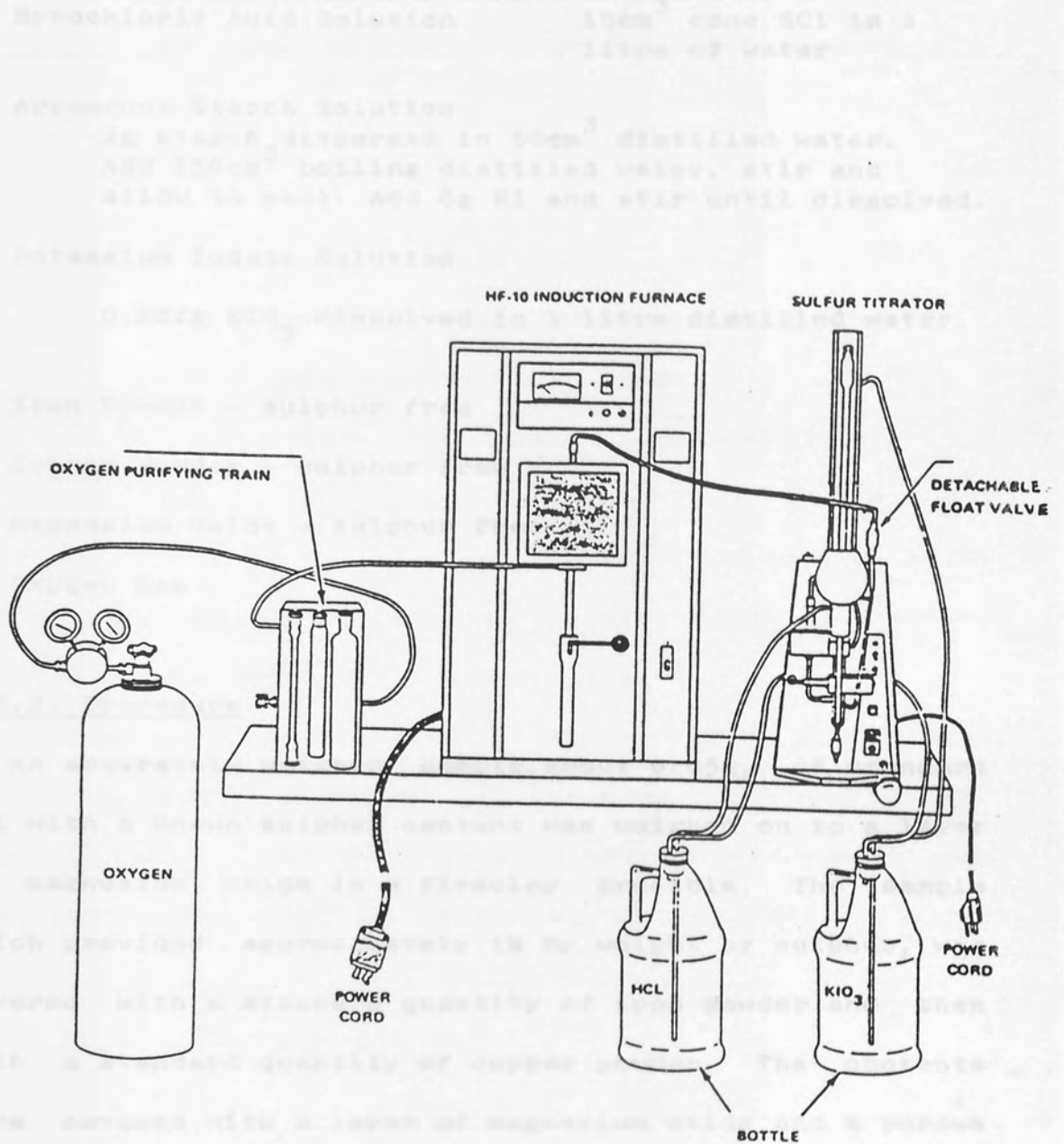

FIGURE 15

OVERALL VIEW OF TOTAL SULPHUR APPARATUS



2.5.1. Reagents

Hydrochloric Acid Solution 15cm³ conc HCl in 1
litre of water

Arrowroot Starch Solution
2g starch dispersed in 50cm³ distilled water.
Add 150cm³ boiling distilled water, stir and
allow to cool. Add 6g KI and stir until dissolved.

Potassium Iodate Solution
0.222g KIO₃ dissolved in 1 litre distilled water.

Iron Powder - sulphur free

Copper Powder - sulphur free

Magnesium Oxide - sulphur free

Oxygen Gas

2.5.2. Procedure

An accurately weighed sample, about 0.05g, of standard oil with a known sulphur content was weighed on to a layer of magnesium oxide in a fireclay crucible. The sample which provided approximately 1% by weight of sulphur, was covered with a standard quantity of iron powder and then with a standard quantity of copper powder. The contents were covered with a layer of magnesium oxide and a porous silica lid placed over the crucible. The crucible was inserted into the induction furnace. The titration vessel was filled with the dilute hydrochloric acid solution, 10cm³ starch added and the system set to the endpoint mode. Potassium iodate was automatically added from the burette until a standard blue colour was attained.

2.5.3. Calculation of Sulphur Content

The amount of potassium iodate consumed during the analysis was used to calculate a calibration factor as shown below:-

$$F = \frac{S \times W}{V}$$

Where: F = calibration factor
S = percentage sulphur in standard
W = weight of standard in gm
V = volume of potassium iodate used

The analysis of the standard was repeated several times and the average calibration factor calculated. Successive results should not vary by more than 0.01.

Samples were then analysed, taking 10-20 mg for sulphur levels up to 4%, using exactly the same procedure as for the standard. The percentage sulphur in the sample was then determined using the following calculation:-

$$\%S = \frac{F \times V}{W}$$

Where: F = calibration factor
V = volume of potassium iodate used
W = weight of sample in gm

NOTE: The use of a calibration factor is necessary because not all of the sulphur is converted to SO_2 and some SO_3 is also generated. As the SO_3 takes no part in the chemical reaction with the liberated iodine, a

straightforward calculation is not possible. When analysing rubber compounds a standard compound was mixed in the laboratory with a known level of sulphur from all sources. This ensured that the matrix was similar to samples and that the ratio of SO_2 to SO_3 generated was identical between sample and standard.

2.6 Extraction Methods

2.6.1 Hot Extractions

The extraction of free amines from vulcanised rubber compounds, was carried out using a standard Soxhlet apparatus. This consisted of a 150cm^3 round, flat bottomed flask containing the solvent; a glass jacket which connected the flask to the water condenser and a liner in which the sample was placed. The liner has an automatic siphoning device so that when it filled with solvent the solvent was transferred back into the flask, carrying with it the extracted material. The sample was wrapped in a number 54 Whatman filter paper.

The assembly was heated at such a rate that the liner filled and emptied about 20 times per hour. The sample was extracted for 16 hours and the solvent used was a mixture of 90cm^3 chloroform and 30cm^3 acetone.

Subsequent treatment of the extract will be described in Chapter 4.

2.6.2. Cold Extraction

Samples used for the determination of accelerators and sulphur could not be extracted in a Soxhlet apparatus because the high temperature would break down the accelerator causing vulcanisation of the sample.

Samples for extraction were milled into thin sheets of about 0.5mm thickness and a portion of about 0.5gm was accurately weighed. This sample was cut into small pieces (about 2mm square) to expose a greater surface area, then placed in a vial containing a mixture of 5cm³ dichloromethane and 10cm³ 2-propanol. A cap and septum were screwed on the vial and it was placed in a dark box for 24 hours to allow extraction to take place. At the end of this period, the vial was placed in an ultrasonic bath and extracted ultrasonically for a further 10 minutes.

The solvent mixture was then transferred quantitatively to a low actinic glass 25cm³ volumetric flask, using a dropping pipette. 1cm³ 2-butanone was pipetted into the flask and the volume made up to 25cm³ with 2-propanol.

2.7. Compounding of Rubber Samples

2.7.1. Banbury Mixing

The mixer used to produce the first stage rubber compounds was a Size 00, 2.5 litre capacity, Bridge, laboratory Banbury. The Banbury has three major components, (i) a feed hopper, (ii) a mixing chamber, and (iii) a motorised drive.

FIGURE 16

The raw materials are added to the mixing chamber via the feed hopper and forced in under pressure by an hydraulic ram. The mixing chamber has two rotors in it which are contra-rotating and have shearing edges to keep the raw materials in constant motion. Mixing is effected by actions of milling, kneading, longitudinal cut back and lateral overlaying. These actions, together with temperature control, result in high quality dispersions in a short time. At the bottom of the mixing chamber is a sliding door to allow the mix to be discharged. Heat is generated during the mixing cycle and the mixing chamber is water cooled to keep the temperature correct.

2.7.1.1. Procedure

The rotor speed was set at 60 rpm and the polymer added. The ram was lowered for 1 minute, so that the viscosity of the polymer was lowered, then half of the required carbon black and all the small powders added. The ram was again lowered and the polymer and powders mixed for 1.5 minutes. At this stage, the rest of the carbon black and any oil were added, the ram lowered and the base stock allowed to mix for 4.5 minutes. The bottom door was then opened and the batch discharged.

A cross section of a Banbury mixer is shown in Figure 16.

FIGURE 16

A CROSS SECTIONAL VIEW OF A BANBURY MIXER

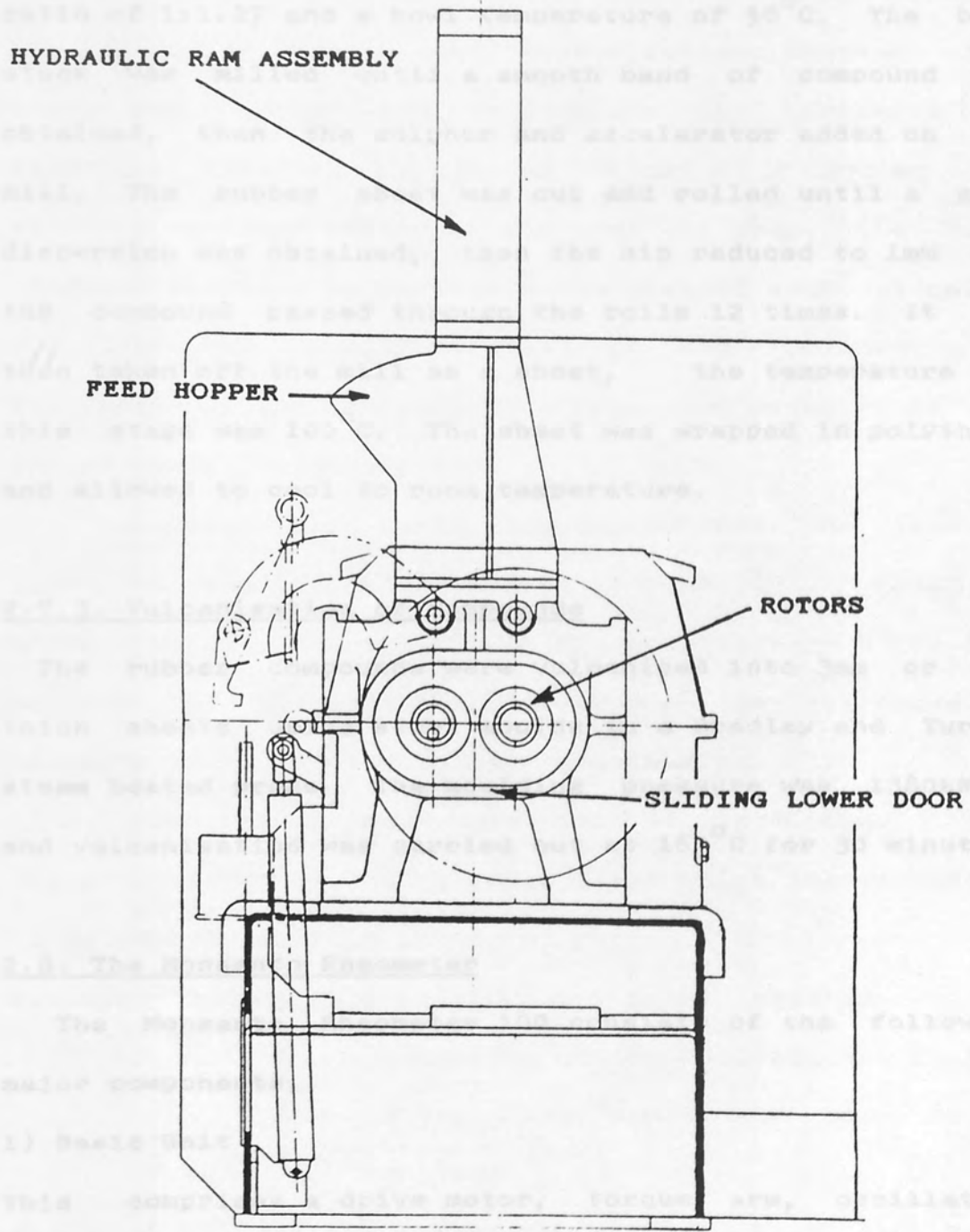

2.7.2. Open Mill Mixing

Once the base stock had been check weighed to ensure that the batch weight was correct, it was transferred to a laboratory mill. The mill rolls were 18 inches wide, 9 inches in diameter running at 19 rpm having a friction ratio of 1:1.27 and a bowl temperature of 50°C. The base stock was milled until a smooth band of compound was obtained, then the sulphur and accelerator added on the mill. The rubber sheet was cut and rolled until a good dispersion was obtained, then the nip reduced to 1mm and the compound passed through the rolls 12 times. It was then taken off the mill as a sheet, the temperature at this stage was 100°C. The sheet was wrapped in polythene and allowed to cool to room temperature.

2.7.3. Vulcanisation of Compounds

The rubber compounds were vulcanised into 3mm or 6mm thick sheets using steel moulds in a Bradley and Turton steam heated press. The moulding pressure was 1380kN/m² and vulcanisation was carried out at 165°C for 30 minutes.

2.8. The Monsanto Rheometer

The Monsanto Rheometer 100 consists of the following major components:

1) Basic Unit

This comprises a drive motor, torque arm, oscillating disc, heated die cavity, time sequence proportioning temperature controllers with triac output, pneumatic

cylinder and related pneumatic and electrical controls.

ii) Recorder

The Rheometer provides a continuous smooth curve of the elastic modulus, S' versus cure time. A polymer specimen is contained within the vulcanisation chamber under conditions of pre-set temperature and pressure. A biconical disc is oscillated through a 3 degree arc, exerting a shear strain on the test specimen. The force (torque) required to oscillate the disk is proportional to the stiffness (shear modulus) of the polymer. The stiffness of the specimen increases when cross links are formed during vulcanisation.

A complete cure curve is obtained when the recorded torque value either increases to an equilibrium value or a maximum value. The time taken to obtain a cure curve is a function of the test temperature and the vulcanisation characteristics of the polymer specimen.

A convention has been adopted to define those characteristics of the recorder trace which are considered to be important. This is as follows:

MINIMUM TORQUE : The lowest point reached at the beginning of the analysis and in this state the sample is said to be uncured.

SCORCH : A measure of how long it takes for the sulphur/polymer reaction to

start. The convention is that the scorch is the time taken for the torque to rise 2"lbs above the minimum.

MAXIMUM : The highest torque value reached before any reversion takes place.

A diagram of the Rheometer is shown in Figure 17.

2.8.1. Procedure

A disc of rubber compound, 37mm diameter, was cut from the mill sheet. This was placed on top of the biconical oscillating disc and the micro-die chamber closed. The pressure of the upper platten on the compound caused it to flow round the disc and take up the shape of the cavity. At the same time the compound was heated by the disc and the cavity walls to the operating temperature of 150°C.

The timer started when the cavity closed and the chart speed was set to the 60 minute range. Although the normal procedure is to continue the test until the maximum torque is reached, for the present work various cure times were required. For this reason, therefore, the chart was stopped and the cavity opened at different periods of time up to the time taken to maximum torque. In order to prevent any chemical reactions continuing in excess of the time the sample was at 150°C, the sample was cooled rapidly to room temperature as soon as it was taken out of the micro-die.

FIGURE 17

DIAGRAM OF A MONSANTO RHEOMETER

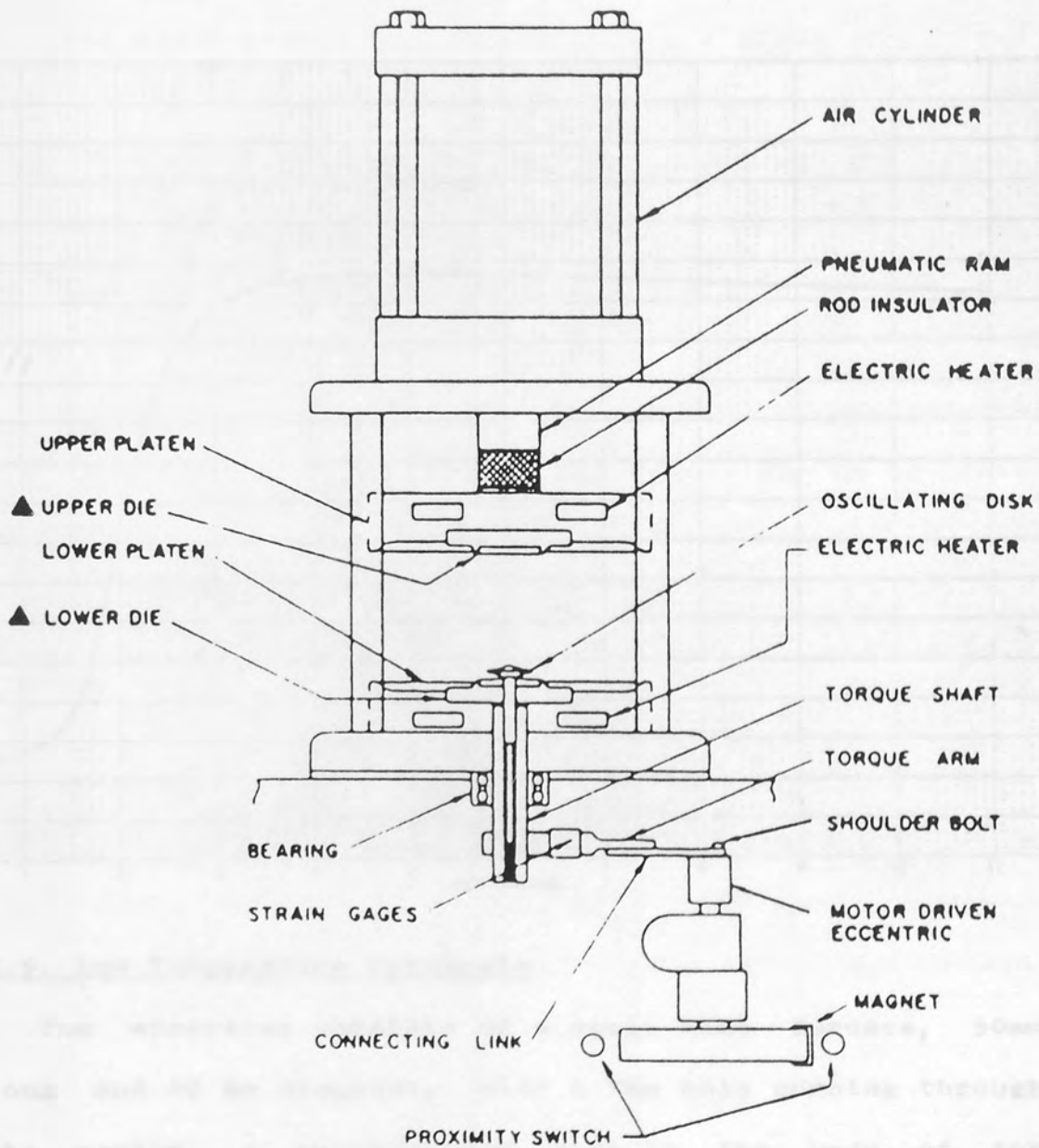

A typical rheometer curve of a rubber compound is shown in Figure 18.

FIGURE 18

A RHEOMETER CURVE OF A TYPICAL RUBBER COMPOUND

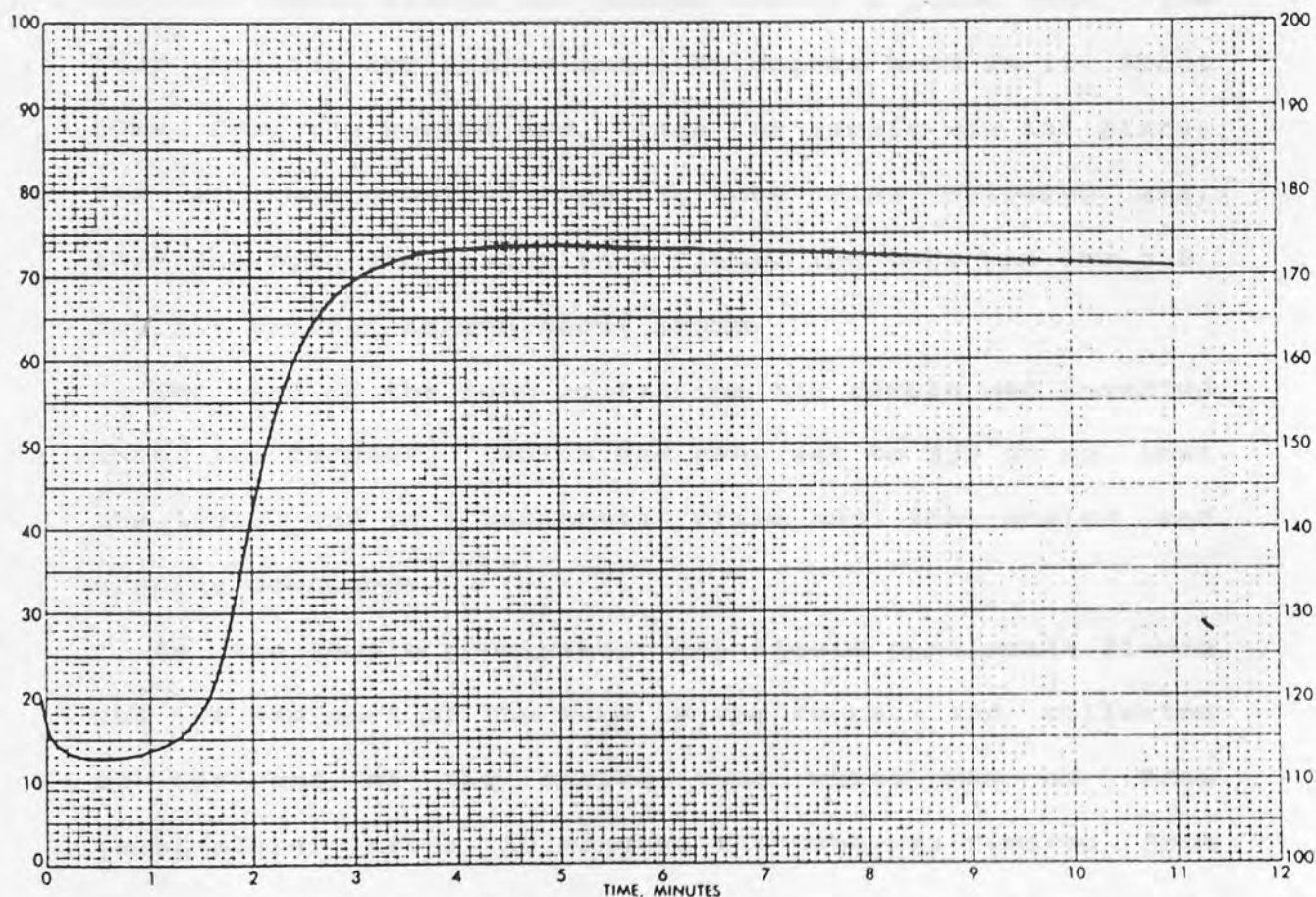

2.9. Low Temperature Pyrolysis

The apparatus consists of a small tube furnace, 50mm long and 40 mm diameter, with a 7mm hole running through the centre. A thermocouple wire in the body of the furnace, conveys a signal to a West Gardsman temperature controller. The furnace can be operated up to 1000°C. The required temperature is set by a flag on the temperature

indicating scale and when the set temperature is reached, control is carried out by a photoelectric sensor.

2.9.1. Procedure

A sample of rubber compound, weighing about 0.5g was cut into small pieces and placed inside a glass tube. The tube had one end sealed and a 45 degree bend in it about 50mm from the sealed end. Once the sample was in place, the air was expelled from the tube using nitrogen gas, then the open end sealed in a flame. The tube was 6mm o.d. and its overall length about 120mm.

The end of the tube containing the sample was inserted into the furnace, (which had been set to 350°C) so that the tube was in a horizontal plane and the angled end sloping downwards.

As the sample pyrolysed, any liquid pyrolysate flowed out of the part of the tube in the furnace and collected in the end of the angled tube which was at room temperature. After 10 minutes the tube was removed from the furnace and kept in a horizontal plane as it cooled. When cool, the tube was cut open and the liquid pyrolysate analysed.

CHAPTER 3

FATE OF ANTIDEGRADANTS

3.1. Introduction

The role of antidegradants in rubber compounds is principally to retard the oxidative scission of polymer chains. The relatively low solubility of antidegradants causes their migration to the surface of a compound, where oxygen and ozone are present at their highest levels and they play their vital role. Tyre tread and sidewall compounds contain antidegradants, whereas the under-lying casing and inner liner compounds do not. Migration would be expected to take place in all directions, not just to the surface of a tyre, so that there should be a tendency for the antidegradants to migrate into the casing and inner liner compounds to set up an equilibrium distribution.

A study was carried out to determine whether this was so, using laboratory mixed and cured compounds under various ageing conditions. The antidegradants which were included in this study were:-

1) (4,4 methylpentyl-2-)diphenylamine (6PPD)

which has the structure:

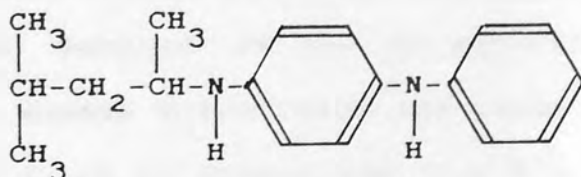

This is an antioxidant/antiozonant giving high levels of heat ageing, flexing resistance and protection against copper contamination. It gives protection also against ozone under both dynamic and static conditions of exposure.

2) Polymerised 1.2.dihydro 2.2.4.trimethylquinoline (TMQ)

The monomer has the structure:-

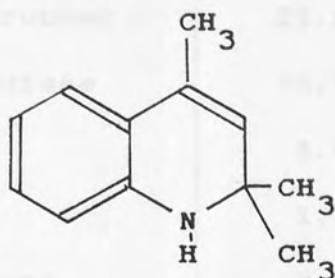

This is a general purpose, staining antioxidant. It is only moderate in its protection against flexing.

3.2. Formulations of Rubber Compounds

Two typical sidewall compounds were mixed, containing exactly the same ingredients except for the antidegradants; one compound contained 6PPD and the other TMQ. Typical casing and inner liner compounds were also prepared. The formulations are shown in Tables 3,4 and 5.

3.3. Manufacture of Test Specimens

a) Samples of the two sidewall compounds were milled into sheets 0.6cm thick and cured for 20 minutes at 165°C into slabs of dimensions, 9 x 5 x 0.6 cm .

TABLE 3

FORMULATION OF SIDEWALL COMPOUNDS

INGREDIENT	PARTS BY WEIGHT	
	AN5374/A	AN5374/C
Finaprene 377 SBR	50.00	50.00
SMR 10 Natural rubber	25.00	25.00
Intene Polybutadiene	25.00	25.00
Zinc Oxide	5.00	5.00
Stearic Acid	1.30	1.30
6PPD Antidegradant	3.00	nil
TMQ Antidegradant	nil	3.00
Paraffin Wax	2.00	2.00
N326 Carbon Black	50.00	50.00
Petroleum Tack Resin	4.00	4.00
Enerflex 94 Oil	3.00	3.00
Insoluble Sulphur	2.50	2.50
MBS Accelerator	0.80	0.80
TOTAL PARTS	171.60	171.60

TABLE 4

FORMULATION OF CASING COMPOUND

INGREDIENT	PARTS BY WEIGHT
SMR 20 Natural Rubber	70.00
SBR 1502	30.00
Reclaim Rubber	30.00
Zinc Oxide	4.00
Stearic Acid	1.00
N660 Carbon Black	45.00
Dutrex RT Oil	4.95
Process Oil	0.90
Petroleum Tack Resin	2.40
Soluble Sulphur	1.00
Insoluble Sulphur	2.13
MBS Accelerator	0.90
Retarder PVI 50	0.25
TOTAL PARTS	192.53

TABLE 5

FORMULATION OF INNER LINER COMPOUND

INGREDIENT	PARTS BY WEIGHT
Chlorobutyl Rubber	65.00
SMR Natural Rubber	20.00
SBR 1712 Rubber	15.00
Stearic Acid	0.95
Zinc Oxide	2.85
N660 Carbon Black	55.00
Dutrex RT Oil	9.00
Calcium Carbonate	50.00
Magnesium Oxide	0.50
Vultac 7	0.65
MBTS Accelerator	0.95
TMTD Accelerator	0.20
TOTAL	220.10

The cured slabs were used as controls, since migration could only take place to the surfaces of the slabs and this could be remilled into the compound before analysis.

b) A composite sample, AN5374/B was then manufactured to simulate a section through a tyre sidewall by curing a slab made up from a 3mm layer of AN5374/A, then a 1.5mm layer of casing compound, and finally a 1.5mm layer of

inner liner compound, for 20 minutes at 165°C. This gave the same slab thickness as the control specimens so that the migration rate would be comparable with the control. A cross sectional view of the composite slab make-up is shown in Figure 19.

FIGURE 19

CROSS-SECTION OF TYRE SIDEWALL COMPOSITE SLAB

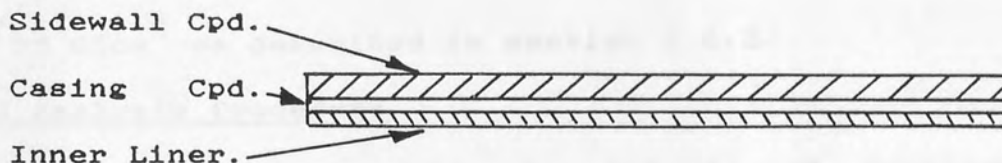

c) A second composite AN5374/E was made in a similar manner but using the sidewall compound containing TMQ.

3.4. Ageing of Test Specimens

Samples of each of the test specimens were analysed immediately after cure at a zero ageing time. Further samples of each test specimen were aged for 100, 200 and 400 hours in an atmosphere of nitrogen at 100°C. A second set of specimens were aged in an environmental chamber for 114 days at 50°C and 95% relative humidity. Samples of 6PPD antidegradant were heated at 100°C for various intervals of time up to 730 days.

3.5. Preparation of Specimens for Analysis

The three layers of the composite blocks, AN5374/B and /E, were carefully cut apart at the interfaces between the different rubber compounds. Samples were taken after each stage of the ageing systems. Each individual compound, including the controls AN5374/A and /D, was then milled into a sheet of approximately 0.5mm thickness using a 6" laboratory mill having cold, even speed rolls. Samples of about 0.5g of the milled sheet were weighed to the nearest 0.01mg, cut into small pieces and extracted with 15cm³ solvent in a sealed tube. The extract was then made up to 25cm³ as described in section 2.6.2.

3.6. Analysis Procedure

The conditions used for the analysis of accelerators and antidegradants by HPLC were determined in earlier work by Thompson (110). The actual conditions used for the analysis of the test specimens in the current work are shown in Tables 6 and 7.

TABLE 6

HPLC INSTRUMENT CONDITIONS

SOLVENT FLOW RATE	1cm ³ /min
COLUMN	30cm x 4mm i.d. 10 micrometer silica. Coated with octadecylsilane.
COLUMN TEMPERATURE	30°C
CHART SPEED	0.2cm/min
DETECTOR	254nm wavelength
ATTENUATION	0.125 A.U. full scale

TABLE 7

SOLVENT PROGRAMME

TIME(min)	% 0.1M SODIUM ACETATE	% ACETONITRILE
0	70	30
2	70	30
17	50	50
20	50	50
27	30	70
40	30	70
45	0	100
50	0	100
55	70	30

10 μ l of each solution was injected into the column and the resulting chromatograms processed by the Vista 401 data system.

3.7. Results

In order to identify the antidegradants from the peaks on the chromatograms, samples of the pure antidegradants 6PPD and HTQ were dissolved in the solvent mixture and analysed under the same conditions as for the test specimens. From the resulting chromatograms, 6PPD was measured at a relative retention time of about 7.7 and TMQ at about 8.5.

The weight of antidegradant in all sample solutions was calculated using the following expressions:-

$$1) \text{ Weight of antidegradant} = \frac{\text{Aspl} \times F \times R}{\text{Astd}}$$

Where:- Aspl = Area of antidegradant peak

Astd = Area of 2-butanone peak

R = Weight in grams of 2-butanone peak

F = Detector response factor

6PPD = 0.006959

TMQ = 0.024921

$$2) \% \text{ Antidegradant in rubber test specimen}$$

$$= \frac{\text{WS} \times 100}{\text{WT}}$$

Where:- WS = weight found from solution

WT = weight of test specimen

3.7.1. Samples Aged in Nitrogen

The results for 6PPD are shown in Table 8 and the results for TMQ are shown in Table 9, each as an average of three determinations. These results are also shown in graphical form in Figures 20 and 21. The chromatograms of the initial samples are shown in Figures 22 to 29. A selection of the other chromatograms are shown in Appendix

1.

TABLE 8

LEVELS OF 6PPD AFTER CURE AND WITH AGEING IN
NITROGEN AT 100°C FOR 100, 200 AND 400 HOURS

Sample	Percentage 6PPD in test specimen			
	Initial	100hrs	200hrs	400hrs
AN5374/A Sidewall only	1.48	1.31	1.06	1.06
AN5374/B Sidewall Cpd	1.10	0.62	0.61	0.48
Casing Cpd	0.51	0.64	0.40	0.53
Liner Cpd	0.07	0.26	0.39	0.35

TABLE 9

LEVELS OF TMQ AFTER CURE AND WITH AGEING IN
NITROGEN AT 100°C FOR 100, 200 AND 400 HOURS

Sample	Percentage TMQ in Compound			
	Initial	100hrs	200hrs	400hrs
AN5374/C Sidewall Only	1.38	0.82	0.83	0.84
AN5374/E Sidewall Cpd	1.12	0.68	0.52	0.53
Casing Cpd	0.14	0.44	0.56	0.60
Liner Cpd	0.15	0.22	0.31	0.31

FIGURE 20

MIGRATION OF 6PPD ANTIDEGRADANT WITH NITROGEN AGEING

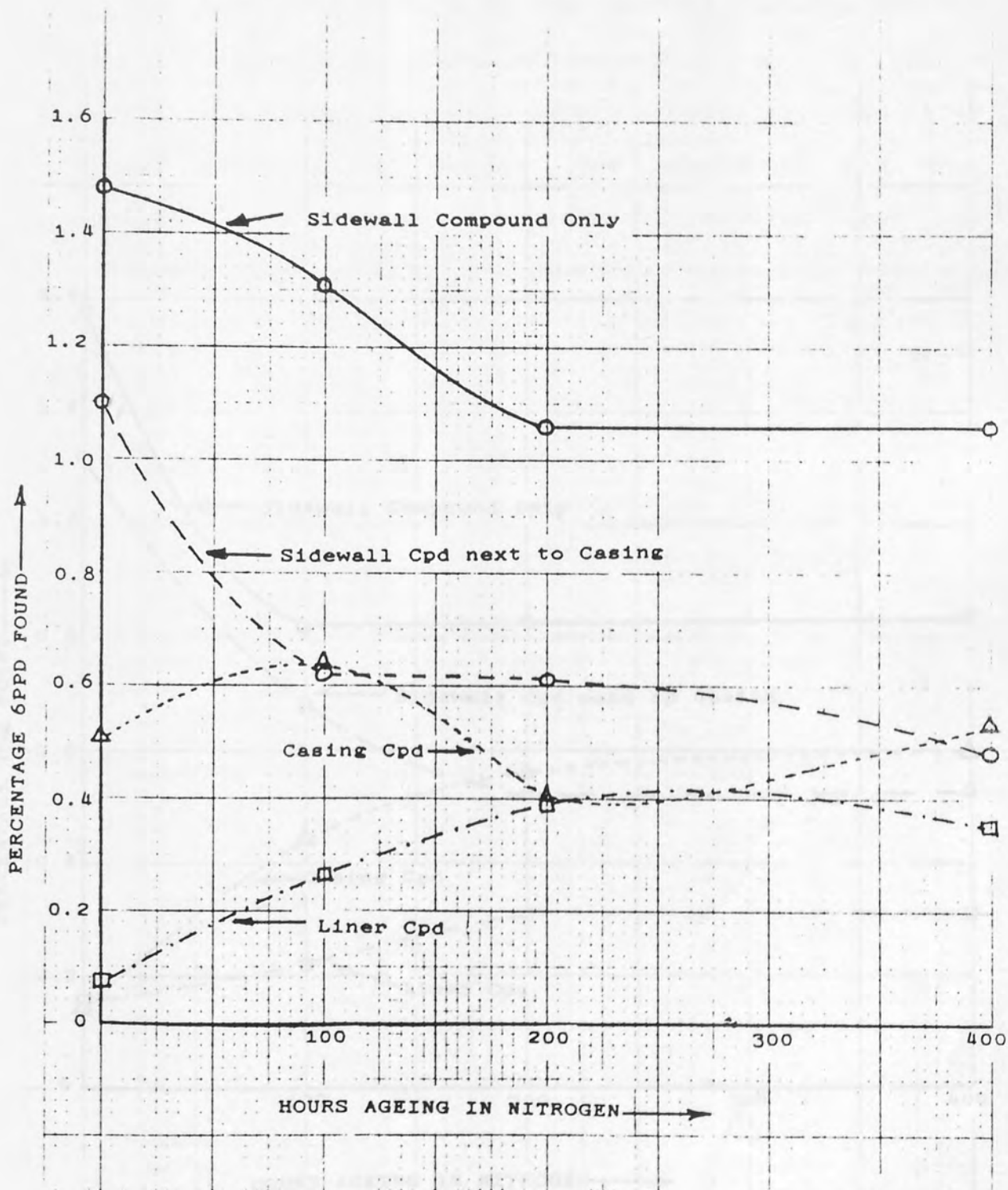
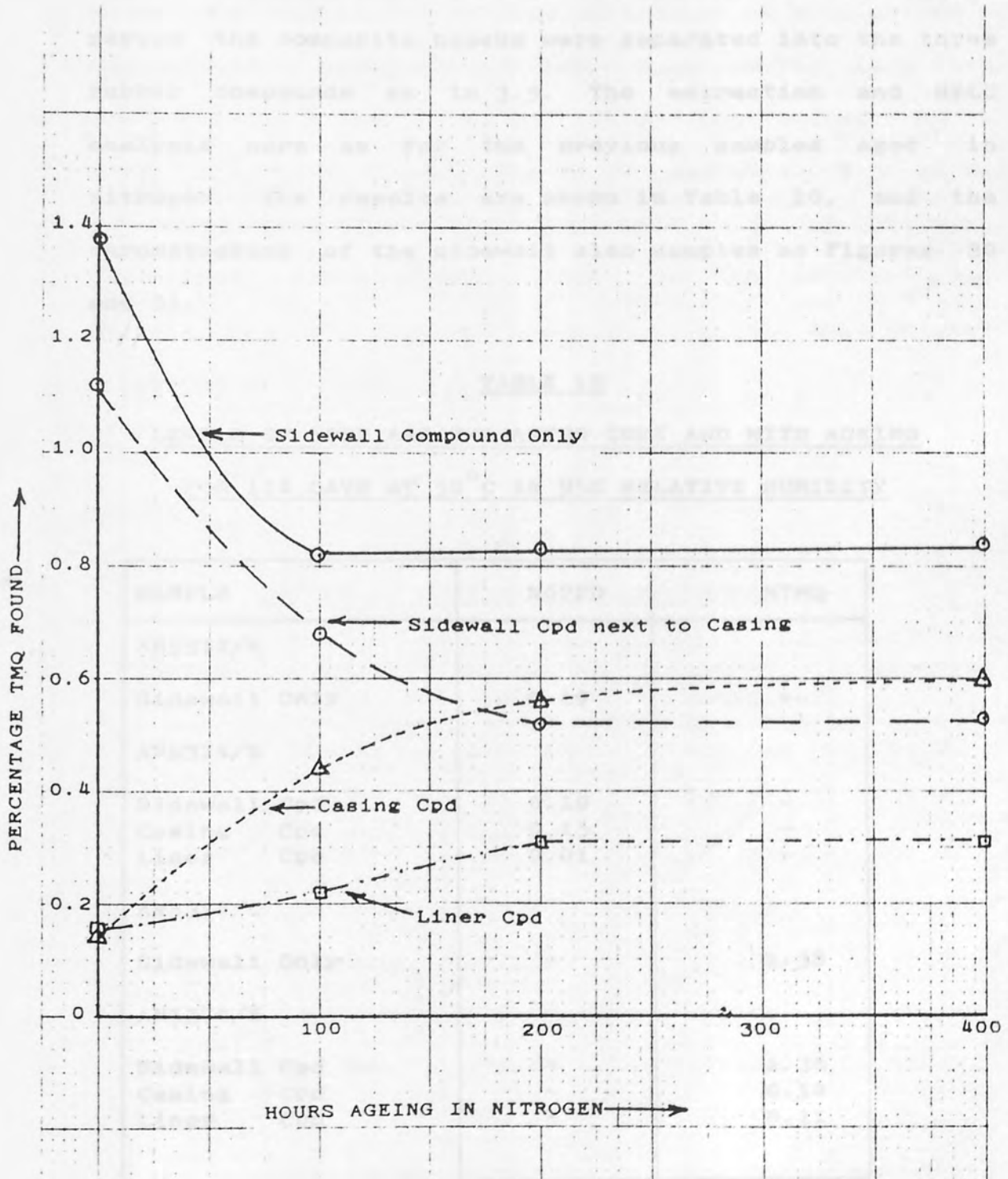

FIGURE 21

MIGRATION OF TMQ ANTIDEGRADANT WITH NITROGEN AGEING



3.7.2. Samples Aged at 50°C in 95% Relative Humidity

Test pieces of the sidewall compound and the composite blocks were aged at 50°C in 95% relative humidity for 114 days to assess the effect of water. After the ageing period the composite blocks were separated into the three rubber compounds as in 3.5. The extraction and HPLC analysis were as for the previous samples aged in nitrogen. The results are shown in Table 10, and the chromatograms of the sidewall slab samples as Figures 30 and 31.

TABLE 10

LEVELS OF 6PPD-AND TMQ AFTER CURE AND WITH AGEING
FOR 114 DAYS AT 50°C IN 95% RELATIVE HUMIDITY

SAMPLE		%6PPD	%TMQ
AN5374/A			
Sidewall	Only	0.19	-
AN5374/B			
Sidewall	Cpd	0.19	-
Casing	Cpd	0.15	-
Liner	Cpd	0.01	-
AN5374/C			
Sidewall	Only	-	1.38
AN5374/E			
Sidewall	Cpd	-	1.36
Casing	Cpd	-	0.14
Liner	Cpd	-	0.11

3.7.3. Heat Ageing of 6PPD Antidegradant

In order to assess the effect of heat alone on the antidegradant, 0.1g samples were accurately weighed and placed into glass tubes of about 5cm³ capacity. The tubes were then sealed, placed upright in an oven at 100°C and removed at intervals of time. When removed, each tube was cooled, broken open and the contents washed into a 100cm³ volumetric flask using dichloromethane. 4cm³ of 2-butanone was added and the volume made up to the mark with 2-propanol. After mixing, 10µl of the solution was injected into the HPLC and analysed using the same solvent programme as before.

The results are shown in Table 11.

TABLE 11

EFFECT OF HEAT ON 6PPD ANTIDEGRADANT

SAMPLE	TIME AT 100°C	INITIAL WT (mg)	AMOUNT FOUND (mg)	% RECOVERY
1	24hrs	114.75	114.62	99.9
2	2 days	89.00	90.19	101.3
3	4 days	84.25	82.47	97.9
4	30 days	68.80	66.21	96.2
5	61 days	77.57	74.75	96.4
6	220 days	99.48	95.60	96.1
7	400 days	85.83	82.40	96.0
8	730 days	72.15	69.41	96.2

Example chromatograms from the above experiment are shown as Figures 30 and 31.

3.8. Conclusions

3.8.1. Nitrogen Ageing

The original amount of antidegradant added to the sidewall compounds was 1.75%. Immediately after vulcanisation this value had fallen to 1.48% 6PPD and 1.38% TMQ in their respective sidewall slabs. This could have been due either to volatile loss at the vulcanisation temperature or possibly a reaction with the polymer chains so that the antidegradants became 'network bound' and hence not extractable in the solvent system used.

In the composite blocks, the 6PPD appeared to have a greater initial rate of migration (36% had migrated into the casing and liner compounds) than the TMQ where only 21% had migrated into the casing and liner compounds. The difference in the levels of antidegradants between the sidewall slabs and the composite blocks is difficult to explain. As the sidewall slabs were made up with only one rubber compound, the available surface area for volatile loss was greater by a factor of two over the sidewall compound in the composite blocks, where one side was adjacent to the casing compound. The concentration of antidegradant would have been the same at all surfaces and a higher loss would have been expected from the sidewall slab. The loss of 6PPD from the sidewall slab was 0.27% and that from the composite block 0.07% which fits the

above theory. However, the loss of TMQ from its sidewall slab was 0.37%, whereas the loss from the composite block (0.34%) was almost the same, so the theory of higher surface areas giving higher losses does not apply for TMQ. The answer may lie in the relative volatilities of the two antidegradants and the rate at which migration takes place. The slower migration rate of TMQ would leave a higher concentration of the antidegradant in the sidewall compound layer and possibly a greater loss of TMQ may take place at the surface of the composite block.

After 100 and 200 hours ageing there were further losses of 6PPD from the sidewall slab but no further loss after that up to 400 hours ageing. TMQ steadies out after 100 hours ageing showing no further losses up to 400 hours, suggesting that TMQ reaches an equilibrium state faster than 6PPD.

In the composite blocks, migration of the antidegradants from the sidewall compound into the casing and liner compounds, continued throughout the whole of the ageing period. None of the samples reached an equilibrium state where equal amounts of antidegradant was present in each of the three layers. In both composite blocks the antidegradant level in the casing compound was higher than that in the sidewall layer after 400 hours ageing. This suggests that, given enough time, migration would continue from the sidewall into the other layers. The total amount of 6PPD in the composite block continued to fall with

ageing from an initial value of 1.68% to 1.36%. TMQ, however, remained fairly constant at 1.41% to 1.44%. The greater ageing stability and slower rate of migration of TMQ was probably connected with the fact that it is a polymerised product and as such would have a higher overall molecular weight than 6PPD.

3.8.2. Ageing at 95% Relative Humidity

This type of ageing appears, at first sight, to show that 6PPD was lost at a much higher rate than TMQ. Only 0.19% 6PPD was left after 114 days, whereas there was 1.38% TMQ in the sidewall slabs. In the composite blocks the total 6PPD remaining was 0.35% while the total TMQ was 1.61% showing that very little TMQ was lost. p-phenylenediamine type antidegradants are generally very soluble in water and it is possible that 6PPD was leached out of the rubber compounds during the ageing period. However, the sidewall slab and the composite block containing 6PPD were placed in an ozone cabinet after the 114 days ageing. If the levels of antidegradant were really as low as the results suggest, the ozone cracking would occur within a short time. Under the conditions of 50 parts per hundred million ozone at 38°C, the samples showed no evidence of cracking after two years exposure. The likely explanation of this surprising result is that the 6PPD has become chemically bonded to the rubber network and was no longer extractable with solvents, although it is still capable of giving adequate protection.

3.8.3. Heat Ageing

The 0.1g samples of 6PPD which had been sealed into small glass tubes in an atmosphere of air, then heated at 100°C for up to 730 days, showed on analysis that the antidegradant is very stable to heat. Therefore the losses of 6PPD from the rubber compounds is not due to heat degradation. Other factors as discussed above are more likely causes of the fall-off in the amount recovered from the rubber compounds.

The overall conclusion is that antidegradants do migrate through rubber compounds, from areas of high concentration to areas of low concentration. Initial migration rates are high, but slow down with time although it is unlikely that true equilibrium conditions are ever achieved. Migration, water leaching, volatile losses at high temperatures and chemical combination with the polymer network, all play a part during the life of a tyre in determining whether the original antidegradant system was good enough to prevent degradation and cracking.

3.9.HPLC CHROMATOGRAMS

3.9.1. Ageing in Nitrogen - Initial Samples

FIGURE 22

AN5374/A SIDEWALL SLAB

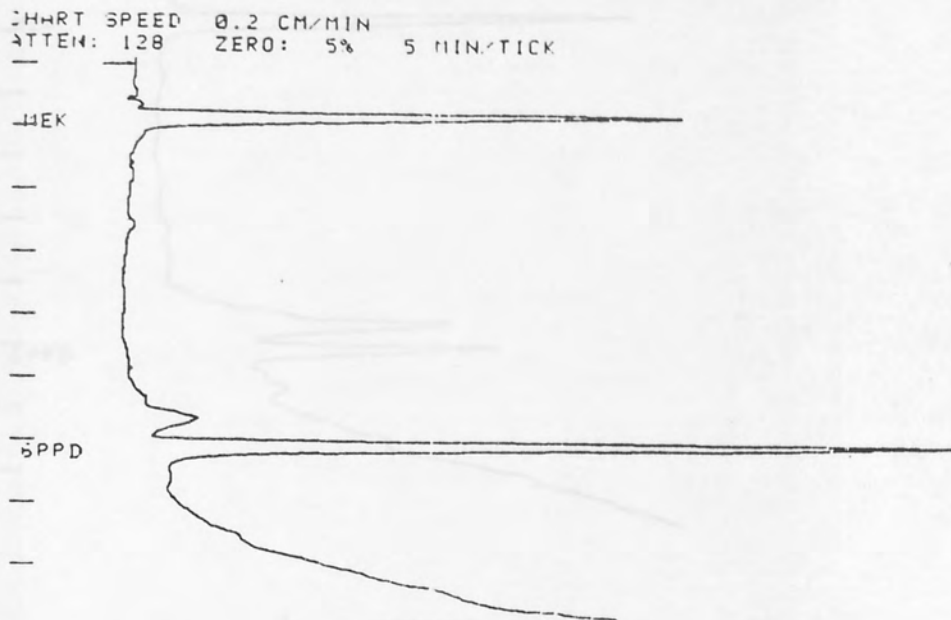

FIGURE 23

AN5374/B SIDEWALL FROM COMPOSITE BLOCK

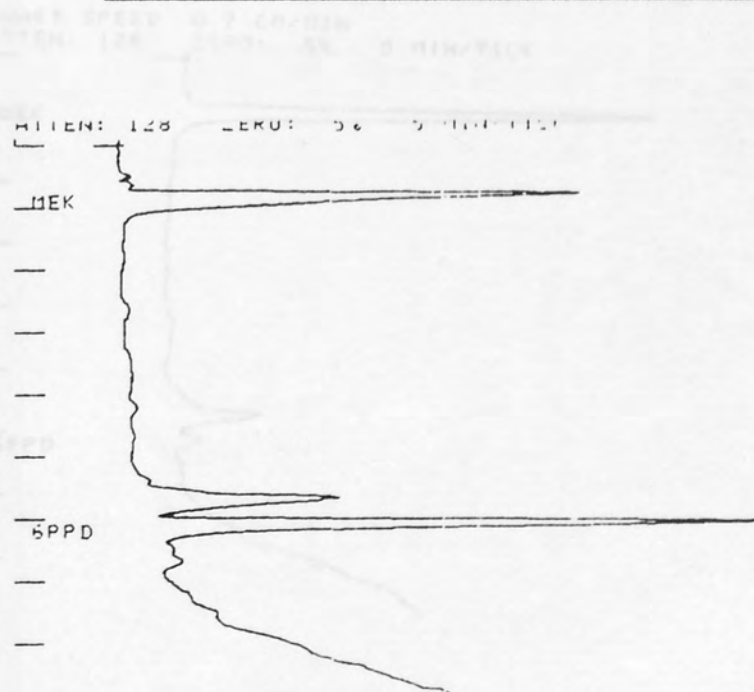

FIGURE 24

AN5374/B CASING FROM COMPOSITE BLOCK

CHART SPEED 0.2 CM/MIN
ATTEN: 128 ZERO: 5% 5 MIN/TICK

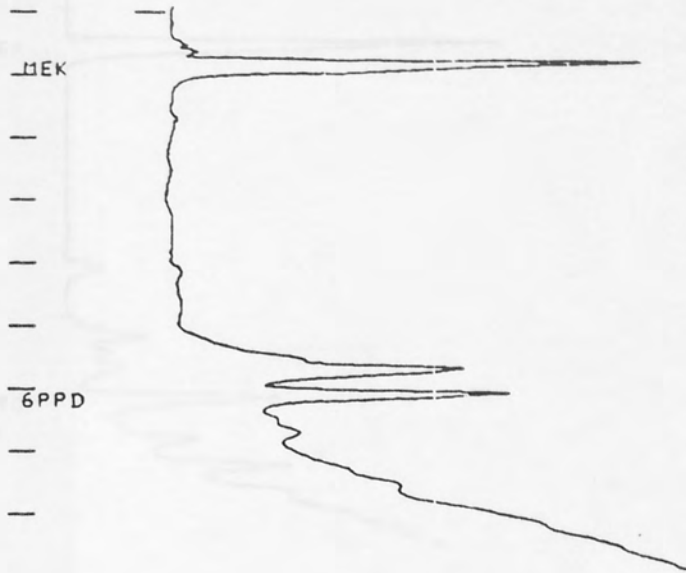

FIGURE 25

AN5374/B LINER FROM COMPOSITE BLOCK

AN5374/B BLINDWALL FROM COMPOSITE BLOCK

CHART SPEED 0.2 CM/MIN
ATTEN: 128 ZERO: 5% 5 MIN/TICK



FIGURE 26

AN5374/C SIDEWALL SLAB

CHART SPEED 0.2 CM/MIN
ATTEN: 128 ZERO: 5% 5 MIN. TICK

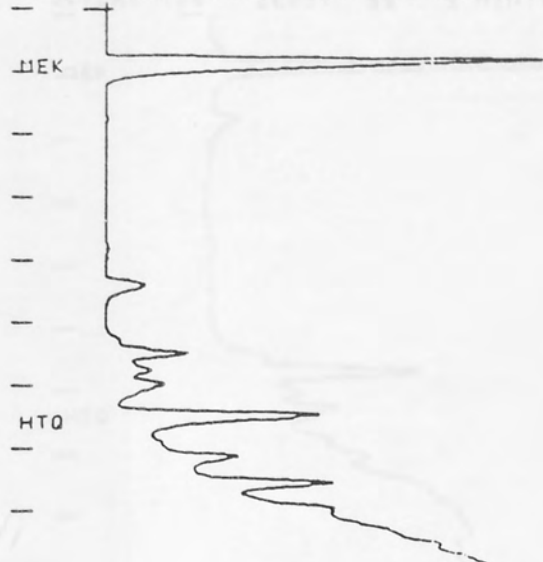
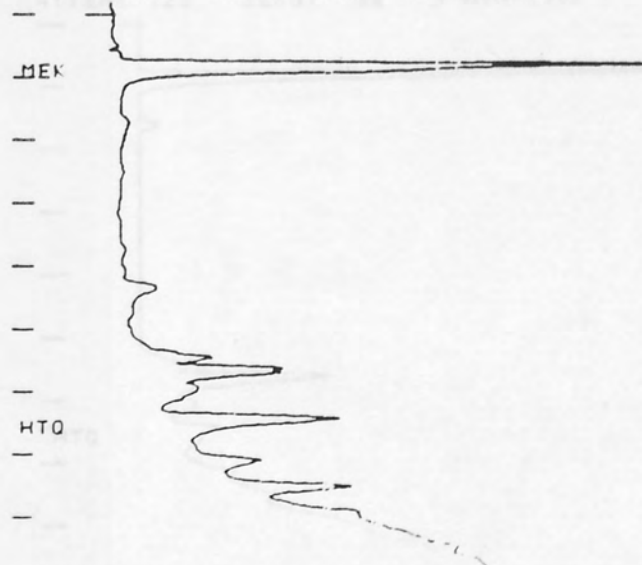

FIGURE 27

AN5374/D SIDEWALL FROM COMPOSITE BLOCK

CHART SPEED 0.2 CM/MIN
ATTEN: 128 ZERO: 5% 5 MIN. TICK



AN5374/D CASING FROM COMPOSITE BLOCK

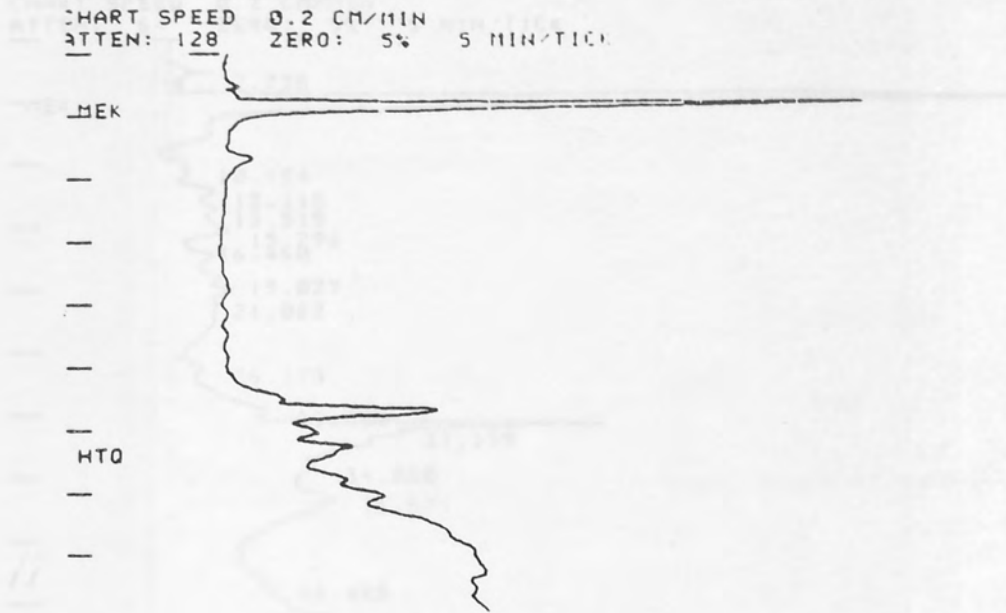
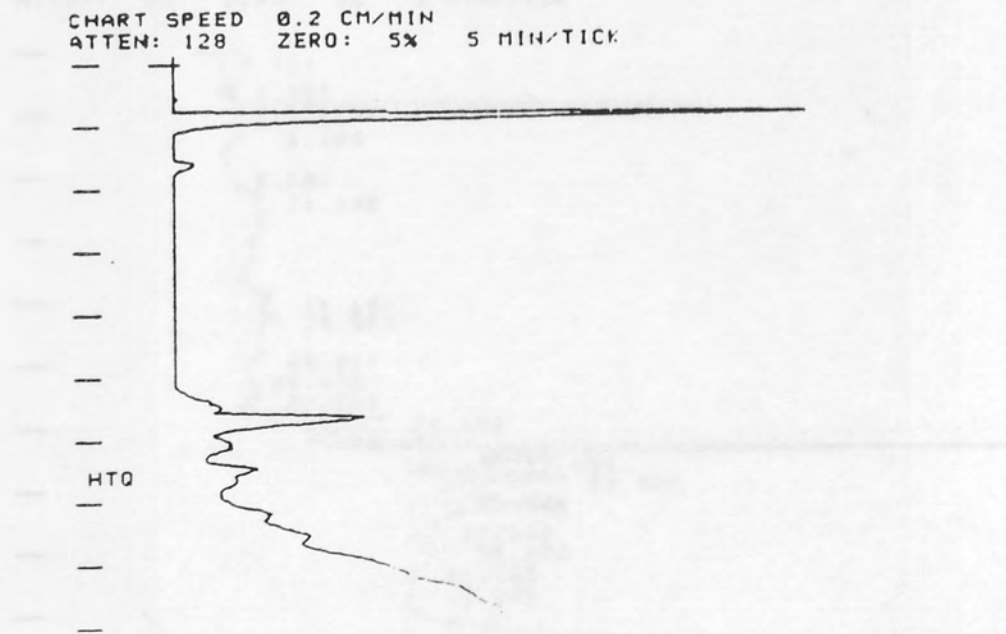

FIGURE 29

AN5374/D LINER FROM COMPOSITE BLOCK



3.9.2. Samples Aged in 95% Relative Humidity

FIGURE 30

AN5374/A SIDEWALL SLAB

CHART SPEED 0.2 CM/MIN
ATTEN: 64 ZERO: 5% 5 MIN/TICK

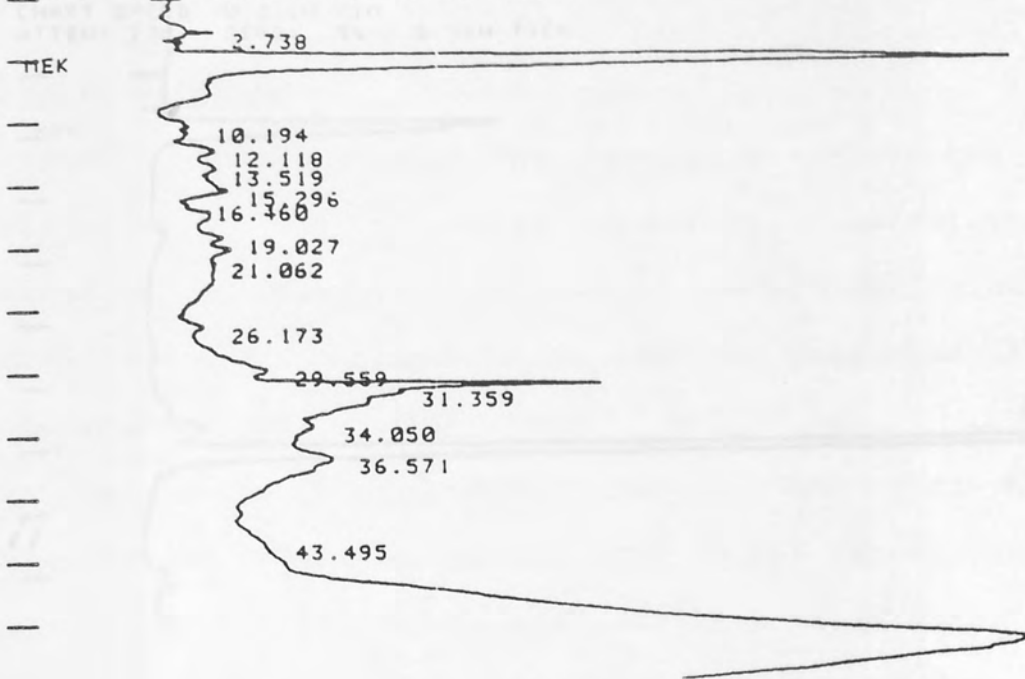
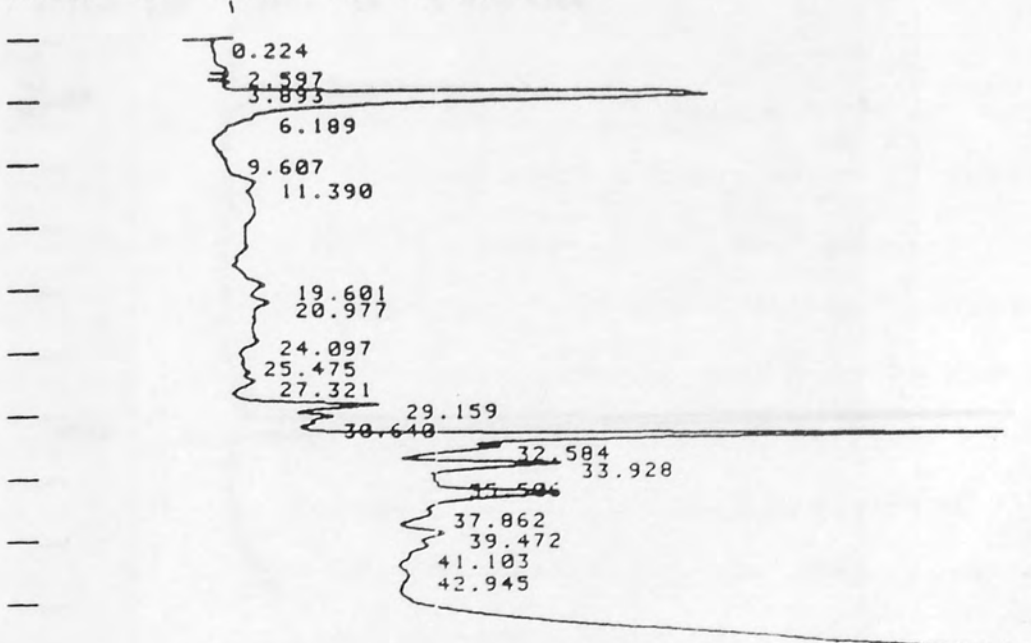

FIGURE 31

AN5374/C SIDEWALL SLAB

CHART SPEED 0.2 CM/MIN
ATTEN: 64 ZERO: 5% 5 MIN/TICK



3.9.3. 6PPD Antidegradant Aged at 100°C

FIGURE 32

6PPD AGED FOR 4 DAYS

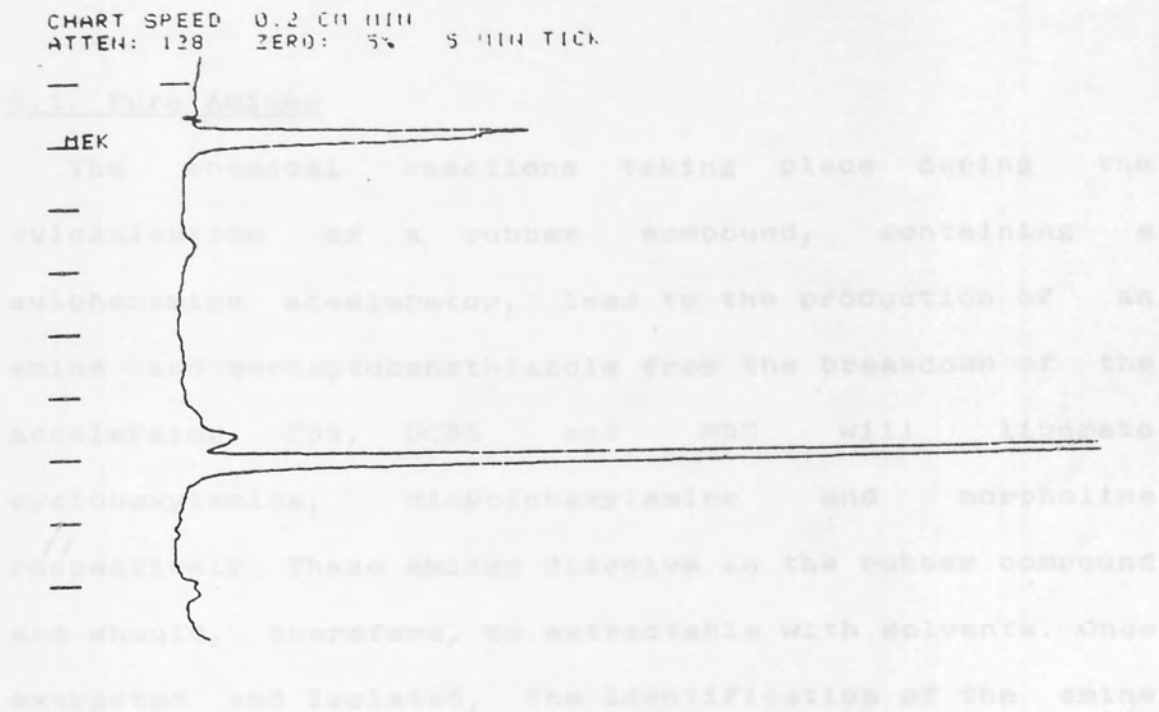
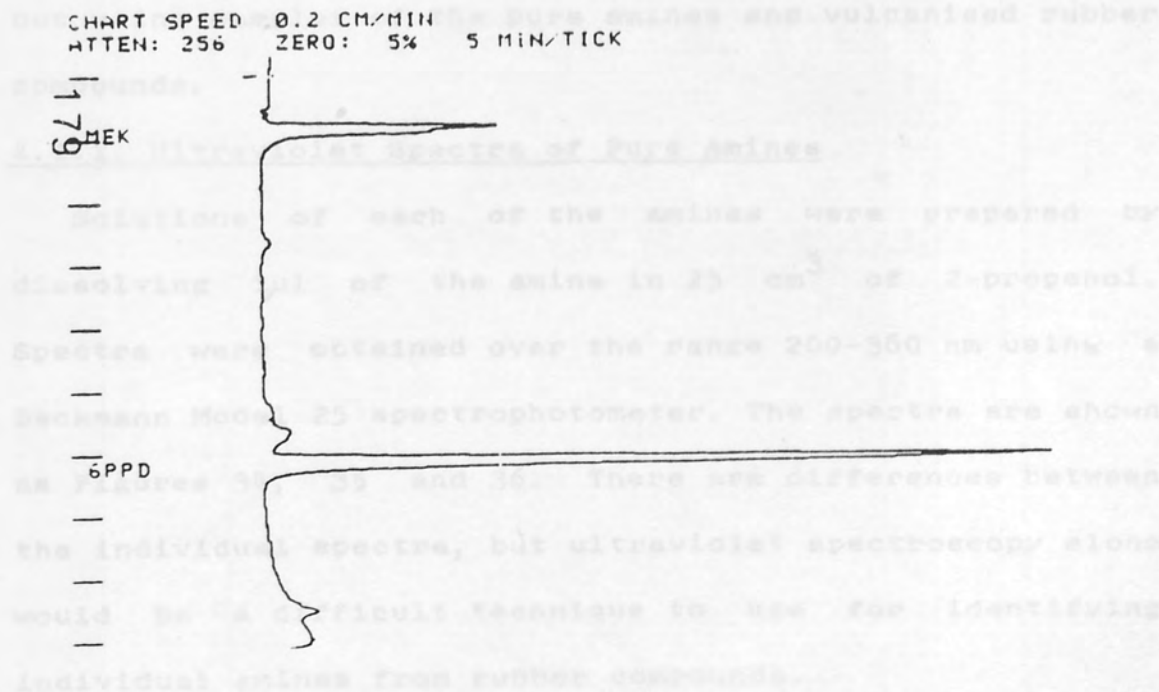

FIGURE 33

6PPD AGED FOR 400 DAYS



CHAPTER 4

ANALYTICAL METHOD FOR THE DETERMINATION OF

SULPHENAMIDE ACCELERATORS

4.1. Pure Amines

The chemical reactions taking place during the vulcanisation of a rubber compound, containing a sulphenamide accelerator, lead to the production of an amine and mercaptobenzthiazole from the breakdown of the accelerator. CBS, DCBS and MBS will liberate cyclohexylamine, dicyclohexylamine and morpholine respectively. These amines dissolve in the rubber compound and should, therefore, be extractable with solvents. Once extracted and isolated, the identification of the amine would allow identification of the original sulphenamide used. To this end, the following experiments were carried out using samples of the pure amines and vulcanised rubber compounds.

4.1.1. Ultraviolet Spectra of Pure Amines

Solutions of each of the amines were prepared by dissolving 1 μ l of the amine in 25 cm³ of 2-propanol. Spectra were obtained over the range 200-360 nm using a Beckmann Model 25 spectrophotometer. The spectra are shown as Figures 34, 35 and 36. There are differences between the individual spectra, but ultraviolet spectroscopy alone would be a difficult technique to use for identifying individual amines from rubber compounds.

FIGURE 34

ULTRAVIOLET SPECTRUM OF CYCLOHEXYLAMINE

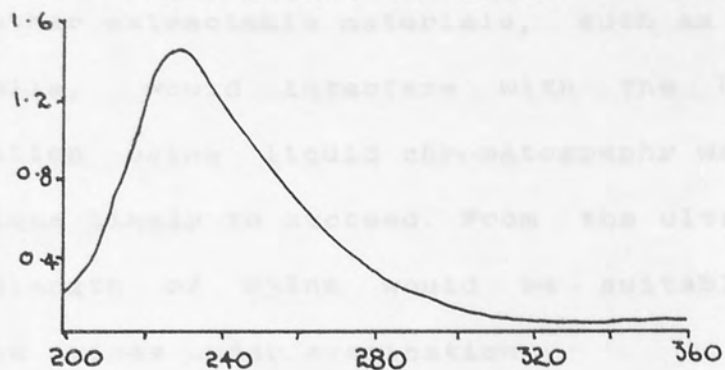

FIGURE 35

ULTRAVIOLET SPECTRUM OF MORPHOLINE

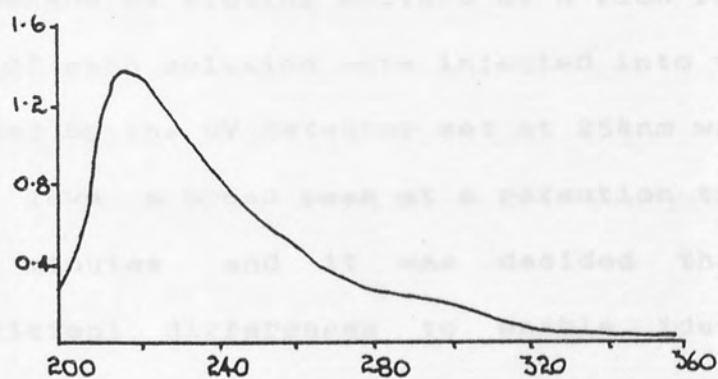
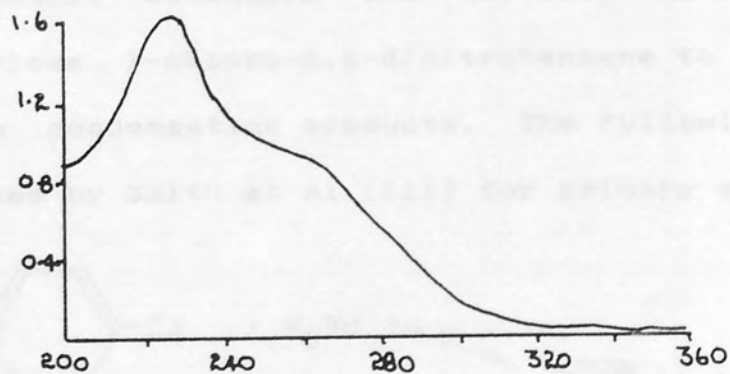

FIGURE 36

ULTRAVIOLET SPECTRUM OF DICYCLOHEXYLAMINE



The other extractable materials, such as antidegradants and oils, would interfere with the UV spectrum so separation using liquid chromatography was chosen as a technique likely to succeed. From the ultraviolet spectra, a wavelength of 254nm would be suitable for detecting all the amines under examination.

4.1.2. Liquid Chromatography of Pure Amines

For the separation of amines by HPLC, a 30cm MicroPak NH₂-10 (aminopropyl bonded phase) column was used with cyclohexane as eluting solvent at a flow rate of 1cm³/min. 10µl of each solution were injected into the column and detected by the UV detector set at 254nm wavelength. Each amine gave a broad peak at a retention time of 10.9 to 11.9 minutes and it was decided that there were insufficient differences to enable identification of individual amines. A more likely approach would be to convert the amines into a series of derivatives which may show differences.

4.2. 1-chloro-2,4-dinitrobenzene Derivatives

Primary, secondary and tertiary amines react with colourless 1-chloro-2,4-dinitrobenzene to yield intense yellow condensation products. The following reaction was proposed by Smith et al (111) for primary amines:-

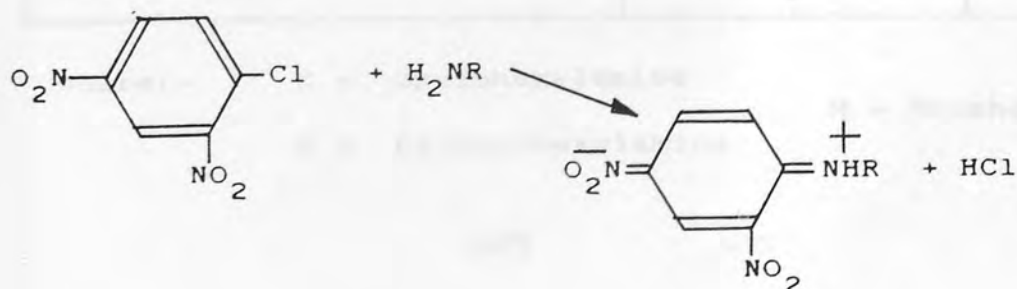

Secondary and tertiary amines react similarly. Because it was anticipated that small quantities of amines would be present in vulcanised rubber compounds, it was thought that the production of intense yellow derivatives would enhance the sensitivity of the method.

4.2.1. Procedure

Reagent :- 2% 1-chloro-2,4-dinitrobenzene in diethyl ether

0.01g of amine was weighed into a small vial, 1cm³ of the reagent added, the vial was capped and then shaken. The solution turned yellow.

4.2.2. Thin Layer Chromatography

5 microlitre samples of each of the amine derivatives were spotted on to a high performance thin layer plate and eluted with various solvents. The results are shown in Table 12.

TABLE 12

R_f VALUES OF AMINE DERIVATIVES USING VARIOUS SOLVENTS

Eluting Solvents	R _f Values		
	C	D	M
Methylene Chloride	0.62	0.58	0.65
Cyclohexane/2-propanol (3:1 v/v)	0.52	0.45	0.21
Acetonitrile	0.75	0.63	0.68

where:-

C = Cyclohexylamine

M = Morpholine

D = Dicyclohexylamine

The results in Table 12 show that the amine derivatives can be separated by chromatography. Thin Layer is not, however, an accurate quantitative technique and in order to determine amine amounts, HPLC was to be tried.

4.2.3. Visible Light Spectroscopy

Before any work could be carried out using HPLC, it was necessary to determine a suitable wavelength where the absorption of the amine derivatives was at a maximum. Using the Beckmann spectrophotometer, spectra of the derivatives were obtained over the range 350 - 750 nm. Maximum absorbance of the derivatives was exhibited at 355nm.

4.2.4. Liquid Chromatography of Amine Derivatives

Several solvent programmes were examined to determine which gave a reasonably short retention time with good resolution. The column used was a reverse phase (octadecyl silane) system so that acetonitrile/water solvent mixtures could be used, as TLC had shown that acetonitrile would separate the amine derivatives. The detector wavelength was set at 355nm and the morpholine derivative was used to determine the most satisfactory eluting solvent. The results are shown in Table 13.

TABLE 13

LIQUID CHROMATOGRAPHY OF THE MORPHOLINE DERIVATIVE

Solvent System (All v/v with water)	Retention Times (min)
1. Acetonitrile - isocratic	2.9 3.1
2. 20% acetonitrile to 100% in 16 minutes	12.3
3. 20% acetonitrile for 5 min then to 40% in 10 min. Held at 40% for 10 min.	22.7 23.2
4. 30% acetonitrile to 35% in 5 min. Then to 40% in 5 min. Held at 40%.	17.4
5. 40% acetonitrile - isocratic	9.3 9.9

The 40% acetonitrile gave good resolution with a reasonably short retention time. Some solvent systems gave one peak and others two peaks. There were obviously two distinct species in the solution and the lower hydrophobic solvent systems, i.e. 1, 3 and 5 were able to separate them, whereas the more hydrophobic solvents i.e. 2 and 4 were not. The peaks at 11.9 and 12.6 minutes were common to both cyclohexylamine and dicyclohexylamine, possibly due to a breakdown of the dicyclohexylamine to give some cyclohexylamine. The peak at 1.9 minutes was probably the dicyclohexylamine form. The complete results are shown in Table 14 and the chromatograms as Figures 37, 38 and 39.

TABLE 14

LIQUID CHROMATOGRAPHY OF AMINE DERIVATIVES

Amine Derivative	Retention Time (min)		
Morpholine	9.3	9.9	
Cyclohexylamine		11.9	12.6
Dicyclohexylamine	1.9	11.9	12.6

FIGURE 37

CHROMATOGRAM OF MORPHOLINE DERIVATIVE

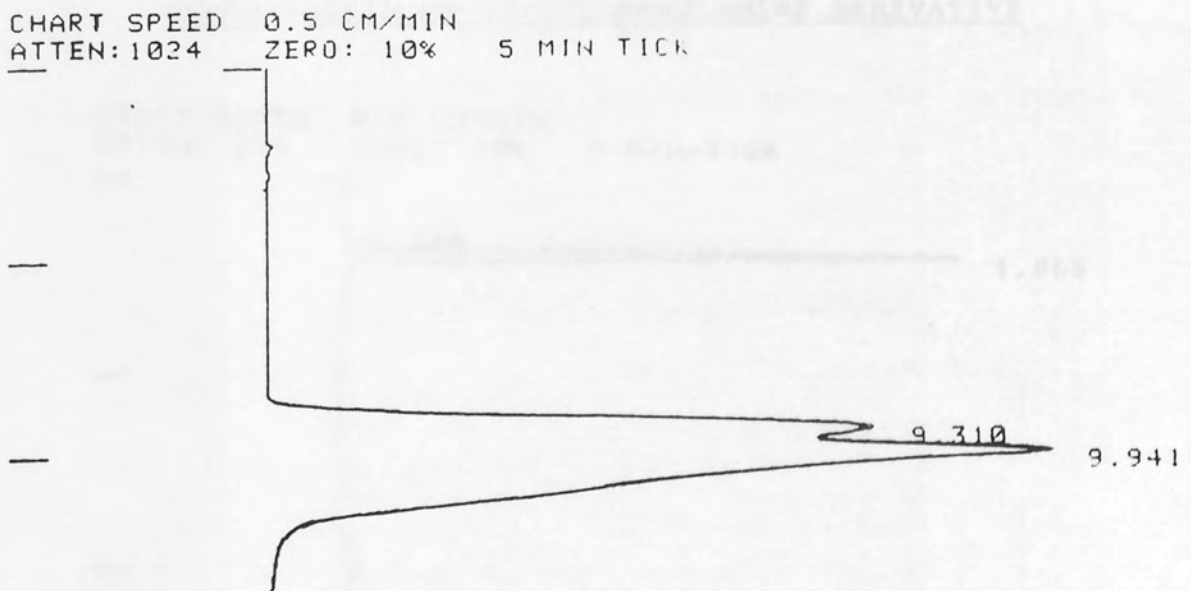

FIGURE 38

CHROMATOGRAM OF CYCLOHEXYLAMINE DERIVATIVE

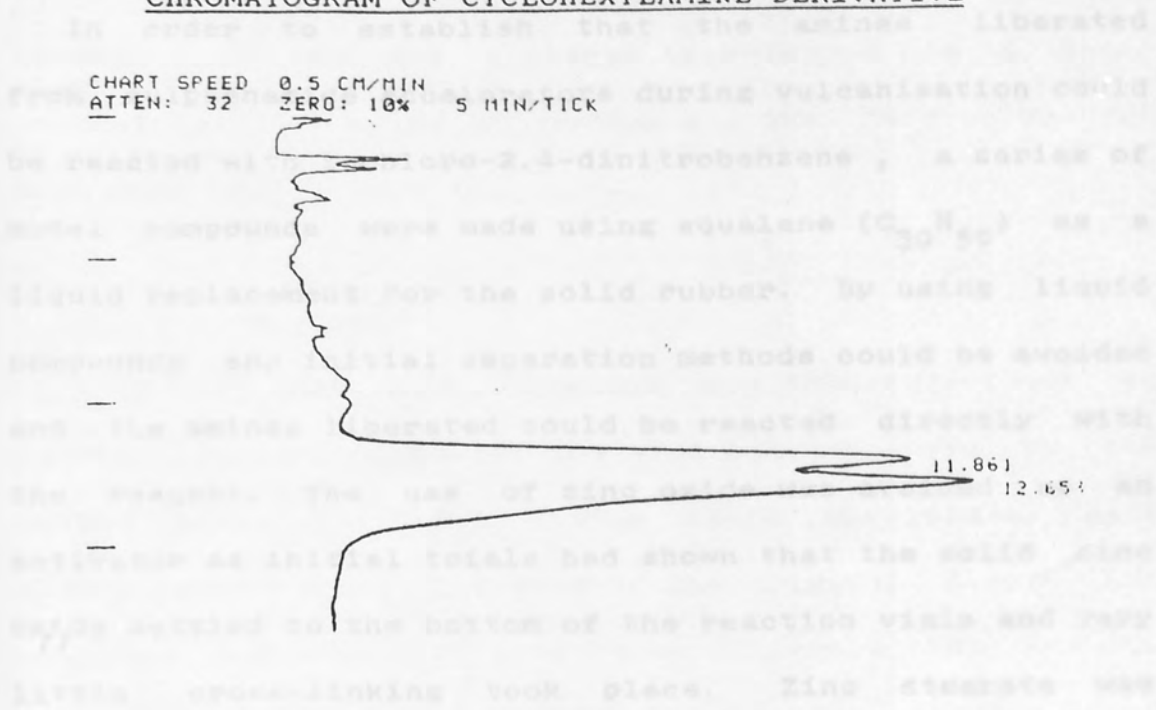
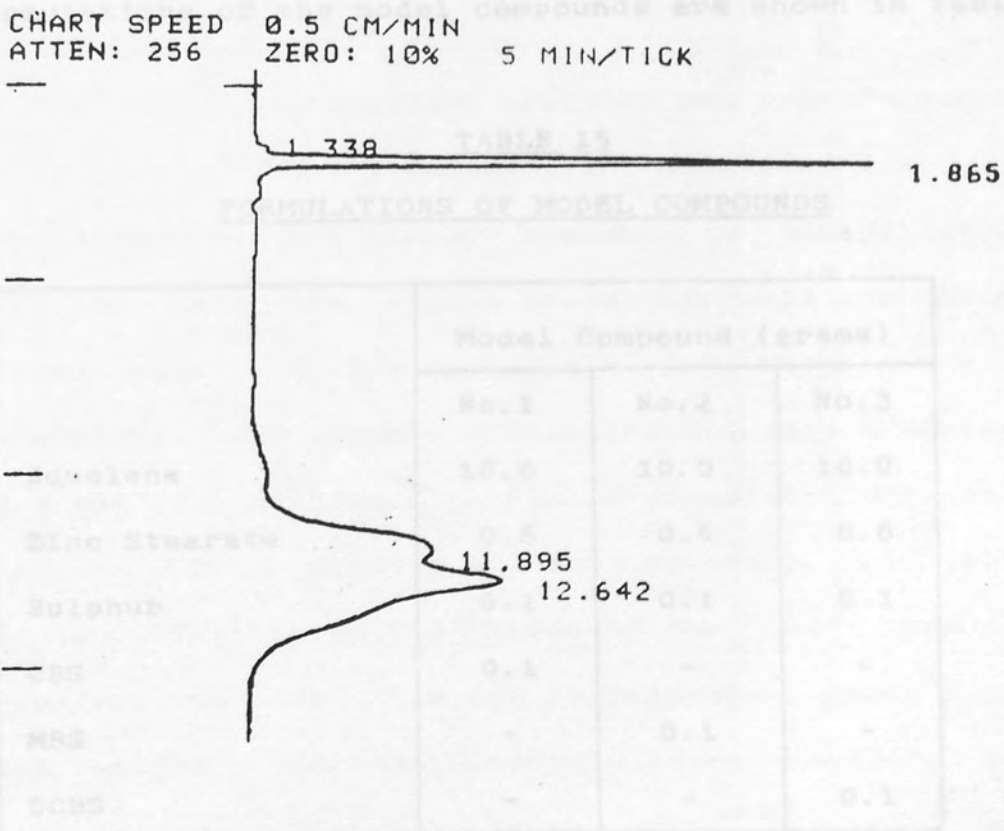

FIGURE 39

CHROMATOGRAM OF DICYCLOHEXYLAMINE DERIVATIVE



4.3. Model Compound Systems

In order to establish that the amines liberated from sulphenamide accelerators during vulcanisation could be reacted with 1-chloro-2,4-dinitrobenzene, a series of model compounds were made using squalene ($C_{30}H_{50}$) as a liquid replacement for the solid rubber. By using liquid compounds any initial separation methods could be avoided and the amines liberated could be reacted directly with the reagent. The use of zinc oxide was avoided as an activator as initial trials had shown that the solid zinc oxide settled to the bottom of the reaction vials and very little cross-linking took place. Zinc stearate was therefore chosen as the activator, although it had to be used at a much higher loading than zinc oxide. The formulations of the model compounds are shown in Table 15.

TABLE 15
FORMULATIONS OF MODEL COMPOUNDS

	Model Compound (grams)		
	No.1	No.2	No.3
Squalene	10.0	10.0	10.0
Zinc Stearate	0.6	0.6	0.6
Sulphur	0.1	0.1	0.1
CBS	0.1	-	-
MBS	-	0.1	-
DCBS	-	-	0.1

Each model compound was placed in a sealed tube and heated at 160°C for 2 hours. The tubes were then cooled, broken open and the contents transferred to a 25cm³ volumetric flask using chloroform and then made up to the mark with chloroform.

4.3.1. HPLC Analysis

10µl of each model compound were injected into the reverse phase column of the HPLC and analysed by the method given in 2.1.1. using 254nm wavelength. Each chromatogram showed that none of the original accelerator remained, but that both mercaptobenzthiazole (MBT) and its disulphide (MBTS) were present, indicating that the amine had been released.

4.3.2. Amine Derivatives

5cm³ of the chloroform solution was transferred to a vial, 1cm³ of the 1-chloro-2,4 - dinitrobenzene solution was added and the mixture shaken. 10 microlitres were injected into the reverse phase column of the HPLC and eluted with 40% acetonitrile : 60% water with 355nm wavelength. The sample containing CBS gave a doublet at 10.3 and 10.8 minutes. The sample containing DCBS gave one peak at 2.0 minutes and another sharp peak at 10.8 minutes. The retention times of the major peaks were therefore earlier than the corresponding peaks from the pure amines. The sample containing MBS however, gave a small peak at 9.8 minutes and an unresolved large doublet

at 12.5 minutes, which was considerably different from that given by the pure amine but still satisfactory for differentiating between the sulphenamides. These differences must be due to the change in the matrix from pure amines to the model compound formulation where the amines are produced from decomposition by heat and pressure.

FIGURE 40

CHROMATOGRAM OF DERIVATIVE OF CBS FROM MODEL COMPOUND

73



FIGURE 41

CHROMATOGRAM OF DERIVATIVE OF DCBS FROM MODEL COMPOUND

CHART SPEED 0.5 CM/MIN
ATTEN: 256 ZERO: 5% 5 MIN/TICK

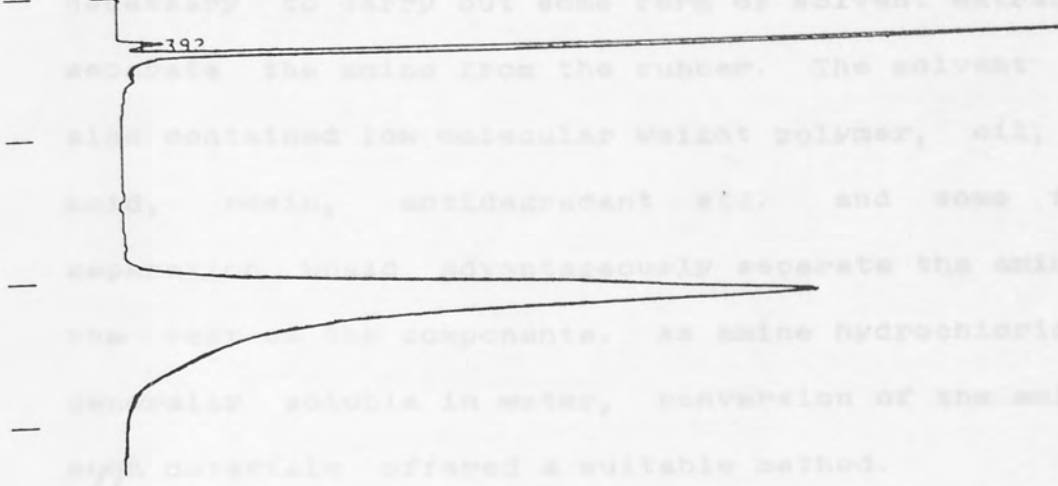
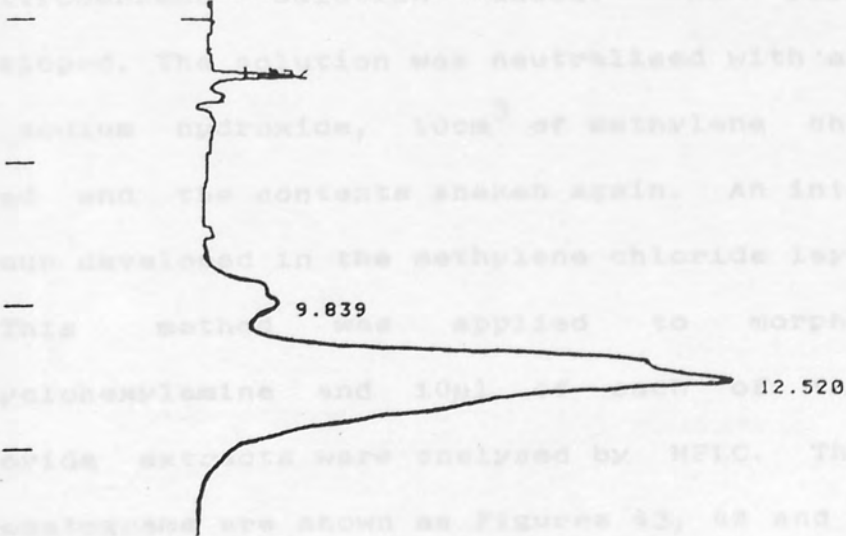

FIGURE 42

CHROMATOGRAM OF DERIVATIVE OF MBS FROM MODEL COMPOUND

CHART SPEED 0.5 CM/MIN
ATTEN: 128 ZERO: 10% 5 MIN/TICK



4.4. Cured Rubber Compounds

To analyse for amines in cured rubber compounds it was necessary to carry out some form of solvent extraction to separate the amine from the rubber. The solvent extract also contained low molecular weight polymer, oil, stearic acid, resin, antidegradant etc. and some form of separation would advantageously separate the amine from the rest of the components. As amine hydrochlorides are generally soluble in water, conversion of the amines to such materials offered a suitable method.

4.4.1. Amine Hydrochlorides

100 μ l of cyclohexylamine were transferred to a separating funnel, 25cm³ distilled water and 1cm³ of a 1M solution of hydrochloric acid were then added. The contents were shaken and 1cm³ of the 2% 1-chloro-2,4-dinitrobenzene solution added. No yellow colour developed. The solution was neutralised with a 1M solution of sodium hydroxide, 10cm³ of methylene chloride were added and the contents shaken again. An intense yellow colour developed in the methylene chloride layer.

This method was applied to morpholine and dicyclohexylamine and 10 μ l of each of the methylene chloride extracts were analysed by HPLC. The resulting chromatograms are shown as Figures 43, 44 and 45.

FIGURE 43

CYCLOHEXYLAMINE DERIVATIVE FROM AMINE HYDROCHLORIDE

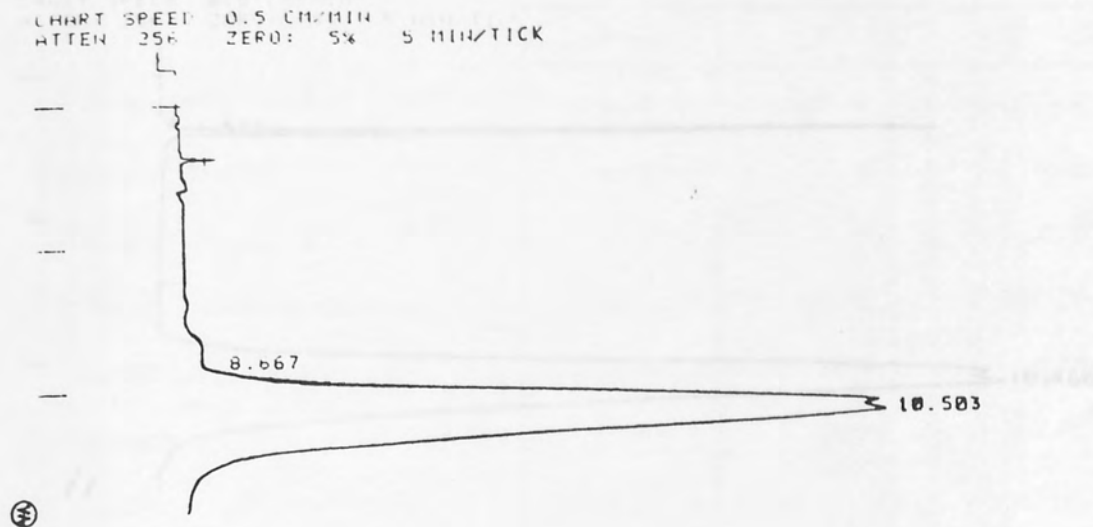

FIGURE 44

MORPHOLINE DERIVATIVE FROM AMINE HYDROCHLORIDE

61

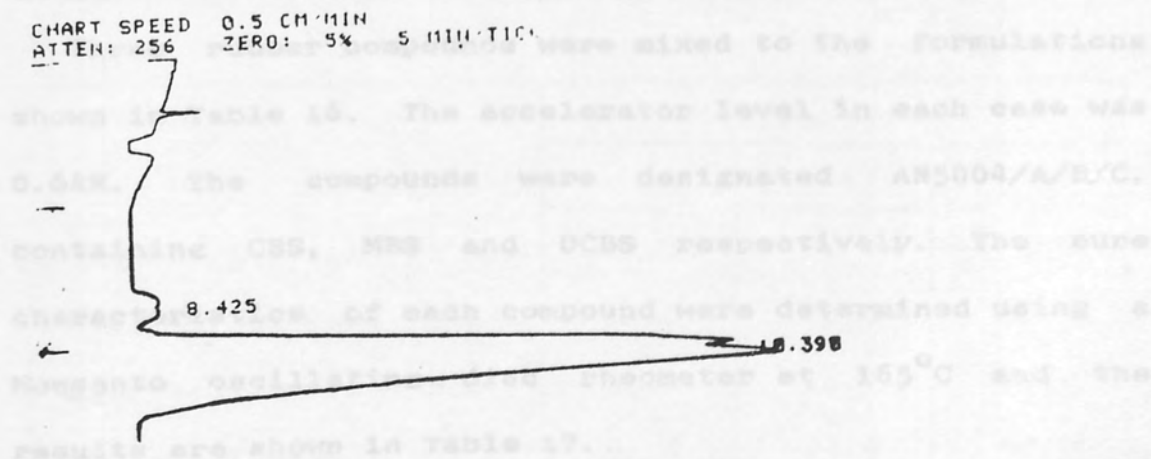
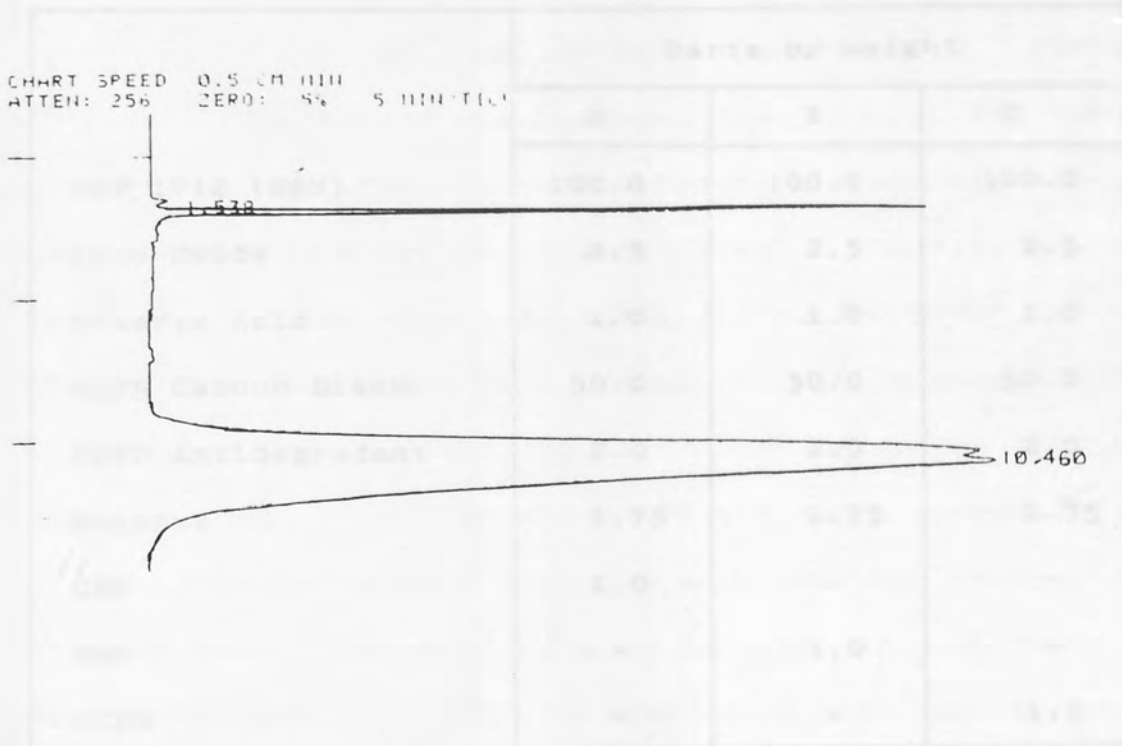

FIGURE 45

DICYCLOHEXYLAMINE DERIVATIVE FROM AMINE HYDROCHLORIDE



The results were similar to those obtained from the model compounds, so it was decided to examine some laboratory made rubber compounds.

4.4.2. Laboratory Mixed Compounds

Three rubber compounds were mixed to the formulations shown in Table 16. The accelerator level in each case was 0.64%. The compounds were designated AN5004/A/B/C. containing CBS, MBS and DCBS respectively. The cure characteristics of each compound were determined using a Monsanto oscillating disc rheometer at 165°C and the results are shown in Table 17.

TABLE 16

FORMULATIONS OF RUBBER COMPOUNDS

	Parts by weight		
	A	B	C
OEP, 1712 (SBR)	100.0	100.0	100.0
Zinc Oxide	2.5	2.5	2.5
Stearic Acid	1.0	1.0	1.0
N375 Carbon Black	50.0	50.0	50.0
6PPD Antidegradant	2.0	2.0	2.0
Sulphur	1.75	1.75	1.75
CBS	1.0	-	-
MBS	-	1.0	-
DCBS	-	-	1.0

TABLE 17

CURE CHARACTERISTICS OF AN5004 COMPOUNDS

	Compound		
	A	B	C
Scorch Time (min)	4.9	5.7	5.3
Time to 50% cure (min)	7.6	10.0	12.7
Time to 90% cure (min)	11.8	14.7	12.7
Optimum Torque (inch pounds)	61.9	63.5	58.0

4.4.2.1. Analysis for Amines in AN5004 Compound

5g of AN5004/B vulcanised compound was milled into a thin sheet, cut into small pieces and placed into a reflux flask with 120 cm³ of a chloroform/acetone mixture (3:1v/v). The sample was refluxed for 3 hours, the rubber filtered off and the filtrate allowed to evaporate at room temperature to a volume of about 50cm³. The filtrate was then transferred to a separating funnel and 50cm³ 1M HCl added. The contents were shaken for 5 minutes, then allowed to separate and the chloroform layer was run off and discarded. (This should leave the amine hydrochloride in the aqueous phase.) The acid solution was neutralised with 1M NaOH, then 2cm³ of a 1% solution of 1-chloro-2,4-dinitrobenzene in diethyl ether added and the contents shaken. 5cm³ methylene chloride were added and the contents shaken again. After separation, the lower methylene chloride layer was run into a porcelain dish and the extraction with methylene chloride carried out a further two times, adding the lower layer to the porcelain dish in each case. The methylene chloride was allowed to evaporate almost to dryness then transferred quantitatively to a 2cm³ volumetric flask with methylene chloride. 10µl were analysed by liquid chromatography using the 40% acetonitrile/60% water as before. The resulting chromatogram is shown as Figure 46.

The integrated areas gave the following results:-

Peak at 9.8 minutes	1054620
Peak at 12.5 minutes	9300340

FIGURE 46

MORPHOLINE DERIVATIVE FROM AN5004/B COMPOUND

CHART SPEED: 0.5 CM MIN
 ATTEN: 128 DEFO: 10.0 5 MIN/TICK

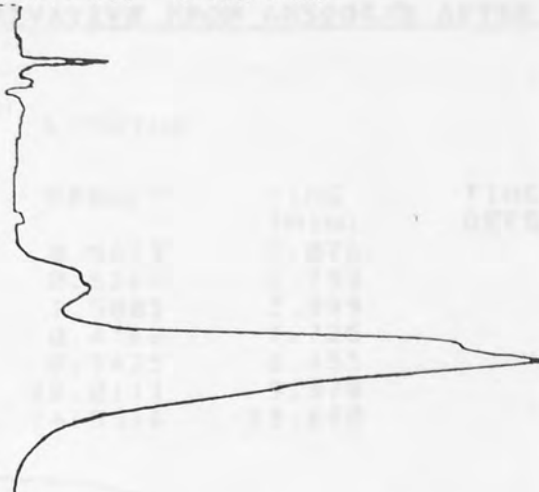

RESULT	TIME (MIN)	TIME OFFSET	AREA COUNTS
9.5567	9.839	-0.001	1054620
84.2772	12.525	-0.005	9300340

In order to assess the possibility of generating the amine hydrochloride directly in the extract, a second sample from AN5004/B was treated in the same way as above, but using a 50% hydrochloric acid solution as the extracting solvent. The extract was neutralised with 20% sodium hydroxide solution before transferring to the separating funnel. The chromatogram is shown in Figure 47.

The chromatogram was similar in shape and the integrated areas are given below:-

Peak at 10 minutes	1335810
Peak at 12. minutes	4524740

The area of the major peak is only about half of that produced from a chloroform/acetone extraction system, probably due to the inability of the aqueous solvent to

swell and penetrate the rubber sample.

FIGURE 47

MORPHOLINE DERIVATIVE FROM AN5004/B AFTER ACID EXTRACTION

SPEED 0.5 CM/MIN
: 128 ZERO: 10% 5 MIN/TICK

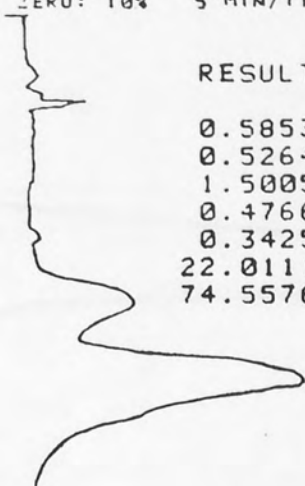

RESULT	TIME (MIN)	TIME OFFSET	AREA COUNTS
0.5853	2.076		35520
0.5264	2.753		31948
1.5005	2.989		91062
0.4766	7.725		28921
0.3425	8.455		20785
22.0111	9.978		1335810
74.5576	12.660		4524740

The test method using chloroform/acetone was used to extract 5g samples of AN5004/A and AN5004/C compounds. The extracts were treated exactly as for AN5004/B to prepare 2cm³ of the derivative solution. The chromatograms are shown as Figures 48 and 49.

FIGURE 48

CYCLOHEXYLAMINE DERIVATIVE FROM AN5004/A COMPOUND

CHART SPEED 0.5 CM/MIN
ATTEN: 256 ZERO: 5% 5 MIN/TICK

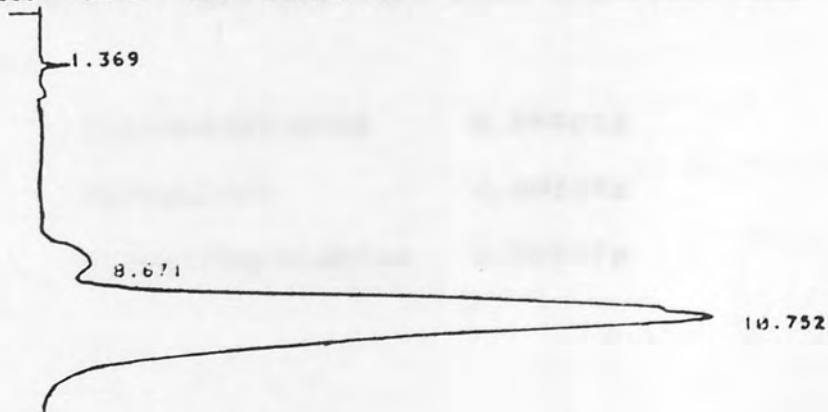
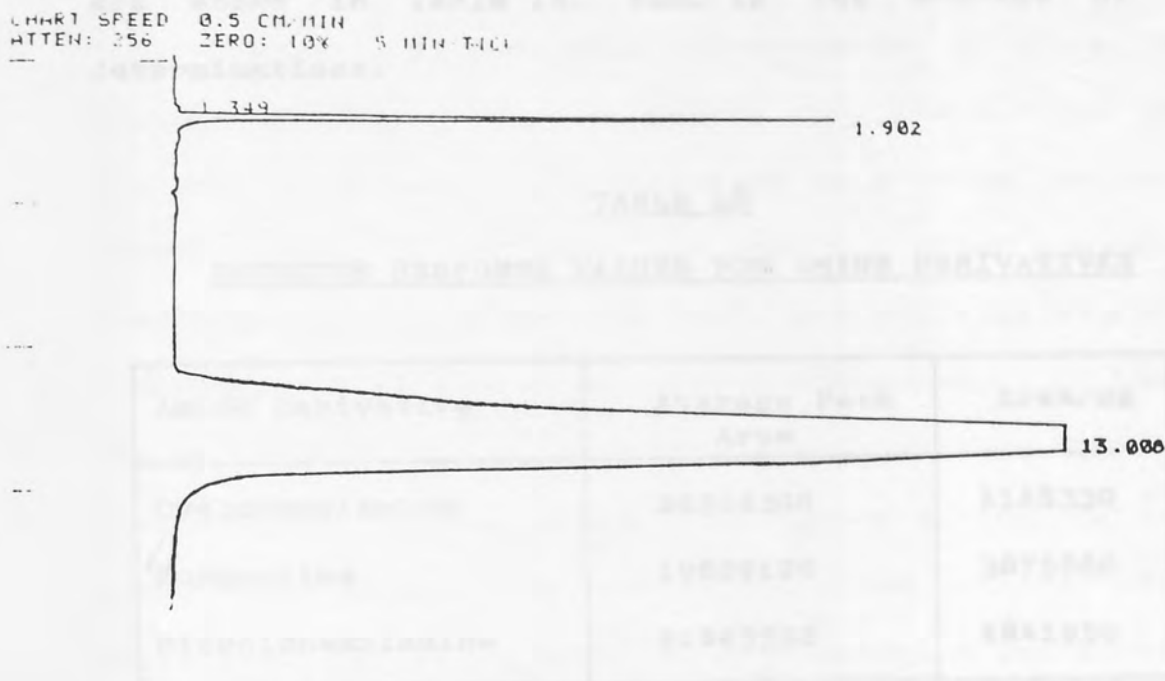

FIGURE 49

DICYCLOHEXYLAMINE DERIVATIVE FROM AN5004/C COMPOUND



4.5. Detector Response Factors for Amine Derivatives

To carry out any quantitative work, the peak area per mg of each amine derivative was required. To ensure complete reaction, it was decided to take 0.05g of 1-chloro-2,4-dinitrobenzene and limit the quantity of amine to about 0.005g, to give a large excess of reagent. In view of the smaller amounts of amine involved, it was also decided to reduce the amounts of acid and alkali to 10cm³ each. Derivatives were produced from the following weights of amines:-

Cyclohexylamine	0.00491g
Morpholine	0.00534g
Dicyclohexylamine	0.00447g

From the resulting chromatograms, the areas of the major peaks were used to calculate the area/mg and these are shown in Table 18. Each is the average of five determinations.

TABLE 18

DETECTOR RESPONSE VALUES FOR AMINE DERIVATIVES

Amine Derivative	Average Peak Area	Area/mg
Cyclohexylamine	20368300	4148330
Morpholine	19629100	3675860
Dicyclohexylamine	21643500	4841950

In 5g of rubber compound from AN5004 the amount of amine generated was twice that used in the above experiment to determine the response values. The high values for the area/mg of each amine indicates that, providing all the amine generated can be extracted, sample sizes could be reduced to 2g while still giving large peak areas.

4.6. Quantitative Analysis of Rubber Compounds

The following weights of rubber compounds were taken:-

	<u>Sample 1</u>	<u>Sample 2</u>
AN5004/A	2.04115g	1.94619g
AN5004/B	1.99932g	1.98353g
AN5004/C	2.16346g	1.97289g

Each of the samples was treated as follows:-

The sample was milled into a thin sheet and wrapped in filter paper. It was then extracted for 16 hours in a Soxhlet apparatus using chloroform/acetone mixture (3:1). The extract was cooled, transferred to a 250cm³ separating funnel, 20cm³ 1M HCl added and shaken. After separation, the chloroform layer was run into the original extraction flask and the acid aqueous layer transferred to a beaker. The chloroform was replaced into the separating funnel and a second 20cm³ 1M HCl added. The contents were shaken and after separation, the chloroform layer was run off and discarded. The first 20cm³ of acid solution was added to that remaining in the separating funnel and neutralised with 40cm³ 1M NaOH solution. The pH was measured using indicator paper and if still acid, a further 5cm³ of alkali added to ensure an alkaline solution.

0.05g of 1-chloro-2,4-dinitrobenzene was weighed into a beaker, 5 cm³ diethyl ether added and swirled to dissolve. (N.B. The reagent was not allowed to contact the skin as it is an allergen). The reagent solution was added to the separating funnel and the contents were shaken for at least one minute. 10cm³ of methylene chloride were added and the contents shaken again for at least one minute. After separation the lower layer was run into a porcelain dish. The contents of the separating funnel were extracted with two further 10cm³ portions of methylene chloride, which were added to the porcelain dish.

The methylene chloride was allowed to evaporate almost to dryness , then quantitatively transferred to a 2cm³ volumetric flask using methylene chloride. 10ul of this solution were analysed by liquid chromatography.

4.6.1. Results

To calculate the % accelerator from the derivative peak area , the following equation was used:-

$$\% \text{ accelerator} = \frac{A \times C \times 100}{B \times D \times W}$$

where : A = Area of sample peak

B = Area/mg of standard amine derivative

C = Molecular weight of accelerator

D = Molecular weight of amine from accelerator

W = Weight of sample in milligrams

For CBS B = 4148330 x 10⁻¹ mv/sec
 C = 264
 D = 98

For MBS B = 3675860 x 10⁻¹ mv/sec
 C = 252
 D = 87

For DCBS B = 4841950 x 10⁻¹ mv/sec
 C = 346
 D = 179

The results for the duplicate analyses of the AN5004 rubber compounds are shown in Table 19.

TABLE 19

RESULTS FOR ANALYSIS OF AN5004 RUBBER COMPOUNDS

Sample	Weight of Cpd. mg	Area of Deriv. Peak	% Accel Found	% Recovery
AN5004	2041.15	18448350	0.59	92.2
/A	1946.19	18581142	0.62	96.9
AN5004	1999.32	16099600	0.63	98.4
/B	1983.53	14602990	0.61	95.3
AN5004	2163.46	30890255	0.57	89.1
/C	1972.89	27263650	0.55	85.9

4.7. Determination of MBT

In order to complete the determination of accelerators, it was felt that some attempt should be made to analyse for the presence of MBT, which is also generated from the breakdown of the sulphenamide accelerators. The MBT is generally accepted to link onto the polymer chain as a pendant group, and as such is not extractable with solvents.

About 0.1g of AN5004/A was cut into small pieces and placed in the bottom of a glass tube and about 0.1g of powdered solid sodium hydroxide added. The open end of the tube was then sealed and the end of the tube containing the sample was placed into a small tube furnace. The tube was heated at 200°C for 10 minutes, then the temperature increased to 450°C for a further 10 minutes. The tube was then cooled, broken open and placed into 20cm³ of distilled water in a beaker. The water was boiled, cooled and transferred to a separating funnel. 20cm³ of

chloroform was added and the contents shaken. After separation, the chloroform layer was run off and discarded. The aqueous phase was acidified with hydrochloric acid to convert the water soluble sodium MBT to MBT, then extracted with 10cm³ fresh chloroform. The chloroform was evaporated to about 1cm³ and 10ul injected into the HPLC using the reverse phase column and the solvent programme given in section 3.6. except that water was used instead of sodium acetate solution. The chromatograph showed a major peak at 3.57 minutes, which compares favourably with the peak from std MBT similarly treated of 3.45 minutes. An ultraviolet spectrum of the eluted peak from the HPLC column showed it to be identical to std MBT. The chromatograms are shown as Figures 50 and 51.

FIGURE 50

CHROMATOGRAM OF MBT FROM AN5004/A

CHART SPEED 0.5 CM/MIN
ATTEN: 16 ZERO: 5% 5 MIN/TICK

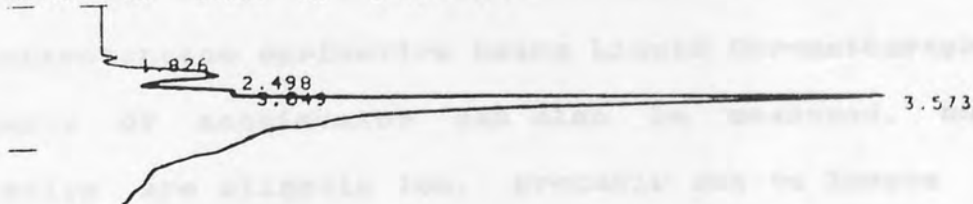

RECALC
TITLE: DETERMINATION OF MBT

10:50 1 APR 85

⑤ CHANNEL NO: 1 SAMPLE: AN5004/C

METHOD: HPLC1

PEAK NO	PEAK NAME	RESULT AX	TIME (MIN)	TIME OFFSET	AREA COUNTS	PRT	SEP CODE
1		10.47410	2.498		47608	0.57	VV
2		3.72671	3.049		16939	0.70	VV
3		85.79920	3.573		389982	0.82	VV
TOTALS:		100.0000			454523		

FIGURE 51

CHROMATOGRAM OF STANDARD MBT

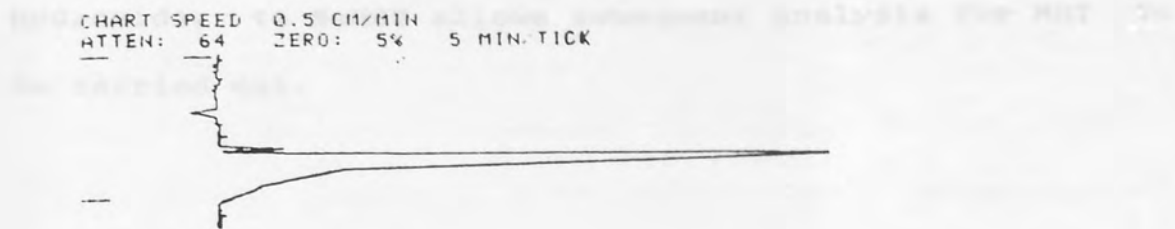

TITLE: DETERMINATION OF MBT . 15:22 29 MAR 85
CHANNEL NO: 1 SAMPLE: MBT STD METHOD: HPLC1

PEAK NO	PEAK NAME	RESULT AX	TIME (MIN)	TIME OFFSET	AREA COUNTS	PPT	SEP CODE
1		100.0000	3.575		1092810	0.01	VR
TOTALS:		100.0000			1092810		

4.7. Discussion and Conclusions

The type of sulphenamide accelerator used in vulcanised rubber compounds can be determined by extraction of the liberated amine and its determination as a 1-chloro-2,4-dinitrobenzene derivative using Liquid Chromatography. The amount of accelerator can also be measured, but the results are slightly low, probably due to losses during the vulcanisation process. It would appear that dicyclohexylamine gives two distinct derivatives and if the peak areas of both were used, the results would be closer to 100% recovery.

Conversion of the MBT attached to the rubber chain, by low temperature heating in the presence of sodium hydroxide, to NaMBT allows subsequent analysis for MBT to be carried out.

The use of high accelerator to sulphur ratios leads to the efficient formation of thermally stable monosulphidic cross-links during vulcanisation. The use of sulphur donor materials, such as tetrabutyl thiuram disulphide (TBD), which need not have added sulphur, gives efficient vulcanisation as the sulphur is liberated in situ as mono- or disulphides.



TBD

The use of efficient vulcanisation systems in tyre technology leads, however, to deficiencies in some physical properties such as flaking and tear strength. The high accelerator loadings required also lead to bleed problems, lack of tack and high cost. Hence the so-called semi-efficient vulcanising system tends to be used with intermediate accelerator to sulphur ratios, which give good initial physical properties and good ageing properties also.

Previous workers have studied the chemical reactions taking place during the vulcanisation of compounds based on natural rubber. The experimental work carried out in this chapter is a study of the reactions taking place in a

CHAPTER 5

THE FATE OF ACCELERATOR AND SULPHUR DURING VULCANISATION

5.1. Introduction

The use of high accelerator to sulphur ratios leads to the efficient formation of thermally stable monosulphidic cross-links during vulcanisation. The use of sulphur donor materials, such as tetramethyl thiuram disulphide (TMTD), when used without added sulphur, gives efficient vulcanisation as the sulphur is liberated only as mono- or disulphides.

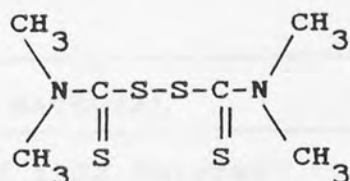

TMTD

The use of efficient vulcanisation systems in tyre technology leads, however, to deficiencies in some physical properties such as flexing and tear strength. The high accelerator loadings required also lead to bloom problems, lack of tack and high cost. Hence the so-called semi-efficient vulcanising system tends to be used with intermediate accelerator to sulphur ratios, which give good initial physical properties and good ageing properties also.

Previous workers have studied the chemical reactions taking place during the vulcanisation of compounds based on natural rubber. The experimental work carried out in this chapter is a study of the reactions taking place in a

compound based on a styrene-butadiene polymer system.

5.2. Rubber Compound Formulations

A typical, but simple, SBR rubber compound formulation was devised which contained the polymer, carbon black and curing system, but without the complication of oil, antidegradants, resins, waxes and retarders. It was designated AO5514 and the formulation is shown in Table 20.

TABLE 20

FORMULATION OF AO5514 COMPOUND

MATERIAL	PARTS BY WEIGHT
SBR 1502 Polymer	100.0
N375 Carbon Black	40.0
Zinc Oxide	1.5
Stearic Acid	1.0
Sulphur	1.9
MBS Accelerator	1.1
Total	145.5

This formulation was laboratory mixed and sheeted out on a mill to a thickness of 6mm. The accelerator and sulphur percentages are 0.76 and 1.31 respectively.

After the initial work, the formulation was modified to include variations on the ratios of sulphur to accelerator. The initial formulation was remixed and four variations were produced; two (D,E) in which the accelerator was kept constant but the sulphur was altered by +/- 25% and in the other compounds (B,C) the sulphur

content was kept constant and the accelerator was changed by +/- 25%. This set of compounds was designated AN5910/A-E and the formulations are shown in Table 21.

TABLE 21
FORMULATIONS OF AN5910/A-E RUBBER COMPOUNDS

MATERIAL	PARTS BY WEIGHT				
	A	B	C	D	E
SBR 1502 Polymer	100.00	100.00	100.00	100.00	100.00
N375 Carbon Black	40.00	40.00	40.00	40.00	40.00
Zinc Oxide	1.50	1.50	1.50	1.50	1.50
Stearic Acid	1.00	1.00	1.00	1.00	1.00
Sulphur	1.90	1.43	2.38	1.90	1.90
MBS Accelerator	1.10	1.10	1.10	0.83	1.38
TOTALS	145.50	145.03	145.98	145.23	145.78

The levels of accelerator and sulphur as percentages are shown in Table 22.

TABLE 22
PERCENTAGE ACCELERATOR AND SULPHUR IN AN5910/A-E

	AN5910 COMPOUND				
	A	B	C	D	E
MBS	0.76	0.76	0.76	0.57	0.91
Sulphur	1.31	0.99	1.63	1.31	1.30

The weight ratios of accelerator to sulphur are as follows:-

- A = 1:1.72
- B = 1:1.30
- C = 1:2.14
- D = 1:2.30
- E = 1:1.43

5.3. Rheometry

Each compound was examined using a Monsanto Rheometer at a temperature of 150°C. The rheometer curves are shown as Figure 52. (AN5910/A is the same as A05514) The calculated results from the curves are shown in Table 23.

FIGURE 52
TIME/TORQUE CURVES FOR AN5910/A-E

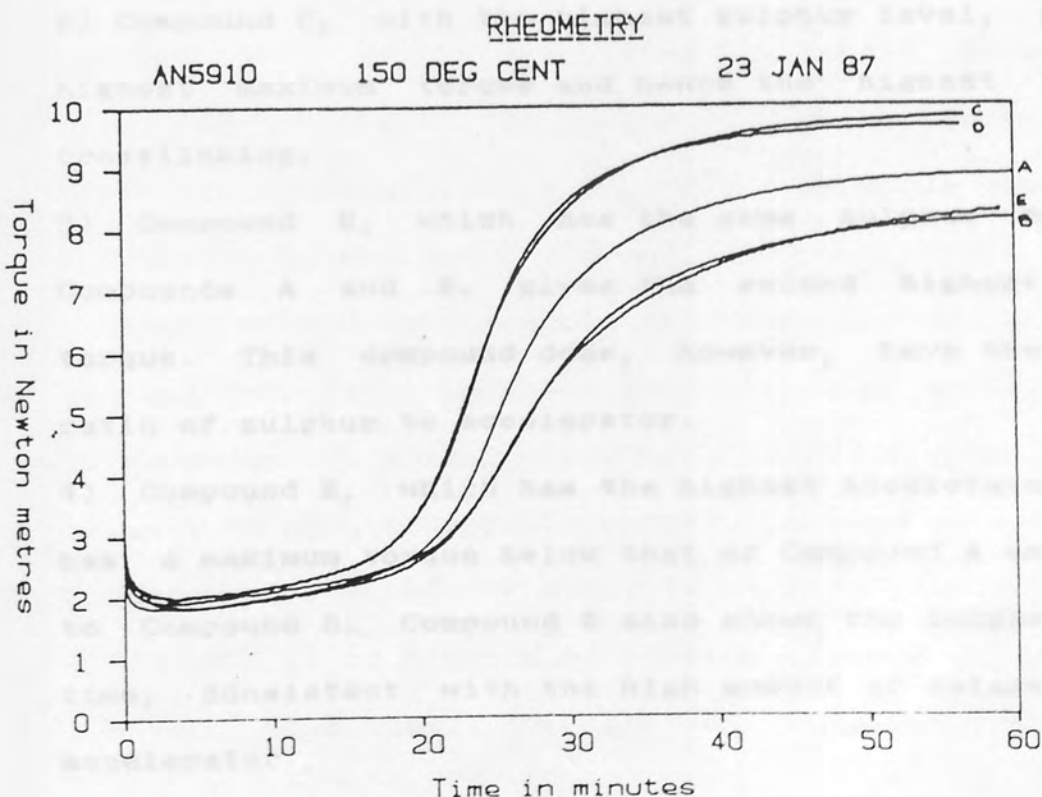

TABLE 23

CALCULATED RHEOMETER RESULTS FOR AN5910/A-E

PROPERTY	A	B	C	D	E
Minimum torque N.m	1.81	1.90	1.97	1.97	1.81
Scorch Time min.	10.17	10.58	10.67	10.83	12.42
T35 min.	24.08	25.25	22.42	22.50	25.17
T90 min.	37.50	40.92	34.25	32.75	43.33
Optimum torque N.m	8.89	8.13	9.78	9.66	8.26
Accelerator %	0.76	0.76	0.76	0.57	0.91
Sulphur %	1.31	0.99	1.63	1.31	1.30

The rheometer results show, in comparison to the standard compound A, that:-

- 1) Compound B, with the lowest sulphur level, gives the lowest maximum torque and hence the lowest level of crosslinking.
- 2) Compound C, with the highest sulphur level, gives the highest maximum torque and hence the highest level of crosslinking.
- 3) Compound D, which has the same sulphur content as Compounds A and E, gives the second highest maximum torque. This compound does, however, have the highest ratio of sulphur to accelerator.
- 4) Compound E, which has the highest accelerator level, has a maximum torque below that of Compound A and similar to Compound B. Compound E also shows the longest scorch time, consistent with the high amount of delayed action accelerator.

So, as far as chemical crosslinking is concerned, it is not only dependant on the level of sulphur but also the ratio of sulphur to accelerator in the rubber compound.

5.3.1. Preparation of Samples for Analysis

Samples were cut from each compound mill sheet, as circular discs, and placed into the rheometer at a temperature of 150°C. After predetermined intervals, the sample was removed and immediately immersed in cold water to stop any further chemical reactions. The initial work on Compound AO 5514 was carried out by allowing the torque to reach a given value, e.g. 0.18Nm (2"1b) on the chart, then removing the sample. Because of this, the times of reaction in the rheometer are of peculiar intervals. Subsequent work on AN 5910 compounds was carried out by leaving the sample in the rheometer chamber for set periods of time - disregarding the actual torque value given on the chart. As graphs were to be plotted of the amounts of sulphur, accelerator etc, against time, then the latter method was preferred.

When cool, each sample was taken out of the water, blotted dry and the whole rheometer disc milled into a thin sheet on a laboratory cold mill. Samples of about 0.5 - 0.7g were accurately weighed to the nearest 0.01mg. These samples were then cut into small pieces and immersed in 15cm³ of a mixture of dichloromethane / 2-propanol 1:2 v/v in a vial. The vial was capped and allowed to

stand in the dark, at room temperature for 24 hours with occasional shaking. The solvent was then transferred quantitatively to a low actinic glass 25cm³ volumetric flask, 1cm³ 2-butanone (methyl ethyl ketone) added as internal standard and the contents made up to the mark with 2-propanol.

5.4. Analysis by Liquid Chromatography

10 µl of each solution were injected, in turn, onto the reverse phase column of the HPLC and analysed using the conditions as shown in Table 24 and the solvent programme shown in Table 25. The results were processed by the Vista 401 data system.

TABLE 24

HPLC INSTRUMENT CONDITIONS

Solvent Flow Rate	1cm ³
Column	30cm x 4mm i.d. 10 micrometer Silica, coated with octadecylsilane
Column Temperature	30°C
Chart Speed	0.5 or 0.2 cm/min
Detector	254nm wavelength
Attenuation	0.08 A.U. full scale

TABLE 25

SOLVENT PROGRAMME

TIME (min)	% WATER	% ACETONITRILE
0	70	30
2	70	30
17	50	50
20	50	50
27	30	70
40	30	70
45	0	100
50	0	100
55	70	30

5.4.1. Results for AO 5514 Compound

The weights of sulphur and accelerator in the 25cm³ of solution were calculated by the data system, using the internal standard calculation. These weights were then converted into percentages using the original weight of rubber sample. The results for the first set of analyses are given in Table 26 and the chromatograms are shown as Figures 53 to 62.

The internal standard calculation used 0.8049g as the weight of 2-butanone together with 0.005095 and 0.00798 as the relative response values for MBS and sulphur respectively.

TABLE 26

FATE OF SULPHUR , ACCELERATOR AND REACTION PRODUCT
IN AO 5514 COMPOUND

TIME AT 150°C (min)	SULPHUR %	MBS %	REACTION PRODUCT	
			Area/mg Spl	RRT (min)
0	0.88	0.55	665	0.48
3.60	0.79	0.37	864	0.52
6.72	0.70	0.28	1256	0.55
10.20	0.67	0.19	1749	0.60
14.10	0.67	0.10	1813	0.69
25.50	0.31	0	2420	0.80
27.60	0.30	0	2221	0.84
39.70	0.06	0	1460	0.89
67.80	0.02	0	758	0.93
70.92	0	0	662*	1.00

RRT = Relative Retention Time compared to 2-butanone.

The integrated areas are measured by the integrator in the form 1 count = 0.1mv/sec. The peak for the reaction product in the last sample had the same retention time as the internal standard peak. The result of 662 for the peak area (marked with an *), was calculated by subtracting the average peak area for the internal standard from the area of the peak containing both materials. These results are shown in graphical form in Figure 53 and the chromatograms are shown as Figures 54 to 63.

FIGURE 53

RESULTS FOR AMOUNTS OF SULPHUR, ACCELERATOR AND REACTION

PRODUCT , FOUND IN AO 5514 SHOWN IN GRAPHICAL FORM

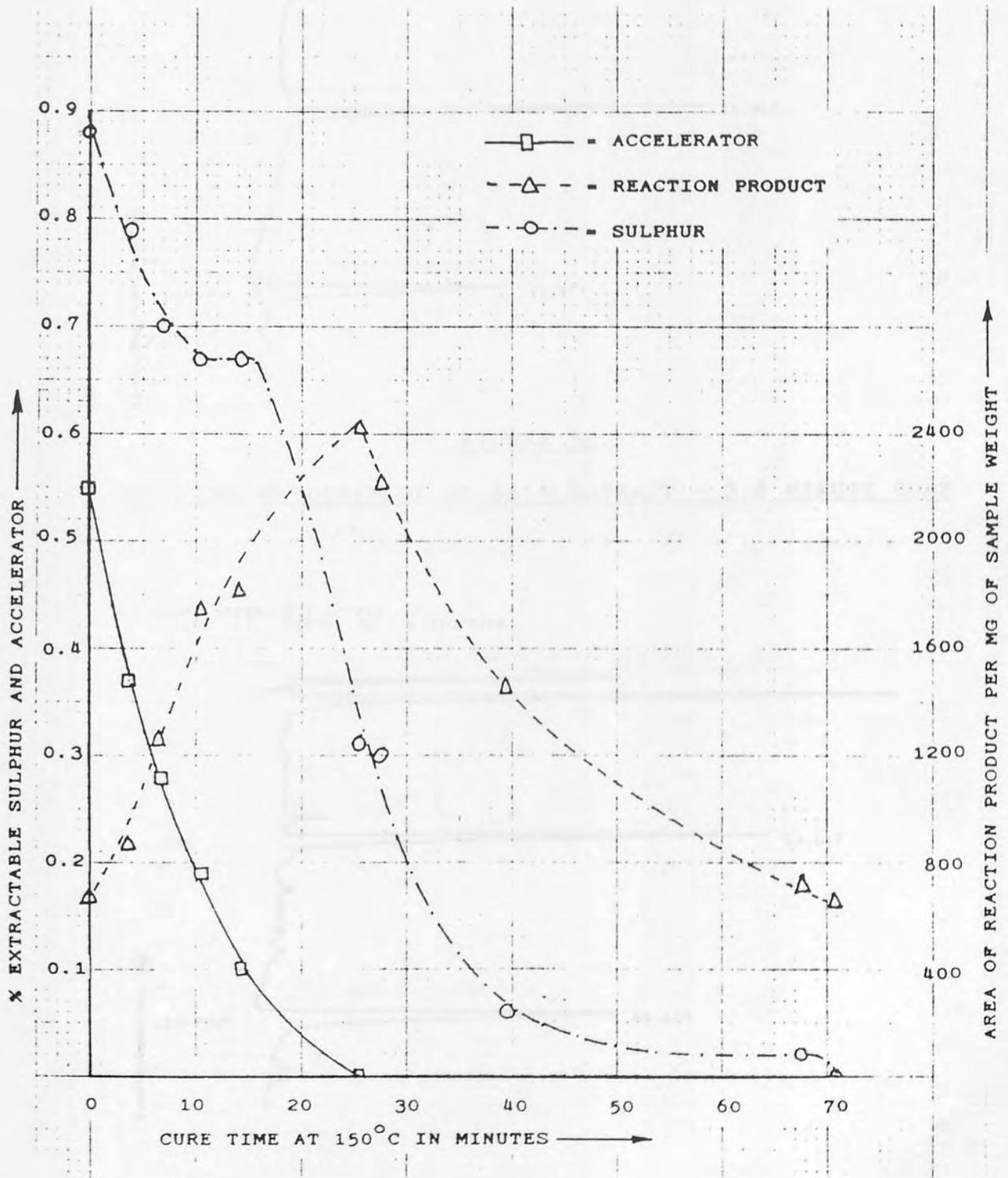

FIGURE 54

HPLC CHROMATOGRAM OF AO 5514 EXTRACT -- UNCURED COMPOUND

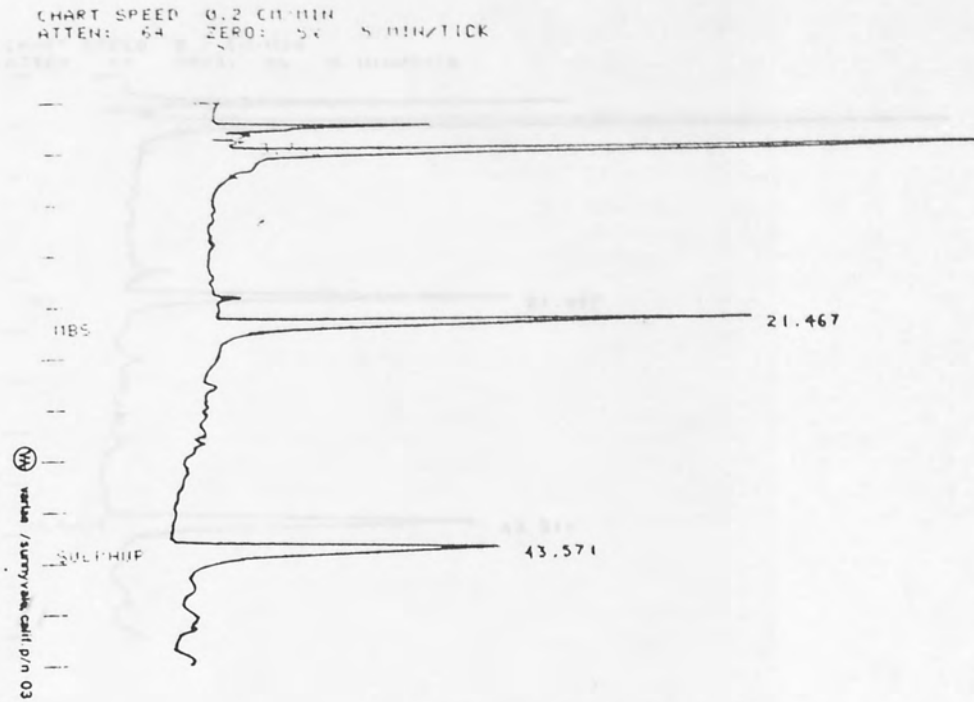

FIGURE 55

HPLC CHROMATOGRAM OF AO 5514 EXTRACT - 3.6 MINUTE CURE

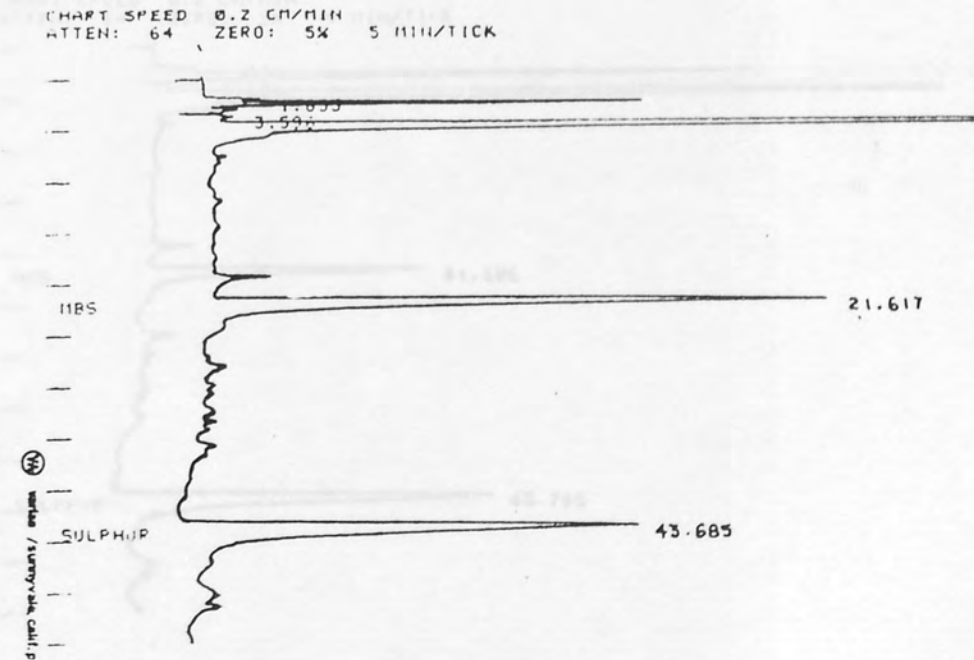

FIGURE 56

HPLC CHROMATOGRAM OF AO 5514 EXTRACT - 6.72 MINUTE CURE

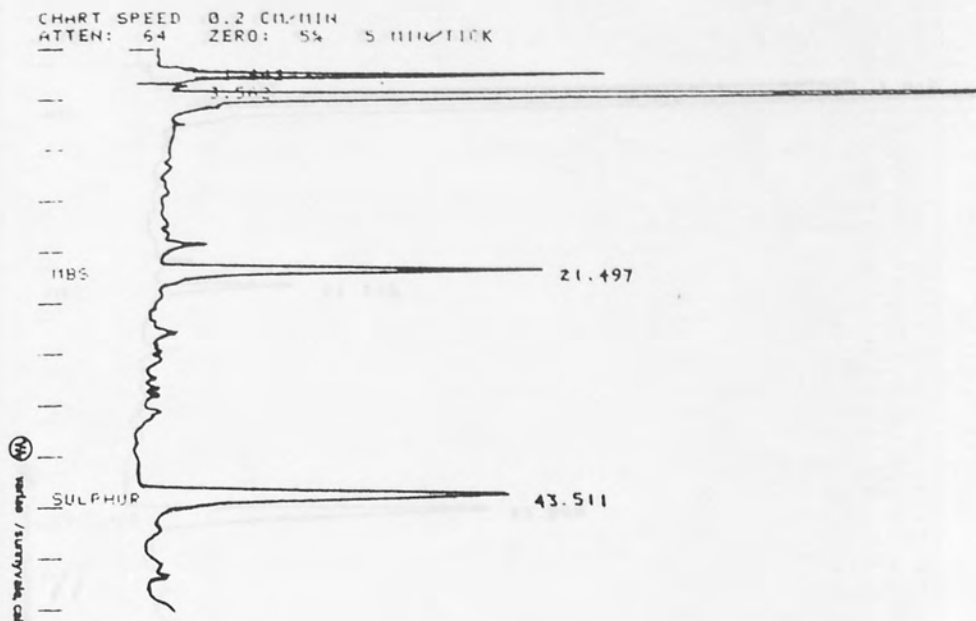

FIGURE 57

HPLC CHROMATOGRAM OF AO 5514 EXTRACT - 10.2 MINUTE CURE

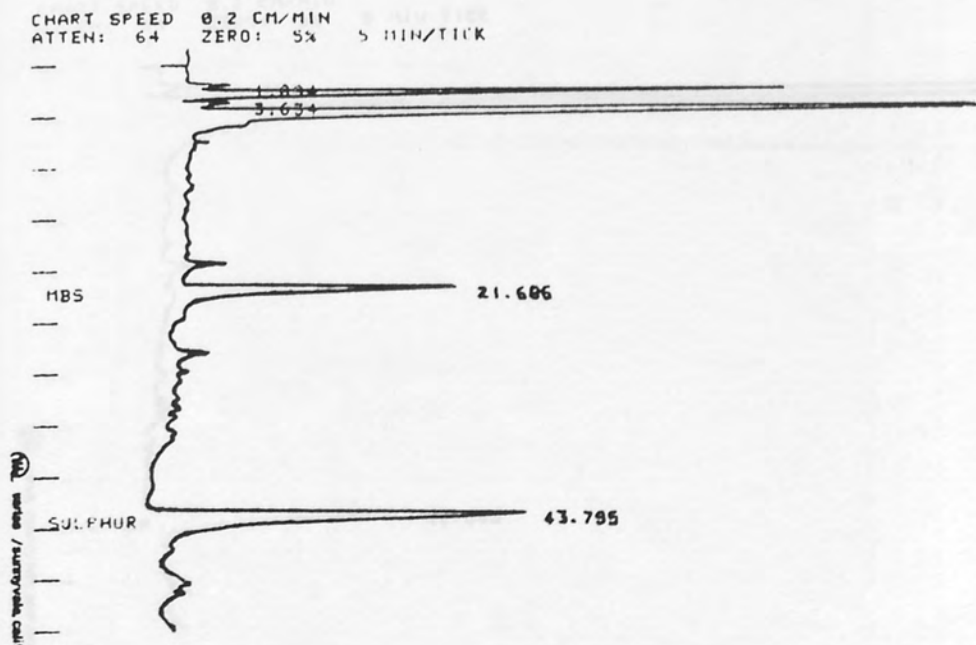

FIGURE 58

HPLC CHROMATOGRAM OF AO 5514 EXTRACT - 14.1 MINUTE CURE

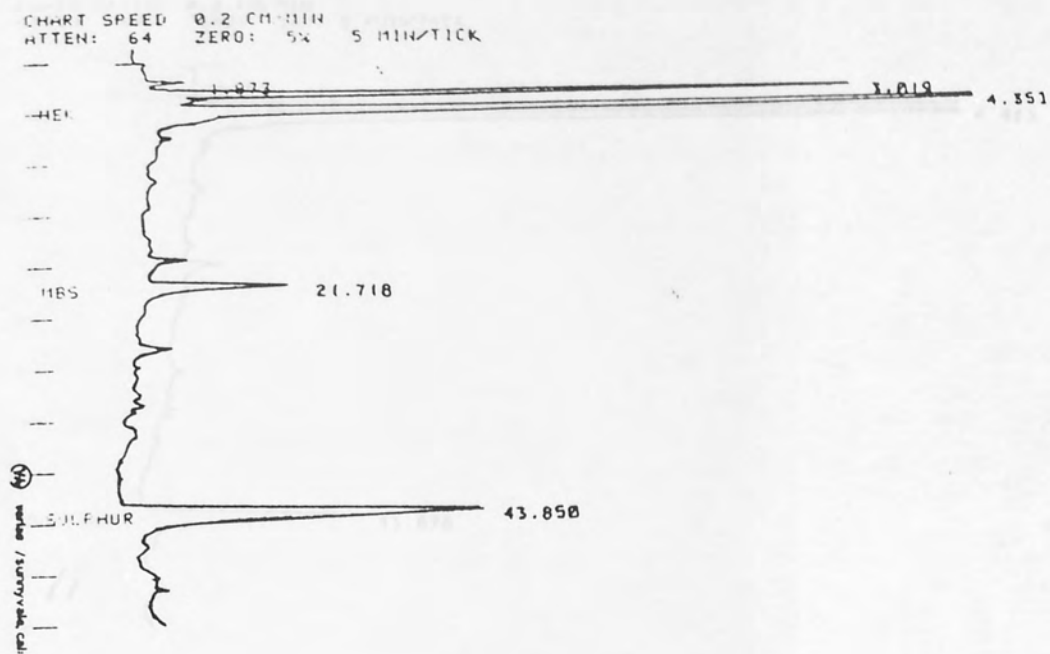

FIGURE 59

HPLC CHROMATOGRAM OF AO 5514 EXTRACT - 25.5 MINUTE CURE

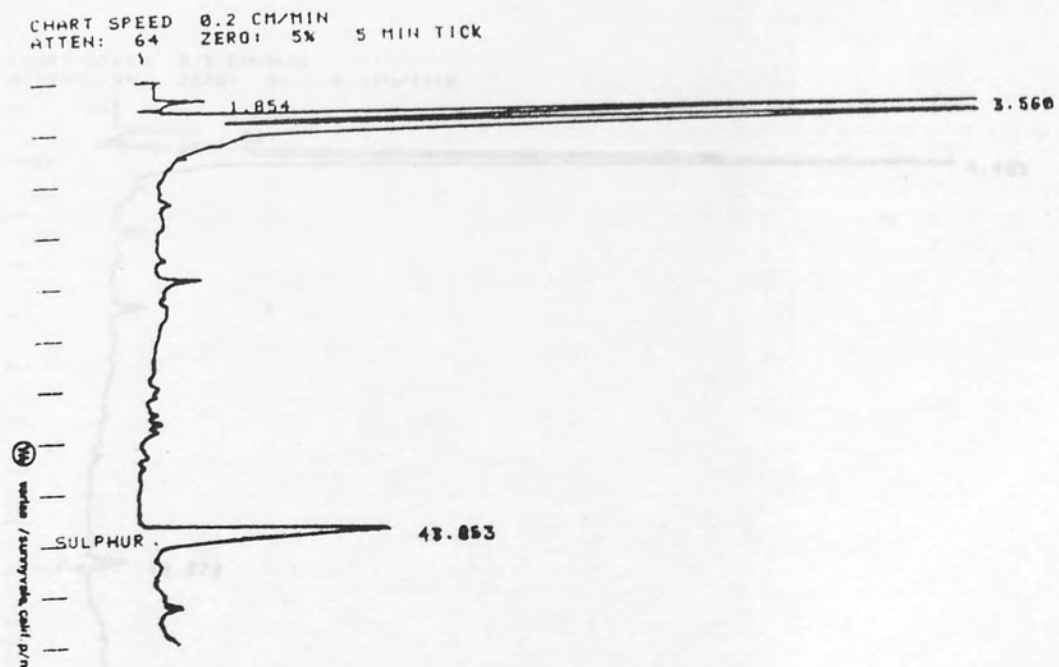

FIGURE 60

HPLC CHROMATOGRAM OF AO 5514 EXTRACT - 27.6 MINUTE CURE

CHART SPEED 0.2 CM/MIN
ATTEN: 64 ZERO: 5% 5 MIN/TICK

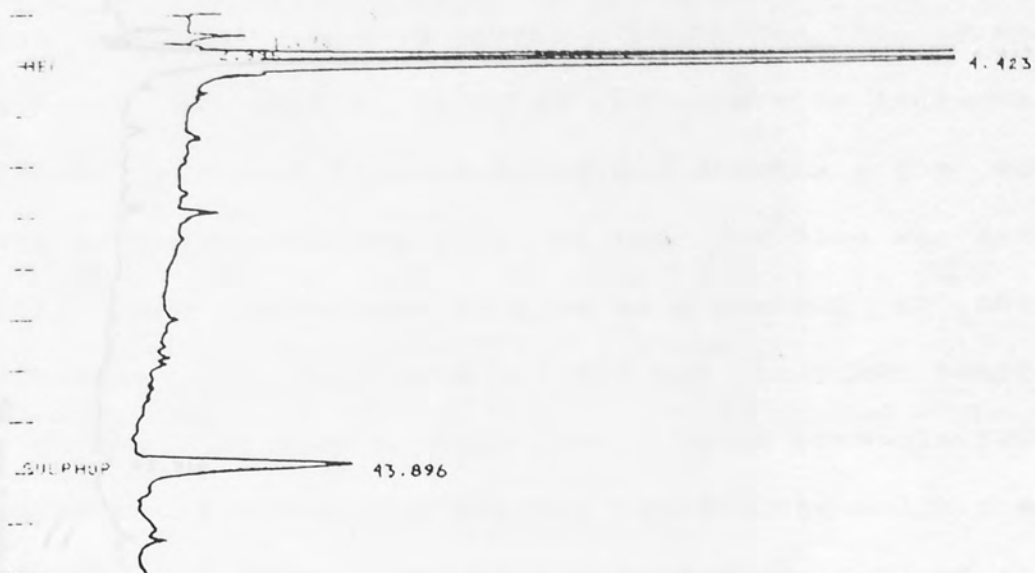

FIGURE 61

HPLC CHROMATOGRAM OF AO 5514 EXTRACT - 39.7 MINUTE CURE

CHART SPEED 0.2 CM/MIN
ATTEN: 64 ZERO: 5% 5 MIN/TICK



FIGURE 62

HPLC CHROMATOGRAM OF AO 5514 EXTRACT - 67.8 MINUTE CURE

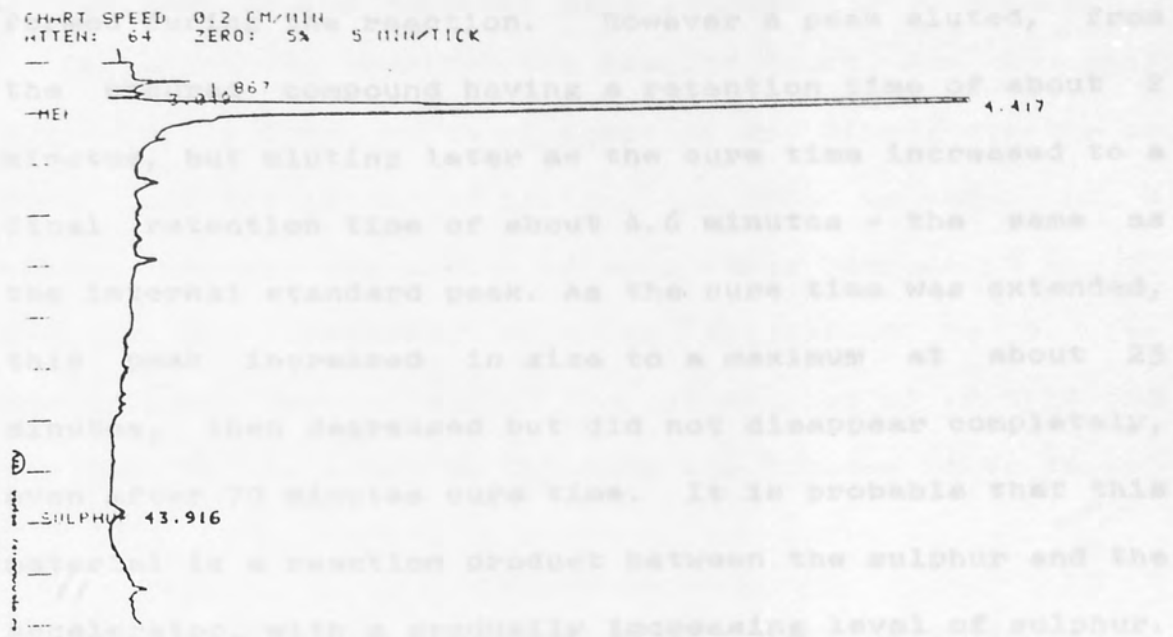
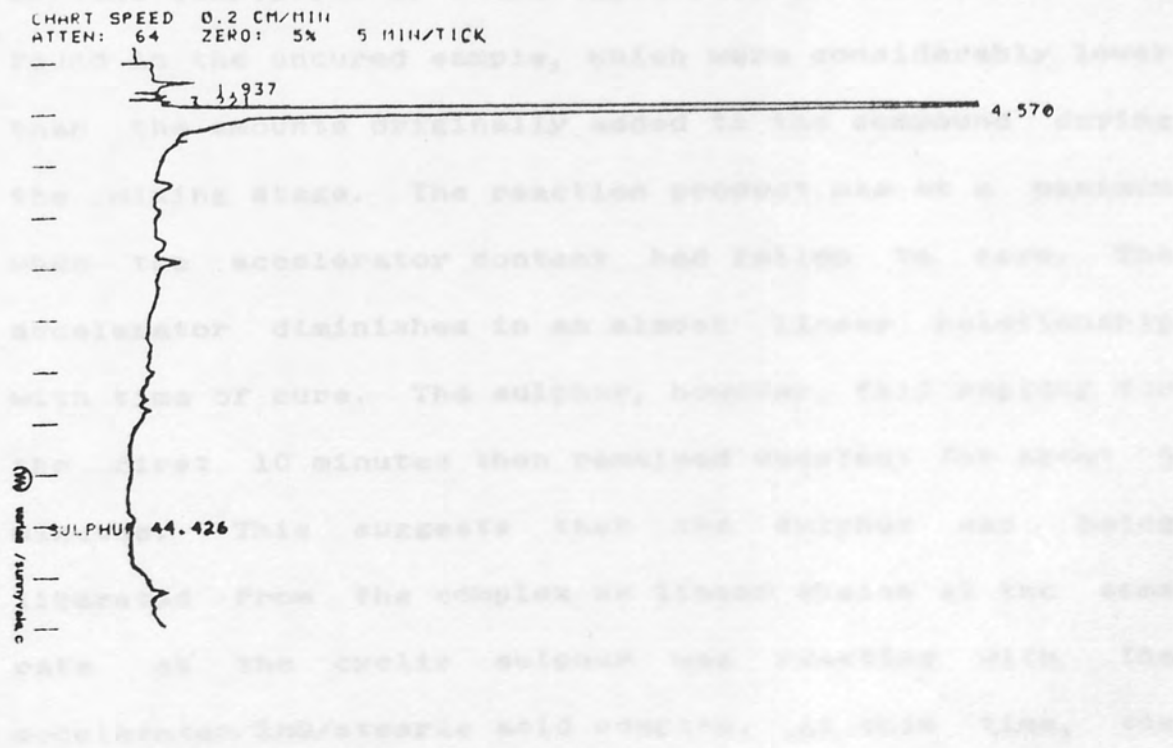

FIGURE 63

HPLC CHROMATOGRAM OF AO5514 EXTRACT - 70.92 MINUTE CURE



5.4.2. Discussion of Initial Results

The analysis showed no evidence of MBT or MBTS being formed during the reaction. However a peak eluted, from the uncured compound having a retention time of about 2 minutes, but eluting later as the cure time increased to a final retention time of about 4.6 minutes - the same as the internal standard peak. As the cure time was extended, this peak increased in size to a maximum at about 25 minutes, then decreased but did not disappear completely, even after 70 minutes cure time. It is probable that this material is a reaction product between the sulphur and the accelerator, with a gradually increasing level of sulphur. The material was present in the unvulcanised compound, which shows that even under mixing conditions, the curative system begins to react. This was also confirmed by the quantities of extractable sulphur and accelerator found in the uncured sample, which were considerably lower than the amounts originally added to the compound during the mixing stage. The reaction product was at a maximum when the accelerator content had fallen to zero. The accelerator diminishes in an almost linear relationship with time of cure. The sulphur, however, fell rapidly for the first 10 minutes then remained constant for about 5 minutes. This suggests that the sulphur was being liberated from the complex as linear chains at the same rate as the cyclic sulphur was reacting with the accelerator/ZnO/stearic acid complex. At this time, the

rate of crosslinking as shown by rheometry, was very slow.

5.4.3. Results for Analysis of AO5514/A.

In order to verify the results found for AO 5514 compound, a fresh batch of compound was mixed, exactly as before and designated AO 5514/A. In order to carry out a closer study, the number of cure times between 10 and 22 minutes was increased from the initial 3 to 9. The analysis was carried out as for the samples of AO 5514 and the results are shown in Table 27 and Figures 64 to 76.

TABLE 27

FATE OF SULPHUR, ACCELERATOR AND REACTION PRODUCT
FROM AO 5514/A

TIME AT 150°C (min)	SULPHUR %	MBS %	REACTION	PRODUCT
			Area/mg Spl	RRT (min)
2.95	0.88	0.42	344	2.02
5.50	0.78	0.33	558	2.08
9.95	0.77	0.18	985	2.09
11.25	0.77	0.14	1226	2.08
11.90	0.76	0.12	1239	2.09
13.50	0.76	0.07	1428	2.09
15.50	0.75	0.03	1534	2.07
19.50	0.70	0.01	2007	2.07
22.50	0.59	0	1870	1.89
25.25	0.49	0	1765	1.97
42.00	0.07	0	1399	2.00
75.00	0.01	0	931	1.96

FIGURE 64

RESULTS FOR SULPHUR, ACCELERATOR AND REACTION PRODUCT

FROM ANALYSIS OF AO 5514/A SHOWN IN GRAPHICAL FORM

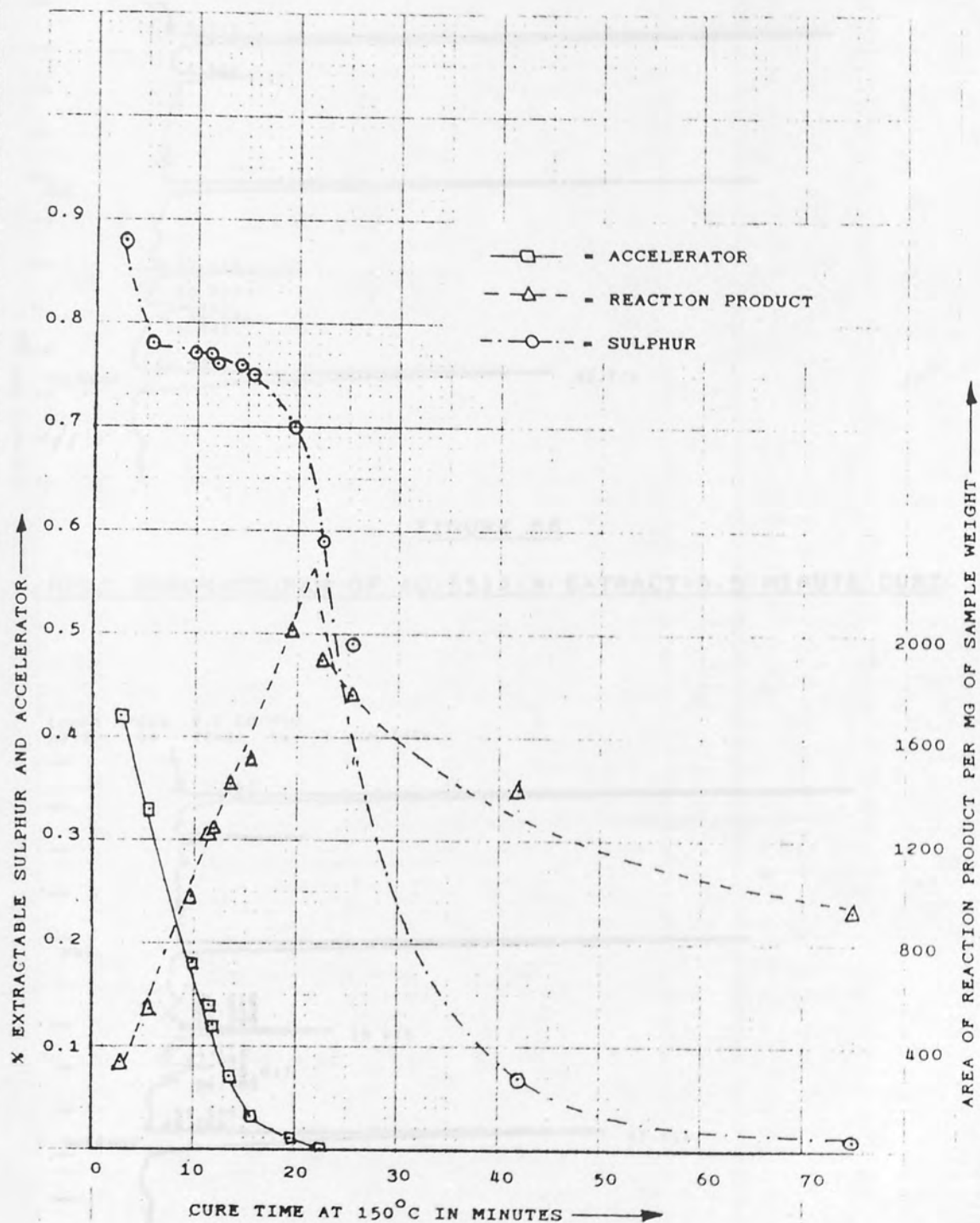

FIGURE 65

HPLC CHROMATOGRAM OF AO 5514/A EXTRACT - 2.95 MINUTE CURE

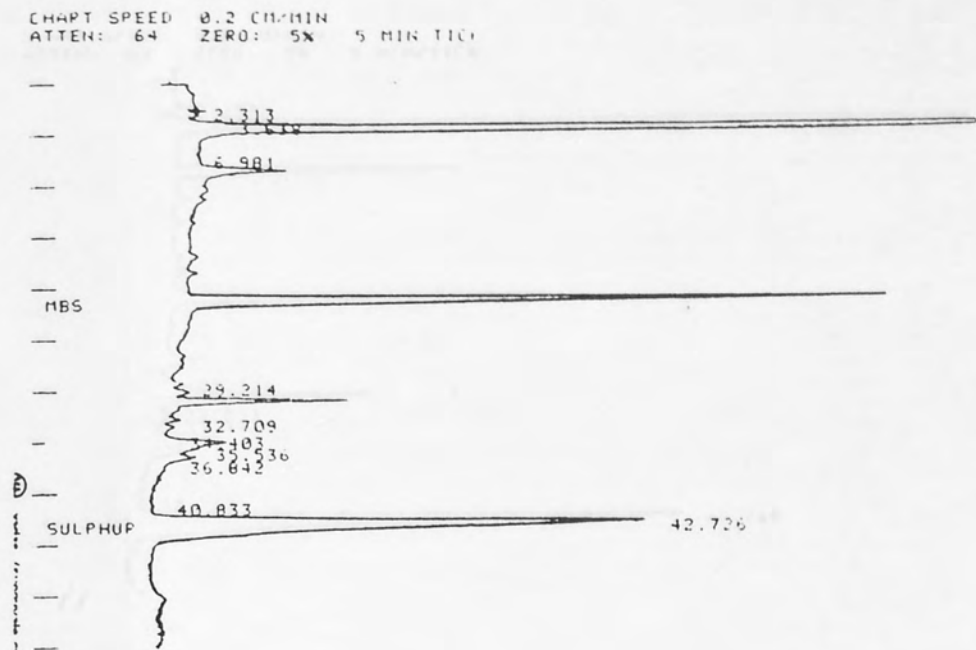

FIGURE 66

HPLC CHROMATOGRAM OF AO 5514/A EXTRACT-5.5 MINUTE CURE

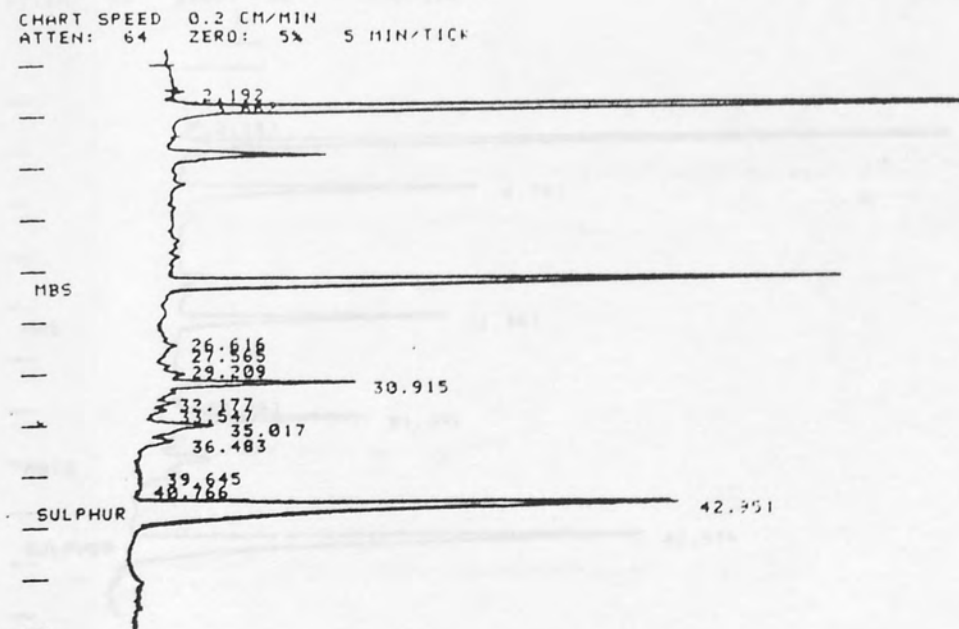

FIGURE 67

HPLC CHROMATOGRAM OF AO 5514/A EXTRACT - 9.95 MINUTE CURE

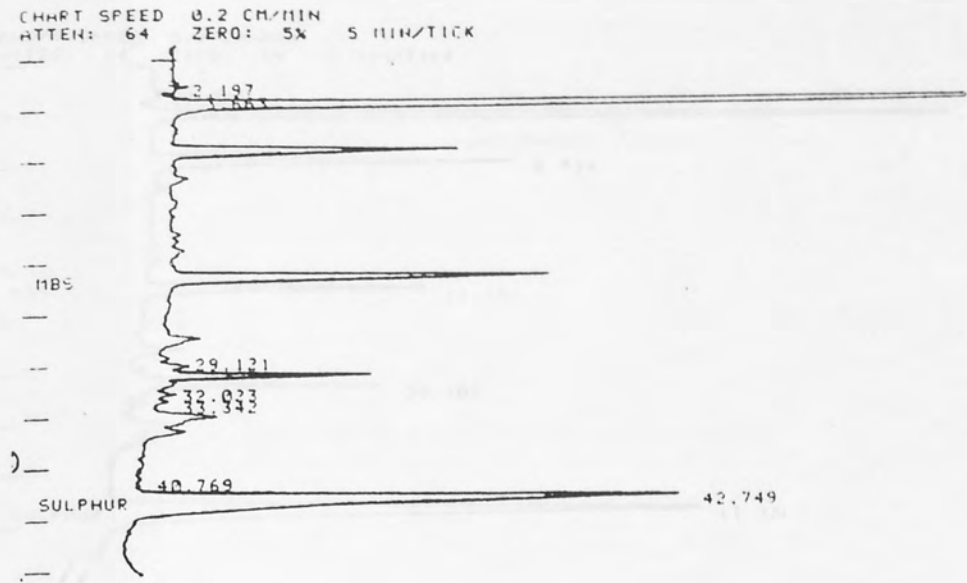

FIGURE 68

HPLC CHROMATOGRAM OF AO 5514/A EXTRACT-11.25 MINUTE CURE

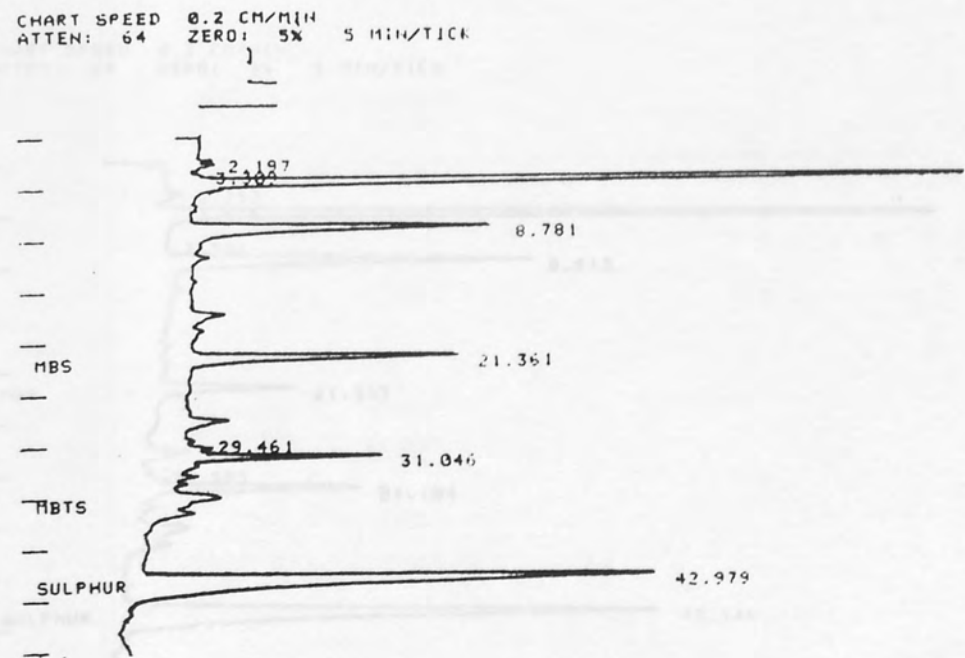

FIGURE 69

HPLC CHROMATOGRAM OF AO 5514/A EXTRACT-11.9 MINUTE CURE

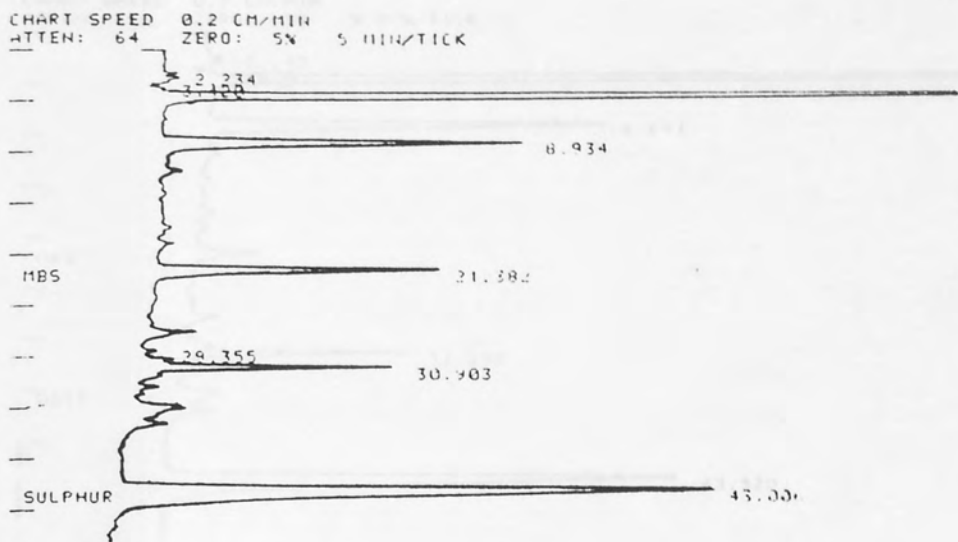

FIGURE 70

HPLC CHROMATOGRAM OF AO 5514/A EXTRACT- 13.5 MINUTE CURE

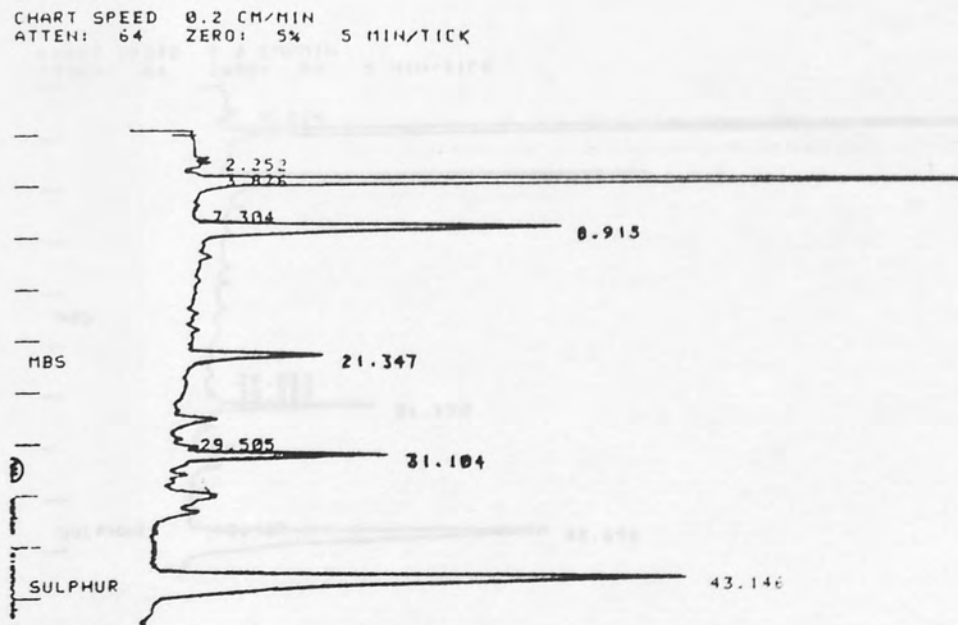

FIGURE 71

HPLC CHROMATOGRAM OF AO 5514/A EXTRACT - 15.5 MINUTE CURE

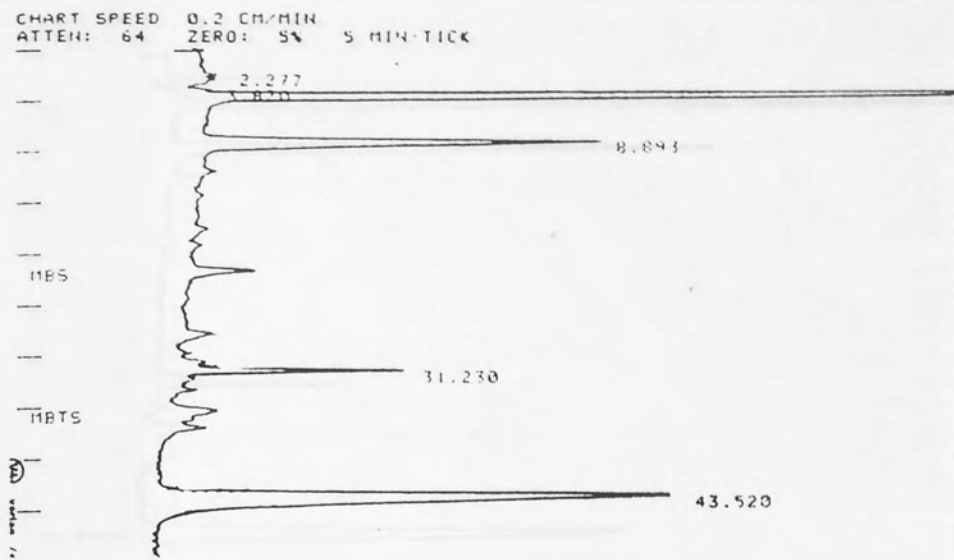

FIGURE 72

HPLC CHROMATOGRAM OF AO 5514/A EXTRACT - 19.5 MINUTE CURE

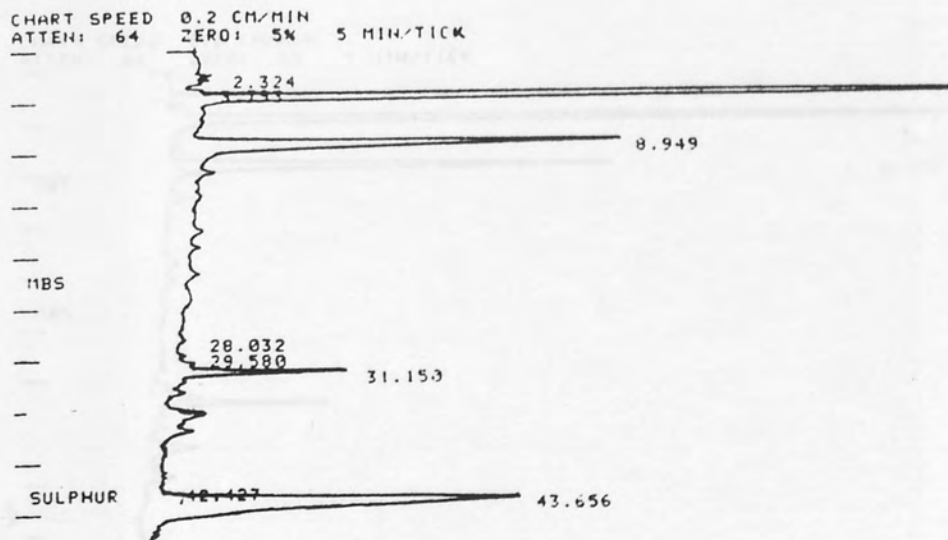

FIGURE 73

HPLC CHROMATOGRAM OF AO 5514/A EXTRACT - 22.5 MINUTE CURE

CHART SPEED 0.2 CM/MIN
ATTEN: 64 ZERO: 5% 5 MIN/TICK

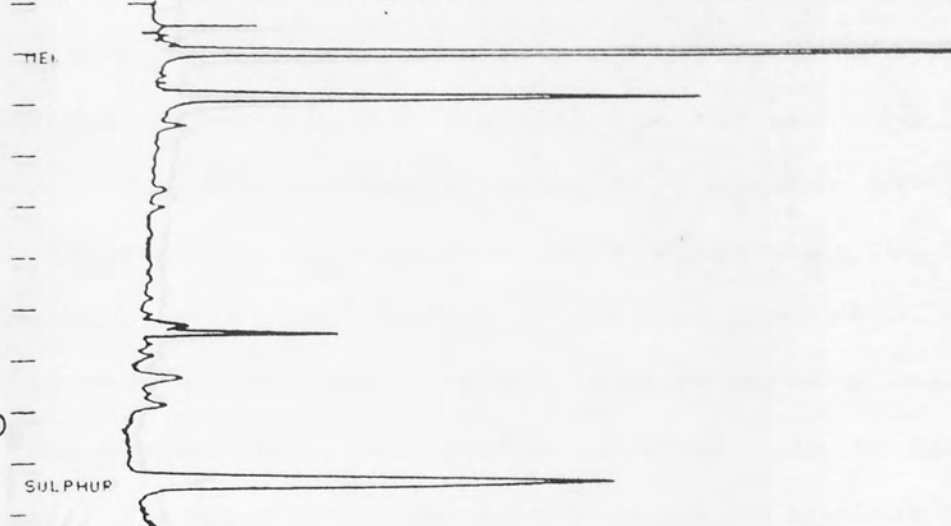

FIGURE 74

HPLC CHROMATOGRAM OF AO 5514/A EXTRACT - 25.25 MINUTE CURE

CHART SPEED 0.2 CM/MIN
ATTEN: 64 ZERO: 5% 5 MIN/TICK

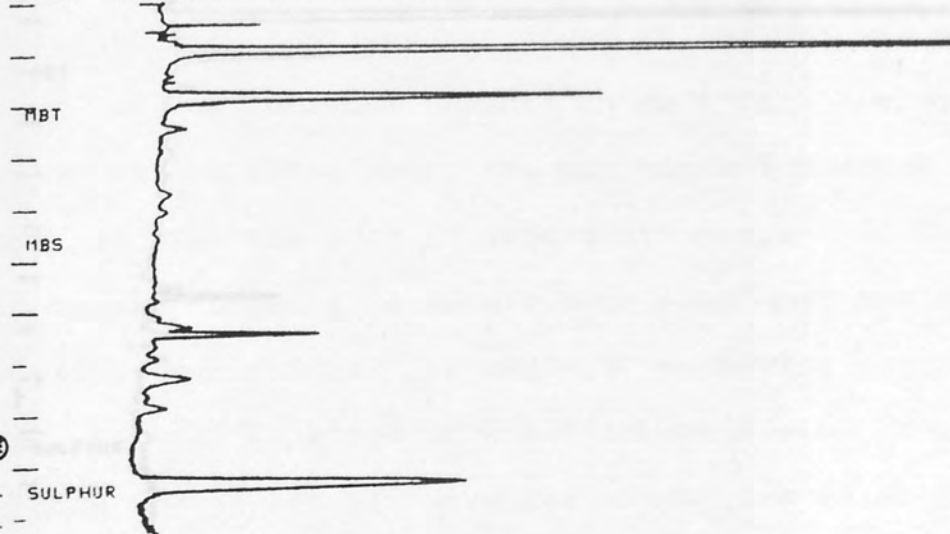

FIGURE 75

HPLC CHROMATOGRAM OF AO 5514/A EXTRACT - 42.0 MINUTE CURE

CHART SPEED 0.2 CM/MIN
ATTEN: 64 ZERO: 5% 5 MIN/TICK

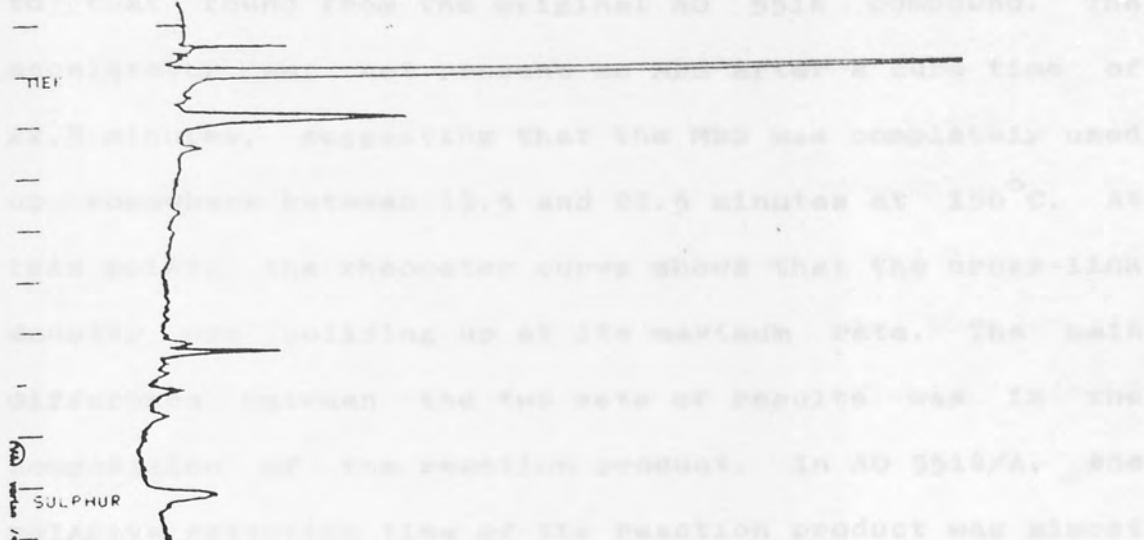
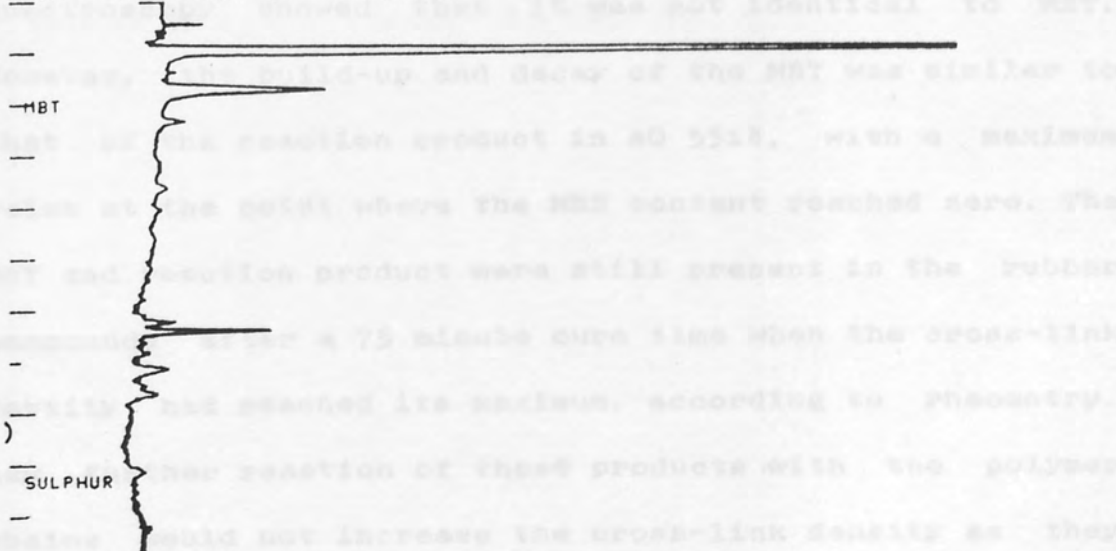

FIGURE 76

HPLC CHROMATOGRAM OF AO 5514/A EXTRACT - 75 MINUTE CURE

CHART SPEED 0.2 CM/MIN
ATTEN: 64 ZERO: 5% 5 MIN/TICK



5.4.4. Discussion of AO 5514/A Results

The decrease in free elemental sulphur was very similar to that found from the original AO 5514 compound. The accelerator was not present as MBS after a cure time of 22.5 minutes, suggesting that the MBS was completely used up somewhere between 19.5 and 22.5 minutes at 150°C. At this point, the rheometer curve shows that the cross-link density was building up at its maximum rate. The main difference between the two sets of results was in the composition of the reaction product. In AO 5514/A, the relative retention time of the reaction product was almost constant at around 2 minutes. Subsequent ultra-violet spectroscopic analysis of the material eluting at this time showed that it gave an identical spectrum to mercaptobenzthiazole (MBT). The reaction product produced in AO 5514 had a changing retention time and ultra-violet spectroscopy showed that it was not identical to MBT. However, the build-up and decay of the MBT was similar to that of the reaction product in AO 5514, with a maximum value at the point where the MBS content reached zero. The MBT and reaction product were still present in the rubber compounds after a 75 minute cure time when the cross-link density had reached its maximum, according to rheometry. Any further reaction of these products with the polymer chains would not increase the cross-link density as they would add on as pendant groups. Why MBT was formed in one compound and not the other is not clear, although it would

probably need only a small change in the kinetics of the reaction for MBT to be liberated from the accelerator - sulphur - zinc oxide - stearic acid complex.

5.5. HPLC Analysis of Compounds AN 5910/A-E

In order to determine the effect of changing the sulphur:accelerator ratio on the overall chemistry of the cure system, compounds AO 5514/A-E were cured for 5, 10, 15, 20, 25, 40, 60 and 70 minutes. The cured samples were solvent extracted and the levels of extractable sulphur, accelerator and any reaction products were determined using HPLC as before.

5.5.1. Results For AN 5910/A-E

The results for extractable sulphur, accelerator and any reaction products are shown in Tables 28 to 32 and graphically in Figures 77 to 81. The chromatograms obtained from the solvent extracts of the 20 minute cure time are shown as Figures 82 to 86.

TIME AT CURE (min)	SULPHUR (%)	MBT (%)	REACTION PRODUCTS	
			ACCELERATOR (%)	MBT (%)
5	0.543	0.783	-	-
10	0.489	0.738	-	-
15	0.430	0.692	-	-
20	0.375	0.646	-	-
25	0.321	0.600	-	-
40	0.270	0.554	-	-
60	0.219	0.508	-	-
70	0.168	0.462	-	-

TABLE 28

FATE OF SULPHUR, ACCELERATOR AND REACTION PRODUCT

IN AN 5910/A COMPOUND

TIME AT 150°C (min)	SULPHUR %	MBS %	REACTION	PRODUCT
			Area/mg Spl	RRT (min)
5	0.813	0.521	522	0.70
10	0.757	0.155	2167	1.00
15	0.749	0.049	2861	1.00
20	0.628	0	3537	1.29
25	0.432	0	2474	1.44
40	0.155	0	1783	1.52
60	0.015	0	1149	1.55
70	0	0	743	1.51

TABLE 29

FATE OF SULPHUR, ACCELERATOR AND REACTION PRODUCT

IN AN 5910/B COMPOUND

TIME AT 150°C (min)	SULPHUR %	MBS %	REACTION	PRODUCT
			Area/mg Spl	RRT (min)
5	0.583	0.225	-	-
10	0.469	0.128	-	-
15	0.450	0.031	-	-
20	0.378	0	-	-
25	0.151	0	-	-
40	0.048	0	-	-
60	0.006	0	-	-
70	0	0	-	-

TABLE 30

FATE OF SULPHUR, ACCELERATOR AND REACTION PRODUCT

IN AN 5910/C COMPOUND

TIME AT 150°C (min)	SULPHUR %	MBS %	REACTION	PRODUCT
			Area/mg Spl	RRT (min)
5	0.667	0.290	419	0.78
10	0.596	0.131	1110	0.86
15	0.583	0.030	1442	0.72
20	0.424	0	1885	0.71
25	0.299	0	1585	0.67
40	0.185	0	1164	0.66
60	0.080	0	877	0.67
70	0	0	245	0.66

TABLE 31

FATE OF SULPHUR, ACCELERATOR AND REACTION PRODUCT

IN AN 5910/D COMPOUND

TIME AT 150°C (min)	SULPHUR %	MBS %	REACTION	PRODUCT
			Area/mg Spl	RRT (min)
5	0.734	0.189	1839	0.68
10	0.590	0	2534	0.52
15	0.312	0	2635	0.55
20	0.166	0	2252	0.53
25	0.094	0	2192	0.51
40	0.016	0	1857	0.47
60	0	0	1832	0.46
70	0	0	1635	0.46

RESULTS FOR AMOUNTS OF SULPHUR, ACCELERATOR AND REACTION PRODUCT, FOUND IN AN 5910/A SHOWN IN GRAPHICAL FORM

TABLE 32

FATE OF SULPHUR, ACCELERATOR AND REACTION PRODUCT
IN AN 5910/E COMPOUND

TIME AT 150°C (min)	SULPHUR %	MBS %	REACTION	PRODUCT
			Area/mg Spl	RRT (min)
5	0.675	0.192	1729	0.57
10	0.590	0.045	2004	0.60
15	0.441	0	1994	0.63
20	0.254	0	1952	0.65
25	0.073	0	1556	0.64
40	0.045	0	1300	0.60
60	0	0	1245	0.62
70	0	0	1205	0.62

FIGURE 77

RESULTS FOR AMOUNTS OF SULPHUR, ACCELERATOR AND REACTION PRODUCT, FOUND IN AN 5910/A SHOWN IN GRAPHICAL FORM

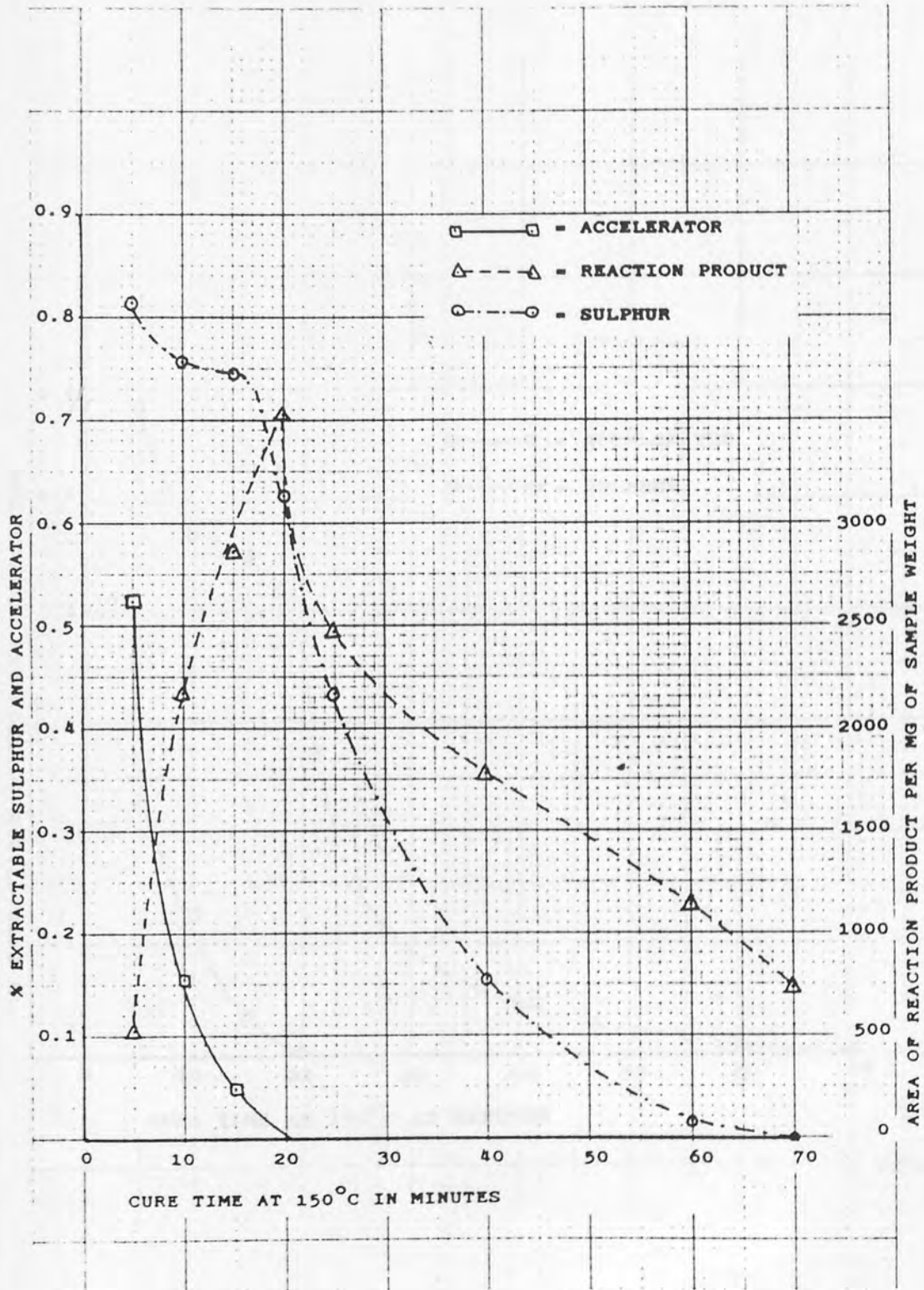

FIGURE 78

RESULTS FOR AMOUNTS OF SULPHUR AND ACCELERATOR
FOUND IN AN5910/B SHOWN IN GRAPHICAL FORM

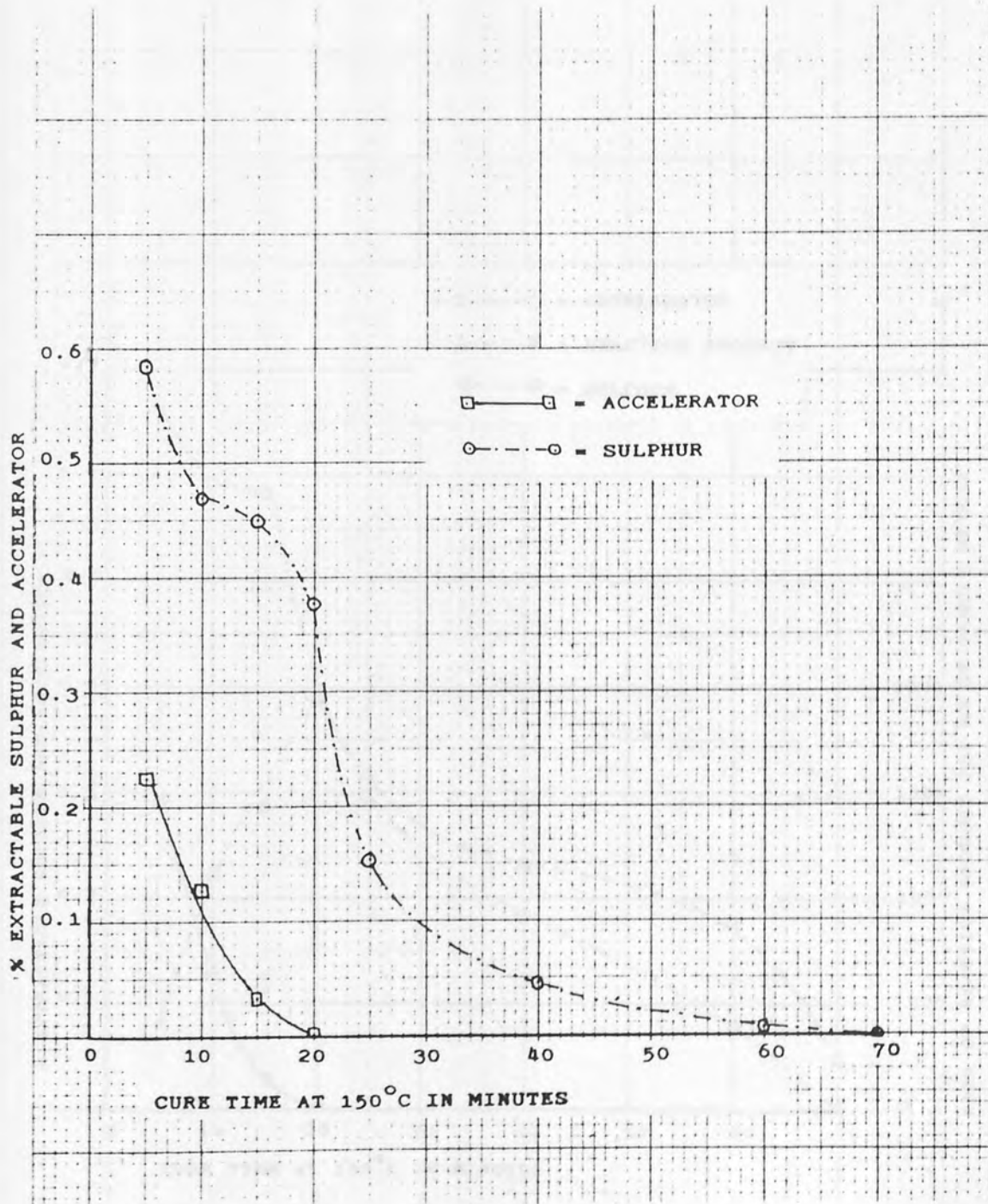

FIGURE 79

RESULTS FOR AMOUNTS OF SULPHUR, ACCELERATOR AND REACTION PRODUCT, FOUND IN AN5910/C. SHOWN IN GRAPHICAL FORM

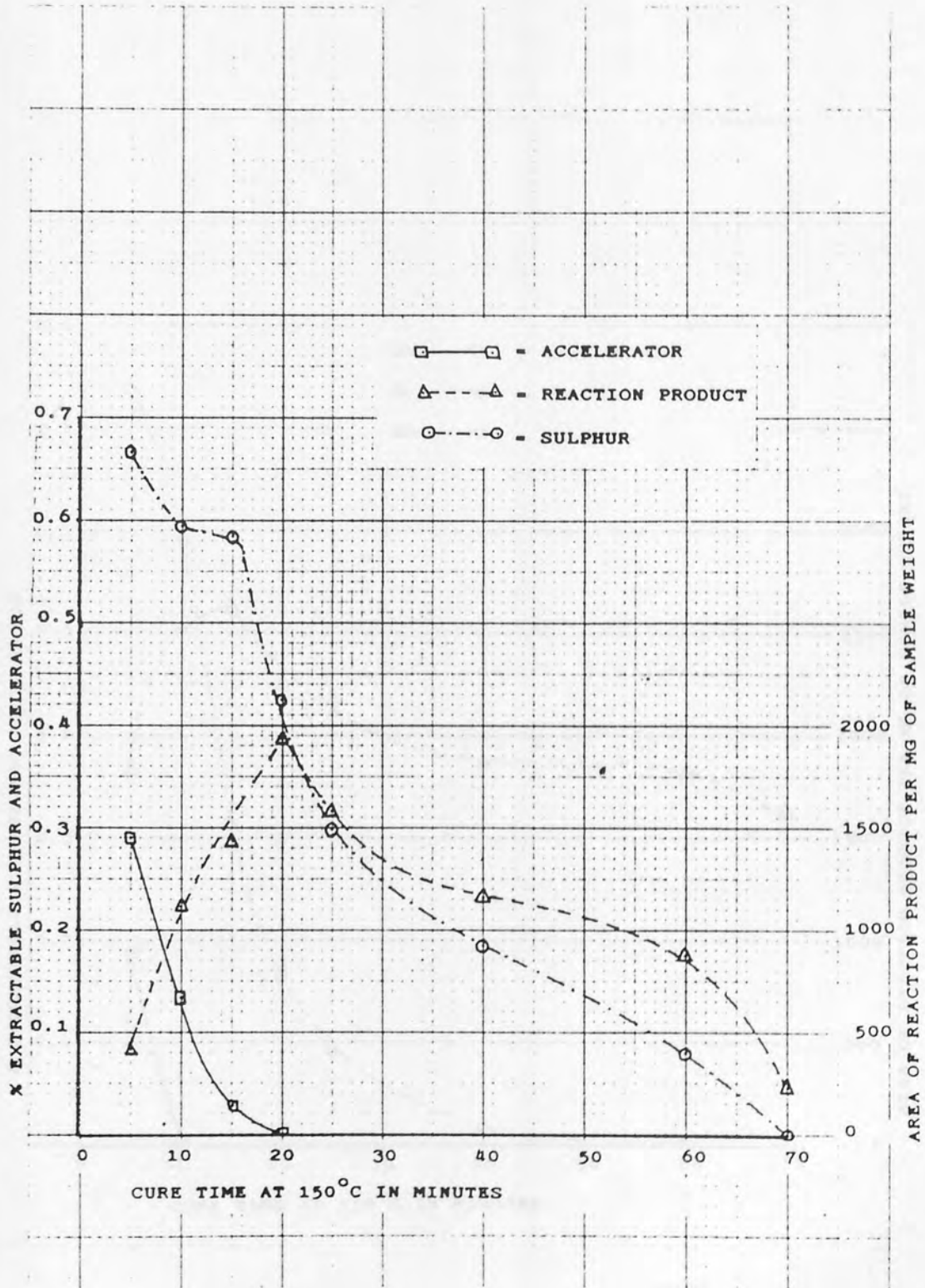

FIGURE 80

RESULTS FOR AMOUNTS OF SULPHUR, ACCELERATOR AND REACTION PRODUCT, FOUND IN AN5910/D. SHOWN IN GRAPHICAL FORM

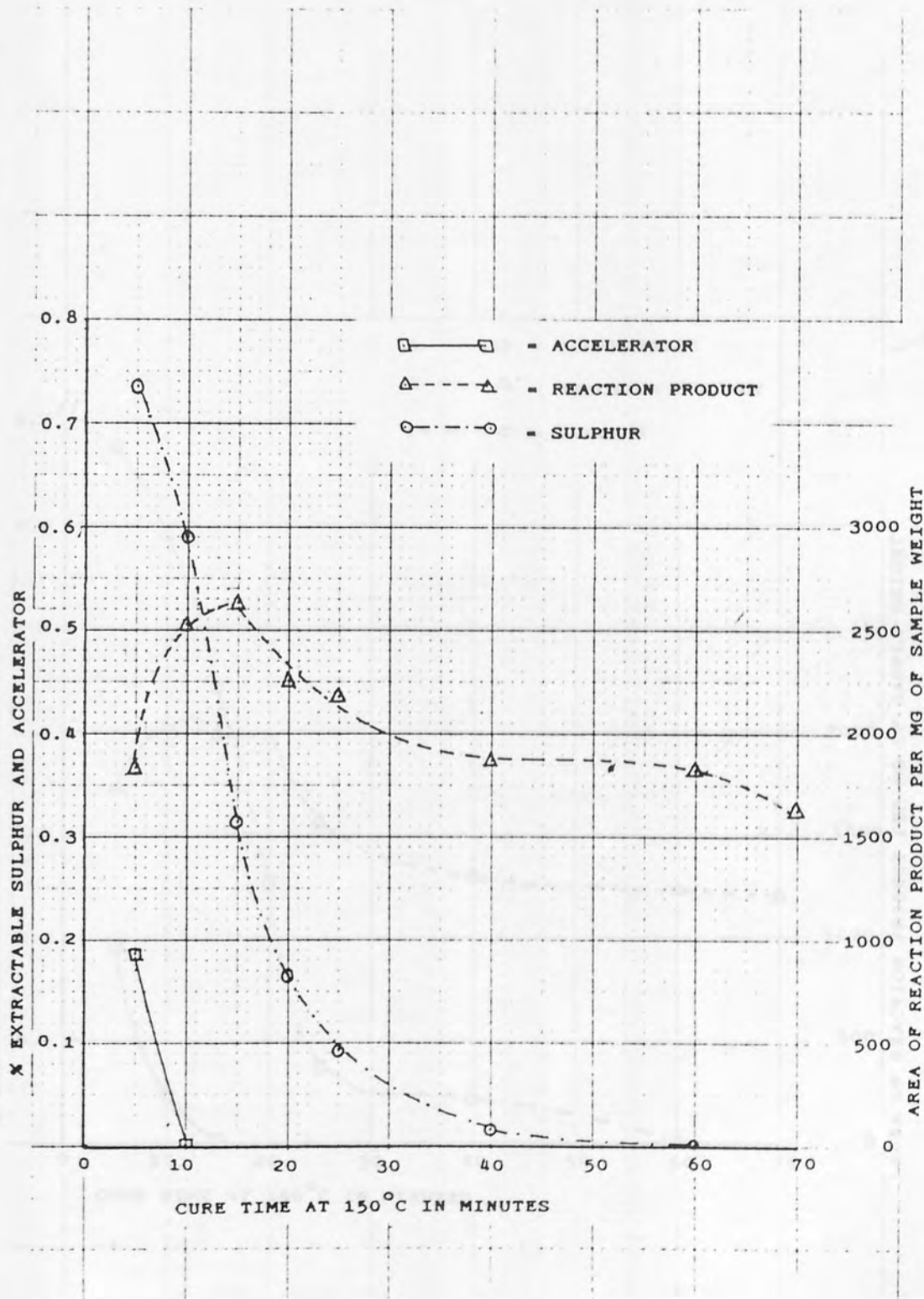

FIGURE 81

RESULTS FOR AMOUNTS OF SULPHUR, ACCELERATOR AND REACTION
 PRODUCT, FOUND IN AN5910/E. SHOWN IN GRAPHICAL FORM

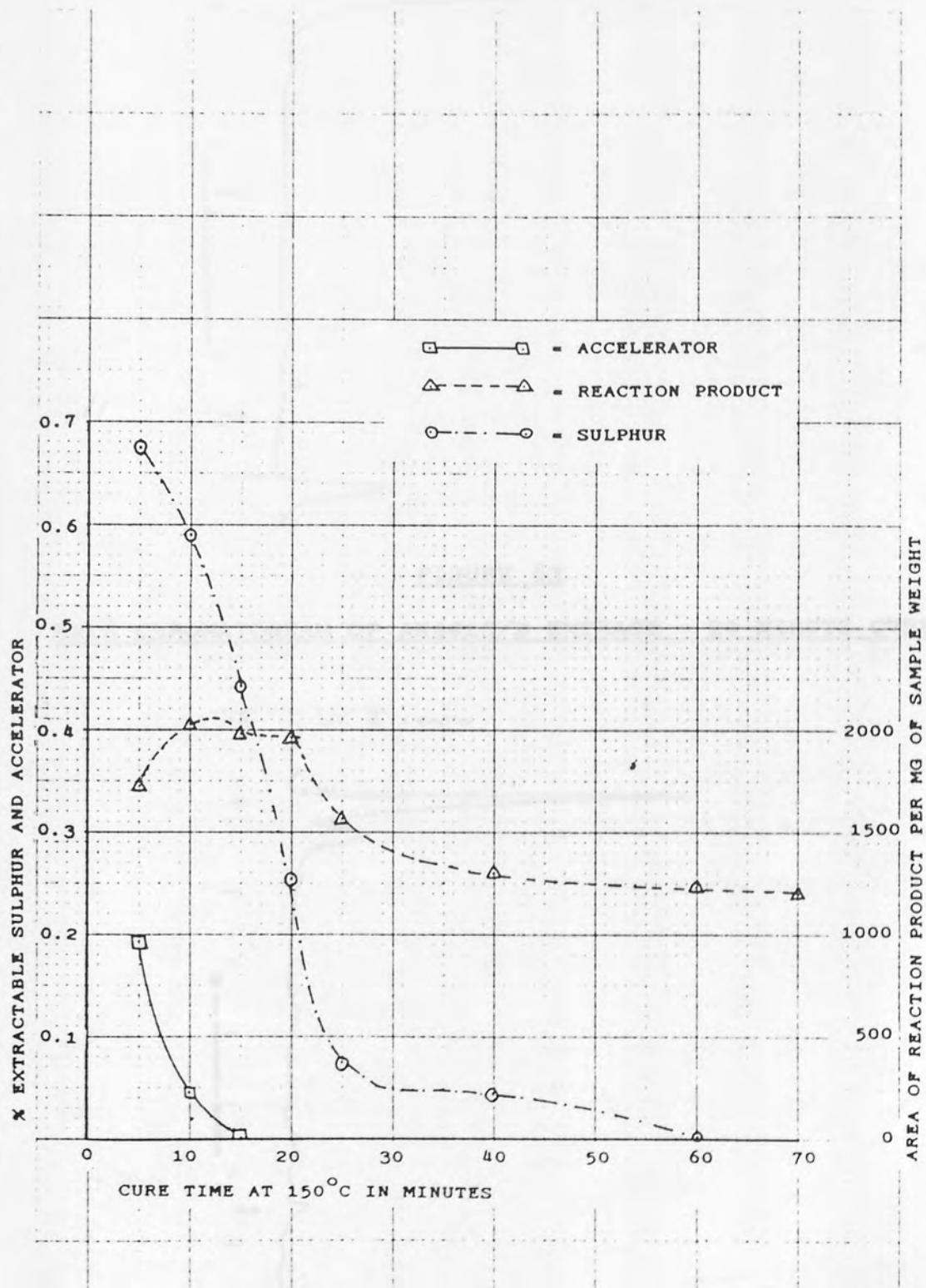

FIGURE 82

HPLC CHROMATOGRAM OF AN5910/A EXTRACT - 20 MINUTE CURE

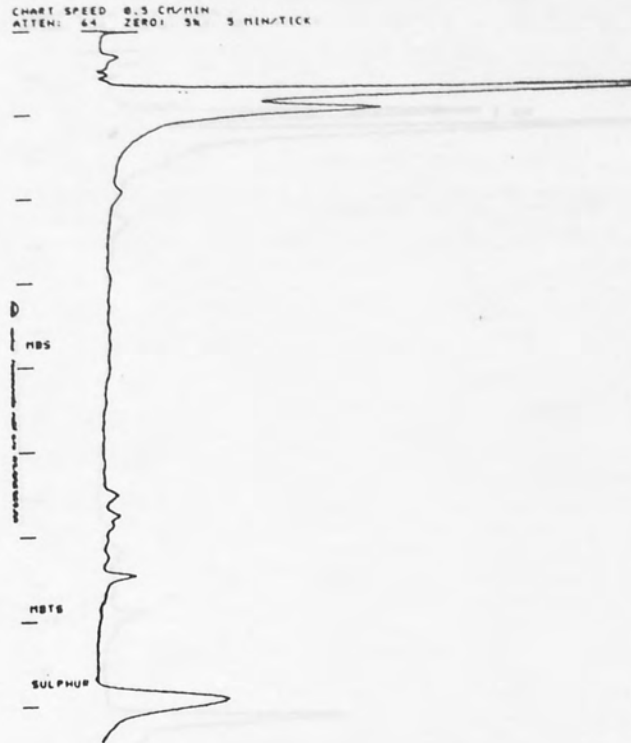

FIGURE 83

HPLC CHROMATOGRAM OF AN5910/B EXTRACT - 20 MINUTE CURE

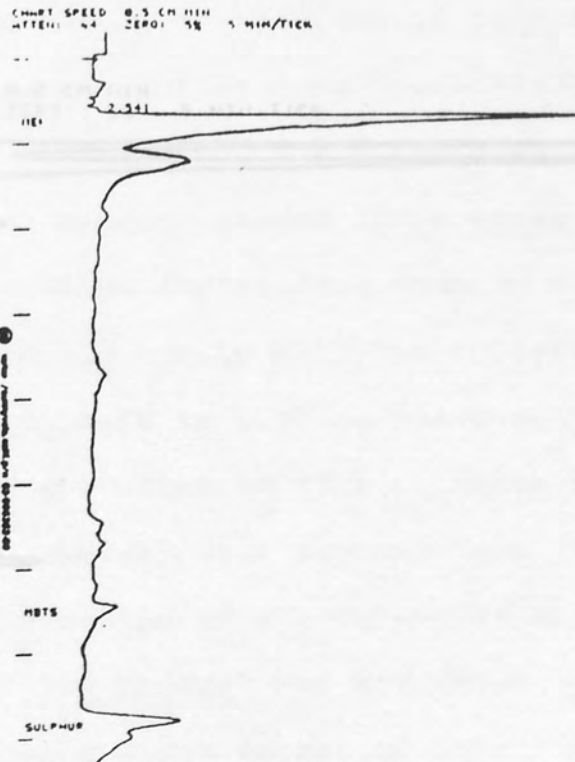

FIGURE 84

HPLC CHROMATOGRAM OF AN5910/C EXTRACT - 20 MINUTE CURE

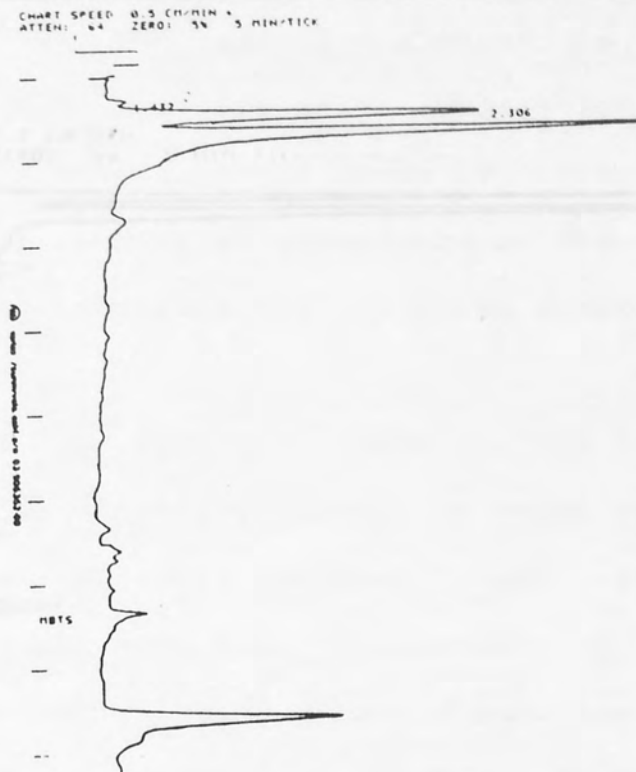

FIGURE 85

HPLC CHROMATOGRAM OF AN5910/D EXTRACT - 20 MINUTE CURE

CHART SPEED 0.2 CM/MIN
ATTEN: 64 ZERO: 5% 5 MIN/TICK

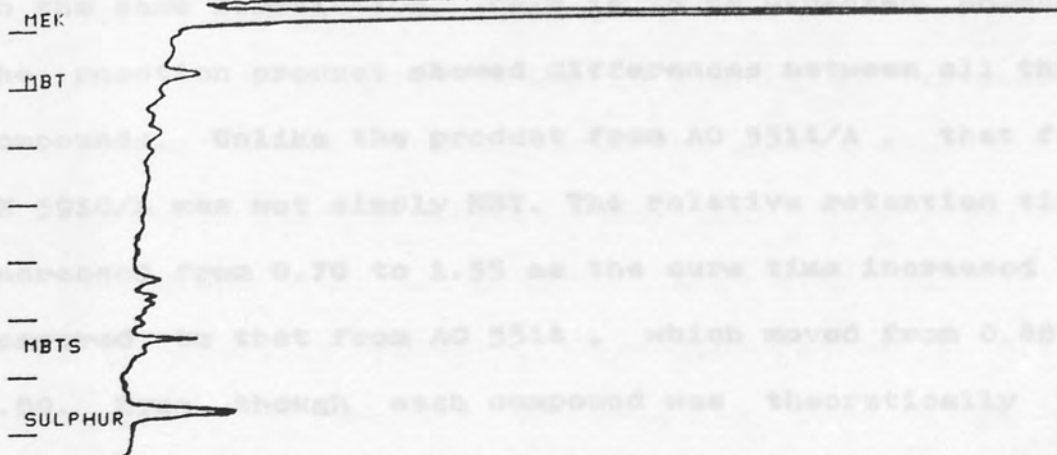
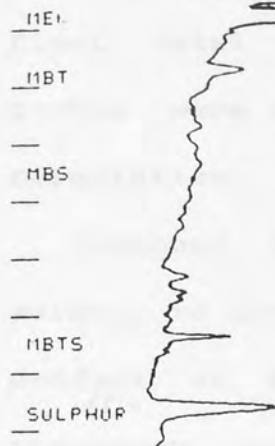

FIGURE 86

HPLC CHROMATOGRAM OF AN5910/E EXTRACT - 20 MINUTE CURE

CHART SPEED: 0.2 CM MIN
ATTEN: 64 ZERO: 5% 5 MIN TILT



5.5.2. Discussion of AN 5910/A-E Results

The results for both sulphur and accelerator amounts found in AN 5910/A are comparable to those from AO 5514 and AO 5514/A at similar cure times. As these are all made to the same formulation, this is to be expected. However, the reaction product showed differences between all three compounds. Unlike the product from AO 5514/A, that from AN 5910/A was not simply MBT. The relative retention times increased from 0.70 to 1.55 as the cure time increased as compared to that from AO 5514, which moved from 0.48 to 1.00. Even though each compound was theoretically the same, the reaction of the curatives and the subsequent breakdown of the product was not consistent. In all cases however, the maximum amount of reaction product occurred

at the point where the accelerator content became zero and this coincides with the onset of crosslinking. It is apparent that the reaction product is a crosslinking precursor and that its exact composition and decay does not appear to affect the speed of crosslinking or the final total number of crosslinks as the rheometer cure curves were identical for all three compounds of the same formulation.

Compound AN 5910/B, which had the lowest ratio of sulphur to accelerator, showed no evidence of a reaction product or MBT being produced at all. Any crosslinking precursor may have been too unstable to remain in the solvent extract. This compound gave the lowest maximum torque level at 8.13 N.m., which was to be expected from the low initial sulphur level.

Compound AN 5910/C, which had the highest sulphur level, gave a very consistent relative retention time for the reaction product, showing that it was probably of a consistent chemical structure.

Compound AN 5910/D, which had the highest sulphur to accelerator ratio, showed that the accelerator content fell to zero after 10 minutes cure time. This rapid decay of the accelerator was not coincident with the maximum level of reaction product, which occurred at 15 minutes cure time. The amounts of reaction product in both compounds AN 5910/D and /E, remained at a higher level than the other compounds after 70 minutes of cure. The

fall in the sulphur amount of these two compounds did not show the flat plateau from 10 to 15 minutes seen in the first three compounds, but fell in a smooth curve right down to zero. This would suggest that the sulphur was being used in forming crosslinks as soon as it was liberated from the complex and that the crosslinking efficiency was high.

It is apparent that the behaviour of the curative system in SBR compounds, follows closely that of natural rubber compounds. In the paper by Campbell and Wise (50), is shown a diagram of the analysis of an MBTS accelerated natural rubber compound. The depletion of sulphur with the build-up of extractable MBT, show similar curve shapes to those found from the analysis of AO 5514 and AN5910 compounds. This diagram is shown as Figure 87.

FIGURE 87

ANALYSIS OF AN MBTS ACCELERATED NATURAL RUBBER COMPOUND
AS DETERMINED BY CAMPBELL AND WISE

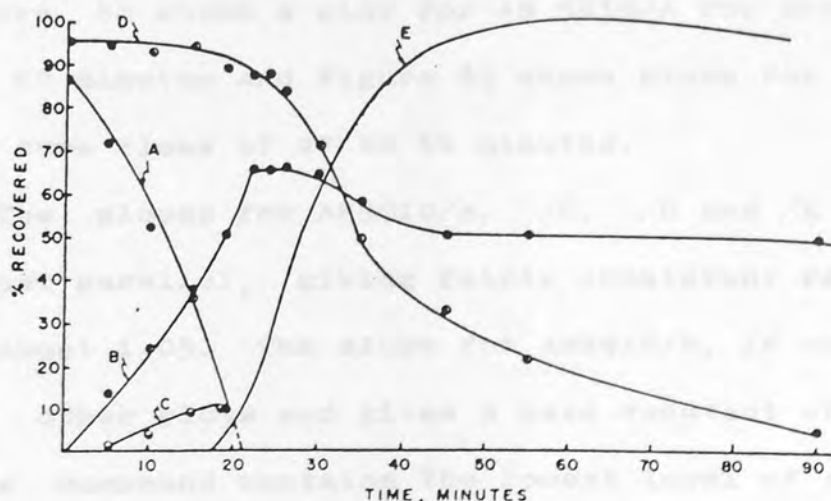

Fig. 2.—Some analyses of MBTS-zinc stearate-sulfur-natural rubber vulcanizates at 138° C. A—BTSS, SBT curve; B—Total extractable MBT curve; C—RS, SBT curve; D—Soluble sulfur curve; E—Vulcanometer curve.

5.5.3. Kinetics of the Crosslinking Reaction

Coran (53), showed that the crosslinking reaction was a first order reaction, but only after the near complete disappearance of the accelerator. The rate constant of the crosslinking reaction, k_2 , (see page 48) could be determined from the rheometer results. The reaction through k_2 , to form the free radical precursor, is rate controlling for the crosslinking reaction, as the reactions through k_3 and k_4 are assumed to be very fast. By following the method given by Coran, a plot was made of $\ln(R_\infty - R_t)$ against time of cure, where R_∞ is the maximum torque value. The time required for the crosslinking to become an unperturbed first order reaction is assumed to be the time - t_{dis} required for the depletion of the accelerator. The results of the plots for AN 5910/A - /E, gave straight lines for the cure times between 27 and 40 minutes. This agreed with the results obtained by Coran and showed that the crosslinking in SBR rubber compounds is a first order reaction as in natural rubber compounds. Figure 88 shows a plot for AN 5910/A for cure times of 5 to 40 minutes and Figure 89 shows plots for AN 5910/A-E for cure times of 27 to 40 minutes.

The slopes for AN5910/A, /C, /D and /E compounds are almost parallel, giving fairly consistent rate constants of about 1.05. The slope for AN5910/B, is not parallel to the other plots and gives a rate constant of 1.177min^{-1} . This compound contains the lowest level of sulphur which probably explains the slower rate of reaction.

FIGURE 88

PLOT OF RESULTS FROM RHEOMETER FOR AN5910/A COMPOUND
TO SHOW THE CROSSLINKING RATE CONSTANT

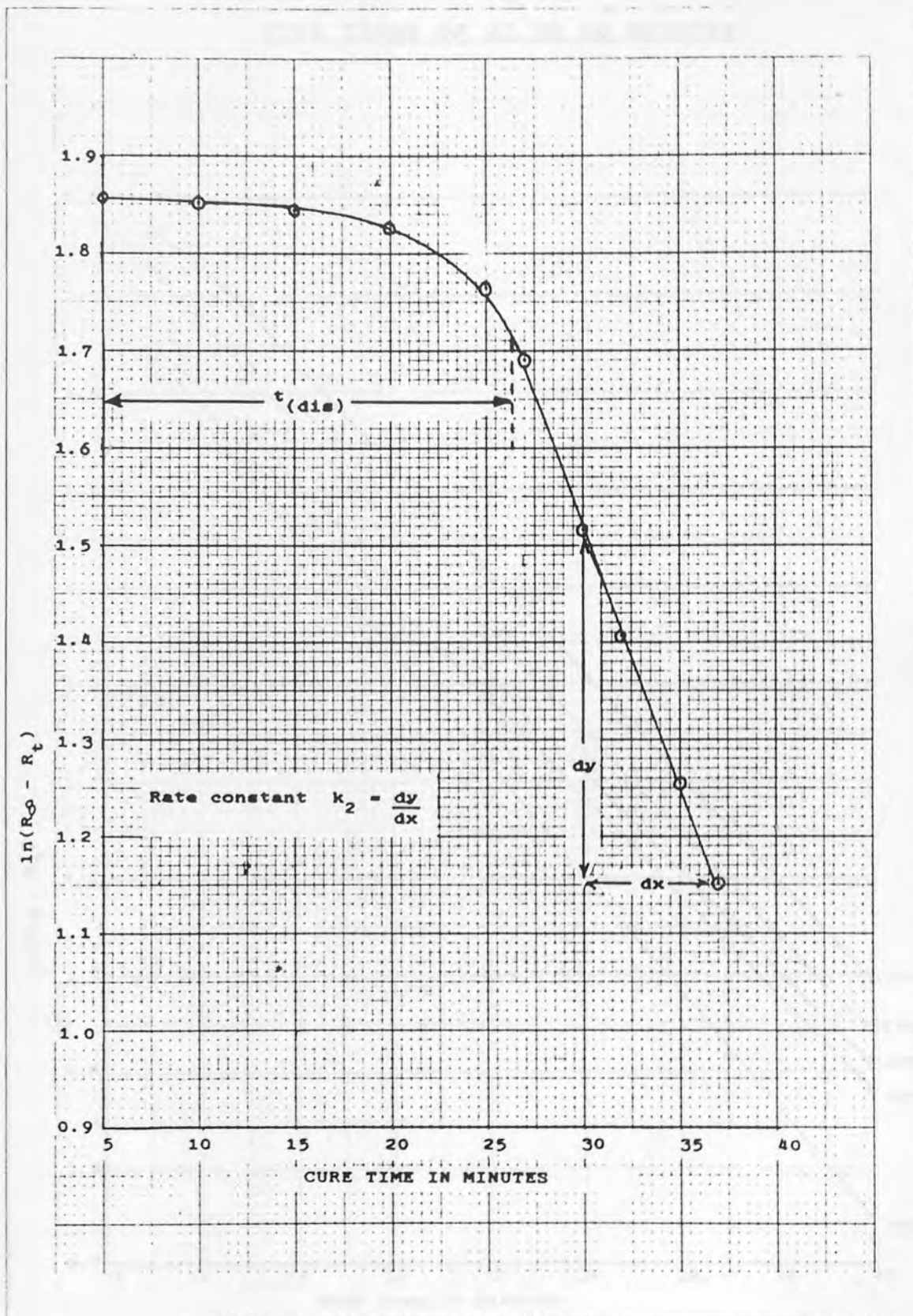
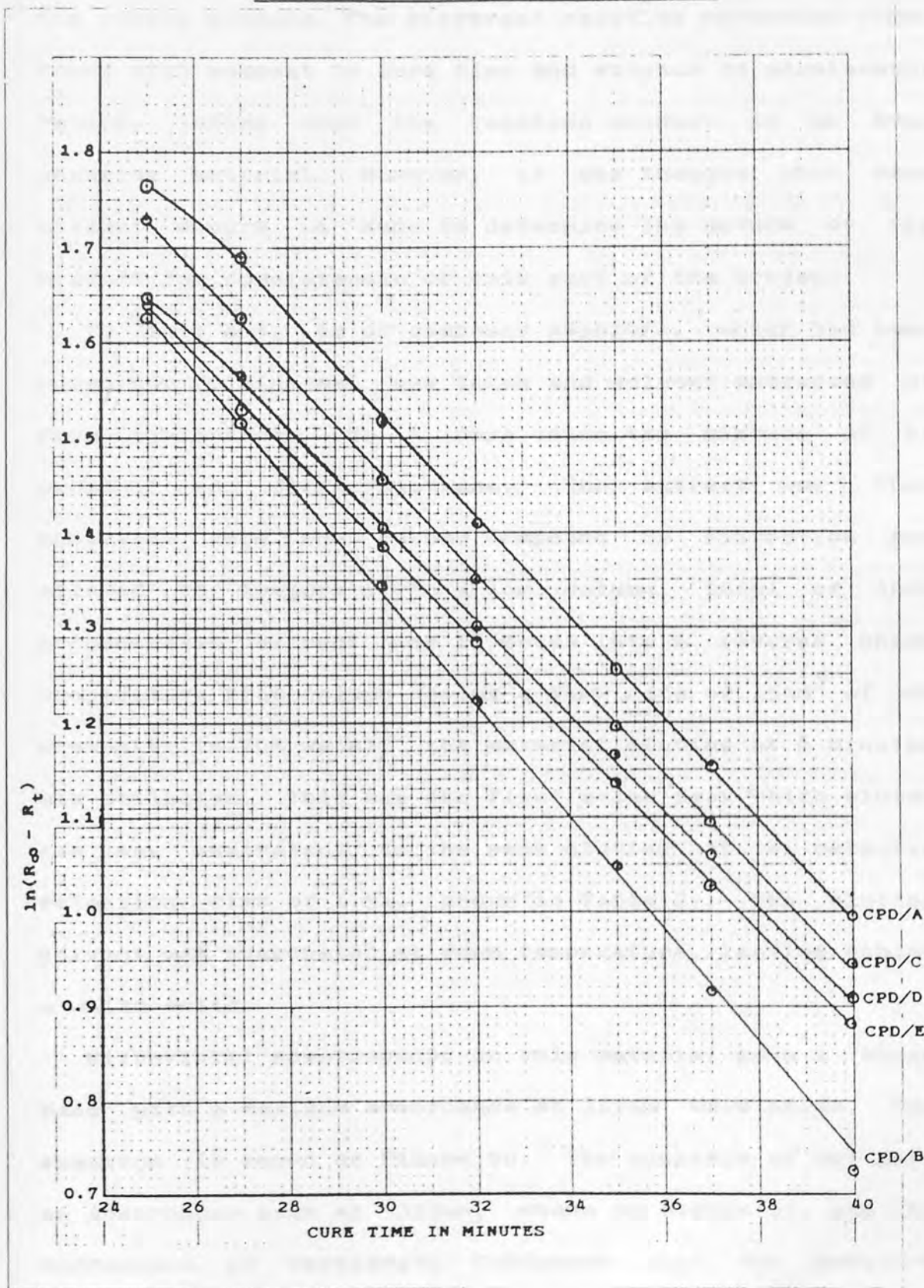

FIGURE 89

LOT OF RESULTS FROM THE RHEOMETER FOR AN5910/A -/E
COMPOUNDS SHOWING THE CROSSLINKING RATE CONSTANT FOR
CURE TIMES OF 27 TO 40 MINUTES



5.6 Analysis of the Reaction Product

It is beyond the scope of this project to analyse fully all the reaction products produced in the compounds during the curing process. The different relative retention times found with respect to cure time and sulphur to accelerator ratios, infers that the reaction product is an ever changing material. However, it was thought that some attempt should be made to determine the nature of the product for completeness of this part of the project.

To this end, 6g of compound AN5910/A, which had been cured for 70 minutes, was taken and solvent extracted at room temperature for 4 days using the mixture of 2-propanol and dichloromethane. The extract was then separated from the rubber compound by filtration and allowed to evaporate to a low volume. 500 μ l of this concentrated extract was injected into a reverse phase preparative HPLC column. Using a flow rate of 15cm³ of 30% acetonitrile/70% water, the material eluting at 6 minutes was collected. This was the first major peak which eluted and was equivalent to the peak eluting at a relative retention time of 1.51, shown in Table 27. The eluting solvent was evaporated at room temperature, leaving behind a white solid.

Ultraviolet spectroscopy on this material gave a broad band with a maximum absorbance at 315nm wavelength. The spectrum is shown as Figure 90. The spectrum of MBT gave an absorbance peak at 328nm, shown as Figure 91, and the difference in wavelength indicated that the reaction

product was not simply MBT. Fourier transform infrared spectroscopy gave a spectrum for the reaction product (Figure 92) which was comparable to that given by MBS (Figure 93) in many respects. Infrared spectra of MBTS (Figure 94) and MBT (Figure 95), showed differences in the 900 to 1500 wavenumber region to the reaction product. The major difference between the spectra of the reaction product and MBS was a peak from the unknown at about 1700 wavenumbers which was not present in the MBS spectrum. A mixture of MBS and sulphur was heated until both materials had melted, then cooled and an infrared spectrum obtained. This spectrum, shown as Figure 96, showed a strong peak at 1660 wavenumbers comparable to a peak given at the same frequency by morpholine. (Figure 97) The strong peak in the reaction product, however, was at 1696 wavenumbers and was probably C=O stretch whereas the band at 1660 cm^{-1} from morpholine was possibly due to the ring -C-O-C-. There is a possibility that if a number of sulphur atoms had been inserted into the MBS structure, lengthening the distance between the benzthiazole ring and the morpholine group, that this could cause a frequency shift of the -C-O-C- from 1660 to 1696 cm^{-1} . If this was the case, then a probable structure for the reaction product could be:-

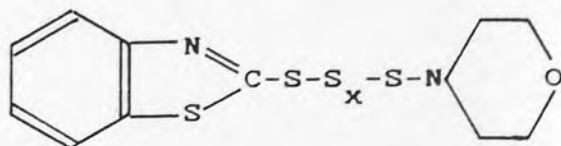

(Structure A)

An alternative structure would have to be proposed if the peak at 1696cm^{-1} was a carbonyl group. This would indicate that stearic acid or zinc stearate was attached to the benzthiazole group giving a large complicated structure, such as that proposed by Bateman (9) and shown on page 34. (Structure B)

The determination of the sulphur content of the reaction product could help to differentiate between these two types of material. An analysis was carried out using the Leco sulphur analyser and gave results of 45.1% and 45.5%. Structure A would have sulphur contents between 33.8% and 63.4%, depending on how many additional sulphur atoms (1 to 8) were inserted into the molecule. Structure B would have sulphur contents ranging from 9.9% to 20.8% with 1 to 8 additional sulphur atoms, based on an original molecular weight of 1588 for the complex. The sulphur results of 45.1% and 45.5% suggest that the reaction product is likely to be structure A, with an additional 3 sulphur atoms which would give a sulphur content of 45.9%.

FIGURE 90

ULTRAVIOLET SPECTRUM OF THE REACTION PRODUCT

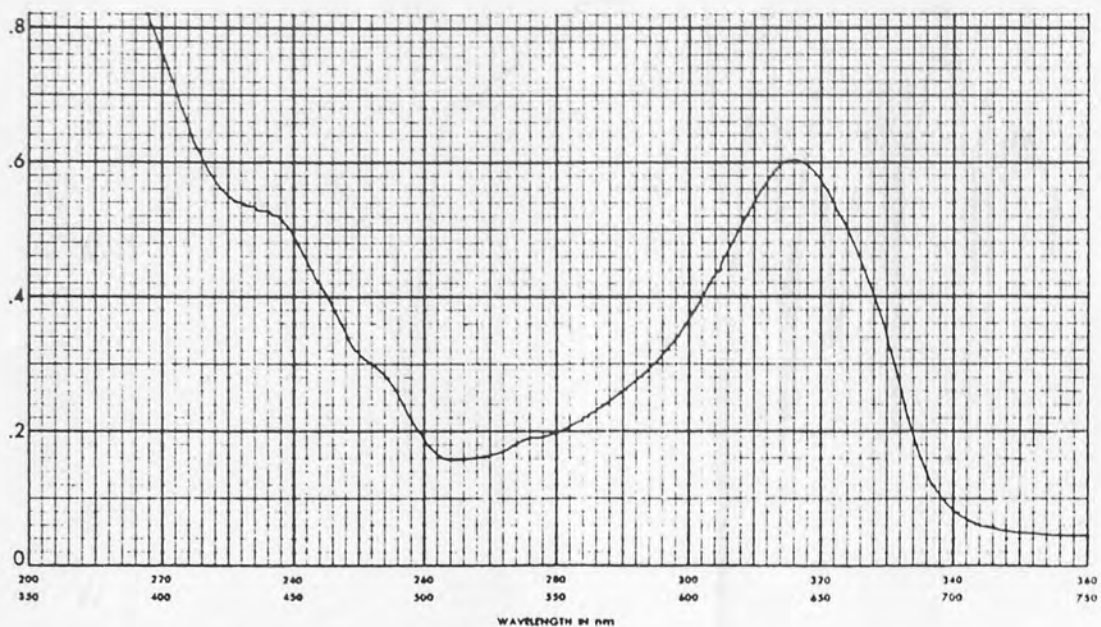

FIGURE 91

ULTRAVIOLET SPECTRUM OF MBT

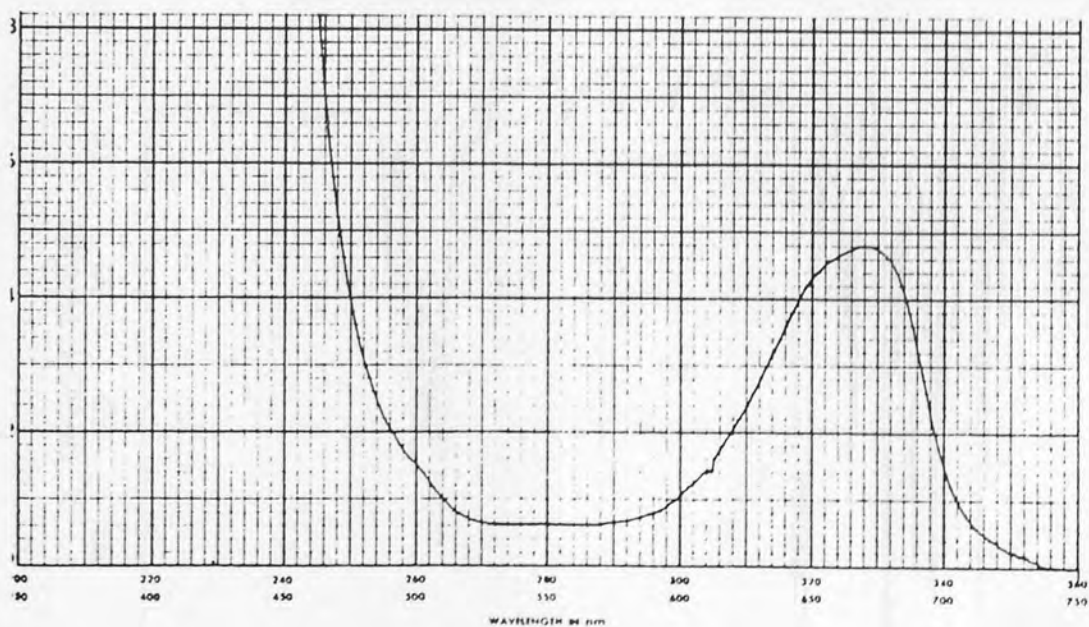

FIGURE 92

FTIR SPECTRUM OF REACTION PRODUCT

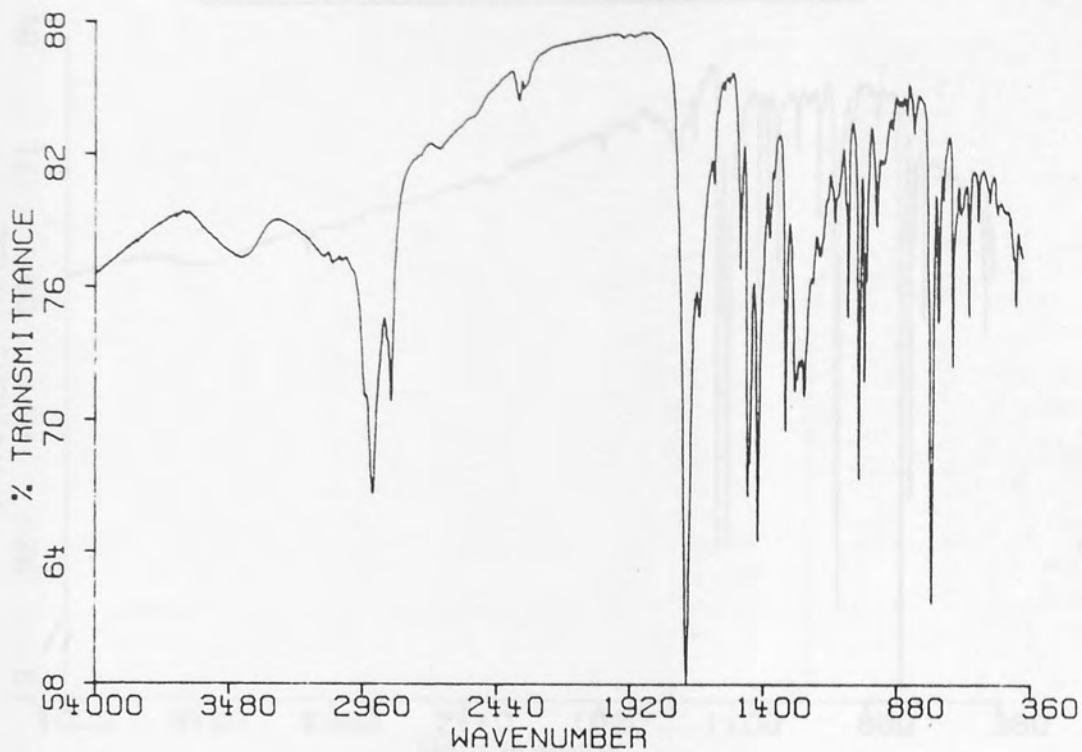

FIGURE 93

FTIR SPECTRUM OF MBS ACCELERATOR

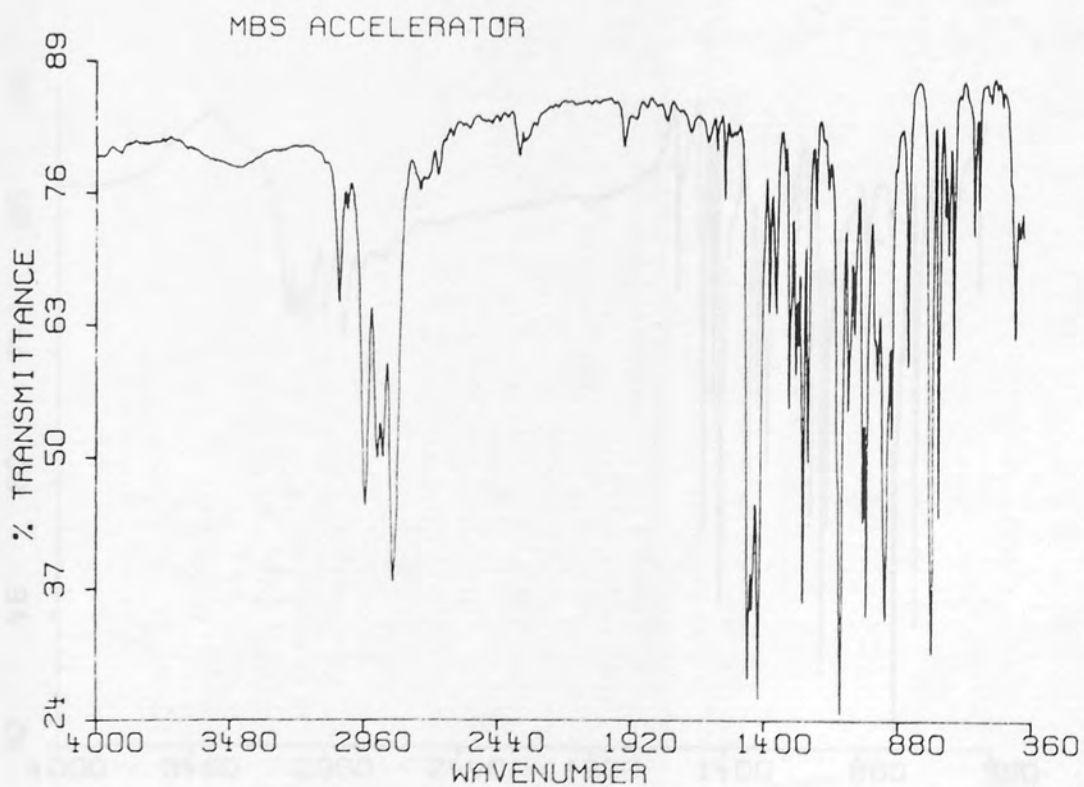

FIGURE 94

FTIR SPECTRUM OF MBTS ACCELERATOR

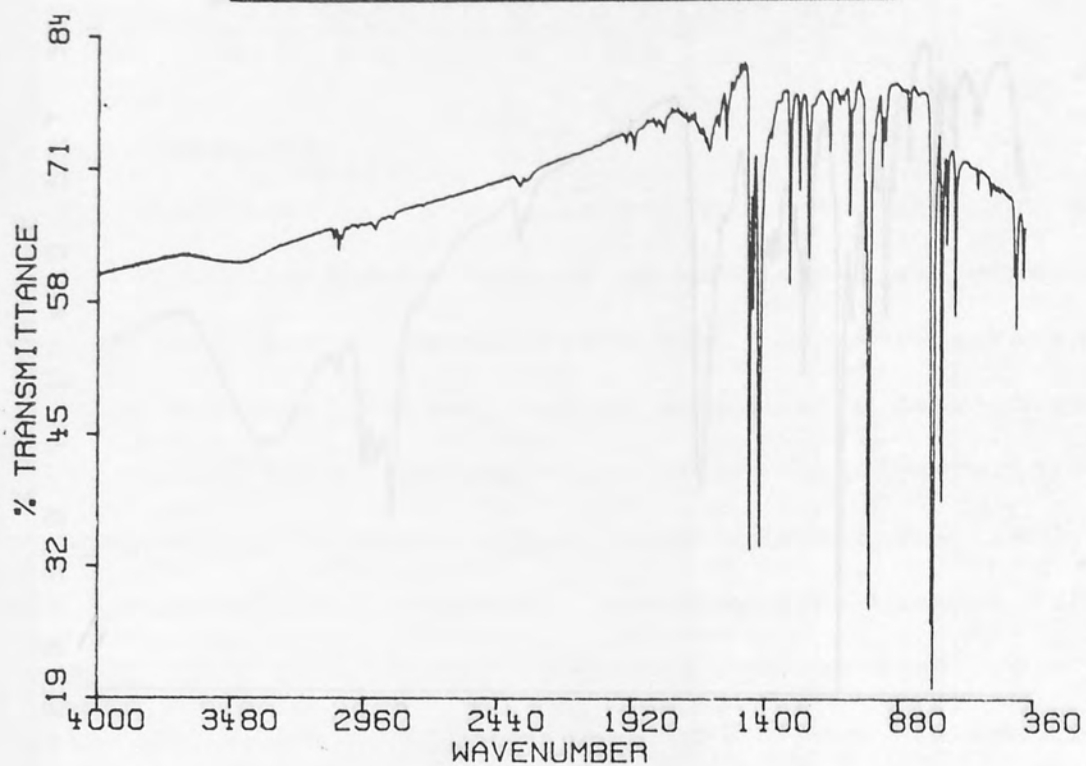

FIGURE 95

FTIR SPECTRUM OF MBT ACCELERATOR

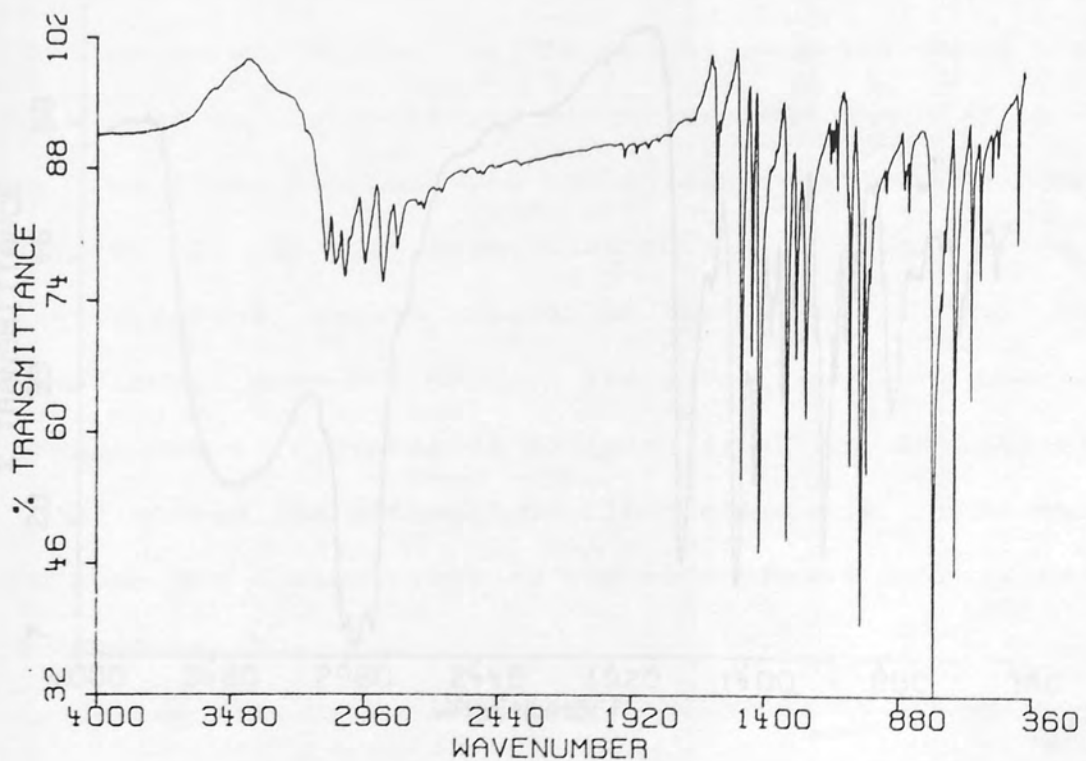

FIGURE 96

FTIR SPECTRUM OF A SULPHUR/MBS MELT

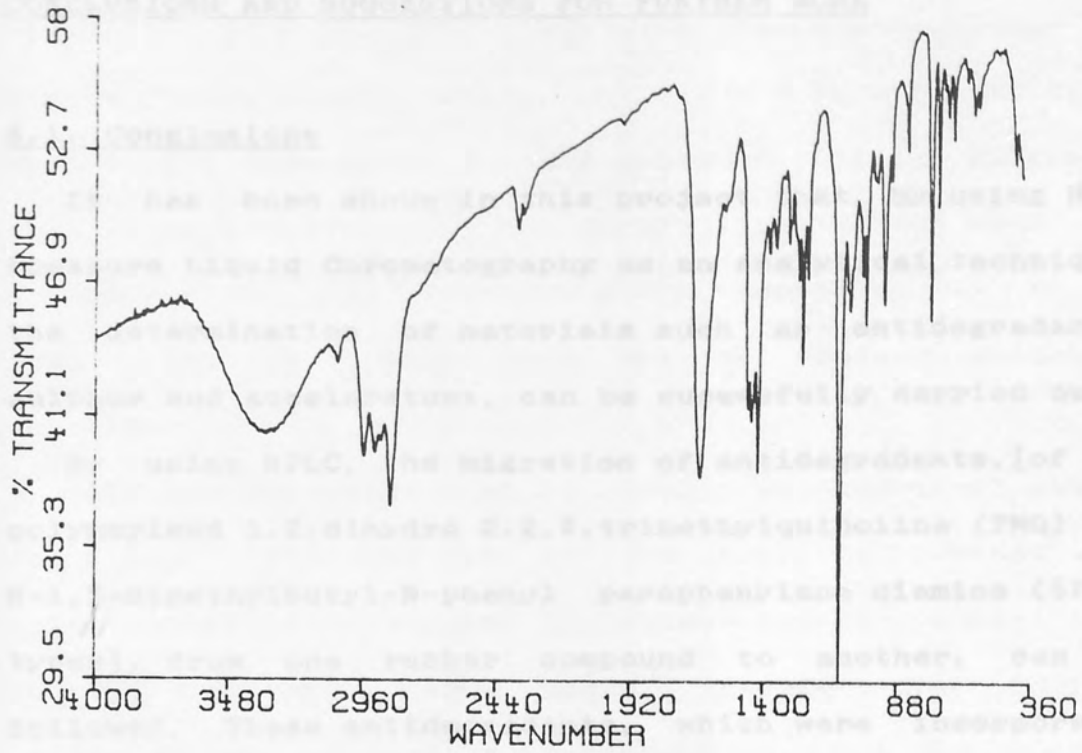
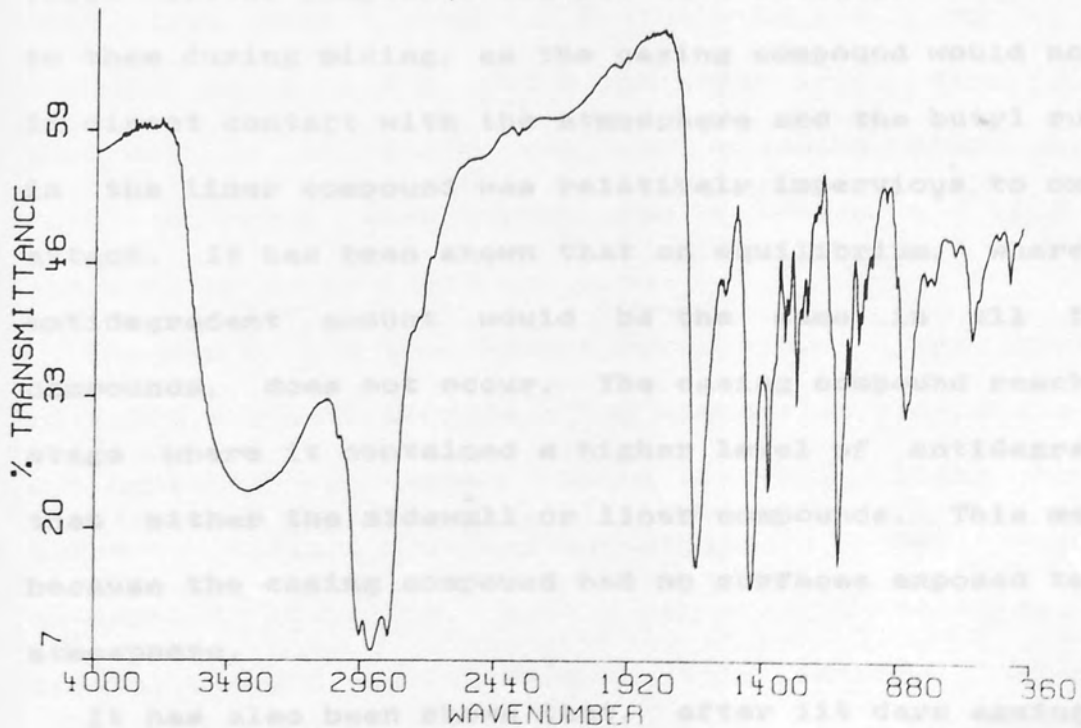

FIGURE 97

FTIR SPECTRUM OF MORPHOLINE



CHAPTER 6

CONCLUSIONS AND SUGGESTIONS FOR FURTHER WORK

6.1. Conclusions

It has been shown in this project that, by using High Pressure Liquid Chromatography as an analytical technique, the determination of materials such as antidegradants, sulphur and accelerators, can be successfully carried out.

By using HPLC, the migration of antidegradants, [of the polymerised 1.2.dihydro 2.2.4.trimethylquinoline (TMQ) and N-1,3-dimethylbutyl-N-phenyl paraphenylene diamine (6PPD) types], from one rubber compound to another, can be followed. These antidegradants, which were incorporated into a sidewall compound, migrate not only to the surface, but also move into adjacent casing and liner compounds. These latter compounds did not have antidegradants added to them during mixing, as the casing compound would not be in direct contact with the atmosphere and the butyl rubber in the liner compound was relatively impervious to oxygen attack. It has been shown that an equilibrium, where the antidegradant amount would be the same in all three compounds, does not occur. The casing compound reached a stage where it contained a higher level of antidegradant than either the sidewall or liner compounds. This may be because the casing compound had no surfaces exposed to the atmosphere.

It has also been shown that, after 114 days ageing at

50°C and 95% relative humidity, the amount of solvent extractable 6PPD antidegradant in the sidewall compound had fallen to zero. When this aged sample was exposed to 50pphm ozone concentration, it did not show any evidence of cracking even after 2 years exposure. It is suggested that some antidegradant had chemically combined with the polymer chain and, although not extractable, was in an active form and could still act to prevent oxidative scission.

HPLC has also been used to develop an analytical method for the determination of the type and amount of sulphenamide accelerator in vulcanised compounds. The amine liberated from such accelerators during vulcanisation of the rubber compound, can be solvent extracted and separated from other extractable materials. Conversion of the amine into an intense yellow coloured derivative with 1-chloro-2,4-dinitrobenzene, led to its identification and quantitation using HPLC. This type of analysis is of great use for checking that service returned tyres were formulated correctly and for the analysis of competitors tyres.

The use of low temperature pyrolysis, in the presence of solid sodium hydroxide, has shown that the part of the sulphenamide accelerator which eventually links to the polymer chain, (mercaptobenzthiazole - MBT) can be determined. HPLC is, again, a suitable technique for separation and identification of this material. Although not made quantitative, it could help to confirm the type

of accelerator used in a vulcanisate.

The chemical changes taking place during the vulcanisation of styrene-butadiene polymer, in rubber compounds containing sulphur, MBS accelerator, zinc oxide, stearic acid and carbon black have been examined. It has been shown that solvent extraction and subsequent analysis of the extract by HPLC, allows the determination of sulphur and accelerator to be carried out. By vulcanising the rubber compounds for varying lengths of time, the rates at which the accelerator breaks down and the sulphur is used up in the crosslinking reaction can be measured. The changing retention time of the reaction product between the sulphur and accelerator, particularly in AN5910/A compound, shows that it is an ever changing material. It has often been postulated that the cross-linking precursor was not a single unchanging product and the evidence from the HPLC analysis shows this to be correct. The changing retention time is the first direct proof that the cross-linking precursor changes with cure time and the analytical method used enables individual precursors to be isolated and analysed. The effects of changing the accelerator to sulphur ratio were investigated and it has been shown that the rate constant for the crosslinking reaction was constant over a wide range of such ratios. Only when the sulphur content fell below 1% by weight of the rubber compound, with a ratio of accelerator to sulphur of 1:1.3, did the rate constant

fall.

It has also been demonstrated that the crosslinking reaction for styrene-butadiene rubber compounds was a first order reaction, but only after the initial period when the accelerator decays to zero. Limited chemical analysis of the reaction product, formed between the sulphur and accelerator during the vulcanisation process, suggested that it was probably a polythiosulphenamide product containing 3 additional sulphur atoms. At the end of a 70 minute cure at 150°C, some of this reaction product was still present in the rubber compound indicating that not all of the available sulphur had been used in the crosslinking reaction. As the torque value had reached a maximum, as shown by a rheometer, at the 70 minute cure time, this would suggest that the crosslinking was also at a maximum. Hence the additional sulphur in the polythiosulphenamide may link to the polymer chain as an MBT - sulphur complex in the form of a pendant group.

6.2. Suggestions for Further Work

1. Work could be carried out to investigate whether antidegradants do attach themselves to the polymer network and thus become insoluble in solvents. This may be possible by using just a mixture of polymer and antidegradant, then ageing the mixture until no further antidegradant is extractable. Low temperature pyrolysis mass spectrometry or nuclear magnetic resonance may then

be used to determine whether any antioxidant remains in the polymer.

2. The study of antidegradant migration could be carried further by investigating a range of p-phenylenediamine derivatives to determine whether the molecular weight was a factor in the rate of migration. The matrix could be changed by introducing SBR/NR mixtures to alter the polarity of the polymer system which could affect the migration speed. The polarity of the matrix could also be changed by introducing oil extension and using oils of varying aromaticity. The change in polarity could alter the solubility of the antidegradants and hence the migration rate. The use of highly polar polymers, such as neoprene, could be investigated as barriers to migration.

3. The determination of the type of accelerator used in cured rubber compounds has included only the sulphenamides. Further study could include thiuram disulphides and guanidines, although a different approach would be required as such chemicals do not contain amines.

4. In order to better understand the chemical reactions taking place during vulcanisation of rubber compounds, further work could be carried out to identify the intermediate materials produced. The use of HPLC/mass spectrometry could be a useful technique in such a study.

AN5373/B SIDEMALL CPD FROM COMPOSITE BLOCK

200 HOURS AGING

CHART SPEED 8.0 CM/MIN
ATTEN 04 20001 04 0.001 0.01



APPENDIX ONE

HPLC CHROMATOGRAMS OF ANTIDEGRADANTS

IN VARIOUS VULCANISATE EXTRACTS

AN5373/B LINED STD FROM COMPOSITE BLOCK

200 HOURS AGING

CHART SPEED 8.0 CM/MIN
ATTEN 04 20001 04 0.001 0.01



AN5374/B SIDEWALL CPD FROM COMPOSITE BLOCK

200 HOURS AGEING

CHART SPEED 0.2 CM/MIN
ATTEN: 64 ZERO: 5% 5 MIN/TICK

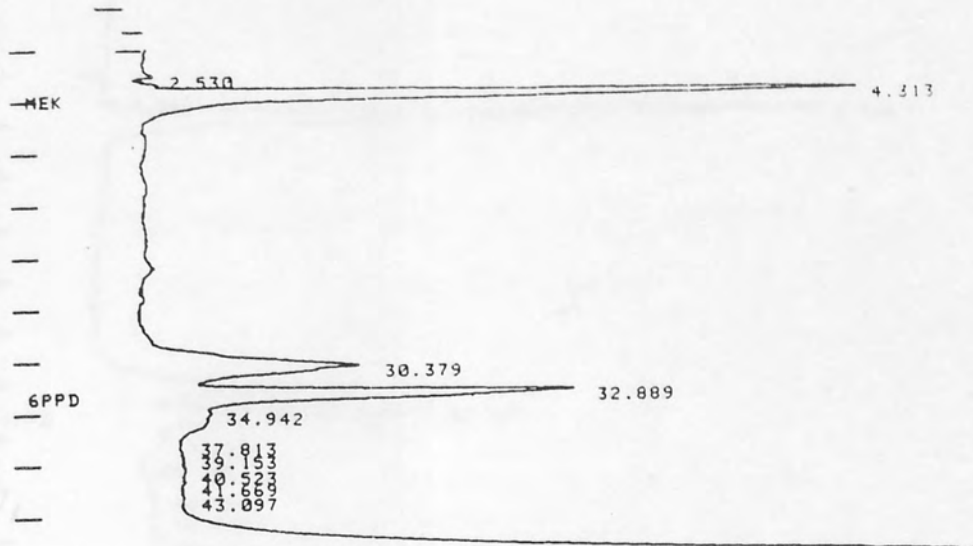

AN5374/B LINER CPD FROM COMPOSITE BLOCK

200 HOURS AGEING

CHART SPEED 0.2 CM/MIN
ATTEN: 64 ZERO: 5% 5 MIN/TICK

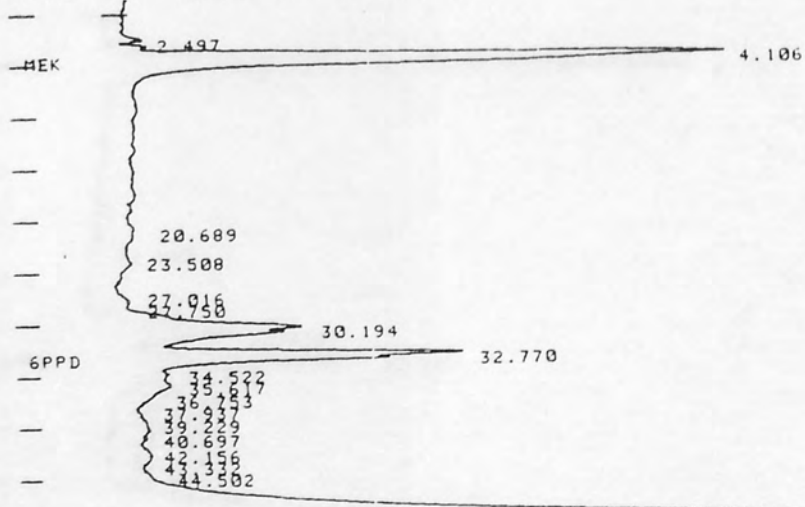

AN5374/B CASING CPD FROM COMPOSITE BLOCK

200 HOURS AGEING

CHART SPEED 0.2 CM/MIN
ATTEN: 64 ZERO: 5% 5 MIN TICK

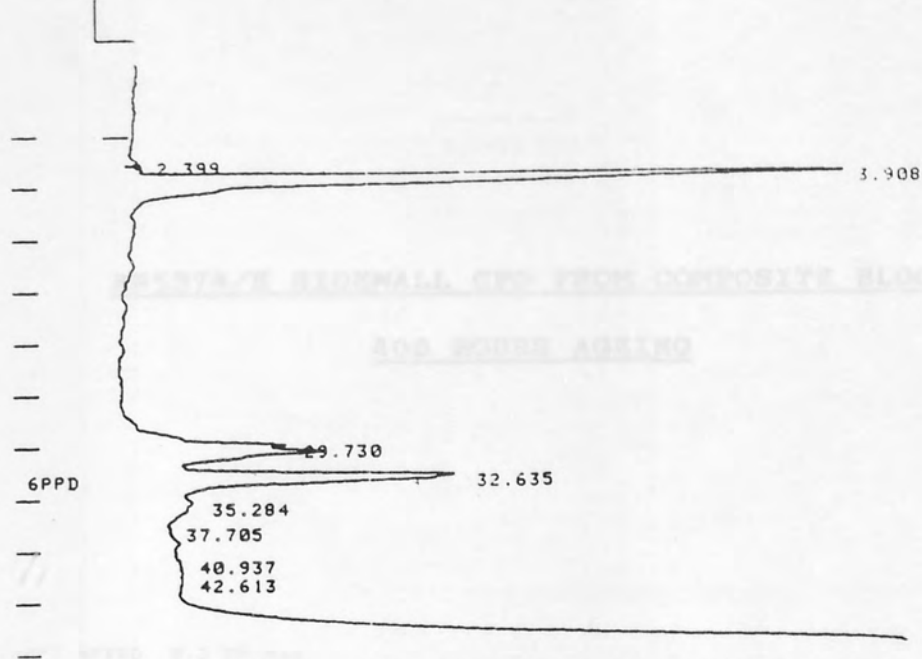

AN5374/B LINER CPD FROM COMPOSITE BLOCK

400 HOURS AGEING

CHART SPEED 0.2 CM/MIN
ATTEN: 64 ZERO: 5% 5 MIN TICK

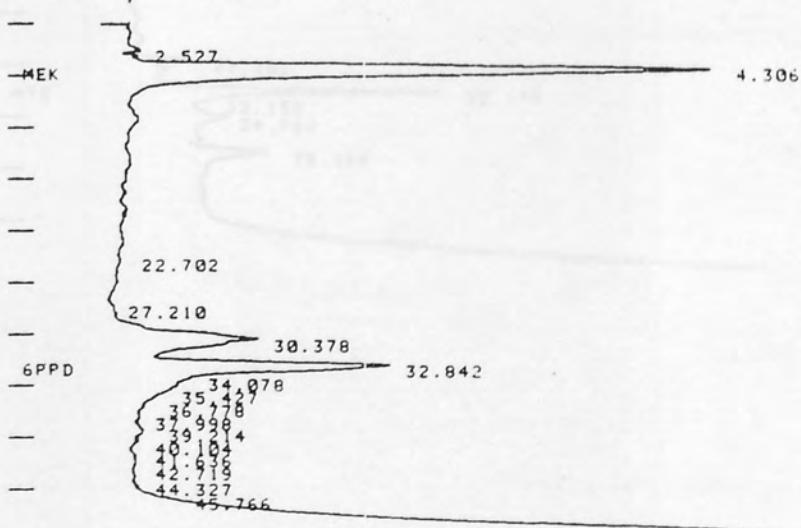

AN5374/E CASING CPD FROM COMPOSITE BLOCK

400 HOURS AGEING

AN5374/E SIDEWALL CPD FROM COMPOSITE BLOCK

400 HOURS AGEING

CHART SPEED 0.2 CM/MIN
ATTEN: 64 ZERO: 5% 5 MIN/TICK

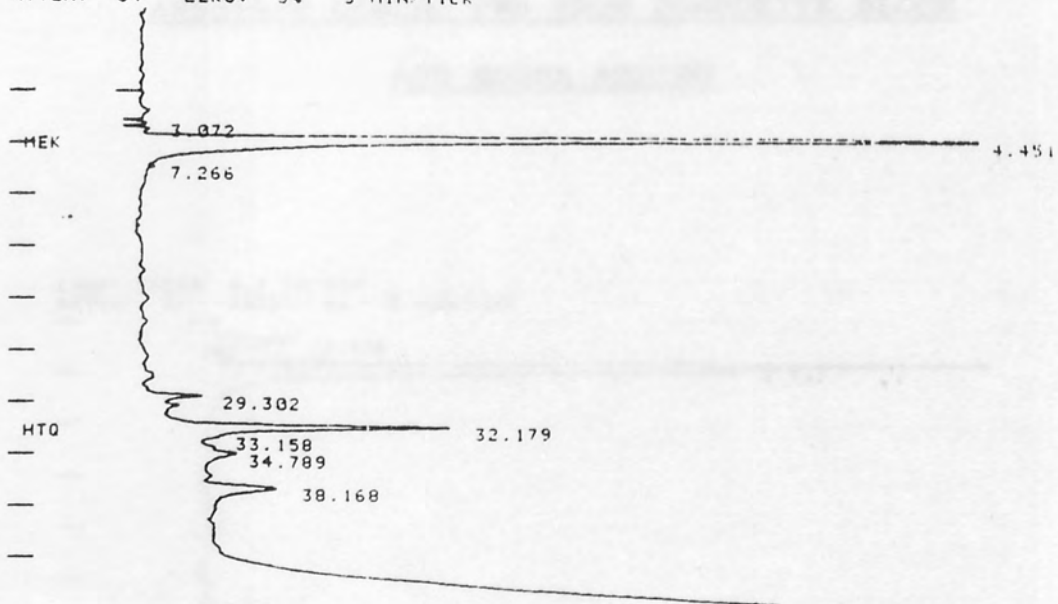

AN5374/E CASING CPD FROM COMPOSITE BLOCK

200 HOURS AGEING

CHART SPEED 0.2 CM/MIN
ATTEN: 64 ZERO: 5% 5 MIN/TICK

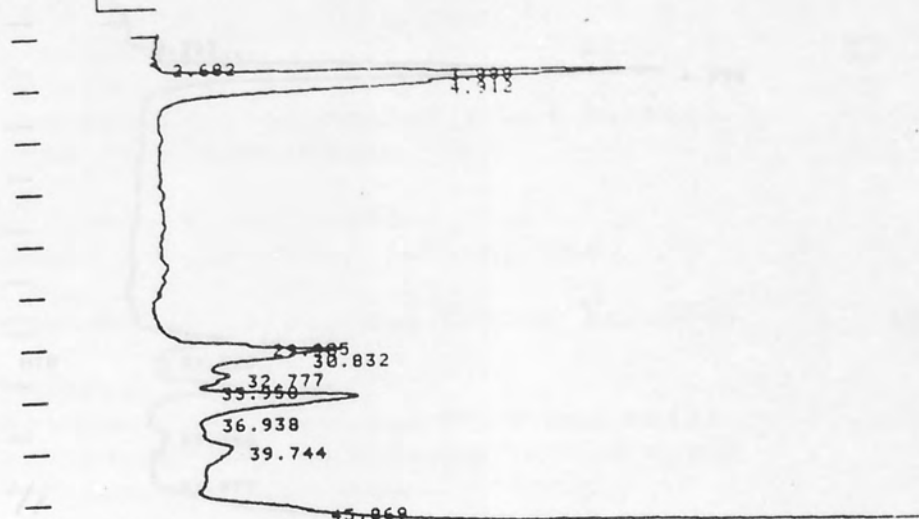

AN5374/E CASING CPD FROM COMPOSITE BLOCK

400 HOURS AGEING

CHART SPEED 0.2 CM/MIN
ATTEN: 64 ZERO: 5% 5 MIN/TICK

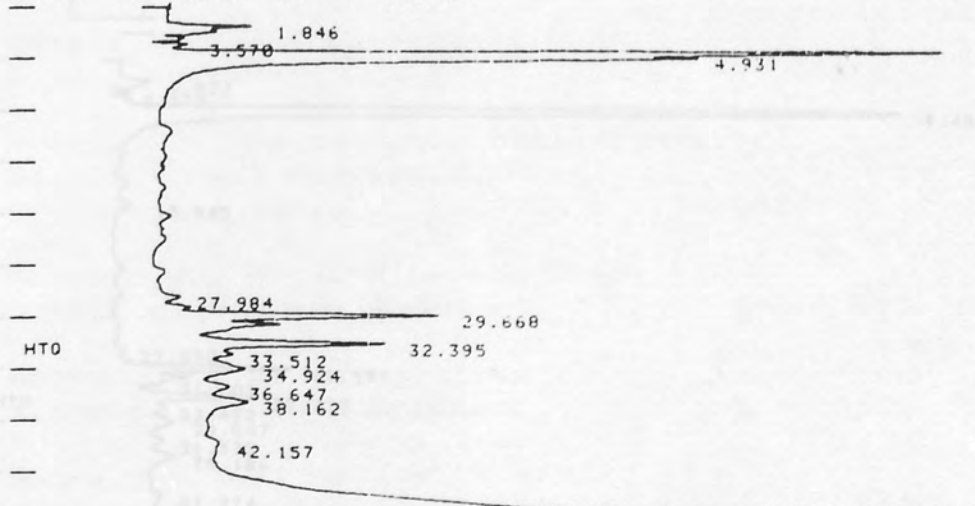

AN5374/E LINER CPD FROM COMPOSITE BLOCK

REFERENCES

200 HOURS AGEING

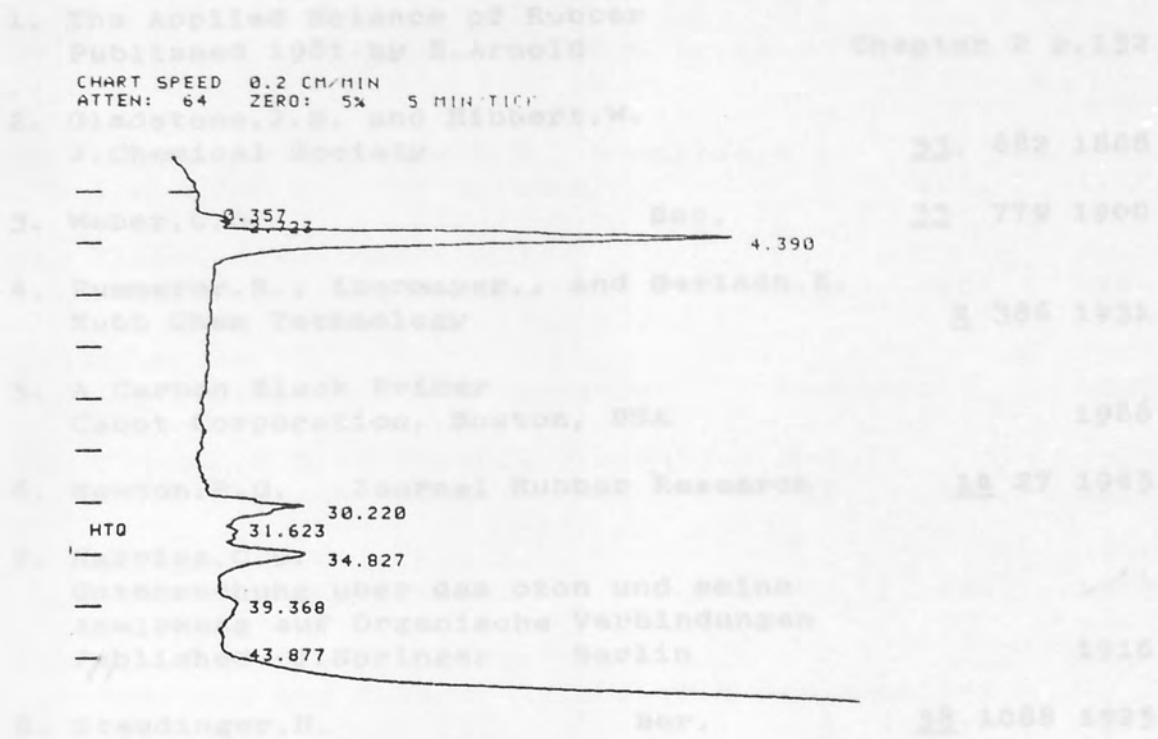

AN53747/E LINER CPD FROM COMPOSITE BLOCK

400 HOURS AGEING

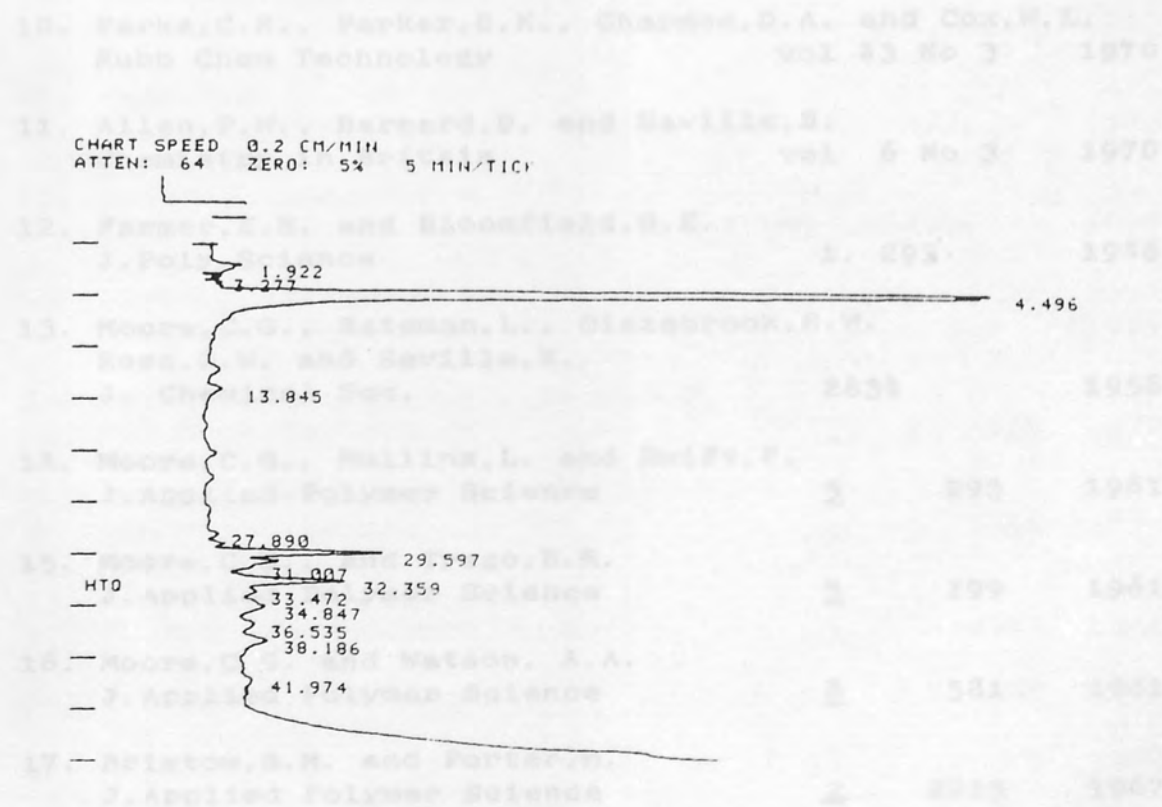

REFERENCES

1. The Applied Science of Rubber
Published 1961 by E. Arnold Chapter 2 p.152
2. Gladstone, J.H. and Hibbert, W.
J. Chemical Society 53, 682 1888
3. Weber, C.O. Ber. 33 779 1900
4. Pummerer, R., Ebermayer, . and Gerlach, K.
Rub Chem Technology 4 386 1931
5. A Carbon Black Primer
Cabot Corporation, Boston, USA 1986
6. Newton, R.G. Journal Rubber Research 14 27 1945
7. Harries, C.D.
Untersuchung uber das ozon und seine
Anwirkung auf Organische Verbindungen
Published J. Springer Berlin 1916
8. Staudinger, H. Ber. 58 1088 1925
9. Bateman, L., Moore, C.G., Porter, M. and Saville, B.
The Chemistry and Physics of Rubber-like Substances
J. Wiley + Son New York 1963
10. Parks, C.R., Parker, D.K., Chapmen, D.A. and Cox, W.L.
Rub Chem Technology vol 43 No 3 1970
11. Allen, P.W., Barnard, D. and Saville, B.
Chemistry in Britain vol 6 No 3 1970
12. Farmer, E.H. and Bloomfield, G.E.
J. Poly Science 1. 293 1946
13. Moore, C.G., Bateman, L., Glazebrook, R.W.
Ross, G.W. and Saville, B.
J. Chemical Soc. 2834 1958
14. Moore, C.G., Mullins, L. and Swift, P.
J. Applied Polymer Science 5 293 1961
15. Moore, C.G., and Trego, B.R.
J. Applied Polymer Science 5 299 1961
16. Moore, C.G. and Watson, A.A.
J. Applied Polymer Science 8 581 1961
17. Bristow, G.M. and Porter, M.
J. Applied Polymer Science 2 2215 1967

18.	Moore, C.G. and Porter, M. J. Applied Polymer Science	<u>2</u>	2227	1967
19.	Porter, M. J. Applied Polymer Science	<u>2</u>	2255	1967
20.	Porter, M., Skinner, T.D., Wheelane, M.A. J. Applied Polymer Science	<u>2</u>	2271	1967
21.	Elliot, D.J., Moore, D.G. J. Applied polymer Science	<u>2</u>	2285	1967
22.	Goodyear, C. Gum Elastic and its Varieties		Newhaven	1855
23.	Russell, R.M., Skinner, T.D., Watson, A.A. Rub. Chem. and Tech.	<u>42</u>	404	1969
24.	Saville, B. Watson, A.A. Rub. Chem and Tech.	<u>40</u>	1 100	1967
25.	Anand, R., Blackley, D.C., Lee, K.S. Plastics and Rubber: Materials + Applications	<u>4</u>	(1) 8	1979
26.	Flory, P.J., Rehner, J. J. Chem Phys.	<u>11</u>	512	1943
27.	Campbell, D.S., Saville, B. Proc. Int Rubber Conf.		Brighton	1968
28.	Kuan, T.H. American Chemical Soc. Paper 51		May	1983
29.	Lautenschlaeger, F.K. Dunlop Research Centre Report S-996		July	1977
30.	Lautenschlaeger, F.K. Rub Chem Technol.	<u>52</u>	213	1979
31.	Lautenschlaeger, F.K., Zeeman, P. Rub Chem Technol.	<u>52</u>	5. 1030	1979
32.	Lautenschlaeger, F.K. Rub Chem Technol.	<u>52</u>	5. 1054	1979
33.	Moore, C.G., Trego, R.R. J. Appl Pol Science	<u>5</u>	299	1961
34.	J. Applied Pol Science	<u>8</u>	1957	1964
35.	Skinner, T.D. Rub Chem Tech	<u>45</u>	182	1972
36.	Scheele, W., Hillmer, K.H. Rub Chem Technol	<u>37</u>	698	1964

37.	Scheele, W., Cherubim, M. Kautschuk Gummi	<u>13</u>	WT49	1960
38.	Lorenz, D., Echte, E. Kautschuk Gummi	<u>10</u>	WT81	1957
39.	Gee, G., Morell, S.H. Rub Chem Technol	<u>25</u>	454	1952
40.	Anfimova, E.A., Petrova, S.B., Lykin, A.S. Int Pol Sci and Techn		Vol 4 No 10	1977
41.	Bateman, L., Moore, C.G., Porter, M. Rub Chem Technol	<u>31</u>	1090	1958
42.	Dogadkin, B.A., Lloyd, G., Payne, J. Rub Chem Technol	<u>35</u>	1	1962
43.	Dufraisse, C., Houpillart, J. Rub Chem Technol	<u>19</u>	105	1946
44.	Dibbo, A.D., Lloyd, G., Payne, J. Rub Chem Technol	<u>36</u>	911	1963
45.	Gerke, R.H. Rub Chem Technol	<u>36</u>	1153	1963
46.	Mocker, F., Old, I. Kautschute Gummi	5	149	1962
47.	Morita, E., Young, E.J. Rub Chem Technol	<u>36</u>	844	1963
48.	Scheele, W., Stemmer, H.D. Kautschute Gummi	11	WT 325	1958
49.	Campbell, R.H., Wise, R.W. Rub Chem Technol	<u>37</u>	635	1964
50.	Campell, R.H., Wise, R.W. Rub Chem Technol	<u>37</u>	650	1964
51.	Coran, A.Y. Rub Chem Technol	<u>37</u>	3 668	1964
52.	Coran, A.Y. Rub Chem Technol	<u>37</u>	3 673	1964
53.	Coran, A.Y. Rub Chem Technol	<u>37</u>	3 679	1964
54.	Coran, A.Y. Rub Chem Technol	<u>37</u>	3 689	1964
55.	Coran, A.Y. Rub Chem Technol	<u>37</u>	4 1	1964
56.	Russell, R.D., Smith, D.A., Welding, D.N. Rub Chem Technol	<u>36</u>	835	1963
57.	Studebaker, M.L. Phillips Chemical Co Akron			1954

58. Studebaker, M.L., Nabors, L.G.
Kaustchuke Gummi 14 WT 177 1961
59. Redding, R.B., Smith, D.A.
IRI Journal 237 1970
60. Skinner, T.D., Watson, A.A. Rubber Age 76 1967
61. Colclough, T., Cunneen, J.L., Higgins, G.M.C.
J. Appl Pol Science 12 295 1968
62. Morrison, N.J., Porter, M. PRI Journal 104 1982
63. Kempermann, T., Eholzer, U.
Int Rubber Conf Harrogate C4-1 1981
64. Wolff, S. Proc Int Rub Conf 1045 1979
65. Tuttle, J.B., 'The Analysis of Rubber'
The Chemical Catalogue Co. USA 1922
66. ASTM - D279 Chemical Analysis of Rubber Prds 1958
67. BSI - BS903 Standard Methods of Testing Rubber 1950
68. Wake, W.C. 'Analysis of Rubber and Rubber-like
Substances' Maclean and Sons 1958
69. Kress, K.E. Analytical Chem 23 2 1951
70. Gaczynski, R., Stepien, M.
Soviet Rubber Technol 20 1 1961
71. Lloyd, D.G., Hawkes, J.C. Monsanto Progress Rpt 1962
72. Auler, H. Gummi Asbest Kunststoffe 14 1024 1961
73. Higgins, G.M.C., McSweeney, G.P.
Rub' Chem Technol 47 5 1974
74. Lussier, F.E. Rubber World 1983
75. Simpson, D. Additives in Plastics, Petroleum
and Food April 1972
76. Protivova, J., Popisil, J.
J. Chromatography 92 361 1974
77. Nagasawa, K., Ohta, K. Bunseki Kagaku 16 1285 1967
78. Francis, V.C., Sharma, Y.N., Bhardwaj, I.S.
Die Angewandte Makromolekulare 113 219 1983

79. Popl, M., Vit, I., Smejkal, F.
J. Chromatography 213 363 1981
80. Lichtenthaler, R.G., Ranfelt, F.
J. Chromatography 149 553 1978
81. Blenkin, J. Dunlop Research Centre Report cr3107 1980
82. Sullivan, A.B., Kuhls, G.H., Campell, R.H.
Rubber Age No 3 41 1081 1976
83. Manley, T.R. 'Thermal Methods of Analysis'
Applied Science Publishers 1980
84. Hartenstein, G. Caoutchoucs et Plastiques 1982
85. Maurer, J.J. Rubber Age 112 47 1980
86. Maurer, J.J. 'Thermal Analysis'
Acedemic Press New York Vol 1 1969
87. Swarin, S.J., Wims, A.M.
Rub Chem Technol 47 657 1974
88. Pautrat, R., Metivier, B., Martreau, J.
Rev Gen Cautot Plast 52 273 1975
89. Brazier, D.W. Thermochemica Acta 18 147 1977
90. Rugo, G., Barbattini, D., Cappellazzo, G., Poponessi, M.
Proc Int Rubber Conf. 472 1979
91. Pausch, J.B., Lattimer, R.P., Meuzelaar, H.L.C.
American Chemical Society Paper 28 May 1983
92. Smith, A.C. Sample Quarterly July 1983
93. Martin, A.J.P., Synge, R.L.M.
Biochemical Journal 35 1358 1941
94. Martin, A.J.P., James, A.T.
Biochemical Journal 50 679 1952
95. Blenkin, J. Proc Fourth IRI Conf London 575 1962
96. Ney, E.A., Heath, A.B.
Australian Rubber Conference of the IRI Sept 1968
97. Thompson, W.C. Laboratory Practice 18 1074 1969
98. Thompson, W.C. Science and Industry 12 7 1978
99. Thompson, W.C. PRI Journal 3 No 4 1978

100. Thompson, W.C., Coulter, G.L. 'Analytical Pyrolysis'
Elsevier Scientific Publishing Co. 1977
101. Patel, S.M., Hively, R.A., Cole, J.O.
103rd Meeting of Rubber Division ACS. Paper 21 1973
102. Wise, R.W., Sullivan, A.B.
Rubber Age Vol 91 No 5 1962
103. Krishen, A. Analytical Chemistry 55 5 1983
104. Devlin, E.F. J. Pol. Sci. 19 4 1981
105. Mercer, H.N. Proc Int Rubb Conf. Oct 1979
106. Smith, J.D.B., Jerson, D.D., Meier
J. Applied Science 18 543 1974
107. Nah, S.H., Thomas, A.G.
J. Pol Science. 18 511 1980
108. Nix, M.J. European Rubber Journal Jul 1974
109. Sain, M.M. Rubber India 35 2 1983
110. Thompson, W.C. MSc Thesis Jun 1983
111. Smith, F.I., Jones, E.
'A Scheme of qualitative Organic Analysis'
London 1953
112. Dawson, B. Dunlop Research Centre Report CR2376 1964
113. Davies, J.R. N.A.P.R.A. Interim Report 1966
114. Tunnicliffe, M.E.
Dunlop Research Centre Report CR2515 1966
115. Randerath, K. 'Thin Layer Chromatography'
Academic Press 1963
116. Luker, R. Chemical Laboratory Report
St. Mary's Mills Leicester 1964
117. Kreiner, J.G., Warner, W.C.
American Chemical Soc. Paper 4 Ohio 1965
118. Thompson, W.C.
Tyre Chemical Laboratory Report CL 53 1968