



**Some pages of this thesis may have been removed for copyright restrictions.**

If you have discovered material in Aston Research Explorer which is unlawful e.g. breaches copyright, (either yours or that of a third party) or any other law, including but not limited to those relating to patent, trademark, confidentiality, data protection, obscenity, defamation, libel, then please read our [Takedown policy](#) and contact the service immediately ([openaccess@aston.ac.uk](mailto:openaccess@aston.ac.uk))

SETTLEMENT OF FILL WITH PARTICULAR REFERENCE TO  
OPENCAST COAL MINING SITES

DAVID ANDREW PATTERSON

Master of Philosophy

THE UNIVERSITY OF ASTON IN BIRMINGHAM

OCTOBER, 1986

This copy of the thesis has been supplied on condition that anyone who consults it is understood to recognise that its copyright rests with its author and that no quotation from the thesis and no information derived from it may be published without the author's prior, written consent.

Settlement of fill with particular reference to opencast coal mining sites.

David Andrew Patterson

Master of Philosophy

October, 1986

Synopsis

A study of information available on the settlement characteristics of backfill in restored opencast coal mining sites and other similar earthworks projects has been undertaken. In addition, the methods of opencast mining, compaction controls, monitoring and test methods have been reviewed.

To consider and develop the methods of predicting the settlement of fill, three sites in the West Midlands have been examined; at each, the backfill had been placed in a controlled manner. In addition, use has been made of a finite element computer program to compare a simple two-dimensional linear elastic analysis with field observations of surface settlements in the vicinity of buried highwalls.

On controlled backfill sites, settlement predictions have been accurately made, based on a linear relationship between settlement (expressed as a percentage of fill height) against logarithm of time. This 'creep' settlement was found to be effectively complete within 18 months of restoration. A decrease of this percentage settlement was observed with increasing fill thickness; this is believed to be related to the speed with which the backfill is placed.

A rising water table within the backfill is indicated to cause additional gradual settlement.

A prediction method, based on settlement monitoring, has been developed and used to determine the pattern of settlement across highwalls and buried highwalls. The zone of appreciable differential settlement was found to be mainly limited to the highwall area, the magnitude was dictated by the highwall inclination. With a backfill cover of about 15 metres over a buried highwall the magnitude of differential settlement was negligible.

Use has been made of the proposed settlement prediction method and monitoring to control the re-development of restored opencast sites. The specifications, tests and monitoring techniques developed in recent years have been used to aid this. Such techniques have been valuable in restoring land previously derelict due to past underground mining.

OPENCAST MINING  
BACKFILL SETTLEMENT  
COMPACTION

## ACKNOWLEDGEMENTS

I wish to acknowledge the help and encouragement given by both internal and external supervisors, K. Starzewski, B.Sc., Ph.D., C.Eng., M.I.C.E. and C. V. Knipe, B.Sc., C.Eng., M.I.Min.E., M.I.M.M., M.I.Geol., F.G.S.

For allowing me to use the site investigation and settlement results for the cast study sites I thank Johnson Poole and Bloomer, Coal Contractors Ltd. and McLean Homes (Midlands) Ltd. I would especially thank J. Wreghitt of Coal Contractors for his assistance with the testing undertaken at the Hurst site and who subsequently assisted in providing much additional survey information. The assistance of P. Partridge of Ground Investigation and Piling Ltd. in the initial field testing, and the subsequent loan of equipment was also appreciated.

I also thank Fugro Ltd. who so kindly offered to undertake testing at the Hurst site even when it was not possible to use the site for demonstration purposes.

In providing the finite element program I thank D. Just of the Civil Engineering Dept., Aston University and for assisting in the subsequent amendments and running of the program I gratefully thank M. Linskill of the Computer Centre at Aston University.

The encouragement and financial assistance given by Johnson Poole and Bloomer and Geotechnical Engineering (Southern) Ltd. are greatly appreciated, without both, this research would have foundered years ago.

I am very much in debt to my wife Kathy, and my two sons Thomas and Daniel for the tolerance they have shown over the past five years. I am especially grateful to four of my wife's fingers which so ably typed the draft thesis!

My thanks finally to Jill Gibbons who has so expertly produced the final typed thesis.

LIST OF CONTENTS

	<u>Page Number</u>
TITLE PAGE	1
SYNOPSIS	2
ACKNOWLEDGEMENTS	3
LIST OF CONTENTS	4 - 7
LIST OF FIGURES	8 - 14
SECTION 1 <u>INTRODUCTION</u>	15
1.1 Background to Settlement Problem.	16 - 17
1.2 Scope of Research Project.	17 - 18
SECTION 2 <u>REVIEW</u>	19
2.1 Methods of Mining.	20 - 21
2.2 Composition of Backfill Materials.	22
2.3 Weathering of Backfill Materials.	22 - 23
2.4 Observations of Settlement in Restored Opencast Coal Mining Sites.	23 - 28
2.5 Observations of Settlement in Restored Opencast Ironstone Mining Sites.	28 - 31
2.6 Observations of Settlement in Rock/Earth Fill Dams.	31 - 32
2.7 Summary of Long Term Settlement Observations - with particular reference to opencast sites.	32 - 33
2.8 Mechanisms of Settlement.	34 - 35
2.9 Mechanisms of Heave.	35
SECTION 3 <u>CONTROLS</u>	47
3.1 Principles and Specifications.	48 - 50
3.2 Laboratory Compaction Tests.	50 - 54
3.2.1 Introduction.	50 - 52
3.2.2 Principles.	52 - 53
3.2.3 Use.	53 - 54

	<u>Page Number</u>
3.3 In-Situ Density/Moisture Tests.	54 - 59
3.3.1 Introduction.	54
3.3.2 Moisture Content Determination.	54
3.3.3 In-Situ Density Determination.	54 - 55
3.3.4 Portable Nuclear Density/Moisture Gauges.	55 - 59
3.4 Index Properties.	59
3.5 Moisture Condition Value.	60 - 62
3.5.1 Introduction.	60
3.5.2 Principle.	60
3.5.3 Apparatus.	60
3.5.4 Procedure.	60 - 61
3.5.5 Use.	61 - 62
3.6 Visual Observations.	62 - 63
 SECTION 4 <u>MONITORING AND PERFORMANCE</u>	 72
4.1 Introduction.	73
4.2 Engineering Parameters.	73 - 75
4.3 Settlement Monitoring.	75 - 77
4.4 Groundwater Monitoring.	77 - 78
4.5 Performance of Structures.	78
 SECTION 5 <u>CASE STUDY SITES</u>	 80
5.1 Introduction.	81
5.2 Holly Bank Opencast Site, Essington, South Staffordshire.	82 - 96
5.2.1 Introduction.	82
5.2.2 Location and Description.	82
5.2.3 Geology.	83
5.2.4 Past Underground Mining.	83 - 84
5.2.5 Opencast Mining Operations.	84 - 85

	<u>Page Number</u>
5.2.6 Site Compaction and Controls.	85 - 87
5.2.7 Monitoring.	87
5.2.8 Settlement Observations.	87 - 96
5.2.8.1 General.	87 - 88
5.2.8.2 Allowable Settlement.	88
5.2.8.3 Settlement in the Main Backfill Areas.	89 - 90
5.2.8.4 Settlement Close to Highwalls.	91 - 92
5.2.8.5 Settlement Across Buried Highwall.	93
5.2.8.6 Settlement of Uncompacted Fill.	94 - 95
5.2.8.7 Summary of Settlement Observations.	95 - 96
5.3 Hurst Opencast Site, Netherton, West Midlands.	141 - 163
5.3.1 Introduction.	141
5.3.2 Location and Descriptions.	141 - 142
5.3.3 Geology.	143 - 144
5.3.4 Mining History.	144
5.3.5 Opencast Mining Operations.	145 - 147
5.3.6 Site Compaction and Controls.	147 - 150
5.3.7 Monitoring and Testing.	150 - 163
5.3.7.1 Plate Loading Tests.	152 - 155
5.3.7.2 Penetrometer Testing.	155 - 157
5.3.7.3 Settlement Observations.	158 - 161
5.3.7.4 Summary of Monitoring and Testing Information.	162 - 163
5.4 Milking Bank Meadows (Phase IV), Dudley, West Midlands.	241 - 249
5.4.1 Introduction.	241
5.4.2 Location and Description.	241 - 242
5.4.3 Geology.	242 - 243
5.4.4 Past Mining History.	243 - 244

	<u>Page Number</u>
5.4.5 Opencast and Backfilling Operations.	244 - 245
5.4.6 Monitoring and Investigations.	245 - 247
5.4.7 Settlement Observations.	247 - 248
5.4.8 Summary.	248 - 249
SECTION 6 <u>COMPUTER MODELLING</u>	261
6.1 Introduction to Modelling Techniques.	262 - 263
6.2 Finite Element Program.	263 - 265
6.3 Basic Model.	266 - 271
6.3.1 Models C1 to C4.	268 - 270
6.3.2 Models C12 to C15.	270 - 271
6.4 Application to Site Sections and Depth Profiles.	271 - 275
6.4.1 Holly Bank Sections.	272 - 273
6.4.2 Hurst Section.	273 - 275
SECTION 7 <u>CONCLUSIONS AND RECOMMENDATIONS</u>	305
7.1 Introduction.	306
7.2 Settlement Prediction.	306 - 309
7.3 Field Controls and Monitoring.	309
7.3.1 Field Controls on Backfilling.	309 - 310
7.3.2 Monitoring and Testing.	310 - 313
7.3.2.1 Monitoring.	311 - 312
7.3.2.2 Testing.	312 - 313
7.4 Application of Settlement Prediction to Site Development.	313 - 315
7.5 Topics for Further Research.	315 - 316
REFERENCES	317 - 321



## LIST OF FIGURES

<u>Figure Number</u>		<u>Page Number</u>
	<u>Section 2</u>	
2.1.1	Simplified sequence of opencast coal mining.	36
2.1.2	Opencast coal mining operations.	37
2.4.1	Observed settlement of fill.	38
2.4.2	Settlement observations - Chibburn opencast site.	39
2.4.3	Settlement observations - Chibburn opencast site.	40
2.4.4	Surface settlement - Traverse A, Horsley.	41
2.4.5	Vertical compression measured with a rising water table at Horsley.	42
2.4.6	Location of opencast mining sites - Dudley and Stourbridge.	43
2.4.7	Settlement v. fill thickness for various sites.	44
2.5.1	Settlement observations at Snatchill, Corby.	45
2.6.1	Comparison between observed and predicted movements - Scammonden Dam.	46
	<u>Section 3</u>	
3.1.1	Table 6/2 - compaction requirements.	64
3.2.1	Dry density - moisture content relationship for soils.	65
3.2.2	Dry density - moisture curves for various compactive efforts.	66
3.3.1	Nuclear density gauge - direct transmission mode.	67
3.3.2	Nuclear density gauge - backscatter mode.	68
3.5.1	Moisture condition apparatus.	69
3.5.2	The determination of the moisture condition value of heavy clay.	70
3.5.3	Relation between undrained shear strength and MCV for clays of intermediate and high plasticity.	71
	<u>Section 4</u>	
4.3.1	Magnet extensometer borehole settlement gauge.	79

Section 5

5.2.1	Site location plan - Essington.	97
5.2.2	General geological succession.	98
5.2.3	General geology and extent of opencast area.	99
5.2.4	Geological section.	100
5.2.5	Contours on floor of opencast excavation.	101
5.2.6	Plan showing backfill areas.	102
5.2.7	General details of backfill areas.	103
5.2.8 and 5.2.9	Summary of settlement results.	104 - 105
5.2.10	Settlement v. time - Areas 2 - 4	106
5.2.11	Settlement v. time - Area 6	107
5.2.12	Settlement v. time - Area 7	108
5.2.13 to 5.2.15	Settlement v. time - Area 8/9	109 - 111
5.2.16	Settlement v. time - buried highwall - Area 8/9	112
5.2.17	Estimated thickness of fill at settlement stations.	113
5.2.18	Summary of settlement results - fill thickness 10-20 metres	114
5.2.19	Summary of settlement results - fill thickness 20-30 metres	115
5.2.20	Summary of settlement results - fill thickness 30-40 metres	116
5.2.21	Summary of settlement results - fill thickness 40-50 metres	117
5.2.22	Summary of settlement results - fill thickness 50-60 metres	118
5.2.23	Mean settlement results for full range of fill thicknesses.	119
5.2.24	Settlement (expressed as percentage of fill height) against logarithm of time - for range of compacted backfill thicknesses and uncompacted fill.	120
5.2.25	Plan showing settlement survey stations.	121
5.2.26	Settlement v. time - Section E4.	122
5.2.27	Settlement v. time - Section E5.	123

<u>Figure Number</u>		<u>Page Number</u>
5.2.28	Settlement v. time - Section E6.	124
5.2.29	Section E4 - settlement and excavation profiles.	125
5.2.30	Section E5 - settlement and excavation profiles.	126
5.2.31	Section E6 - settlement and excavation profiles.	127
5.2.32	Lateral displacements - Sections E4, 5 and 6.	128
5.2.33	Settlement v. time - Section E1.	129
5.2.34	Settlement v. time - Section E2.	130
5.2.35	Section E1 - settlement and excavation profiles.	131
5.2.36	Section E2 - settlement and excavation profiles.	132
5.2.37	Section E7 - settlement and excavation profiles.	133
5.2.38	Lateral displacements - Section E1.	134
5.2.39	Lateral displacements - Section E2.	135
5.2.40	Settlement v. time - uncompacted area.	136
5.2.41	Settlement v. time - Section E3.	137
5.2.42	Section E3 - settlement and excavation profiles.	138
5.2.43 and 5.2.44	Lateral displacements - Section E3	139 - 140
5.3.1	General location plan - Hurst.	164
5.3.2	Geological succession.	165
5.3.3	General geology.	166
5.3.4	General geological section.	167
5.3.5	Location of abandoned mineshafts and adits.	168
5.3.6	Total excavation area.	169
5.3.7	Long section south-north through opencast area indicating progressive development.	170
5.3.8	Typical section east-west across opencast excavation.	171
5.3.9	Main backfill benches.	172
5.3.10	General details of backfill areas.	173
5.3.11	Soil compaction data - proctor compaction tests.	174

<u>Figure Number</u>		<u>Page Number</u>
5.3.12	Soil compaction data - nuclear gauge tests.	175
5.3.13	Soil compaction data - sand replacement tests.	176
5.3.14	Soil compaction data - nuclear gauge tests on coaly samples.	177
5.3.15	Location of test and monitoring positions.	178
5.3.16 to 5.3.25	Plate loading test - consolidation curves.	179 - 188
5.3.26 to 5.3.33	Plate loading test - load settlement curves.	189 - 196
5.3.34	Young's modulus against increase in pressure.	197
5.3.35 to 5.3.40	Borehole logs.	198 - 203
5.3.41	Plot of N values against depth.	204
5.3.42	Cross section of Fugro friction cone.	205
5.3.43 to 5.3.48	Static cone penetrometer logs.	206 - 211
5.3.49	Guide for estimating soil type.	212
5.3.50	Correlation between static cone and standard penetration tests.	213
5.3.51 to 5.3.53	Settlement v. time - southern area.	214 - 216
5.3.54	Settlement v. time - central area.	217
5.3.55	Settlement (expressed as percentage of fill height) against logarithm of time - for all settlement stations.	218
5.3.56	Settlement against logarithm of time - fill thickness 0-10 metres.	219
5.3.57	Settlement against logarithm of time - fill thickness 10-20 metres.	220
5.3.58	Settlement against logarithm of time - fill thickness 20-30 metres.	221
5.3.59	Settlement against logarithm of time - fill thickness 30-40 metres.	222
5.3.60	Settlement against logarithm of time - mean values for fill thickness range.	223
5.3.61	Section H1 - settlement and excavation profiles.	224
5.3.62	Section H2 - settlement and excavation profiles.	225
5.3.63	Section H3 - settlement and excavation profiles.	226

<u>Figure Number</u>		<u>Page Number</u>
5.3.64	Section H4 - settlement and excavation profiles.	227
5.3.65	Section H5 - settlement and excavation profiles.	228
5.3.66	Settlement v. time - southern area - magnet extensometer E1.	229
5.3.67	Settlement v. time - central area - magnet extensometer E2.	230
5.3.68	Settlement v. time - extensometer E1	231
5.3.69	Settlement v. time - extensometer E2.	232
5.3.70	Vertical compression - extensometer E1.	233
5.3.71	Mean settlement plots (settlement zero at month 1) Essington.	234
Plate 5.3.1	'Crown holes' close to south-east corner of site. October 1983.	235
" 5.3.2	Adit entrance. November 1983.	235
" 5.3.3	Finished backfill area. March 1986.	236
" 5.3.4	Void space left at northern end of site. March 1986.	236
" 5.3.5	Ripping the formation. April 1983.	237
" 5.3.6	Excavation of thick coal pickings.	237
" 5.3.7	Looking north over opencast area - excavation of Heathen coals in middle ground, Thick coal remnants exposed beyond. October 1984.	238
" 5.3.8	Looking east over final excavation area - Heathen coals and Thick coal pickings exposed.	238
" 5.3.9	Open gallery in Thick coal - south end of western highwall. September 1983.	239
" 5.3.10	Open gallery in Thick coal - north end of western highwall. March 1985.	239
" 5.3.11	Looking north over opencast area - backfill bench in foreground. July 1984.	240
" 5.3.12	Plate loading test. August 1985.	240

<u>Figure Number</u>		<u>Page Number</u>
5.4.1	Site location plan - Milking Bank Meadows.	250
5.4.2	General geology and location of phase IV - Milking Bank Meadows.	251
5.4.3	Generalised stratigraphical succession.	252
5.4.4	Location of surface settlement stations.	253
5.4.5	Plot of SPT N value against depth.	254
5.4.6 and 5.4.7	Summary of settlement results.	255 - 256
5.4.8 to 5.4.10	Settlement v. time.	257 - 259
5.4.11	Settlement (expressed as a percentage of fill height) against logarithm of time.	260
<u>Section 6</u>		
6.3.1	General outline of basic finite element model.	276
6.3.2	Young's modulus v. depth of fill.	277
6.3.3	Basic finite element model C1.	278
6.3.4	Basic finite element model C2.	279
6.3.5	Basic finite element model C3.	280
6.3.6	Basic finite element model C4.	281
6.3.7	Basic finite element model C12.	282
6.3.8	Basic finite element model C13.	283
6.3.9	Basic finite element model C14.	284
6.3.10	Basic finite element model C15.	285
6.4.1	Model E1 - including surface settlement and stations for comparative real profile.	286
6.4.2	Model E3 - including surface settlement and stations for comparative real profile.	287
6.4.3	Model E7 - including surface settlement and stations for comparative real profile.	288
6.4.4	Model H1 - with settlement profiles for H1, H26 and as predicted by settlement monitoring.	289
6.4.5	Finite element model H1 - data variation sets H11 - H14.	290

Figure Number

Page Number

6.4.6	Finite element model H1 - data variation sets H15 - H18.	291
6.4.7	Finite element model H1 - data variation sets H19 - H22.	292
6.4.8	Finite element model H1 - data variation sets H23 - H26.	293
6.4.9	Young's modulus values for H1 variations.	294
6.4.10	Build up of model H1 (H100).	295
6.4.11	Build up of model H1 (H101).	296
6.4.12	Build up of model H1 (H102).	297
6.4.13	Build up of model H1 (H103).	298
6.4.14	Build up of model H1 (H104).	299
6.4.15	Build up of model H1 (H105).	300
6.4.16	Build up of model H1 (H106).	301
6.4.17	Build up of model H1 (H107).	302
6.4.18	Build up of model H1 (H108).	303
6.4.19	Build up model H1 - plot of cumulative settlement with depth.	304

APPENDICES

APPENDIX I	Plate Loading Test Data - Hurst Opencast Site.	322 - 357
APPENDIX II	Finite Element Program.	354 - 373

1. INTRODUCTION

1.1 Background to Settlement Problem.

1.2 Scope of Research Project.



## 1.1 BACKGROUND TO SETTLEMENT PROBLEM

Currently coal is being extracted by opencast working in Great Britain at an annual rate of over 10 million tonnes. The extraction of 1 tonne of coal may typically involve the removal of 15 to 20 cubic metres of overburden, also the depth of excavation required to accomplish this coal extraction is commonly about 30 metres but at Butterwell in Northumberland, coal will be excavated from 135 metres and at the Westfield site in Scotland it is intended to work ultimately to depths of 220 metres.

As a consequence of the growth of opencasting operations since the last World War extensive areas are left which have in most cases been backfilled with loosely placed overburden materials of variable depth, and can undergo significant settlement. Since these sites were frequently intended for agricultural use on completion of restoration the amount and variability of settlement which occurred in the backfill was of little consequence. However, in recent years, with the shortage of building land (principally in industrial areas), sites of this type are being considered more and more for development purposes. Building on sites of this type may involve several geotechnical problems, but the major one is likely to be associated with long-term settlement of the fill.

During the past 15-20 years various researches have looked into the settlement characteristics of backfill in opencast coal mining sites as well as other situations where overburden materials have been used for filling, such as in opencast ironstone workings, earth and rock fill embankment dams and highway embankments. In association with this, work has been carried out in determining the mechanisms for settlement, the

methods by which settlements or displacement can be recorded, the geotechnical properties of overburden materials, weathering effects on Coal measures rocks and controls on the placement of fills.

## 1.2 SCOPE OF RESEARCH PROJECT

A review of the information currently available on the settlement of backfill materials and restored opencast mining sites was undertaken as part of this project and is contained in Section 2. This has not only involved settlement data but a review of methods of backfill control (Section 3) which can, or have, been applied, methods of testing and techniques available for monitoring of settlement (Section 4).

Three case studies, all of which involve restored opencast coal mining sites, have been examined in detail in Section 5. These are sites where the backfilling was usually undertaken in a controlled manner and hence the results can be expected to be relatively uniform and reproducible. The history, development, controls and monitoring undertaken at each have been examined and comparisons made between each. Particular attention was given to the differential settlement which occurs adjacent to highwalls due to varying thicknesses of backfill.

At the Hurst site additional testing was carried out as part of this research; this included a series of plate loading tests at various levels in the backfill, and static cone penetrometer probes which were carried out by Fugro Ltd. The former were used to examine the deformation characteristics of fill and the latter for comparison with conventional Standard Penetration Tests.

The results of settlement monitoring were used to develop of

what appears to be an accurate method of settlement prediction. This method has been used to examine settlement profiles across the boundaries of the restored sites. Further studies of the behaviour of the backfill, in the vicinity of buried highwalls, were undertaken using finite element techniques (Section 6). These results were used for comparison with observed settlements.

Conclusions and recommendations derived from the above studies are detailed in Section 7.

## 2. REVIEW

- 2.1 Methods of Mining.
- 2.2 Composition of Backfill Materials.
- 2.3 Weathering of Backfill Materials.
- 2.4 Observations of Settlement in Restored Opencast Coal Mining Sites.
- 2.5 Observations of Settlement in Restored Opencast Ironstone Mining Sites.
- 2.6 Observations of Settlement in Rock/Earth Fill Dams.
- 2.7 Summary of Long-term Settlement Observations - with Particular Reference to Opencast Sites.
- 2.8 Mechanism of Settlement.
- 2.9 Mechanism of Heave.

## 2.1 METHODS OF MINING

Currently (Hughes, 1986) opencast coal production in England, Wales and Scotland is around 14 million tonnes per annum. The extraction of 1 tonne of coal may typically involve the removal of 20 cubic metres of overburden.

With the exception of perhaps small random opencast excavations the most common method of opencast coal mining is as shown in the simplified sequence of operations for single seam workings depicted in Figure 2.1.1.

Topsoil and subsoil are removed by tractor scraper and placed in storage mounds on the site perimeter. Excavation to the coal seam in the initial cut is usually by face shovel and the spoil is transported by dump truck to the overburden mound for storage. Successive cuts are then excavated by dragline and/or face shovel with spoil going into the previous cuts. The final void is backfilled using the spoil from the overburden mound (i.e. from the initial cut) and subsoil and topsoil are replaced. Normally, agricultural restoration is carried out which would include grading, stone picking, tree planting and fencing. Figure 2.1.1 shows that there is usually a net volume increase in the backfill materials (bulkage) and this is accommodated in the final restoration contours.

Figure 2.1.2 shows a plan and section of a typical multi-seam operation and illustrates some of the terminology used to describe the main features of an opencast mine. The geology greatly influences the way in which a site is operated, for example, where the strata are only very gently dipping, the cuts may be aligned parallel to the strike, but in more steeply

dipping strata, cuts parallel to the dip direction are usually adopted to prevent the sliding of either loosewall or highwall into the working void.

In some situations the bedding dips are so steep that excavation plant and other vehicles cannot operate on the steep bedding surfaces. In these circumstances the Open Pit Method is adopted, which involves progressively lowering the floor of the pit and working the steep seams as the pit descends. This method necessitates storing a larger quantity of overburden spoil in mounds above ground level than in the more usual strike cut or dip cut methods. Replacement of the backfill is again progressive, the area being worked in a series of "panels", i.e. very wide cuts (Hughes, 1986).

Different backfilling procedures have been adopted to the above, especially where the intention has been to restore the land for industrial or housing development. As reported by Knipe (1979) the methods adopted have included:

- (i) Using motor box scrapers to pick up the material from overburden mounds and deposit it in broad layers, usually between 150 and 250mm in uncompacted thickness. The fill spread in these layers is compacted merely by the constant (and variable) criss-cross passage of laden scrapers weighing up to 60 tonnes.
- (ii) Using motor box scrapers to place the overburden in controlled layers then applying adequate compaction effort in general accordance with Series 600 of The Specification for Road and Bridgeworks (D. of T., 1976). Typically, several passes of heavy towed vibrating rollers achieves the necessary compactive effort.

## 2.2 COMPOSITION OF BACKFILL MATERIALS

Excavation to uncover coal seams in opencast mining sites in Britain are generally within the Middle (sometimes Upper) Coal Measures of the Carboniferous Period. The composition of the backfill materials, therefore, normally reflects the nature and composition of these strata. In addition, any superficial deposits which may have been formerly found overlying the bedrock will tend to be mixed in with the rock fill.

The dominant Coal Measures strata consist of argillaceous rocks such as mudstone, shales, siltstones and seatearths; arenaceous rocks such as sandstones are frequently a minor component of these strata. The proportion of argillaceous beds usually exceeds the arenaceous strata by more than three to one and frequently the proportion is much greater (Leigh and Rainbow, 1979). The superficial drift deposits (where present) usually consist of cohesive boulder clay-type materials.

As a result, within most backfilled opencast mining sites (including those within the South Staffordshire Coalfield area), the backfill consists predominantly of mudstone and silty mudstone fragments in a clay matrix with a smaller proportion of sandstone, siltstone, carbonaceous shales, sideritic clay-ironstone, and coal fragments (Knipe, 1979).

## 2.3 WEATHERING OF BACKFILL MATERIALS

As outlined by Taylor (1979), it is reasonable to suppose that argillaceous rocks excavated at depth must once more attain equilibrium in what may be an entirely new physio-chemical environment. Contact with water, either in a washery or in a spoil heap, helps to promote physical disintegration, which will be aggravated by transportation, tipping and spreading

activities. Sedimentary structures (e.g. bedding and joint planes) help promote breakdown under conditions of desiccation and slaking. These phenomena tend to reduce the weaker rocks to gravel and sand sizes within months or even weeks of excavation.

Mineralogical investigation of a spoil heap at Yorkshire Main Colliery by Spears et al. (1971) found that the spoil, once deeply buried in the tip, changed very little although shales and mudstones with high contents of expanding, mixed layer clay may break down more completely into component grains over a period of time. More intense weathering is normally restricted to the top 1 to 3 metres. Chemical weathering does not play any major role in the breakdown of rocks of this type.

It is reasonable to suppose that the weathering effects on fill in a restored opencast site would be similar to those in a spoil heap. The higher degree of handling during excavation, stockpile re-excavation and compaction will, however, cause further mechanical breakdown and mixing of materials. In addition, opencast mining is often carried out in areas which have been partially mined in the past by underground mining. As a consequence, the strata can be expected to be somewhat fractured and mildly weathered even before opencasting.

## 2.4 OBSERVATIONS OF SETTLEMENT IN RESTORED OPENCAST

### COAL MINING SITES

Since 1943 the Ministry of Fuel and Power then (since 1958) the National Coal Board Opencast Executive has been responsible for the development of opencast coal mining. In this role they were often called upon to offer advice on the stability of restored sites even though these sites were not reinstated with building



development in mind and accordingly no special compaction requirements were imposed during restoration.

In the early years it was generally recommended that settlement could be regarded as negligible after some years, generally less than five years. This was, however, not based on any detailed settlement studies. It was not until 1950 that detailed observations on a number of relatively shallow sites were undertaken.

Meyerhof (1951) was one of the earliest researchers to produce settlement - time relationships for fills of different materials, including rockfill (Figure 2.4.1). He concluded that the larger proportion of movement usually occurred during the first two years after construction of the fill and even within that period proceeds at a rapidly reducing rate, and that settlements beyond five years were generally small.

In 1965, with the advent of sites being worked to greater depths and the increasing demand for development land, the Department of Civil Engineering, University of Newcastle-upon-Tyne, undertook on behalf of the NCB Opencast Executive a study of the stability of restored opencast sites in North-East England.

The study (Kilkenny, 1968) considered the bearing capacity and compressibility characteristics of opencast backfills, principally at Chilburn Opencast Site in Northumberland. The intention being to establish a means of predicting the rate of settlement and to develop a method for determining the bearing capacity of the fills for residential and industrial development.

From observations at Chilburn and sites where buildings had been founded in opencast fills, it was suggested that the bearing

pressures imposed by the proposed structures should be limited to 75 kN/m<sup>2</sup>. In addition, building could commence almost immediately where the fill thickness does not exceed about 9 metres, after 6 years for fill thicknesses between 9 and 30 metres and after a minimum of 12 years for greater thicknesses. For the deeper fills the magnitude of total settlement, and differential settlement between backfill and adjacent undisturbed ground and between worked areas remained the major consideration to earlier release of restored sites.

Kilkenny postulated that a semi-logarithmic plot of average settlement versus time resulted in a linear relationship (Figures 2.4.2 and 2.4.3) as had already been observed in rockfill dams (Sowers et al, 1965). It was believed that this settlement-time relationship could be applied to opencast fill of any depth, constructed in the same way, but this had not been verified.

Settlement monitoring continued at Chilburn and other restored sites in accordance with the recommendations given by Kilkenny in 1968. Problems were encountered in evaluating the results (Leigh and Rainbow, 1979); any relationship between the magnitude of settlement and fill depth were masked by factors such as the type of restoration, the backfill constituents, re-establishment of ground water levels and the elapsed time between backfilling and the commencement of levelling. The maximum settlement observed corresponded to 1.6 percent of fill thickness, although in the majority of cases cited the settlement was less than 1 percent.

A further recommendation put forward by Kilkenny was to study the relationship between the settlement of fill and the re-establishment of the water table. Such a study was carried

out by the Building Research Station in collaboration with the NCB Opencast Executive (Charles et al, 1977 and Charles, 1984) at Horsley in Northumberland. At Horsley it was necessary to pump water from a sump to allow the site to be opencast mined. This pumping was continued until after backfilling was completed. When pumping stopped ground movement caused by saturation of the backfill was monitored at the surface and at various depths in the fill using a series of magnet extensometers.

The principal conclusions from the investigation at Horsley were as follows:

- (a) Some differences in settlement characteristics of the cohesionless backfill could be related to features of the opencast mining operation such as the position of a lagoon and an overburden heap. Where the backfill had been pre-loaded by an overburden heap during the opencast operation, heave of the ground was recorded on its removal and there was a considerable reduction in the settlement experienced on saturation. Differential settlements were seen to be most marked at the edges of the backfill area, Figure 2.4.4.
- (b) With the backfill unaffected by changes in the level of the water table, small creep movements due to self-weight can still occur some time after the completion of backfilling.
- (c) Saturation by a rising water table can cause some vertical compression in a loose unsaturated cohesionless backfill left by opencast mining. Locally, vertical compressions caused by inundation were as large as 2 percent, Figure 2.4.5. Settlements of the ground surface of up to 0.7 metres were measured.

It is evident from this study that in at least loosely placed backfilled opencast sites not only should the time since completion of restoration be considered but also the time since the re-establishment of the water table.

The other major factor to be investigated was how varying degrees of compaction during backfilling could influence the observed settlement. Knipe (1979) investigated this aspect, by observing settlements on a number of sites in the West Midlands, Figure 2.4.6. Three broad categories were identified based on the magnitude of settlement and the method of fill placement:

- (i) Sites restored by motorised box scrapers operating over broad areas at a time and those where the material is spread in layers and compacted with vibrating rollers. Here the maximum settlements were generally less than 0.5 percent of the fill thickness.
- (ii) With relatively uncompacted sites, where a combination of tracked dozers and motorised box scrapers were used for backfilling, the settlement was about 1 percent of the fill thickness.
- (iii) Uncompacted (i.e. end tipped) opencast mining fill which can ultimately settle by several percent of their thickness.

The contrast between the rates and magnitude of settlement resulting from differing methods of placing fill are presented on Figure 2.4.7. Vertical settlements when plotted against the logarithm of elapsed time (up to six years) were almost always remarkably linear.

A problem recognised at many of the sites referred to above is that of differential settlement close to the edges of the opencast areas. Kilkenny (1968) indicated that although

variations in settlement do occur within the main body of the fill they are not usually sufficient to cause structural damage, however, structural damage could arise where a building is located on the edge of the opencast area. Similar observations have been made by Charles et al (1977) and Gilbert et al (1979) where variations were exhibited in the settlement of fill due to the positions of lagoons and overburden mounds, but the most significant variation was along the edge of the highwalls.

In view of the above it has been common policy to ensure that no buildings are constructed where they may straddle the boundary of an opencast area or lie close to the edge of the fill area. This has been applied to development shortly after restoration and also many years afterwards.

The width of the 'sterilisation' zone is normally calculated on the bases of half the fill depth (at the base of the highwall) or 20 metres, whichever is greatest. Following restoration, where settlement monitoring results are available, the width can be calculated on the basis of what total settlement is expected across the edge area and a limiting differential settlement. In addition, the zone width is usually extended by between 5 and 10 metres outside the recorded opencast area to accommodate any inaccuracies in the surveying of the highwall.

## 2.5 OBSERVATIONS OF SETTLEMENT IN RESTORED OPENCAST IRONSTONE MINING SITES

In the Corby area, the Northampton Ironstones have been opencast mined to depths of between 15 and 30 metres. The ironstones are overlain by weak oolitic limestones and boulder clay in layers

of about equal thickness. This overburden is stripped by large walking draglines and left as it is dumped from their buckets. The irregular piles are later levelled by bulldozer and covered with topsoil for agricultural use.

Due to expansion of the new town some of this land was required for housing and industrial developments. In order to investigate the problems of development on restored land of this type, research has been carried out by the Building Research Station in co-operation with the Corby Development Corporation. In the light of information already available at the time, from restored opencast coal mining sites, research concentrated on foundation solutions to accommodate settlement of the fill and methods of improving the materials engineering performance. In 1963, twenty-four experimental houses were built on a restored site with four different types of foundation design. The performance of these houses was monitored and the results reported by Penman and Godwin (1975).

The following settlement observations were made:

- (a) Creep settlement due to the fills own weight was still taking place twelve years after backfilling but the amount was only small.
- (b) Maximum rates of settlement occurred immediately after construction and decreased to small rates after four years. These movements were believed to be mainly attributable to the compression of the fill under the weight of the houses.
- (c) When drainage stopped and the water table was allowed to rise the settlement rate increased.

From this study it was suggested that similar sites could be pre-settled prior to construction by inundation in order to

minimise post construction settlements.

Charles et al (1978) investigated the usefulness of a number of different forms of ground treatment in improving the load carrying characteristics of loose fill left by opencast ironstone mining. Each of three 50m x 50m square areas were subjected to different forms of ground treatment (dynamic consolidation, inundation and pre-loading) and subsequently two-storey dwellings of standard design, with cavity walls on trench fill foundations, were built on the three treated areas and on a fourth of untreated ground.

All three treatment methods had some success in compacting this cohesive fill, Figure 2.5.1. Inundation appeared to be the least successful of the treatment methods used. This was probably due to the difficulty of saturating fill by the addition of water from the ground surface.

Laboratory tests indicated that susceptibility to collapse settlement is linked to the percentage of air voids in the cohesive fill. As the average compression of the fill produced by both dynamic consolidation and pre-loading with surcharge was greater than the maximum compression measured in the inundation area, it was suggested that these methods had reduced the potential for collapse settlement in the upper layer of the fill.

Of the three treatment methods used, only surcharge loading led to a demonstrably better performance of houses built on the treated ground when compared with the houses built on untreated ground.

The most significant characteristics from the standpoint of building development on the site was the susceptibility to collapse settlement on inundation and the creep compression in

the fill due to self weight under conditions of constant stress and moisture content.

## 2.6 OBSERVATIONS OF SETTLEMENT IN ROCK/EARTH FILL DAMS

Sowers et al (1965) summarised the available dam settlement information available at that time and carried out a number of tests examining the consolidation of the materials used in rock dam construction. Their results showed that a narrow range of settlement occurred, from about 0.25 to 1.0 percent of the height in a ten year period following completion. They suggested that the amount of settlement appeared to be related to the height of the dam and method of construction - loosely dumped, compacted or sluiced. A linear relationship between percentage of settlement and time on a logarithmic scale was proposed.

Following the development of new methods to record the settlements which occur in dams Westenberger (1967) presented the results of detailed monitoring at the Steinbach and Eggberg dams (U.S.A.). Both dams were earth-fill dams constructed in thin layers, each of which was mechanically compacted. It was concluded that the rate and amount of settlement which could be expected was primarily dependent upon the nature of the fill material, the degree of compaction and the dam height.

Further researchers looked into aspects such as the quality and suitability of fill, observations and predictions of settlement, methods of measuring displacements, laboratory analysis of the compression and general geotechnical properties of the fills and weathering characteristics in subsequent years.

Useful papers included Kennard et al (1967), who looked at the



geotechnical properties and behaviours of carboniferous shale at the Balderhead Dam, Penman et al (1971 and 1973) who predicted and observed deformations in embankment dams (Figure 2.6.1), and Penman and Charles (1975) who looked into the quality and suitability of rockfill used in dam construction. The information, hypotheses and analytical methods determined by these and other researches in this field have been considered, and in some cases adopted, when looking at the behaviour of opencast back-fill materials, methods of compaction, forms of monitoring and laboratory analysis since they are, to some extent, comparable.

2.7 SUMMARY OF LONG-TERM SETTLEMENT OBSERVATIONS - WITH PARTICULAR REFERENCE TO OPENCAST SITES

Settlement of opencast spoil materials has been attributed to a number of causes, principally, the self weight of the fill, structural loads and inundation by water in a loose fill. A useful distinction can be made between, firstly, 'creep' movements occurring at constant stress and moisture content; secondly, compression due to applied loads; and thirdly, 'collapse' settlement due to increasing moisture content in a loosely placed, unsaturated fill.

CREEP SETTLEMENT - In many situations, self weight will be the principal cause of long-term settlement of the fill. With granular fills (and poorly compacted unsaturated fills of all types) primary compression occurs immediately a load is applied and consequently the major part of compression due to self-weight occurs as the fill is placed. Nevertheless significant further movements occur under conditions of constant

stress and moisture content and can be termed 'creep' settlement (Charles and Burland, 1982).

It has been found that creep settlement shows a linear relationship when plotted against the logarithm of the time that has elapsed since the backfilling was completed. Observations have indicated that the percentage vertical compression that does or could occur over a period of time depends upon the depth of the fill as well as its composition and degree of compactness. A change in stress or moisture content would lead to much greater movements.

COMPRESSION DUE TO AN INCREASE IN STRESS - additional compression will occur in opencast spoil under the loads applied to it by buildings, structures or spoil mounds. The amount varies depending on the nature of the fill, its grading, moisture content and compactness, the existing stress level and the magnitude of the stress increment (Charles and Burland, 1982). As with settlement due to self-weight, much of the compression will occur at the time of application of the loading.

COMPRESSION DUE TO INCREASED MOISTURE CONTENT - usually, loose, unsaturated fill materials are liable to collapse compression on inundation, although this can occur in more compact fills but to a lesser extent. If such inundation occurs after building development on the fill, a serious settlement problem may arise. At Horsley (Charles et al, 1977) the effect of a rising groundwater table on 70 metres of uncompacted fill was to cause local collapse compression, as large as 1.5 percent of the fill thickness.

## 2.8 MECHANISM OF SETTLEMENT

The concensus of opinion is that the most probable mechanism of settlement in a loose granular fill is the crushing of highly stressed points of contact between particles and the subsequent progressive re-orientation of particles into more stable positions until equilibrium is attained (Sowers et al, 1965. Kilkenny, 1968). The effect of saturation either by re-establishment of the water table or from external sources (such as sluicing) is to cause softening of the mineral bonds and thereby accelerate the crushing at the points of contact.

Penman (1971), in reviewing the compression characteristics of rockfill, stated that in order to minimise the settlement of rockfill caused by loading and wetting, the intergranular forces should be minimised and the particles prevented from moving into a denser packing. This could be averted by grading the sizes of the particles and efficient compaction so that there is a minimum of void from the outset and hence a maximum of inter-particle contacts.

This approach, combined with the increasing size and power of earth-moving and compaction machinery, plus the economic advantage of being able to use an all-in material, has led to the use of compacted rockfill for major dam embankment as opposed to loosely dumped, sound, coarse rockfill. A similar approach has been adopted in dealing with the backfilling of a number of the more recent opencast sites intended for industrial and housing development and hence where it is desirable to minimise both total and differential settlements. In the more usual circumstances of backfill which is a mixture of cohesive clay matrix and rock fragments the scale of particle sizes will

range from boulder sized fragments through sand sized grains to clay platelets.

## 2.9 MECHANISM OF HEAVE

This phenomenon has been observed and reported by a number of researchers (Charles et al, 1977 and Knipe, 1979). Knipe (1979) suggested that long term heave is principally caused by the removal of overburden mounds on parts of backfilled sites and is due to a combination of several mechanisms, such as:

- (i) Elastic rebound after the removal of the surcharge load of overburden mounds;
- (ii) Elastic expansion of rock fragments under the reduced effective load as the fill becomes inundated; and
- (iii) Swelling of the clay matrix caused by the steady uptake of percolating rainwater.

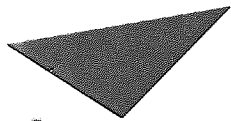

Aston University

**Content has been removed for copyright reasons**

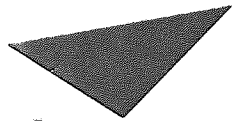

Aston University

**Content has been removed for copyright reasons**

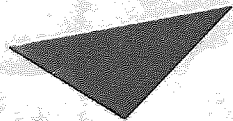

Aston University

**Content has been removed for copyright reasons**

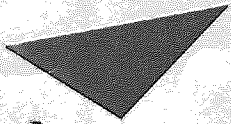

Aston University

**Content has been removed for copyright reasons**



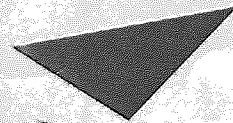

Aston University

**Content has been removed for copyright reasons**

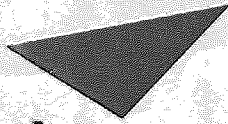

Aston University

**Content has been removed for copyright reasons**

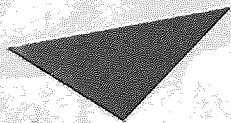

Aston University

**Content has been removed for copyright reasons**

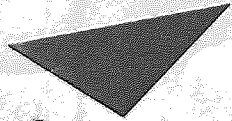

Aston University

**Content has been removed for copyright reasons**

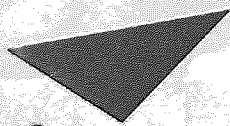

Aston University

**Content has been removed for copyright reasons**

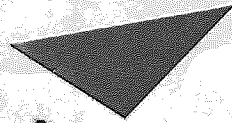

Aston University

**Content has been removed for copyright reasons**

### 3.1 PRINCIPLES AND SPECIFICATIONS

An appropriate

specification

is required

to be used

## 3. CONTROL OF COMPACTION

3.1 Principles and Specifications.

3.2 Laboratory Compaction Tests.

3.3 In-Situ Density/Moisture Tests.

3.4 Index Properties.

3.5 Moisture Condition Value.

3.6 Visual Observations.

### 3.1 PRINCIPLES AND SPECIFICATIONS

An essential requirement in the proper infilling of an opencast site (or any other earthworks contract) is the close control of the quality of the earthworks. This typically involves controlling the types of materials used, fill layer thicknesses, placement moisture content, the type and number of passes of compaction plant and ensuring that adequate control testing is carried out during the field operations.

The types of control used will depend upon the type of specification adopted for the contract. A detailed specification is usually required to ensure that both the Contractor and the Engineer are agreed on the quality of the operation. Not only should a specification clearly define the standard to be met, or method adopted, for the compaction of the fill but any engineering criteria to be met. For example, in the backfilling of an opencast site, regard will have to be given to such aspects as slope stability, keying of backfill areas to the highwall and between each other, the preparation of the formation and records required for the site.

Three types of specification are generally used, the relative compaction specification, the air voids specification and the method specification.

The relative compaction specification was used on many of the early large scale earthworks contracts and although it has been superseded, it is often still quoted. The principal of this specification is that the soil being compacted should achieve a dry density equal to 90 or 95



percent of the maximum dry density determined in one of the British Standard (BS1377, 1975) tests. Difficulties with this specification largely resulted from the laboratory tests only being able to test materials passing the B.S. 19mm sieve and also that the laboratory compactive effort may bear little resemblance to field compactive effort (Road Research Laboratory, 1952). This is further complicated by the delays and expense involved in carrying out the numerous field and laboratory tests required.

The air voids specification was introduced in the 'Specification for Road and Bridgework' (M. of T., 1963) to overcome the problems presented by the above specification as a result of grading variations. This detailed that for fill within 0.6 metres of the formation level, a maximum of 10 percent air voids was permitted, this maximum was allowed to be exceeded in one test out of ten. With this specification the upper limit of moisture content has to be carefully observed otherwise the specification could be achieved with little compactive effort at high moisture content.

The 'Specification for Road and Bridgeworks' produced in 1976 (D. of T., 1976) introduced a method specification which basically divides soils into three categories and details, for each, the layer thicknesses and number of passes for each category of compaction plant (Figure 3.1.1). If the Contractor should wish to utilise an item of plant not listed, then he must undertake a field compaction trial to the Engineer's satisfaction. In this specification the amount of quality control testing is kept to a minimum and more responsibility is placed upon the Engineer to ensure that the quality of the

compacted fill is sufficient.

Currently, the method specification is most frequently employed when opencast fill is going to be replaced in a controlled manner. However, there is still a tendency to have a relatively high degree of testing carried out during the compaction phase, these are usually the new, speedy and relatively cheap tests. Inevitably, however, the more conventional field and laboratory tests are still relied on for comparative purposes.

The control of compaction during the course of the site operations can be carried out using:

- (i) Laboratory compaction tests,
- (ii) In-situ density/moisture tests,
- (iii) Index properties tests,

and by (iv) Visual observations.

The principles involved, procedures and uses of the above controls are discussed in the following sections.

## 3.2 LABORATORY COMPACTION TESTS

### 3.2.1 Introduction

Soil compaction is a process whereby the soil particles are mechanically constrained to pack closely together through a reduction in the air voids. In the field, compaction of the soil is usually effected by mechanical means such as rolling, ramming or vibrating. Laboratory compaction tests have been developed to assimilate these field conditions in order that they may provide the basis

for contract procedures used on site.

There are several different standard laboratory compaction tests available. The test selected for use as a basis for comparison will depend upon the nature of the work, the type of soil and the compaction equipment used on site.

In Britain there are two standard compaction tests for cohesive soils, both employing a metal rammer dropped on soil contained in a mould. The British Standard 'light' compaction test is essentially the same as that devised by Proctor which consists of compacting soil in a 100mm diameter x 117mm high mould with a metal rammer weighing 2.5kg which is dropped through a height of 300mm. The soil is compacted in three equal layers, each layer being given 27 blows uniformly distributed. The British Standard 'heavy' compaction test (or modified AASHO) utilises a heavier rammer of 4.5kg and is dropped through a height of 460mm. In this case the soil is compacted in five equal layers, totalling 125mm, each layer receiving 27 blows.

Falling hammer tests are used on cohesive soils to knead the air pockets out due to the relative difficulty of removing occluded air pockets from soils with very low permeabilities. For granular soils, vibrating hammer compaction is more efficient as demonstrated by practical experience with vibrating rollers in the field. In the vibrating hammer laboratory test the soil is compacted in three equal layers totalling 125mm in a 150mm diameter

C.B.R. mould. The vibrating hammer is of a specified 750 watt capacity and is loaded, manually, with a specified load.

### 3.2.2 Principles

The laboratory compaction tests basically examine the relationship between dry density and moisture content for a given degree of compactive effort.

In these tests the soil is compacted at varying moisture contents applying the same compactive effort for each stage. If at each stage the compacted dry density is calculated, and plotted against moisture content, a graph similar to curve A in Figure 3.2.1 is obtained. The moisture content at which the greatest value of dry density is reached for a given amount of compaction is the optimum moisture content, and the corresponding dry density is the maximum dry density. At this moisture content the soil can be compacted most efficiently under the given compactive effort. The relationship between bulk (wet) density and moisture content is shown by the dotted curve (W) in Figure 3.2.1.

A typical compaction curve obtained from the British Standard 'light' compaction test is shown on Figure 3.2.2 as curve A. If a heavier degree of compaction, corresponding to a Standard 'heavy' compaction test is applied at each moisture content, higher values of density and therefore dry density will be obtained. The resulting moisture - density relationship will be a graph such as curve B in Figure 3.2.2. The maximum

dry density is greater, but the optimum moisture content at which it occurs is lower than in the 'light' test.

Every different degree of compaction on a particular soil results in a different compaction curve, each with a unique value of optimum moisture content and maximum dry density. For instance a compaction test similar to the British Standard 'light' test but using 60 blows per layer instead of 27 would give a graph similar to that shown by curve C in Figure 3.2.2. A test similar to the Standard 'heavy' compaction test but using a greater number of blows would give a graph similar to curve D. It can be demonstrated that increasing the compactive effort increases the maximum dry density, but decreases the optimum moisture content (Head, 1980).

### 3.2.3 Use

Since the different tests will yield different compaction curves for the same soil it is only to be expected that different items of compaction plant will also yield different compaction curves.

Therefore there need not necessarily be any direct relationship between the compaction curves of the laboratory tests and the curves of compaction plant. The original Proctor compaction test was developed when compaction plant was much lighter than today. The heavier compaction test was introduced as a result of the increasing size of compaction plant. Although the heavier test may be more representative

of the performance of heavier earthmoving compaction plant it may not necessarily be identical.

### 3.3 IN-SITU DENSITY/MOISTURE TESTS

#### 3.3.1 Introduction

The most commonly employed method of checking the performance of compacted fill is by in-situ density and moisture determinations. This would particularly apply where the performance specifications, referred to in Section 3.1 are being used. The principal methods employed, both by conventional physical tests and indirect nuclear tests are described below.

#### 3.3.2 Moisture Content Determination

This is normally carried out by taking a disturbed sample from the site and testing it in accordance with BS1377, 1975 Test 1(A). This is the standard oven drying method whereby moisture content is expressed as a percentage of the soil's dry weight. Although the period required for drying the sample varies, it is normal, however, to allow 36 hours from delivery of samples to a laboratory before the results are available by this method.

#### 3.3.3 In-situ Density Determination

The general methods which can be used in any type of soil is the sand replacement method, BS1377, 1975 Tests 14 A, B and C. This method involves the excavation of a cylindrical hole of about 100mm in diameter to the depth of the layer being tested. The

soil removed is weighed and its water content determined while the volume of the hole is measured by replacing the soil with a known amount of a uniformly graded sand.

The fieldwork time involved in this test is obviously greater than that required for a moisture content determination, however, the time taken from commencement to production of results is primarily dictated by the time taken to determine the moisture content.

#### 3.3.4 Portable Nuclear Density/Moisture Gauges

The portable nuclear density/moisture gauge is a device which can provide an instantaneous digital read-out of both the required parameters on-site during the course of the compaction works. Since this is an 'indirect' test, calibration is required with the conventional physical tests described above. General principals and methods of testing are detailed below.

3.3.4.1 Density Determination - for this determination, a small sealed cesium 137 radioactive source emits gamma radiation into the test material. If the material is low in density a large amount of gamma radiation will pass through and so be detected by the geiger/mueller detector also situated within the gauge. A material of low density will therefore give a high meter reading for a unit period of time. A material of high density will give a low meter reading for the same

unit period of time, as the high density material absorbs the gamma radiation and in effect acts as a radioactive shield.

In the testing of compacted materials the density determinations would normally be carried out by the direct transmission method whereby the gamma source is placed in the test material by means of a punched access hole. The source is located at the lower end of a probe which on most models can be lowered to a depth of 300mm in increments of 25 or 50mm. The material tested is that in the path of the photons between the source and detector (Figure 3.3.1).

The test can also be carried out with the gamma source in the retracted position, this is referred to as the backscatter mode. The material tested in this mode is from directly beneath the gauge to a depth of between 50 and 65mm (Figure 3.3.2).

3.3.4.2 Moisture Determinations - In this case a small sealed americium 241 : beryllium radioactive source mounted in the base of the device emits neutron radiation into the test material. The high energy neutrons are moderated (thermalised) by collision with hydrogen atoms in moisture contained in the test material. Therefore only low energy, moderated neutrons are detected by the helium 3 detector. If the test material is wet the meter will indicate a high response, if it is dry the meter will indicate a low response for the same unit period of time.



Unlike the cesium 137 source, the source for moisture determination cannot be moved, therefore the material tested is that directly beneath the gauge, similar to the backscatter mode.

With all of the currently available nuclear gauges, operating in the moisture mode, it is the hydrogen (and to a far lesser degree other elements) which is measured. Since the usual major component in soil containing hydrogen is water, then the counts registered by the detector tube reflects the moisture content in the soil.

The moisture content of a soil can normally be accurately measured in this way, providing there are no other constituents present in the soil to interfere with the operation. There are however a number of interference conditions which can be identified and fit into two main categories:

A. Where the soil contains bound water, molecular hydrogen, water of hydration, adsorbed water or hydrocarbons. For the control of compaction works it is necessary to determine the free water content (that which can be driven off by low temperature oven drying) other types of non-free hydrogen can interfere with the result producing a falsely elevated value.

Examples of hydrogenous materials which can be found are:

(i) Gypsum - for every molecule of calcium sulphate there are two molecules of attached water.

- (ii) Lime - contains a hydroxyl.
- (iii) Mica - usually contain considerable molecular hydrogen.
- (iv) Clay - almost any clay, especially those of the montmorillonite and illite class, contain adsorbed water which is not normally removed by oven drying and sometimes other types of hydrogen are also included in combination.
- (v) Organics - contain hydrocarbons.
- (vi) Hydrocarbons - themselves such as coal and bitumen.

B. The other type of interference comes from soils which contain elements or compounds which will capture or absorb slow neutrons before they can get to the detector tube and be counted. In this case the gauge will read a lower moisture content than is actually present in the form of free water.

Examples of these kinds of material being:

- (i) Rare mineral types containing cadmium, lithium or boron.
- (ii) High salt content.
- (iii) High iron oxide content - must be above 35 to 40 percent to be an effective absorber.

In view of the above it is important to compare the moisture contents determined with the gauge against samples taken to a laboratory and oven-dried, particularly at the start of a project. If there is a consistent error due to the basic composition of

the test material then a correction factor can be applied. Should there be occasional values which seem to be widely different to other nearby results or a visual examination, then this may be resolved by further laboratory tests or it may be discounted if, say, a patch of coal or wood is seen in the test area.

### 3.4 INDEX PROPERTIES

Until recently the most common method of assessing the quality of fill in controlled backfilling operations using cohesive fills was to compare moisture content with the plastic limit. Plastic limit being determined in accordance with BS1377, 1975 Test 3.

For example, in the Specification for Road and Bridge Works (D. of T., 1976) suitable cohesive soils should have a moisture content not less than the plastic limit minus 4. Unsuitable materials include clays with a liquid limit exceeding 90 percent and/or a plasticity index exceeding 65 percent.

Parson (1981) indicates that such tests appear to be based on the apparent ease of testing rather than any ability to measure the engineering properties of the soil. The results of such tests have been shown to lack almost completely any correlation with an engineering property such as undrained shear strength (Arrowsmith, 1979).

### 3.5 MOISTURE CONDITION VALUE

#### 3.5.1 Introduction

A recent development by the Transport and Road Research Laboratory is the Moisture Condition Test, which is intended as a rapid and practical test for use during controlled filling operations.

#### 3.5.2 Principle

The test determines the compactive effort necessary in terms of the number of blows of a rammer, to compact fully a sample of soil. Relations between density and moisture content produced by different compactive efforts tend to converge as the moisture content increases.

#### 3.5.3 Apparatus

The apparatus developed for the test (Figure 3.5.1) has been designed so that the penetration of a rammer into a mould can be measured, thereby avoiding the determination of density. It has a 100mm diameter mould with a free falling rammer having a mass of 7kg and a diameter of 97mm. The height through which the rammer can be dropped is adjustable but is normally maintained at 250mm. The soil samples normally used weigh 1.5kg and are finer than 20mm.

#### 3.5.4 Procedure

To determine the Moisture Condition Value of a sample of soil the penetration of the rammer into the mould is measured at various stages in the compaction of

the soil (Figure 3.5.2). The penetration of the rammer at any given number of blows is compared with the penetration at four times as many blows and the difference in penetration determined. This change in penetration figure is plotted against the lower number of blows in each case (Figure 3.5.2) the number of blows being on a logarithm scale.

The Moisture Condition Value (MCV) is defined as 10 times the logarithm (to the base 10) of the number of blows corresponding to a change in penetration of 5mm on the plotted curve. A change in penetration of 5mm has been arbitrarily selected as indicating the point beyond which no significant change in density occurs (Parsons, 1981).

#### 3.5.5 Use

The MCV can be calibrated with moisture content by determining the MCV at various moisture contents. Using soil tests to determine the relevant parameters required in the design of the earthworks, e.g. undrained shear strength, compressibility etc. an upper limit of moisture content can be related to the limit of acceptable soil condition. This limit of moisture content can be related to MCV through the calibration described above. A typical relation between undrained shear strength and MCV is shown in Figure 3.5.3.

Experience has shown (Parsons, 1981) that a constant MCV can be used as a criterion for suitability, for a given design standard, for the normal variation in

soil types encountered at any one site.

### 3.6 VISUAL OBSERVATIONS

Whatever laboratory or field testing is carried out, an essential ingredient in controlling the backfilling of an opencast site is full and adequate supervision by the Engineer.

Checks would be required on most sites to ensure that:

- (a) The correct number of passes of the specified compaction plant is being carried out, and at the correct speed.
- (b) No excessive rutting occurs due to the fill material being too wet or through poor weather conditions.
- (c) Large stone fragments are removed or placed at such a depth that they will not interfere with the compaction works or any subsequent foundation excavations.
- (d) No unsuitable fill material is used in any controlled backfill area.
- (e) That the benches are keyed into the highwall and adjacent benches.
- (f) The testing is carried out in representative areas.
- (g) Any mineshafts, adits or mineworkings encountered during the excavation phase are either removed or stabilised, prior to which they may represent a stability risk for both men and machines.
- (h) The highwalls and bench slopes do not become unstable.
- (i) The site is surveyed in detail during the course of the operations so that the extent of the opencast area (including its depth and shape) and the stages of backfilling are known. It is often useful to include a

photographic record to compare with the surveys and record any detailed features such as mine entries, mineshafts, water seepages, etc.

- (j) The geology and hydrogeology do not vary significantly from that determined during any preliminary investigations. If they do, then all necessary variations to the scheme need to be designed and implemented.

The above list is not intended to be exhaustive, merely an indication of the sort of checks which may be necessary on such sites. Each site has to be considered as individual and a comprehensive check list considered accordingly.

An advantage of the 'rapid' forms of tests detailed previously, is that not only are they quick but they are usually carried out by the Engineer himself. As a result, the Engineer can check any areas he may feel are suspect, carry out all necessary checks, and instruct the Contractor as necessary.

**Table 6/2 Compaction Requirements**

D = Maximum depth of compacted layer (mm)  
N = Minimum number of passes

Type of compaction plant	Category	Cohesive soils		Well graded granular and dry cohesive soils		Uniformly graded material	
		D	N	D	N	D	N
	Mass per metre width of roll:						
Smooth-wheeled roller	over 2100 kg up to 2700 kg	125	8	125	10	125	10*
	over 2700 kg up to 5400 kg	125	6	125	8	125	8*
	over 5400 kg	150	4	150	8	unsuitable	
Grid roller	over 2700 kg up to 5400 kg	150	10	unsuitable		150	10
	over 5400 kg up to 8000 kg	150	8	125	12	unsuitable	
	over 8000 kg	150	4	150	12	unsuitable	
Tamping roller	over 4000 kg	225	4	150	12	250	4
Pneumatic-tyred roller	Mass per wheel						
	over 1000 kg up to 1500 kg	125	8	unsuitable		150	10*
	over 1500 kg up to 2000 kg	150	5	unsuitable		unsuitable	
	over 2000 kg up to 2500 kg	175	4	125	12	unsuitable	
	over 2500 kg up to 4000 kg	225	4	125	10	unsuitable	
	over 4000 kg up to 6000 kg	300	4	125	10	unsuitable	
	over 6000 kg up to 8000 kg	350	4	150	8	unsuitable	
	over 8000 kg up to 12000 kg	400	4	150	8	unsuitable	
	over 12000 kg	450	4	175	6	unsuitable	
Vibrating roller	Mass per metre width of a vibrating roll						
	over 270 kg up to 450 kg	unsuitable		75	16	150	16
	over 450 kg up to 700 kg	unsuitable		75	12	150	12
	over 700 kg up to 1300 kg	100	12	125	12	150	8
	over 1300 kg up to 1800 kg	125	8	150	8	200	10*
	over 1800 kg up to 2300 kg	150	4	150	4	225	12*
	over 2300 kg up to 2900 kg	175	4	175	4	250	10*
	over 2900 kg up to 3600 kg	200	4	200	4	275	8*
	over 3600 kg up to 4300 kg	225	4	225	4	300	8*
	over 4300 kg up to 5000 kg	250	4	250	4	300	6*
	over 5000 kg	275	4	275	4	300	4*
Vibrating-plate compactor	Mass per unit area of base plate:						
	over 880 kg up to 1100 kg	unsuitable		unsuitable		75	6
	over 1100 kg up to 1200 kg	unsuitable		75	10	100	6
	over 1200 kg up to 1400 kg	unsuitable		75	6	150	6
	over 1400 kg up to 1800 kg	100	6	125	6	150	4
	over 1800 kg up to 2100 kg	150	6	150	5	200	4
	over 2100 kg	200	6	200	5	250	4
Vibro-tamper	Mass:						
	over 50 kg up to 65 kg	100	3	100	3	150	3
	over 65 kg up to 75 kg	125	3	125	3	200	3
	over 75 kg	200	3	150	3	225	3
Power rammer	Mass:						
	100 kg up to 500 kg	150	4	150	6	unsuitable	
	over 500 kg	275	8	275	12	unsuitable	
Dropping-weight compactor	Mass of rammer over 500 kg						
	Height of drop:						
	over 1 m up to 2 m	600	4	600	8	450	8
	over 2 m	600	2	600	4	unsuitable	

**TABLE 6/2 - COMPACTION REQUIREMENTS**

(Specification for Road and Bridge Works, 1976)

**FIGURE 3-1.1.**



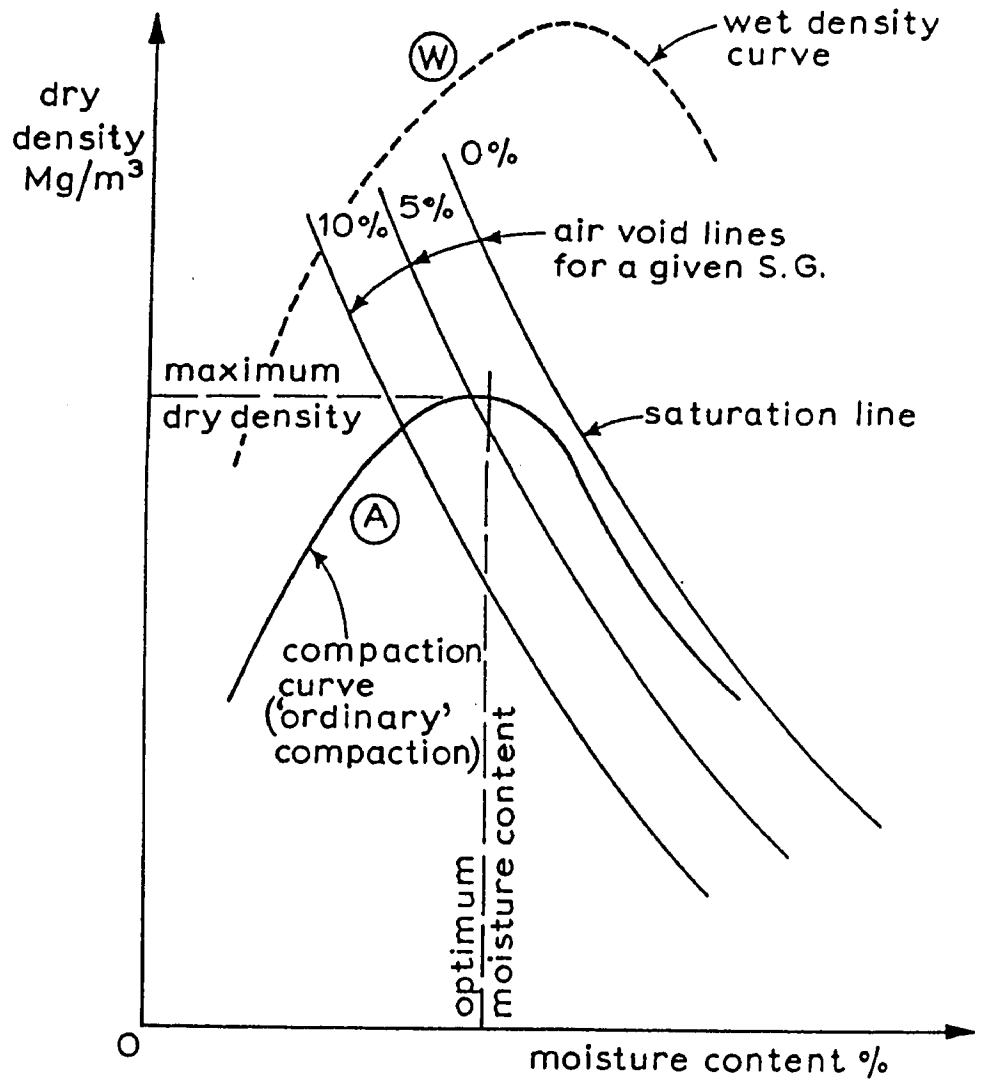

DRY DENSITY-MOISTURE CONTENT RELATIONSHIP FOR SOILS (after Head, 1980).

FIGURE 3-2-1

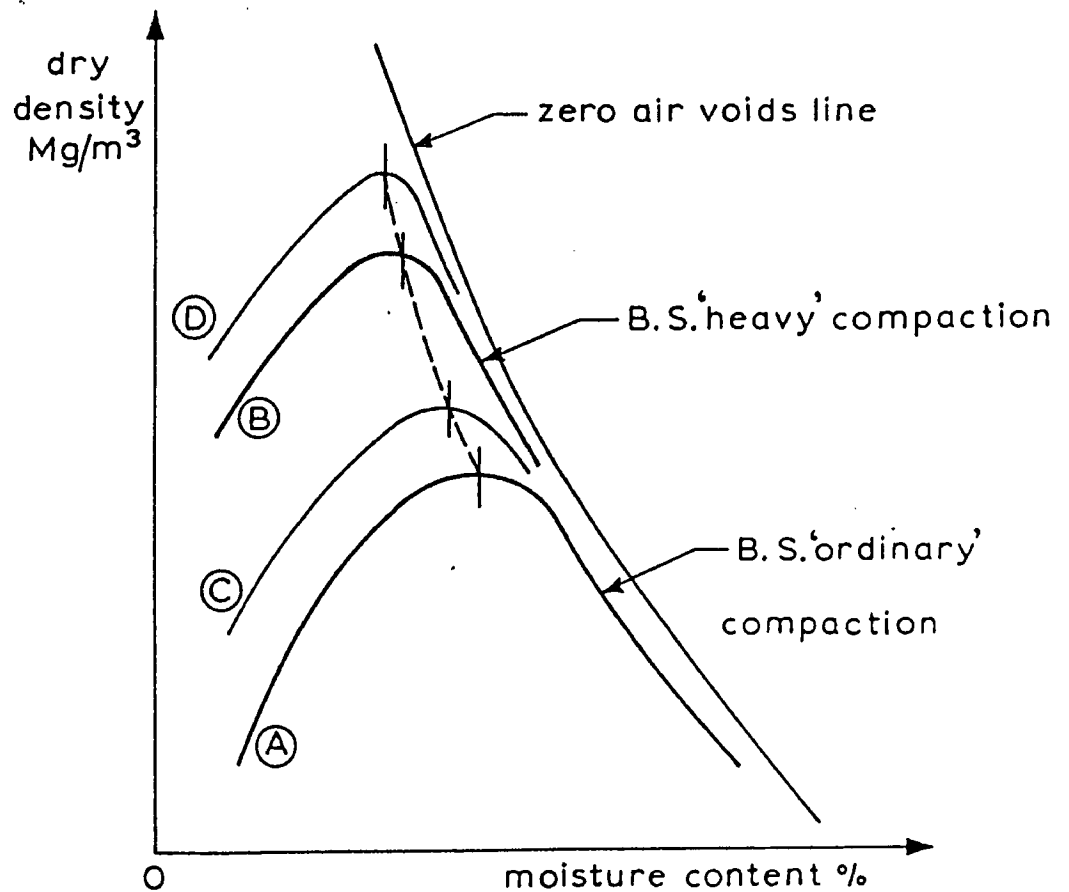

DRY DENSITY-MOISTURE CURVES FOR VARIOUS  
COMPACTIVE EFFORTS (after Head, 1980).

FIGURE 3.2.2

# DIRECT TRANSMISSION

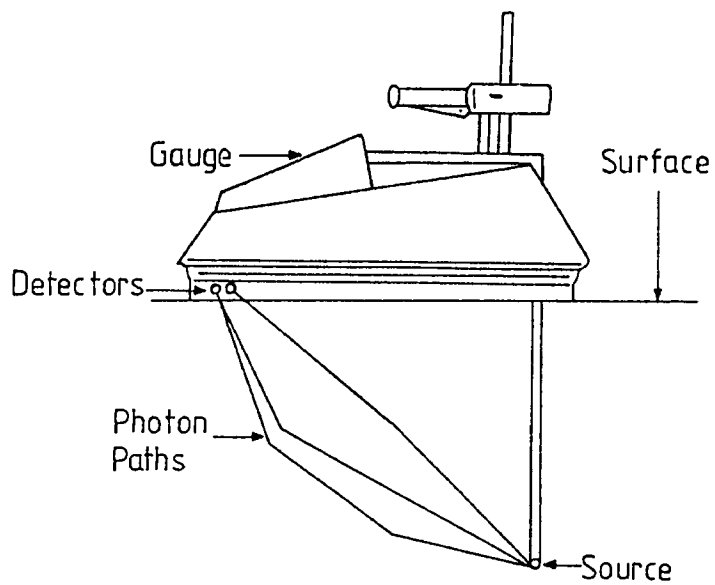

NUCLEAR DENSITY GAUGE-DIRECT TRANSMISSION MODE.

FIGURE 3-3-1.



# BACKSCATTER

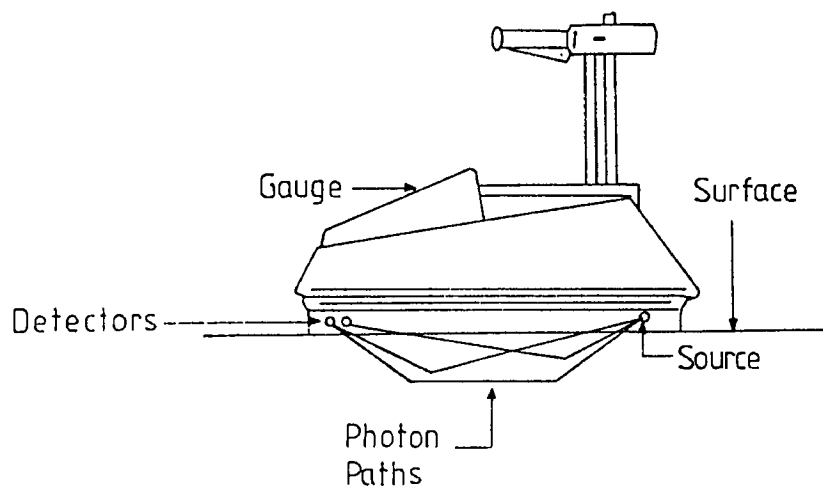

NUCLEAR DENSITY GAUGE - BACKSCATTER MODE.

FIGURE 3-3-2.

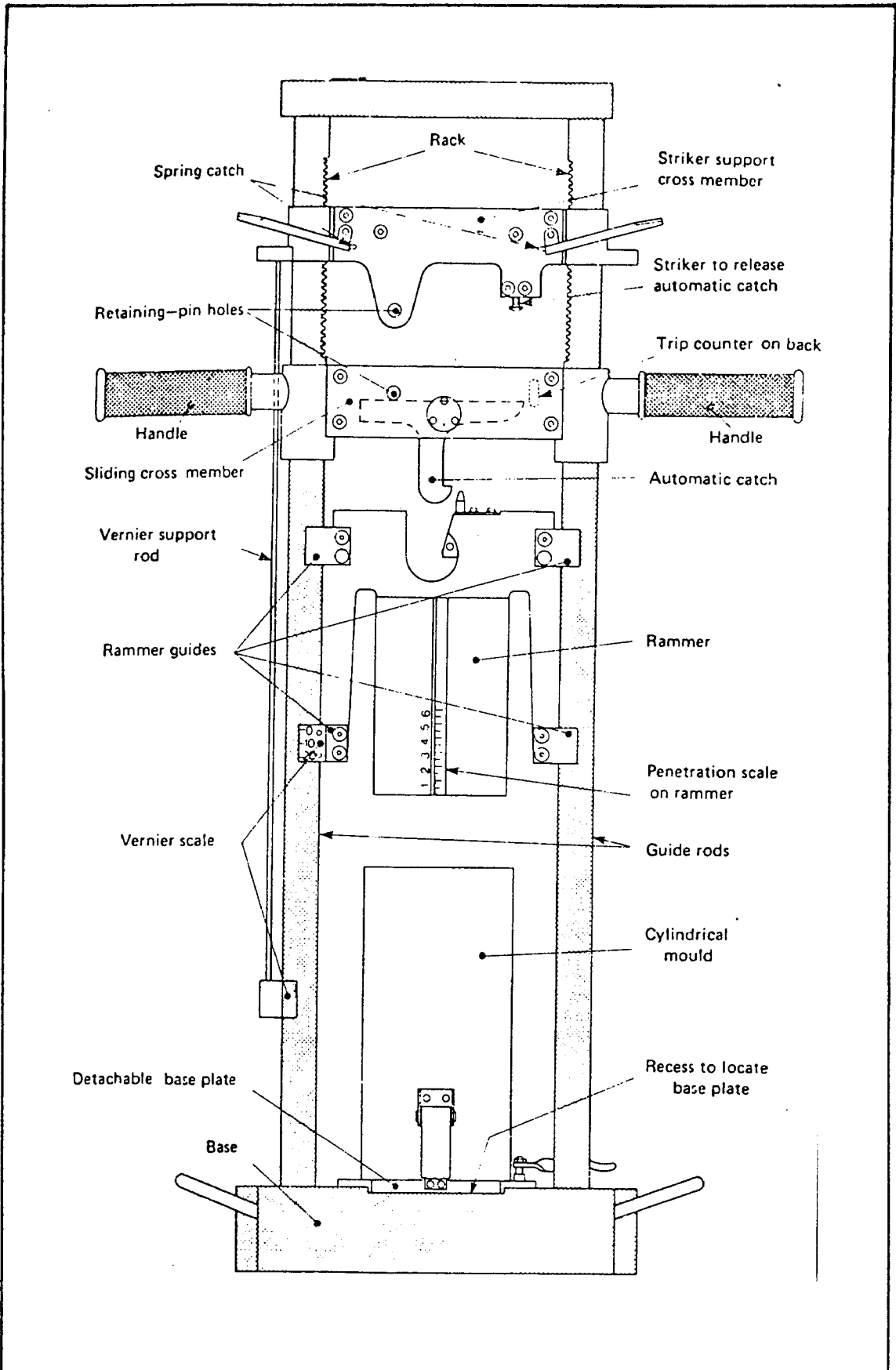

MOISTURE CONDITION APPARATUS.

(after Parsons, 1976).

FIGURE 3-5-1.

Soil: Heavy clay Moisture content: 26.3 per cent

Number of blows of rammer 'n'	Penetration of rammer into mould (mm)	Change in penetration between 'n' and '4n' blows of rammer (mm)
1	41	33.5
2	57.5	33
3	67	33.5
4	74.5	26.5
6	84	17
8	90.5	10.5
12	100.5	0.5
16	101	
24	101	
32	101	
48	101	

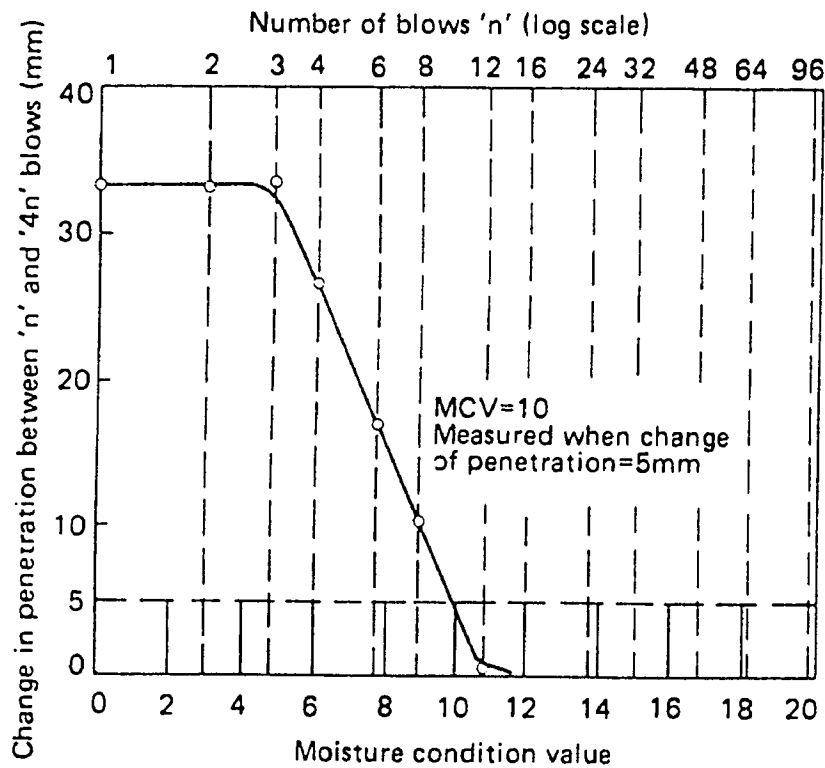

THE DETERMINATION OF THE MOISTURE CONDITION VALUE OF HEAVY CLAY.

FIGURE 3.5.2.

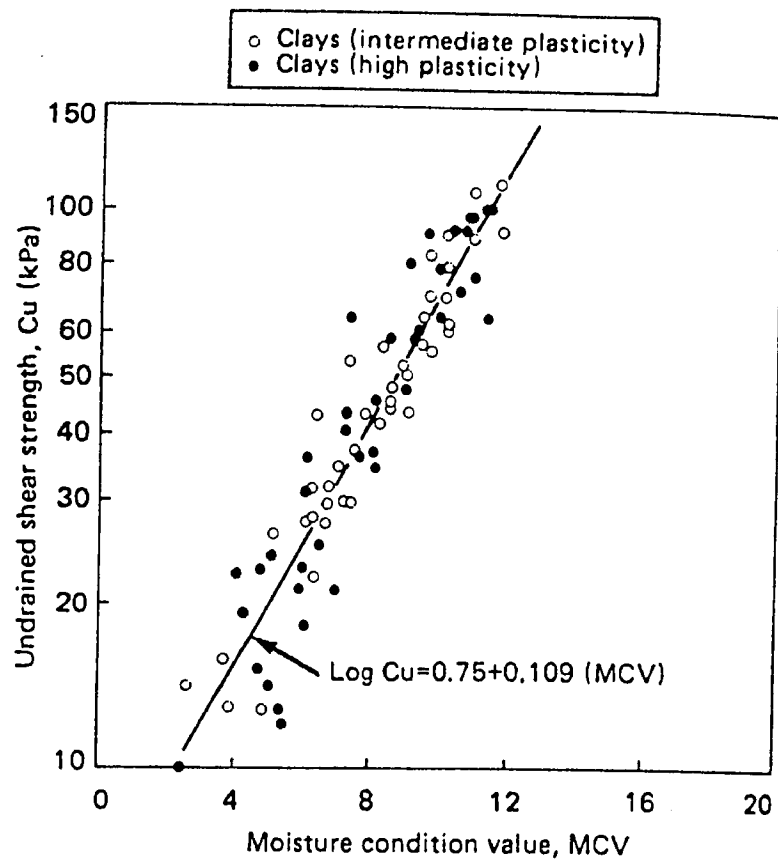

RELATION BETWEEN UNDRAINED SHEAR STRENGTH  
AND M.C.V. FOR CLAYS OF INTERMEDIATE AND  
HIGH PLASTICITY.

FIGURE 3.5.3.

#### 4. MONITORING AND PERFORMANCE

- 4.1 Introduction.
- 4.2 Engineering Parameters.
- 4.3 Settlement Monitoring.
- 4.4 Groundwater Monitoring.
- 4.5 Performance of Structures.



#### 4.1 INTRODUCTION

Although the controls adopted during the course of backfilling work are established on the basis of design criteria, it is often necessary to carry out checks on the performance of the backfill. This checking is often outside the scope of the compaction specification and although some can be carried out during the course of the backfilling operations, it is more normally carried out on completion, or a matter of years after completion. Often this work may follow a change in land ownership, a change in the intended land use, in order to satisfy controlling authorities, or where records of the backfilling are insufficient.

Parameters which may need to be established/checked are, typically, engineering parameters related to the intended development. In addition it will be necessary to establish the date when development may proceed, based on a limiting settlement criteria. Information concerning re-establishment of the groundwater table may also be necessary, particularly where the degree of compaction has not been high. On experimental sites the structures themselves may also be monitored in order to verify whether correct parameters have been adopted.

The main parameters and forms of monitoring which are likely to be required, and methods by which they may be determined, are described in the following sections.

#### 4.2 ENGINEERING PARAMETERS

The engineering parameters normally required are those for

foundation and pavement design, including index properties, shear strength/density, CBR (California Bearing Ratio) values, pH and sulphate content. These are determined using procedures and methods detailed in BS 5930 : 1981 'Code of Practice for Site Investigations' and BS 1377 : 1975 'Methods of Testing Soils for Civil Engineering Purposes.'

The principal consideration is, however, the variation of strength/density of the backfill with depth to assess the standard of backfilling. Often these results are compared with other, similar, sites whose performance is better known. Where it would be normal practice to derive a maximum net allowable bearing pressure from these results, at backfill sites a limiting allowable bearing pressure of  $75 \text{ kN/m}^2$  is commonly adopted following the recommendations of Kilkenny (1968). Higher theoretical bearing pressures may be calculated, but not adopted, due to lack of confidence in the quality of the fills either by the designers or checking authorities.

In order to assess the strength/density of the backfill with depth, a number of techniques and tests are available. Since the backfill is commonly a mixed clay and stone material a combination of tests are usually employed, some of the principal tests are briefly described below.

1. In conventional cable percussive or dry core drilled boreholes a combination of Standard Penetration testing (Test 19, BS 1377, 1975) and undisturbed sampling is commonly adopted.

Although the shear strength can be determined by testing the undisturbed samples (where they can be successfully obtained) it is often of more use to assess the strength of the material from the S.P.T. 'N' values and determine the

bulk and dry densities of the undisturbed samples for comparison with compaction tests and measurements made during the course of backfilling.

2. Static Cone Penetrometer testing has recently been employed on a few restored opencast sites. With this testing a continuous soil profile is produced, measurements being made of cone end resistance and local side friction.

Although an assessment can be made of the basic composition and relative density of the backfill, the correlation of these results with S.P.T. 'N' value and consolidation performance is tentative due to a lack of data.

3. Plate Loading Tests can be carried out in boreholes, or more conventionally, from the surface. Details of procedures and methods of analysis of such tests are detailed in Section 29 of BS 5930, 1981.

Because of the high range of particle sizes likely to be present in the fill the size of plate used in loading tests may have an important influence on the reliability of the results. This was demonstrated in load testing carried out in Leicestershire (Charles, 1984), where the results of loading 0.9m.sq. and 2.0m.sq. pads varied greatly on the same fill.

Results derived from plate loading tests can be used for comparative purposes, determining allowable bearing pressures and as a direct measurement of stiffness of the fill.

#### 4.3 SETTLEMENT MONITORING

Where development is likely to proceed within a number of years following restoration settlement monitoring will be required to

establish the rate of settlement and a date when development may proceed, based on a limiting settlement criterion. Where development is desired at the soonest opportunity it is important to establish a monitoring system as rapidly as possible.

Different settlement monitoring systems are available, the choice will depend on whether settlement is being monitored at the surface or at various depths in the fill.

(a) Surface Settlement Stations - in some instances elaborate levelling stations have been installed where the bottom of the levelling rod is anchored at the base of a borehole and enclosed in an outer sleeve capped at the surface.

Experiments carried out by Knipe (1979) have shown that somewhat more basic stations behave in a very similar manner and because of the reduced cost a greater number can be employed.

The levelling rods subsequently adopted on a number of the sites consist of 1.2m long mild steel rods of about 20mm diameter hammered into the ground, leaving 100mm protruding.

A square grid of 30m to 50m is commonly adopted in main backfill areas, with closer spaced lines of pins placed at right-angles to the highwalls where greater differential settlements are expected.

(b) Magnet Extensometer Systems - these systems have been developed for monitoring settlements at depth in the backfill (of opencast sites and dams).

Magnetic targets are located at various levels down a vertical access tube through which a reed switch is lowered. When the probe enters the magnetic field produced

by a target, an audible signal is emitted at ground level. Measurements made on a steel tape can then be related to a surface levelling station. Targets within the fill mass are allowed to move independent of the access tube, whereas a ring magnet installed below the base of the opencast excavation is attached to the tubing. This in turn, is grouted into the ground, thereby providing a datum in each borehole to which the movement of the magnets in the fill can be related (Figure 4.3.1).

Because of the high cost of these extensometers, only a few (if any) are normally installed, preference being given to deep fill or problem areas, such as adjacent to the highwall.

- (c) Hydraulic and Pneumatic Settlement Cells - remote settlement cells have been developed for monitoring ground movement between foundations and within road embankments and earth dams.

Such systems require the cells and ancillary tubing to be installed during the course of the backfilling operations. To date, these systems have not been used in restored opencast sites partly because of the cost, but also because of the difficulties in installing a system of this type in an operating opencast site.

#### 4.4 GROUNDWATER MONITORING

Since the re-establishment of the water table may have an important influence on the settlement of the backfill, monitoring of the water table is often required. Normally this would be carried out by installing standpipe/piezometers in the site investigation boreholes. Again, remote monitoring could be

carried out using pneumatic piezometers. In some instances, open mineshafts or wells may be available close to the site for monitoring purposes.

#### 4.5 PERFORMANCE OF STRUCTURES

Monitoring the performances of structures on restored sites is a useful long term technique to verify the design assumptions made.

At Snatchill in Corby, structures were monitored to assess the performance of fill treated by different techniques (Charles et al, 1978). Large scale tests of this kind are likely to produce more representative results than those determined in conventional site investigations or by small levelling stations.

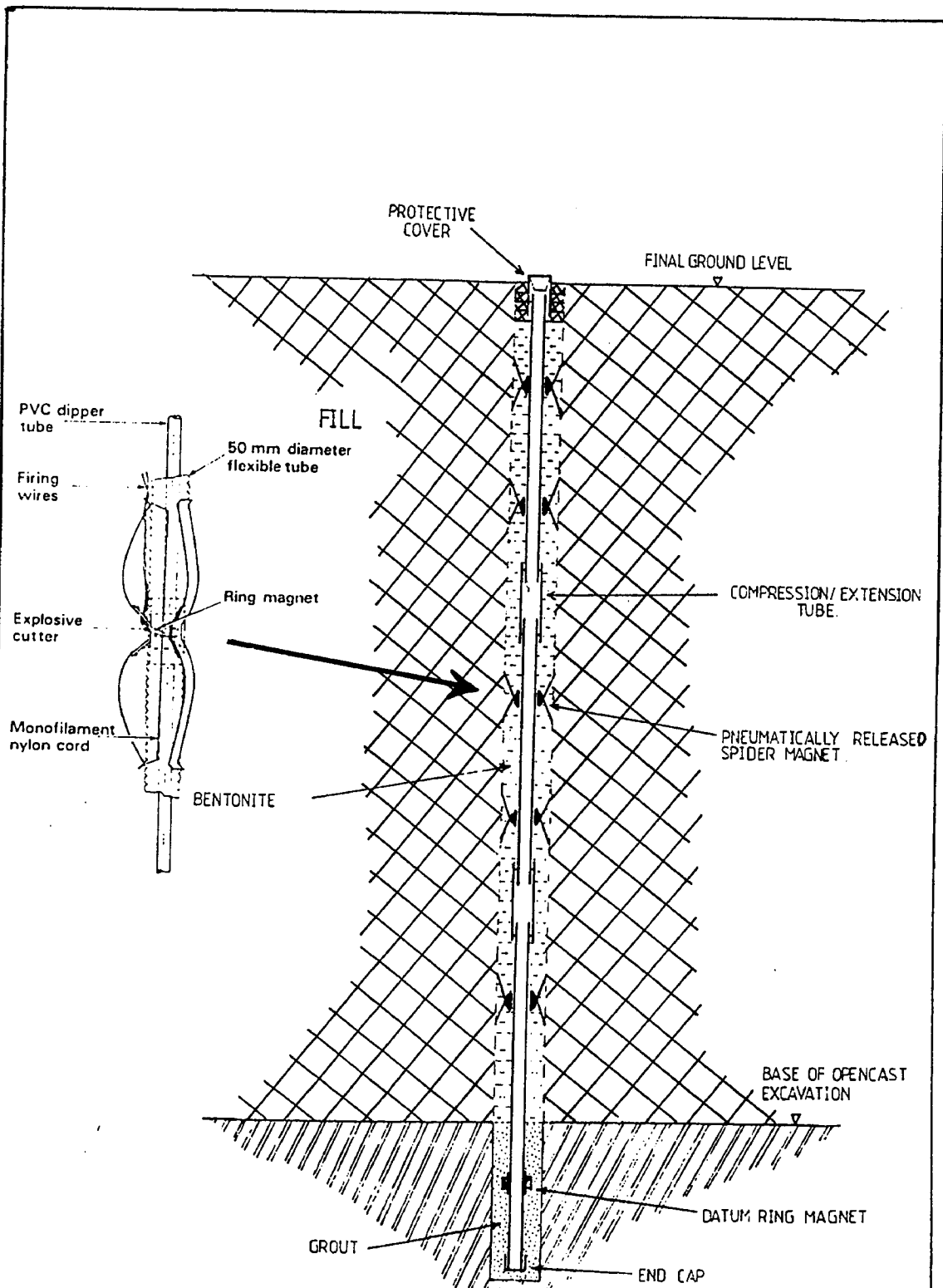

MAGNET EXTENSOMETER BOREHOLE SETTLEMENT GAUGE.

FIGURE 4.3.1.

## 5. CASE STUDY SITES

- 5.1 Introduction.
- 5.2 Holly Bank Opencast Site, Essington, South Staffordshire.
- 5.3 Hurst Opencast Site, Netherton, West Midlands.
- 5.4 Milking Bank Meadows (Phase IV), Dudley, West Midlands.



## 5.1 INTRODUCTION

In order to consider and develop the theories and assumptions made about the settlement of fills in opencast coal mining sites, three study sites in the West Midlands have been considered in detail by the writer. These sites are where, typically, the backfill has been placed in a controlled manner and where investigations and monitoring have been undertaken.

Details of the sites are presented in the following sections. Included are descriptions of the sites, their history and development, together with all of the test, investigation and monitoring results considered or obtained as part of this research.

The Holly Bank and Hurst sites were the main sites considered, both having just reached a point where there is sufficient settlement information available. Milking Bank Phase IV is part of a much larger opencast area restored much earlier and to a less comprehensive specification. The type and detail of information available at each has varied, as has the writer's involvement, i.e.

- Holly Bank - Principally the examination of opencast records and the monitoring of surface settlement.
- Milking Bank - Archive research, site investigations and settlement monitoring.
- Hurst - Control of the development of opencasting and backfilling together with testing and settlement monitoring.

## 5.2 HOLLY BANK OPENCAST SITE, ESSINGTON, SOUTH STAFFORDSHIRE

### 5.2.1 Introduction

The Holly Bank Opencast coal mining site is located on the outskirts of Essington in South Staffordshire. Under consideration is that portion of the site intended for subsequent housing development where, as a result, the backfill has been placed in a controlled manner and testing/monitoring has been undertaken.

### 5.2.2 Location and Description

The site is located approximately one-third of a mile south-east of Essington, which is a small village four miles north-east of Wolverhampton in the West Midlands; National Grid Reference SJ 966 031.

The area is located along the north-eastern side of Brownshore Lane and is a roughly rectangular parcel of land of about 13 acres. The full opencast site extended northward and eastward towards the M5 motorway, Figure 5.2.1.

Prior to opencast coalmining the area was a disused underground mining complex. Although the pit head gear had been removed some years ago, several spoil mounds and the route of former mineral railways could be seen at the surface. The land had a gradual fall in level towards the north-east and south.

On completion of opencast mining and restoration, the development area was left as a comparatively flat area with a gentle fall in level southward and eastward.

### 5.2.3 Geology

Prior to the opencast mining the site was covered with fill materials associated with its past use, these included ash and burnt shales. Thin natural superficial materials beneath the fill were typically glacial sands and gravels, these were underlain by weathered, then intact rocks of the Middle (Productive) Coal Measures of the Carboniferous Period. These rocks were essentially bedded and alternating mudstones, siltstones and sandstones but with several important mineral seams of coal, Figure 5.2.2.

The strata dip to the north-west at the shallow angle of about eight degrees. A major geological fault (the Mitre Fault) crosses the site, striking approximately north-east to south-west with the downthrow to the north-west being approximately 60 metres, Figures 5.2.3 and 5.2.4.

### 5.2.4 Past Underground Mining

The principal coal seams worked by underground methods in this area include the Top Robins, Bottom Robins, Wyrley Bottom, Old Park, Yard and Deep Coals.

Records (post-1873) indicate that these seams were extracted by the 'Longwall' method of mining, details of which are presented in Section 5.4. Seams located at shallow depth (including those named above) may have been worked in the past (pre-1873) by either the Longwall method or a form of 'Pillar and Stall' workings whereby

pillars of coal are left to support the roof. There would be a potential stability risk where such workings remain at shallow depths.

Eight mine shafts are recorded within the site area associated with the known mineworkings, only one is outside the opencast mined area, Figure 5.2.5.

#### 5.2.5 Opencast Mining Operations

The sequence of opencast mining operations was similar to that in Section 2.1. An initial 'box-cut' was made at the southern end of the opencast area, the overburden being placed in temporary storage. The excavation was then progressively advanced from south to north with the direct transfer of overburden to the backfilling area south of the excavation, following removal of the exposed coal seams. When the excavation reached the northern limit of the opencast area the remnant void was backfilled using the overburden materials from the initial temporary overburden tip.

Within the proposed residential area the total depth of the opencast excavation varied from 21 metres in the south-west to a maximum of 54 metres in the north-west. The full dip of the coal seams and, therefore, the base of the excavation was approximately 8 degrees to the north-west, south of the Mitre Fault, and 11 degrees to the north-west, north of the fault.

As a result of difficulties in the mining operation an internal highwall was formed extending upwards from the Top Robins Coal to the Chase Coals (approximately

34 metres). The depth to the top of the internal (buried) highwall varied between 19 and 22 metres from the final restoration level, Figure 5.2.5.

#### 5.2.6 Site Compaction and Controls

The specification upon which the site reclamation operations were carried out was based on the Series 600 Earthworks Specification contained in the 1976 Department of Transport 'Specification for Road and Bridgeworks'.

Prior to the commencement of restoration, full scale trials were carried out using the plant proposed for the compaction operations. This was in order to determine the amount of compaction necessary to achieve the optimum conditions indicated by laboratory compaction tests. Using towed vibrating rollers of 6.3 tonnes weight, it was established that three passes of the rollers would be sufficient to achieve the required dry densities.

Following completion of the coal extraction, the floor of each 'box-cut' was graded to remove any soft or unsuitable material. Overburden was then transported to the compaction area in motor scrapers or dump trucks, then spread out by a Caterpillar 825 compacter/grader to form layers not exceeding 300mm in thickness. Each layer was then compacted by the towed vibrating rollers, with a minimum of three passes. In order to achieve a moisture content as close as possible to the optimum value (11 to 14 percent), wet material was mixed with dry, or each

layer of dry material was sprayed with water.

The progressive layering and compaction operations were carried out on a number of benches or levels simultaneously. In order to maintain stability the overall slope profile did not exceed about 1 in 3.

Each embankment was 'keyed' into the adjacent higher embankment by excavating into the weathered loose material which accumulated on the exposed sloping face. The northern, eastern and southern side slopes of the compacted area were inclined at 2 vertical to 1 horizontal to intercept the base of the opencast excavation. The western side slope of the compacted fill was keyed into the western highwall of the excavation.

The surface limit of the compaction area is shown in Figure 5.2.6., as are the main backfill benches. A general summary of the dates and fill thickness for these benches is presented in Figure 5.2.7.

The areas of the opencast excavation to the north, east and south of the compaction area were loosely backfilled, no specific compactive effort being applied. The materials used for this backfilling included surplus materials and those considered unsuitable in the compaction area.

Daily measurements of the in-situ density and moisture content of the compacted materials was undertaken using a nuclear density gauge. Sand replacement tests as described in BS 1377 (1975) were also taken periodically throughout the compaction operations to check the results

obtained from the nuclear test gauge.

### 5.2.7 Monitoring

Eleven levelling stations were established within the restored land shortly after completion of backfilling in November 1983. A further forty-two stations were added in February 1984 when more detailed information was considered necessary.

The levelling stations comprised 15mm diameter mild steel bars 1.2 metres long driven into the ground, leaving 0.2 metres protruding. Surveys were referenced to two temporary bench marks established along Brownshore Lane.

Levels were taken at one, two and then three monthly intervals on the tops of the stations using a Zeiss 007 precise level which had a micrometer enabling readings to 0.0001m on an invar levelling staff.

The levelling was carried out so as to be self-checking and the results are shown in Figures 5.2.8 and 5.2.9 adjusted to the nearest 0.001m.

### 5.2.8 Settlement Observations

#### 5.2.8.1 General

In view of the intended residential development on this site, the results of the settlement monitoring have been considered to determine:

- (i) Within the main body of the controlled backfill, at what time interval after completion of backfilling were the amounts of total and differential settlement due to 'creep' settlement

sufficiently small that they could be accommodated by structures and services.

- (ii) In the vicinity of the highwalls to the former excavations, where considerable differential settlement could be expected, to determine the zone within which no structures should be placed.
- (iii) Whether any significant differential settlement would occur across the buried highwall.
- (iv) How the results from within the compacted fill area compare with the uncompacted area at the north-western end of the site.

#### 5.2.8.2 Allowable Settlement

The magnitude of the differential settlement is the principal control as to when development may proceed, and over what portion of the site it can be considered. The allowable differential settlement is dictated by the span designed for in a structure and the maximum allowable angular distortion adopted. In this instance a semi-raft type foundation was considered, capable of spanning across three metres, and adopting a maximum allowable angular distortion of  $1/500$ .

Providing a structure is not affected by excessive amounts of differential settlement, as defined above, the magnitude of total settlement which can be tolerated is considerable, the magnitude would be primarily dictated by the flexibility of service connections and the fall of drains.



### 5.2.8.3 Settlement in the Main Backfill Areas -

Plots of settlement against time are presented in Figures 5.2.10 to 5.2.16 for each of the main backfill areas defined on Figure 5.2.6. The results for Areas 2 to 4 have been combined in view of the limited number of stations within them, and the results for Area 8/9 have been spread onto three plots for clarity.

In examining the pattern of settlement exhibited by these plots, it is clear that the rate of settlement decreases with time; this is more markedly exhibited at those stations placed in the most recently completed areas. In addition, within the main body of individual backfill areas, the pattern and magnitude of settlement is remarkably similar. Variations are sometimes recorded but this is usually due to either the passage of site plant close to (or over) the station and possibly seasonal variations as caused by seasonal wetting and drying of the ground (e.g. Station 1).

In order to further analyse the results, the levelling stations have been divided on the bases of the fill thickness beneath each station, Figure 5.2.17. The settlement results for each fill thickness range have been plotted against time since completion of backfilling, Figures 5.2.18 to 5.2.22.

It is apparent that within each depth range the results from each station are very similar and that for each, the settlement effectively ceases 14 to 16 months after completion. The fact that there is such good correlation is an indication that the settlement characteristics and

compaction standards are relatively uniform.

Taking the mean settlement profile for each depth range (Figure 5.2.23) indicates that there is usually an increase in the magnitude of settlement with increasing fill thickness. The increase in settlement with each depth range is not great (less than 20mm) and the plot for the 40-50 metre range indicates less settlement than that indicated for shallower fills.

Since a linear relationship has been established on other sites when plotting settlement as a percentage of fill height against logarithm of time (Kilkenny, 1968 and Knipe, 1979) a plot of this kind has been produced using the mean plot for each fill thickness range, Figure 5.2.24. It can be seen that for each, a roughly linear relationship could apply up until 14 to 18 months after completion, beyond which, further settlement is effectively zero. It is also important to note that with increasing thickness of fill the settlement expressed as a percentage of the fill height decreases.

This relationship appears to hold true for each fill thickness range, although becoming less evident when the fill thickness exceeds about 40 metres. The amount of settlement which is indicated to occur after completion of backfilling at this site is as follows:

<u>Fill Thickness Range</u> (m)	<u>Settlement Expressed as Percentage</u> <u>of Fill Thickness (%)</u>
10 - 20	0.54
20 - 30	0.42
30 - 40	0.36
40 - 50	0.23
50 - 60	0.24

It should be noted that the relationships detailed above have been established from a composite presentation of the settlement data. This has been necessary because of the limited monitoring period. Although completion dates for the backfill areas ranged between July 1981 and September 1983, monitoring did not commence until November 1983. Hence, relative to the completion of backfilling, the monitoring period (twenty months) is between 0-2 years and 2-4 years, i.e.

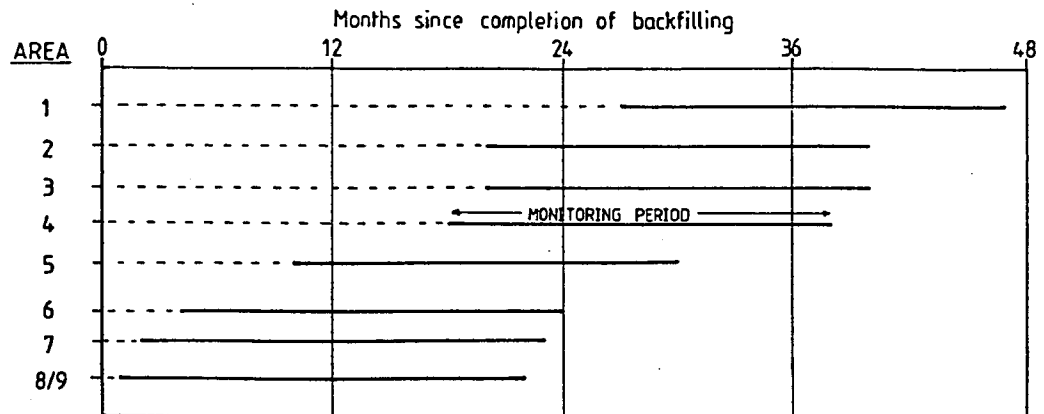

In compiling the composite plots of settlement v. time and settlement v. logarithm of time, for the various fill thickness categories, it has been possible to consider a maximum lapse time period of 4 years, more typically 2-3 years. Where there is insufficient data to provide a complete plot it has been extrapolated, based on the established linear relationship between settlement and the logarithm of time.

The magnitude of settlement, expressed as a percentage of fill height for each fill thickness range (detailed above) is thus used as a basis for predicting settlement profiles across highwalls, as detailed below.

#### 5.2.8.4 Settlement Close to Highwalls

Within the area of compacted backfill three section lines have been considered, E4, E5, and E6, the locations of which are shown on Figure 5.2.25. There are lines of settlement levelling pins placed at right angles to the highwall face, the interval between pins increasing away from the highwall, from 5-10 metres to 25-35 metres.

The plots of settlement against time are shown on Figures 5.2.26 to 5.2.28 and demonstrate progressively increasing settlement with increasing distance away from the highwall. This is also demonstrated on Figures 5.2.29 to 5.2.31 which illustrate the relationship between the station positions, the excavation profile and surface settlement for these sections.

Due to these sections being located close to site roads and early phases of housing development, many of the levelling stations were lost after only a few months. As a result, the settlement profiles along these sections are sparse. However, in order to demonstrate how these results relate to the highwall profile, a plot is included based on the settlement values (expressed as a percentage of fill thickness) determined for various thicknesses of fill referred to in section 5.2.8.3. From this plot it is clear that during the 14 to 16 month period after completion of backfilling the magnitude of differential settlement is considerable.

Based on the criteria defined in section 5.2.8.2., unacceptable amounts of differential settlement would occur immediately adjacent to the highwall. In these

sections the width of this zone would vary between about 10 and 30 metres, the amount being dictated by not only the fill thickness but the angle of the highwall face.

Lateral distance measurements have been taken between levelling stations just outside the backfill area and others some 30 to 45 metres inside the fill area, these are presented in Figure 5.2.9 and plotted in Figure 5.2.32. The results from these may be summarised as follows:

Section E4 - minor (+ or - 5mm) compression and  
(Pins 23 and 27) tension recorded from month 6 to 13.

Section E5 - slowly increasing compression up  
(Pins 30 and 34) until month 12 (maximum of 8mm)  
decreasing beyond this.

Section E6 - negligible compression and tension  
(Pins 41 and 45) between months 6 and 13, then  
increasing tension up until month 16  
with a maximum of 12mm.

There is insufficient information to draw any conclusions from these results. It is likely that the rapidly increasing extension recorded between 41 and 45 after the thirteenth month is due to site traffic rather than ground movement.

#### 5.2.8.5 Settlement Across Buried Highwall

Three sections have been considered which cross the buried highwall roughly at right-angles, these are sections E1, E2 and E7, as shown in Figure 5.2.25. As with the section lines described above, the spacing between levelling pins ranges between about 10 and 40 metres, the length increasing away from the buried highwall.

The plots of settlement against time for sections E1 and E2 (Figures 5.2.33 and 5.2.34) illustrate that the pattern of settlement across the buried highwall is very similar for each station and the magnitude of the variation between each is over a comparatively narrow range. Sections demonstrating the location of the pins relative to the base of excavation profile, indicating recorded and total anticipated settlement are shown on Figures 5.2.35 to 5.2.37. These sections show that although the buried highwall is a very marked feature, with differences in level either side of the wall being up to 35 metres, the differential settlement recorded and predicted is relatively minor. In no instance does the magnitude of differential settlement exceed the limit stipulated earlier and hence development need not avoid this feature. It should be noted that there is a fill cover above the buried highwall of between about 13 and 20 metres across these sections.

Lateral distance measurements (Figure 5.2.9) between pins along sections E1 and E2 are plotted on Figures 5.2.38 and 5.2.39. Minor amounts of both compression and extension are recorded but with no obvious pattern.

#### 5.2.8.6 Settlement of Uncompacted Fill

Levelling stations established in the small area of uncompacted fill at the north-eastern end of the site show markedly higher settlement figures than elsewhere on the site, Figure 5.2.40. There is a wide range of settlements recorded within this area partly because of the varying thickness of fill, but also because a number are underlain by both uncompacted and compacted fill as demonstrated on Section E3, Figures 5.2.41 and 5.2.42.

Where settlement had effectively ceased on the compacted fill area, appreciable movement was still taking place in this portion of the site. Station 18 is the one station available which is likely to be entirely underlain by uncompacted fill, and where its thickness is reasonably well known. From this station a much steeper straight line relationship is obtained when plotting settlement as a percentage of fill height against the logarithm of elapse time, Figure 5.2.24. Assuming that creep settlement will continue for about six years (Kilkenny, 1968) the total settlement in the uncompacted fill is expected to be 1.5 to 1.7 percent of the fill height. Lateral distance measurements (Figures 5.2.9, 5.2.43 and 5.2.44) show a clear pattern of compression centred over the area of greatest settlement (station 17 to 20) with tension recorded on the flanks (station 15 to 17 and 20 to 22). It should be noted that the greatest lateral movement occurred in that part of the section with the greatest contrast in fill thickness (stations 15 to 17).

Clearly, the magnitude of total and differential vertical movement and lateral displacements are such that this portion of the site will not be available for development for a number of years.

#### 5.2.8.7 Summary of Settlement Observations -

From the above analysis, the following conclusions may be drawn:

1. 'Creep' settlement becomes effectively zero within 14 to 18 months after completion of backfilling. Only seasonal variations appear to be recorded following this period.
2. A linear relationship has been confirmed on plotting settlement expressed as a percentage of fill height against logarithm of time.
3. With increasing thickness of fill the magnitude of creep settlement increases BUT settlement expressed as a percentage of fill height decreases, i.e. the magnitude of creep settlement does not increase in proportion to increasing fill thickness.
4. Relationships established from the above may be used to estimate the settlement profile across highwalls and buried highwalls. Correlation between these estimates and plotted results tends to be good.
5. The width of the zone alongside the highwall within which unacceptable amounts of differential settlement may occur (until creep settlement is essentially complete) varies between 10 and 30 metres. The width of this zone is dictated by the fill thickness and the angle of the highwall face.
6. The cover of fill above the buried highwall



(13-20 metres) would appear to minimise differential settlement across the highwall, despite very considerable variations in fill thickness (up to 35 metres).

7. Lateral movements do not appear to be significant across the highwall or buried highwall where the backfill is compacted.
8. The magnitude of creep settlement is far greater in the uncompacted fill and it takes far longer to complete. Lateral displacements are also appreciable, a distinct pattern of compression centred in the area of greatest settlement and tension along the flanks is recorded.



Aston University

**Content has been removed for copyright reasons**

SITE LOCATION PLAN - ESSINGTON.

Scale-1:10 000

FIGURE 5.2.1.

General Geological Succession

	Seam Name	Unworked Thickness(m)	Interval (m)
ETRURIA MARLS	-	-	-
MIDDLE COAL MEASURES:		-	45
	Lees Coal	0.5	
	Upper Chase Coal	0.85	2.6
	Middle Chase Coal	1.00	0.3
	Lower Chase Coal	0.45	2.2
	Wimbleb	0.45	20.1
	TOP ROBINS COAL	2.4	11.3
	BOTTOM ROBINS COAL	1.65	18.2
	Wyrley Yard Coal	1.4	9.3
	Upper Charles Coal	0.6	5.7
	Middle Charles Coal	0.5	3.3
	Lower Charles Coal	0.6	2.9
	Brooch Coal	1.15	10.8
	Benches Coal	0.75	17.5
	WYRLEY BOTTOM COAL	2.4	18.0
	Little Coal	0.9	7.0
	OLD PARK COAL	1.4	7.0
	Heathen Coal	0.75	14.0
	Stinking coal	0.45	15.0
LOWER COAL MEASURES:			
	YARD COAL	0.75	6.0
	Bass coal	0.6	8.0
	Cinder Coal	+ 0.30	13.0
	BOTTOM COAL	2.4	6.0

GENERAL GEOLOGICAL SUCCESSION

ESSINGTON

FIGURE 5-2-2.



Aston University

**Content has been removed for copyright reasons**

GENERAL GEOLOGY AND EXTENT OF OPENCAST AREA  
ESSINGTON.

FIGURE 5.2.3.

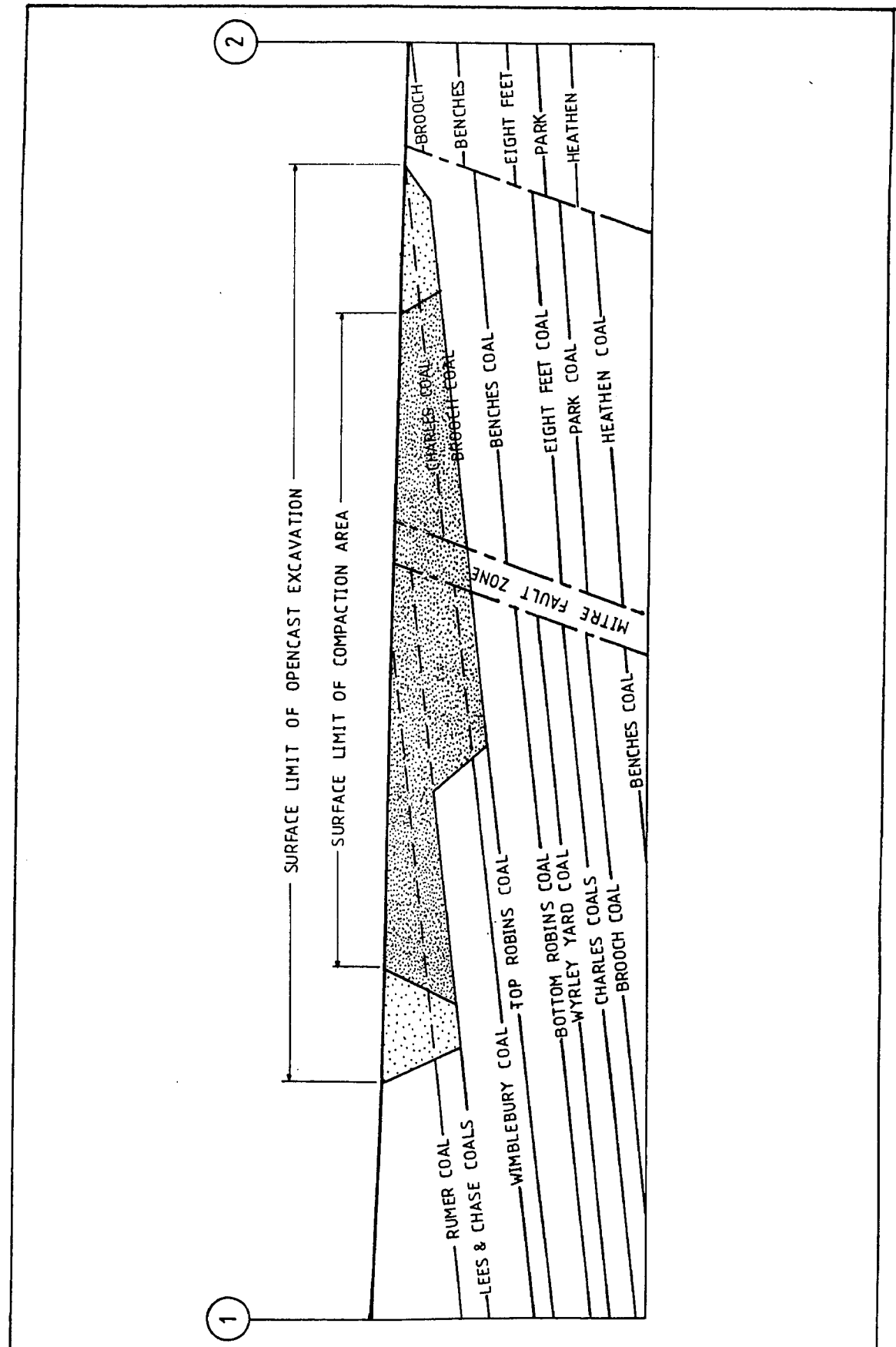

GEOLOGICAL SECTION - ESSINGTON.

Scale: Natural

FIGURE 5.2.4.

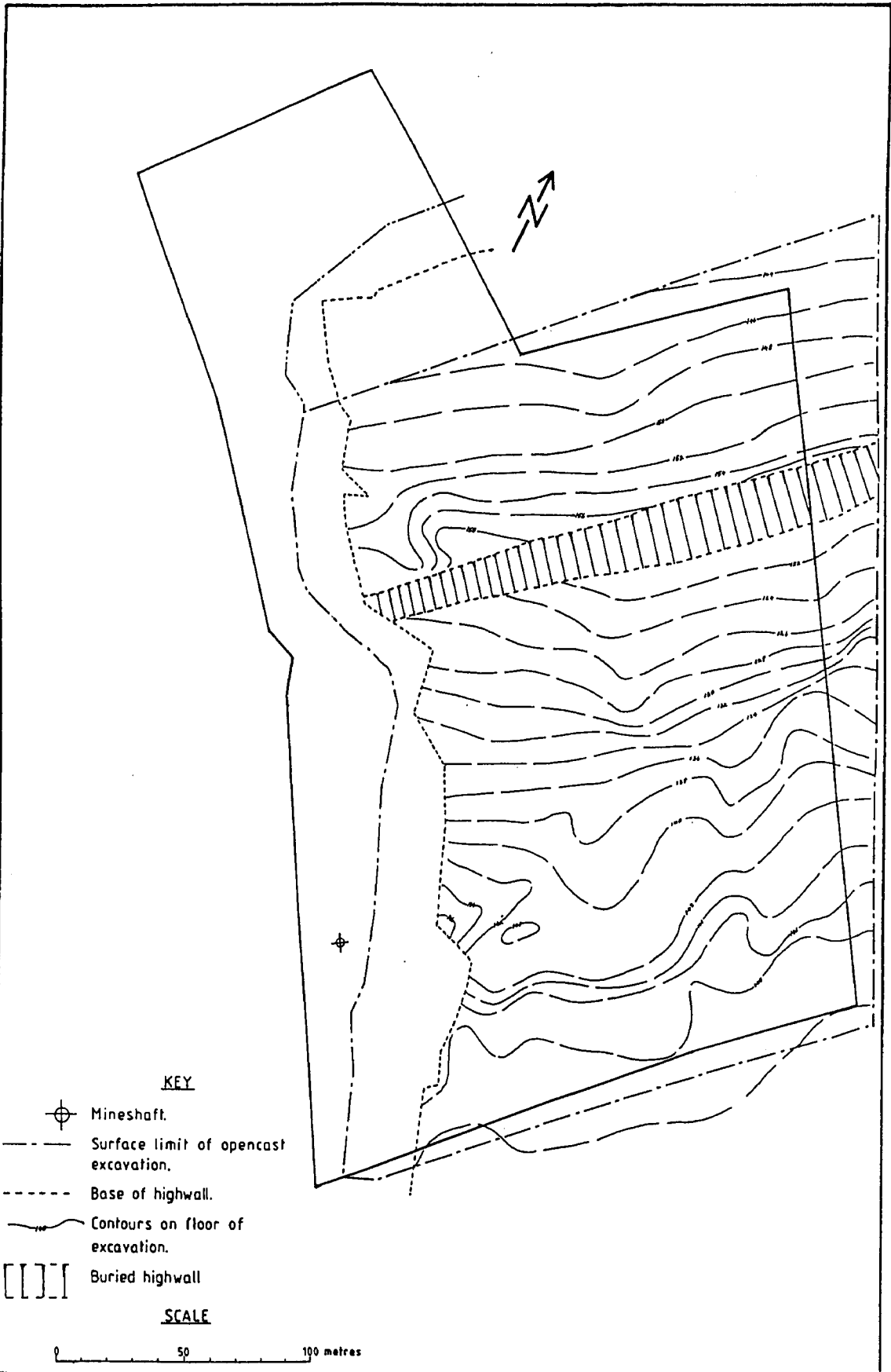

CONTOURS ON FLOOR OF OPENCAST EXCAVATION  
 ESSINGTON.

FIGURE 5-2-5.

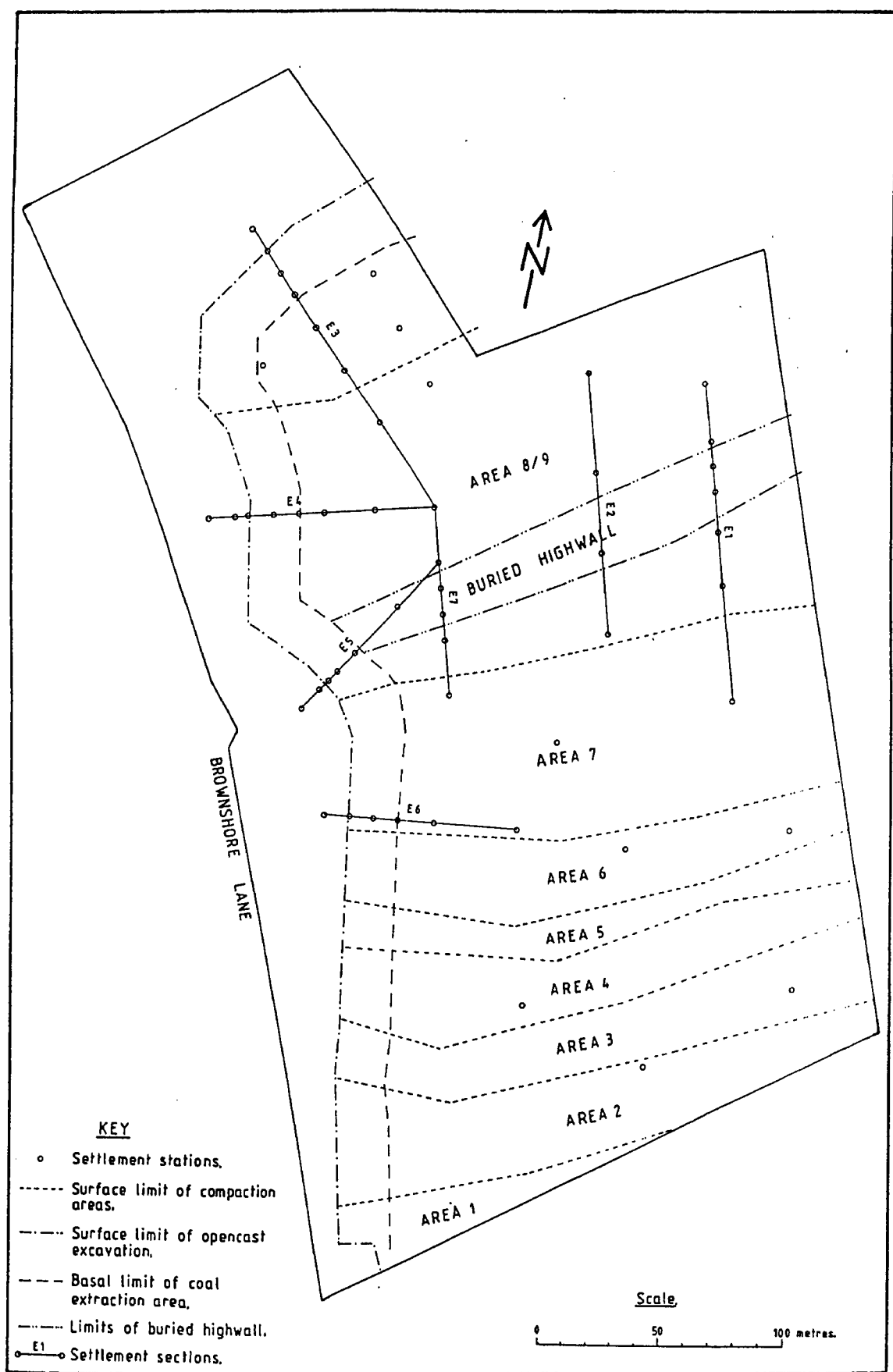

PLAN SHOWING BACKFILL AREAS - ESSINGTON.

FIGURE 5-2-6.

General Details - Backfill Areas at Essington

Areas	Commencement of Backfilling	Completion of Backfilling	Time taken for backfill (months)	Thickness of fill (m)
1.	November 1980	July 1981	7 - 9	23
2.	February 1981	February 1982	10 - 12	23 - 25
3.	March 1981	February 1982	9 - 11	25 - 30
4.	May 1981	April 1982	9 - 11	27 - 34
5.	October 1981	December 1982	12 - 14	30 - 33
6.	April 1982	June 1983	13 - 15	25 - 36
7.	August 1982	August 1983	10 - 12	39 - 46
8/9.	January 1983	September 1983	7 - 9 )	South of Buried Highwall = 47 - 52 North of Buried Highwall = 17 - 30

NOTE Areas 1 - 4 surcharged by about 2 metres of material until August 1983.

GENERAL DETAILS OF BACKFILL AREAS  
ESSINGTON.

FIGURE 5.2.7.



STN NO.	2.11.83	5.12.83	9.01.84	9.02.84	10.4.84	19.6.84	29.8.84	16.10.84	3.1.85	21.3.85	11.6.85	Latest Movement Omm	Total Movement Omm
Bolt C	172.195	172.196	172.195	172.155	172.155	172.155	172.155	172.155	172.155	172.155	172.155		
Bolt 8	173.208	173.209	173.209	173.208	173.209	173.209	173.205	173.207	173.200	173.200	173.200		
1	173.523	173.521	173.518	173.514	173.511	173.508	173.501	173.501	174.783	175.822	175.819	- 3	-48
2	174.841	174.838	174.835	174.835	174.828	174.824	174.817	174.816	174.821	175.821	175.819		
3	175.867	175.862	175.856	175.851	175.846	175.841	175.832	175.823	175.821	175.822	175.819		
4	174.118	174.108	174.101	174.094	174.087	174.078	174.071	174.067	174.931	174.933	174.930	- 3	-70
5	175.000	174.988	174.979	174.970	174.962	174.952	174.942	174.933	174.931	174.933	174.930		
6	175.097	175.080	175.068	175.058	175.048	175.039	175.027	175.017	175.181	175.182	175.182	0	-60
7	175.242	175.229	175.220	175.212	175.206	175.199	175.192	175.183	174.273	174.275	174.275	+ 1	-62
8	174.338	174.324	174.314	174.307	174.299	174.292	174.284	174.281	175.622	175.622	175.622	0	-72
9	175.694	175.682	175.672	175.664	175.656	175.648	175.635	175.624	175.044	175.044	175.044	+ 1	-61
10	175.106	175.095	175.085	175.078	175.072	175.065	175.055	175.046	173.394	173.393	173.396	- 7	-99
11				173.485	173.455	173.435	173.421	173.413	173.421	173.654	173.655	- 7	-85
12				173.733	173.711	173.694	173.681	173.672	173.654	173.654	173.648	- 7	-38
13				174.357	174.347	174.340	174.333	(174.140	174.140	174.140	174.136	- 4	+9
14				173.729	173.730	173.731	173.732	173.732	173.732	173.738	173.738	0	-78
15				173.545	173.529	173.515	173.502	173.493	173.470	173.474	173.467	- 7	-116
16				173.240	173.206	173.181	173.162	173.151	173.142	173.131	173.124	- 7	
17				173.192	173.146	173.110	173.082	173.065	173.045	173.042	173.042	- 7	
18				173.154	173.119	173.095	173.075	173.065	173.045	173.045	173.042	- 7	
19				173.423	173.408	173.396	173.385	173.378	173.363	173.364	173.358	- 6	-65
20				174.022	174.012	174.003	173.995	173.992	173.982	173.983	173.984	+ 1	-38
21				173.010	172.981	172.968	172.956	172.949	173.982	173.982	173.984		
22				172.927	172.928	172.926	172.927	172.927	173.982	173.982	173.984		
23				173.120	173.119	173.116	173.116	173.116	173.116	173.116	173.116		
24				173.148	173.145	173.141	173.139	173.138	173.138	173.138	173.138		
25				173.323	173.318	173.311	173.308	173.308	173.308	173.308	173.308		
26				173.474	173.467	173.459	173.455	173.455	173.455	173.455	173.455		
27				173.763	173.753	173.744	173.738	173.733	173.733	173.733	173.733		
28				174.083	174.073	174.063	174.056	174.056	174.056	174.056	174.056		
29				173.704	173.705	173.701	173.697	173.696	173.696	173.696	173.696		
30				173.750	173.750	173.745	173.741	173.739	173.739	173.739	173.739		
31				173.743	173.743	173.737	173.733	173.731	173.731	173.731	173.731		
32				173.762	173.761	173.755	173.750	173.748	173.748	173.748	173.748		
33				173.691	173.687	173.681	173.676	173.674	173.674	173.674	173.674		
34				173.966	173.960	173.952	173.946	173.942	173.942	173.942	173.942		
35				174.284	174.276	174.266	174.258	174.254	174.254	174.254	174.254		
36				174.208	174.201	174.194	174.184	174.177	174.177	174.177	174.177		
37				174.274	174.267	174.258	174.248	174.242	174.242	174.242	174.242		
38				174.190	174.183	174.175	174.164	174.157	174.157	174.157	174.157		
39				174.991	174.984	174.978	174.970	174.967	174.967	174.967	174.967		
40				173.661	173.662	173.656	173.654	173.653	173.653	173.653	173.653		
41				173.812	173.813	173.806	173.805	173.803	173.803	173.803	173.803		
42				173.934	173.934	173.929	173.926	173.924	173.924	173.924	173.924		
43				173.950	173.947	173.938	173.933	173.927	173.927	173.927	173.927		
44				174.101	174.097	174.086	174.079	174.074	174.074	174.074	174.074		
45				174.453	174.449	174.437	174.429	174.428	174.428	174.428	174.428		
46				176.288	176.284	176.279	176.270	176.258	176.258	176.258	176.258		
47				175.232	175.233	175.232	175.230	175.220	175.220	175.220	175.220		
48				175.880	175.871	175.862	175.852	175.852	175.852	175.852	175.852		
49				175.782	175.772	175.757	175.747	175.736	175.736	175.736	175.736		
50													

SUMMARY OF SETTLEMENT RESULTS  
ESSINGTON

FIGURE 5.2.8.

# SUMMARY OF SETTLEMENT RESULTS ESSINGTON

FIGURE 5-2-9.

STN NO.	2.11.83	5.12.83	9.01.84	9.02.84	10.4.84	19.6.84	29.8.84	16.10.84	3.1.85	21.3.85	11.6.85	Latest Movement	Total Movement
51				175.877	175.865	175.854	175.840	175.829	175.825	175.825	175.823	- 2mm	-54mm
52				175.895	175.881	175.869	175.855	175.843	175.839	175.839	175.837	- 2	-58
53				175.803	175.791	175.781	175.767	175.756	175.753	175.753	175.752	- 1	-51
	Lateral Movement												
6		30.205	30.206	30.192	30.204	30.202	30.203	30.201					
7		29.981	29.984	29.983	29.984	29.984	29.983	29.990					
8		39.936	39.938	39.935	39.935	39.933	39.933	39.927	39.930	39.931	39.927	- 4	- 9
11		48.349	48.351	48.347	48.346	48.342	48.343	48.344	48.349	48.343	48.343	0	- 6
15				45.049	45.037	45.039	45.036	45.042	45.049	45.048			
23				35.081	35.079	35.085	35.082						
30				30.144	30.143	30.141	30.136	30.140					
41				45.131	45.133	45.132	45.129	45.133	45.143	10.083	10.085	+ 2	+23
15							10.062	10.073	10.084	10.083	10.085	+ 2	+23
16							9.967	9.966	9.970	9.970	9.974	+ 4	+ 7
17							9.988	9.985	9.983	9.978			
18							15.019	15.018	15.015	15.017			
19							19.926	19.923	19.920	19.916			
20							24.962	24.961	24.969	24.968	24.974	+ 6	+12
21							40.197	40.200	40.182	40.197			
10							22.962	40.200					
49							10.055						
50							9.970	9.969	9.974	9.968	9.971	+ 3	+ 1
51							14.976	14.979	14.974	14.977	14.972	- 5	+ 1
52							20.021	20.021	20.021	20.017	20.020	+ 3	- 1
53							43.764	43.767	43.767	43.765	43.758	- 7	- 6
50							33.017	33.017	33.017	33.022	33.021	- 1	+ 4
6							60.186	60.181	60.190	60.192	60.191	- 1	+ 5

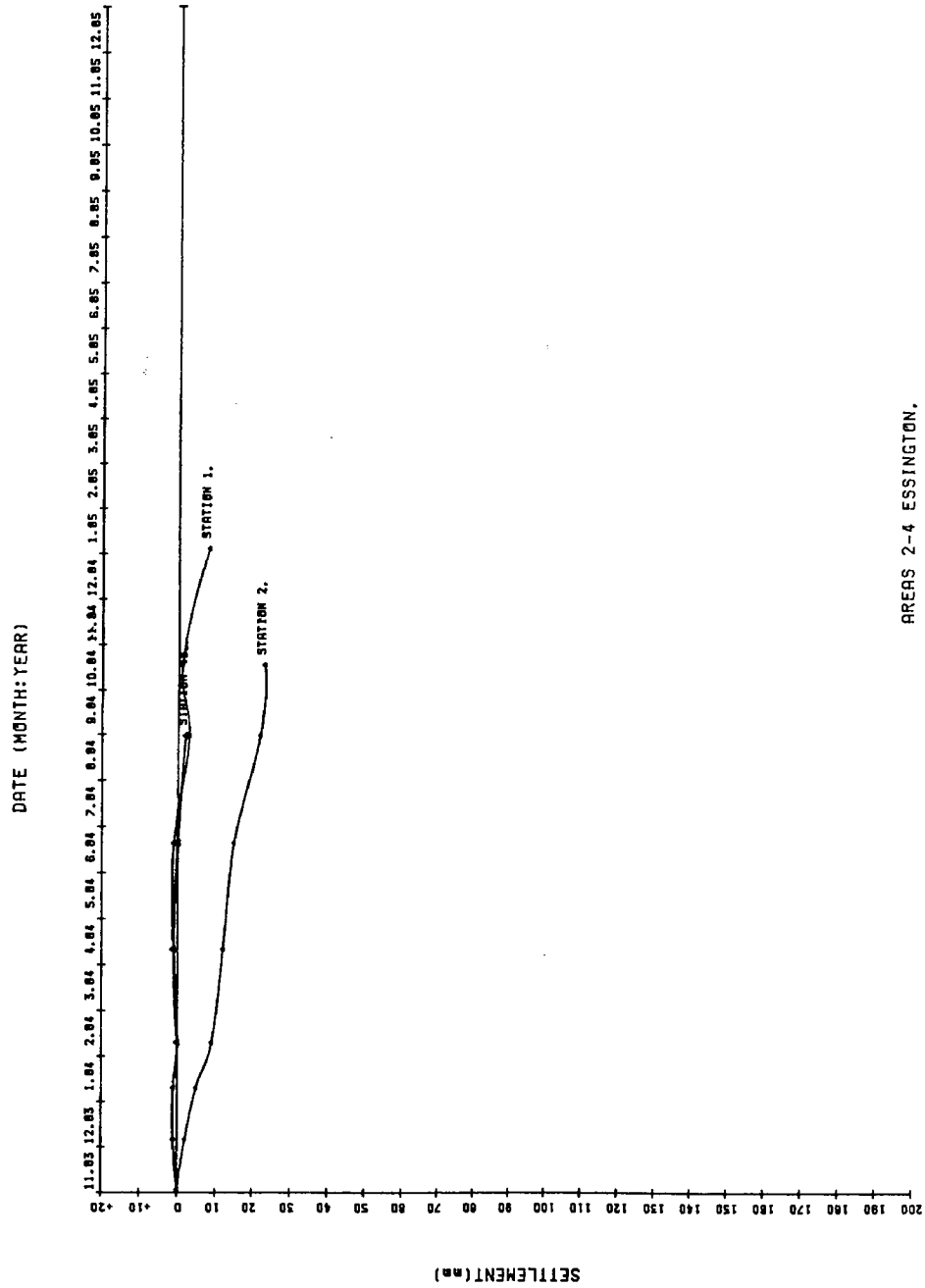

AREAS 2-4 ESSINGTON.

SETTLEMENT v TIME  
AREAS 2-4 ESSINGTON.

FIGURE 5-2-10.

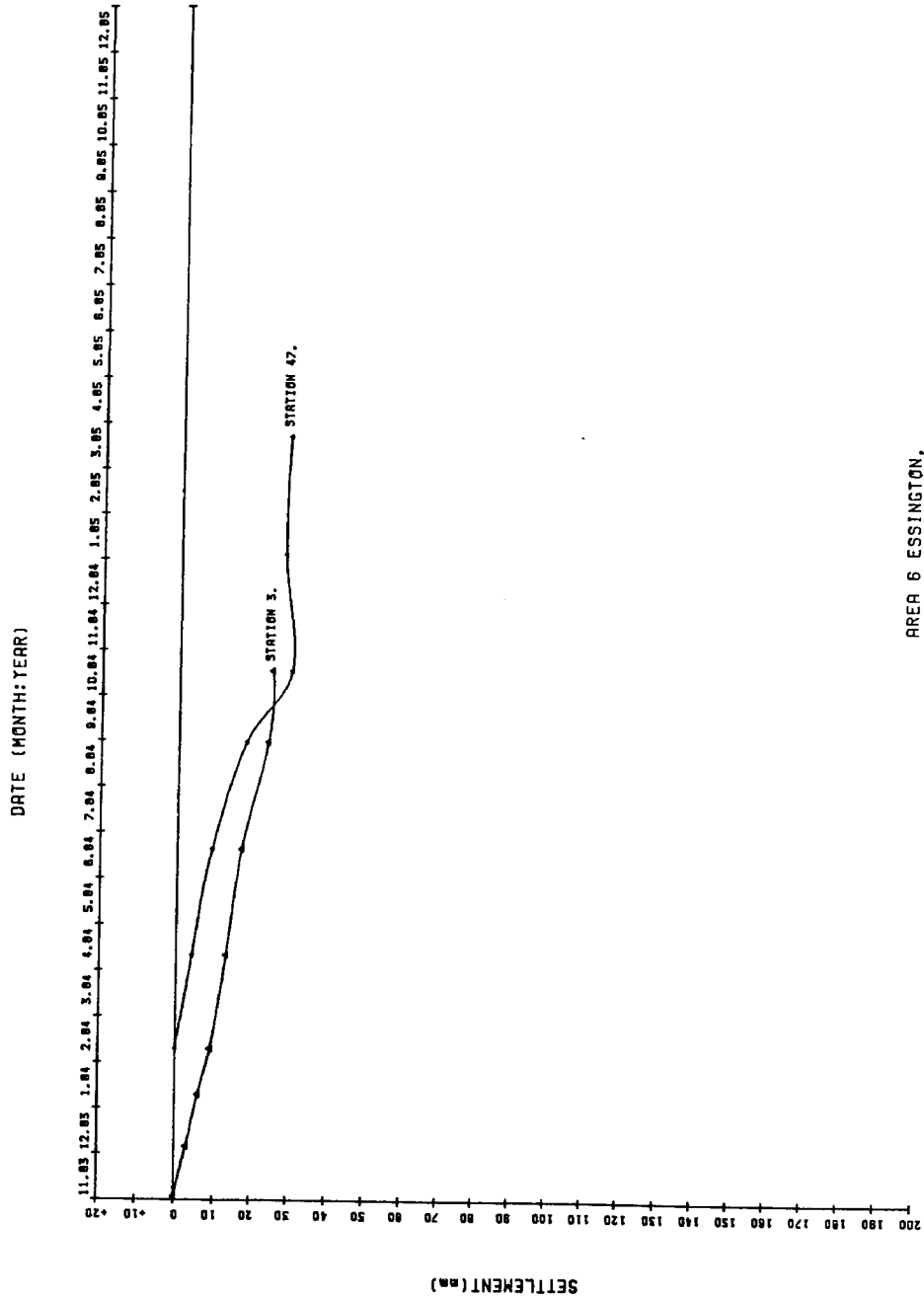

SETTLEMENT v TIME  
AREA 6, ESSINGTON

FIGURE 5-2-11.

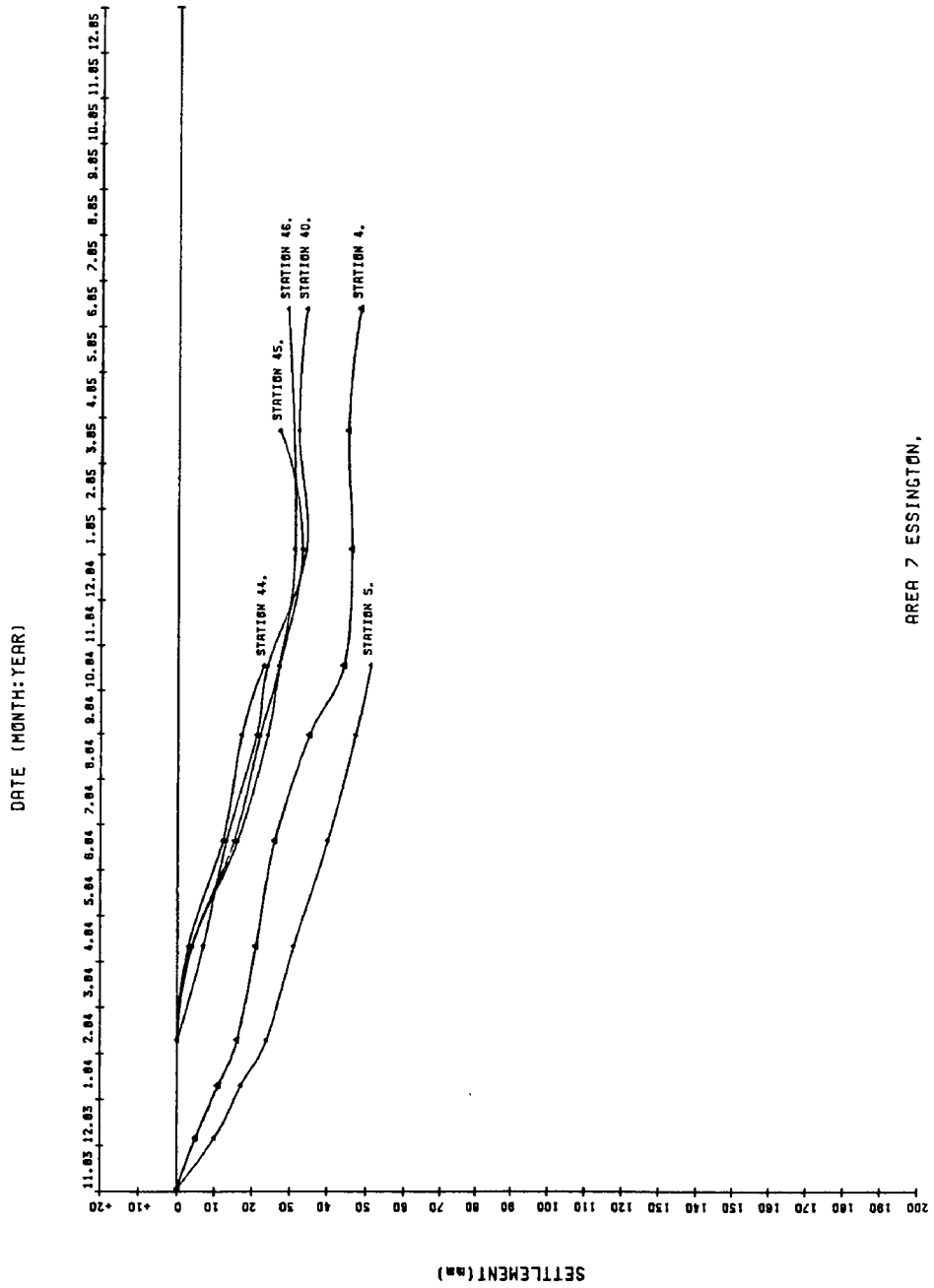

AREA 7 ESSINGTON.

SETTLEMENT v TIME  
AREA 7, ESSINGTON.

FIGURE 5-2-12.

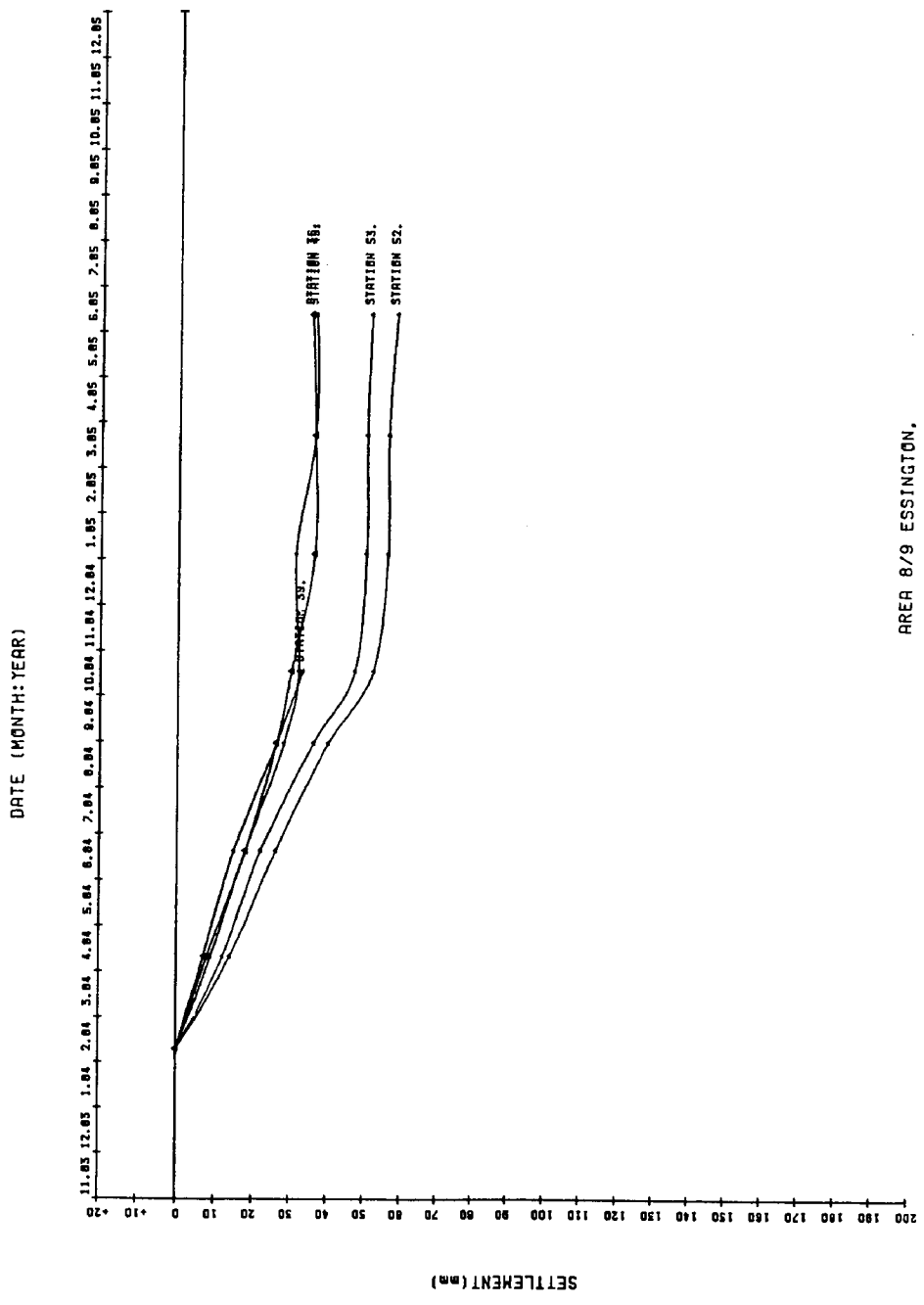

AREA 8/9 ESSINGTON.

SETTLEMENT v TIME  
AREA 8/9 ESSINGTON

FIGURE 5.2.13.

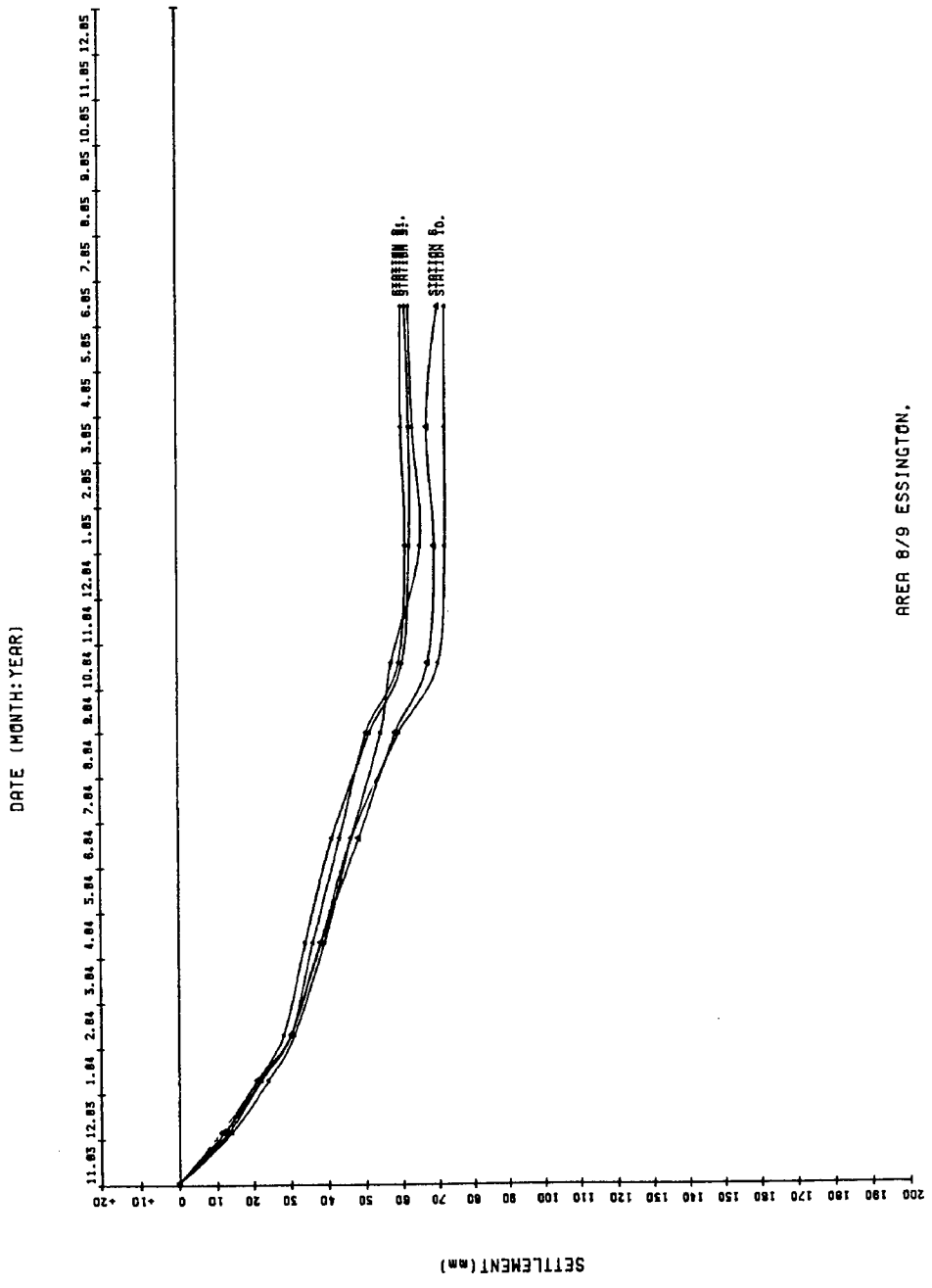

AREA 8/9 ESSINGTON.

SETTLEMENT v TIME  
AREA 8/9 ESSINGTON

FIGURE 5-2-15.

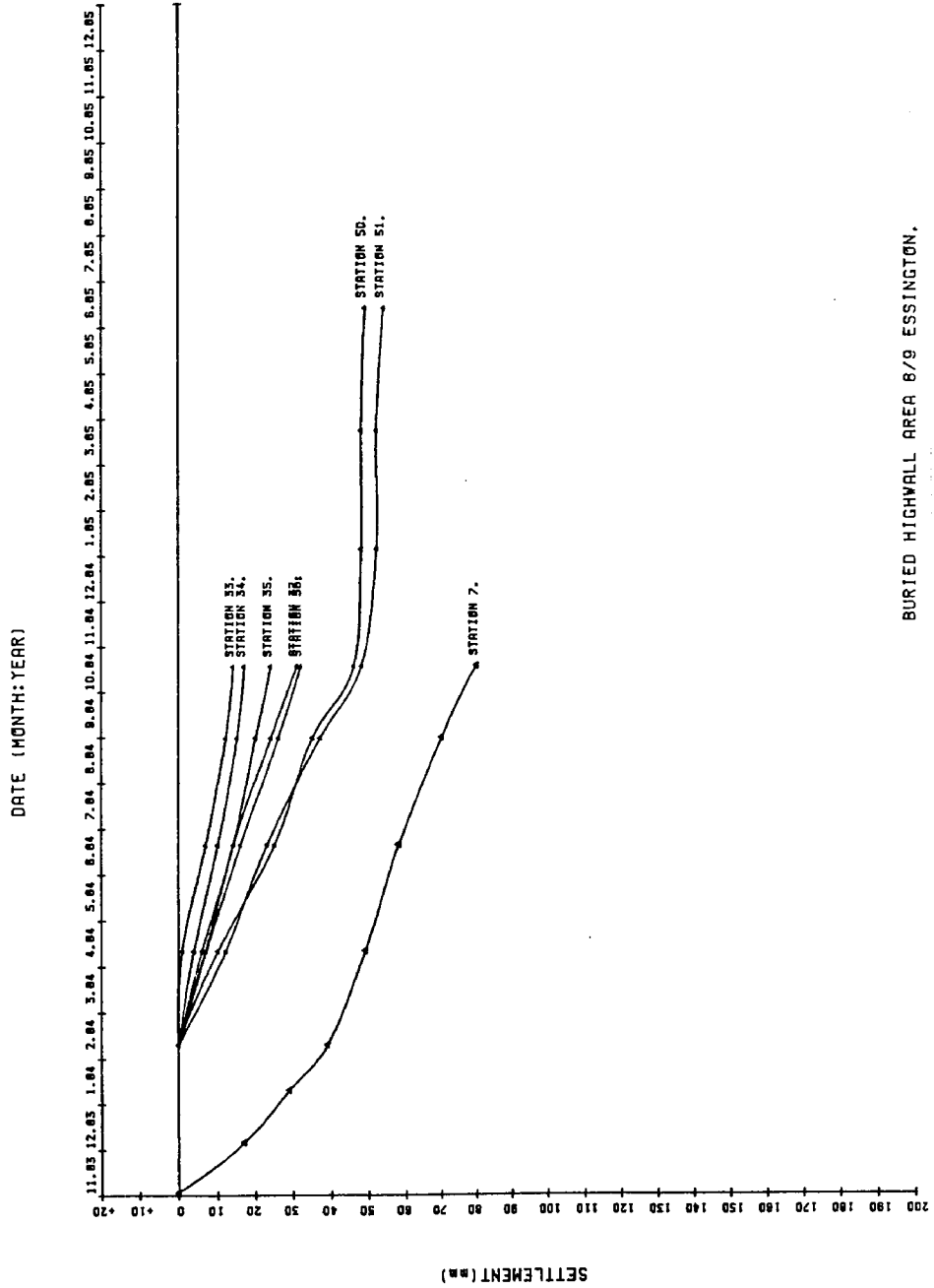

BURIED HIGHWALL AREA 8/9 ESSINGTON.

SETTLEMENT v TIME  
BURIED HIGHWALL-AREA 8/9, ESSINGTON.

FIGURE 5-2-16.



ESTIMATED THICKNESS OF FILL AT SETTLEMENT STATIONS

<u>Station No.</u>	<u>Fill Thickness (m)</u>	<u>Station No.</u>	<u>Fill Thickness (m)</u>
1	26.8	28	23.0
2	33.5	29	22.5
3	36.8	30	1.5
4	45.1	31	5.0
5	47.1	32	20.5
6	52.3	33	36.0
7	38.0	34	33.0
8	23.0	35	16.0
9	22.2	36	16.7
10	25.5	37	14.2
11	28.5	38	30.0
12	32.6	39	49.5
13	30.3	40	43.8
14	28.2	41	1.7
15	1.2	42	1.7
16	2.3	43	14.0
17	13.5	44	28.0
18	25.0 (Uncompacted)	45	40.0
19	31.5 (approx 24m uncompacted)	46	38.9
20	29.5 (approx 4m uncompacted)	47	35.4
21	26.8	48	29.4
22	29.8	49	22.4
23	1.0	50	19.8
24	1.5	51	32.7
25	3.0	52	52.5
26	19.5	53	53.2
27	23.5		

ESTIMATED THICKNESS OF FILL AT SETTLEMENT STATIONS  
ESSINGTON

FIGURE 5-2-17

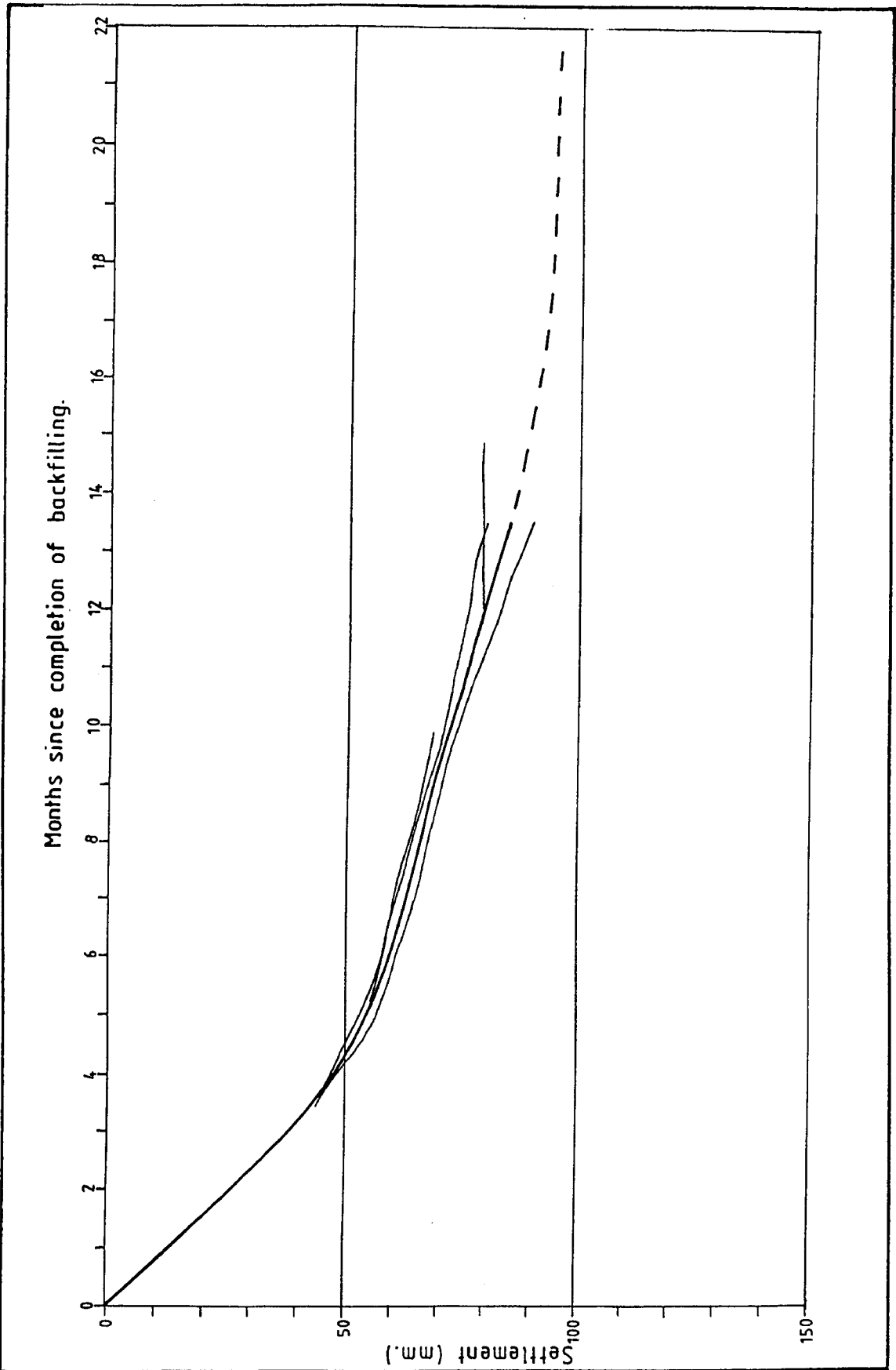

SUMMARY OF SETTLEMENT RESULTS - ESSINGTON.  
FILL THICKNESS 10 - 20 metres.

FIGURE 5-2-18.

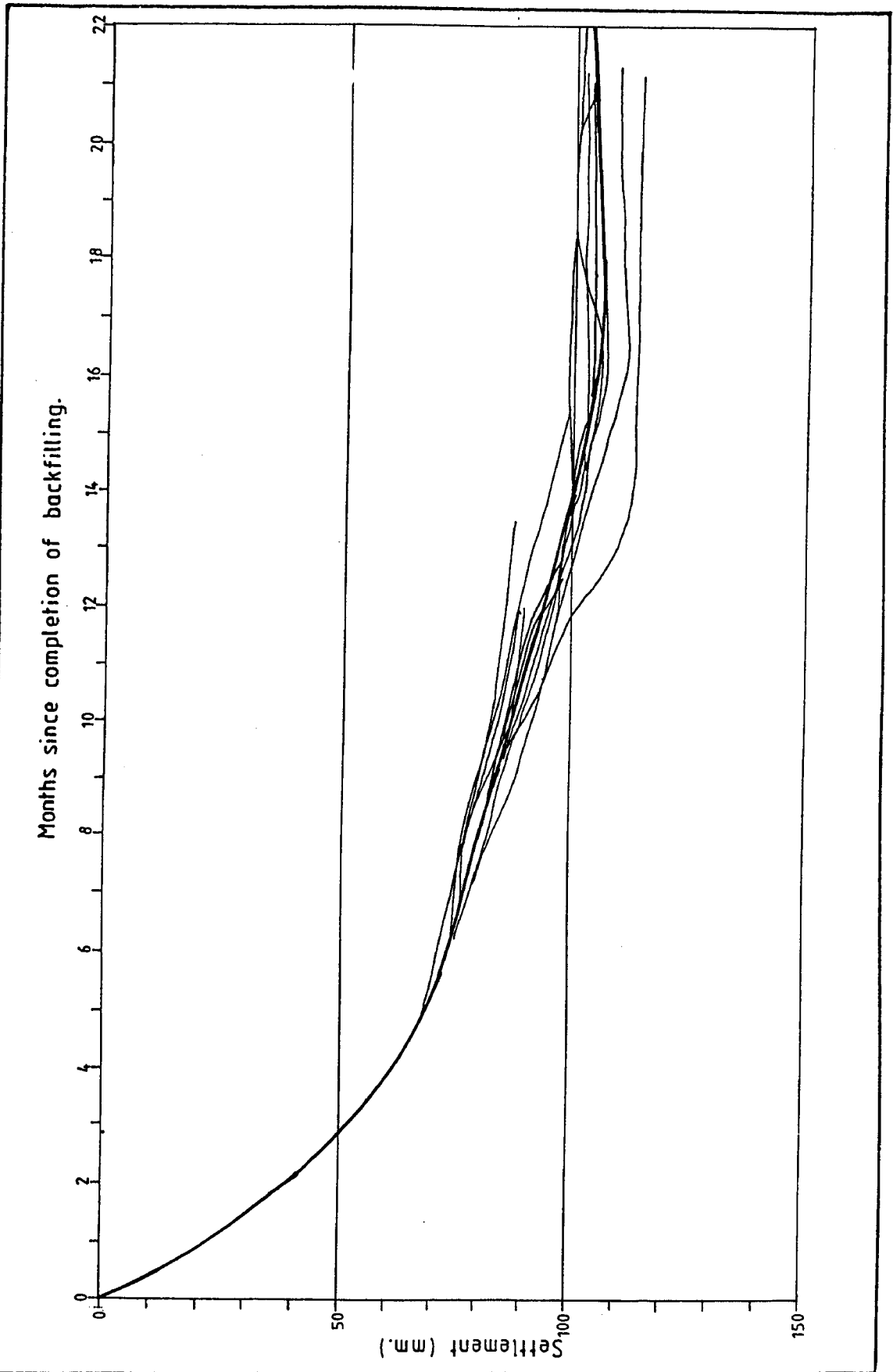

SUMMARY OF SETTLEMENT RESULTS - ESSINGTON.  
FILL THICKNESS 20-30 metres.

FIGURE 5-2-19.

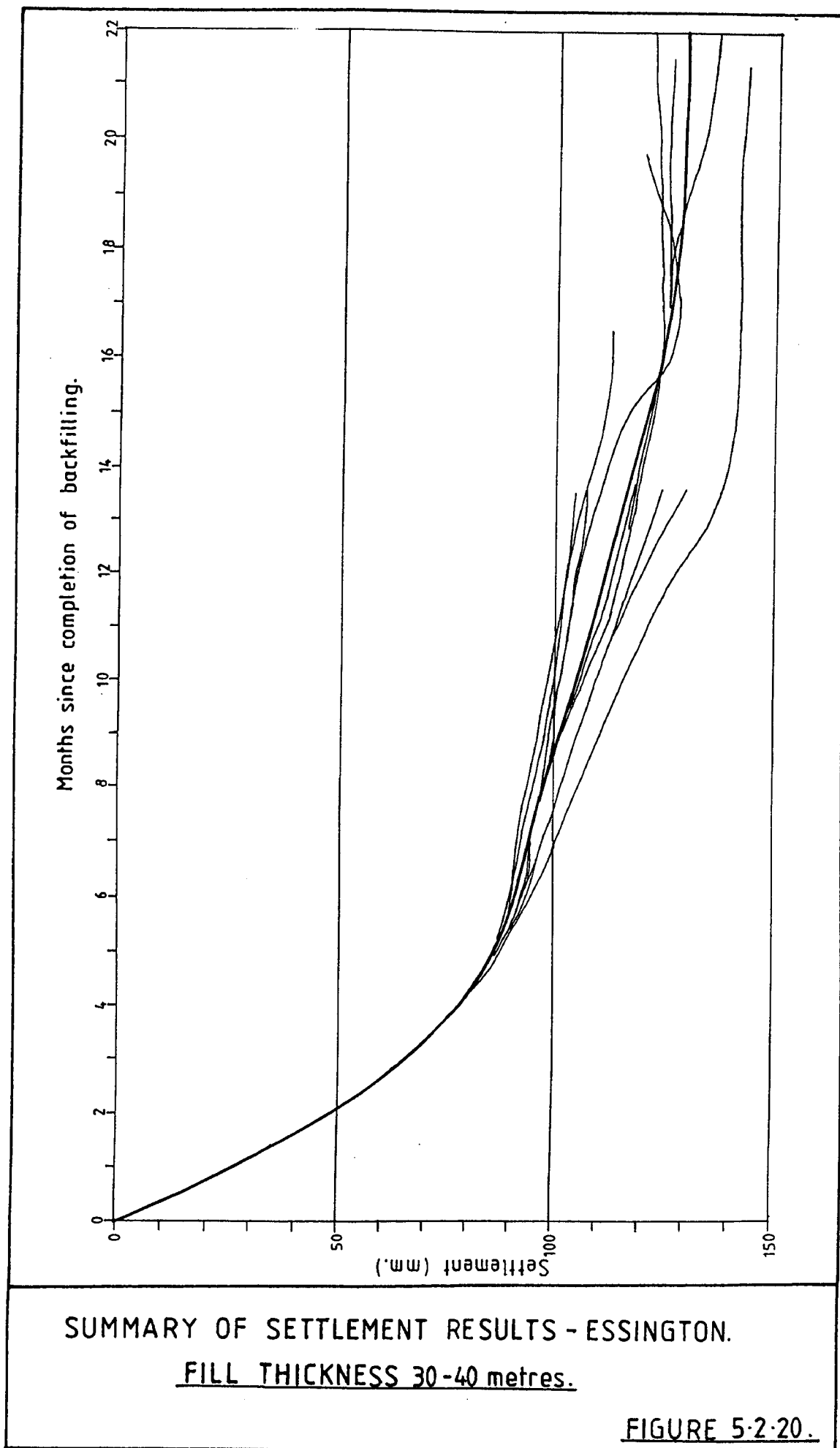

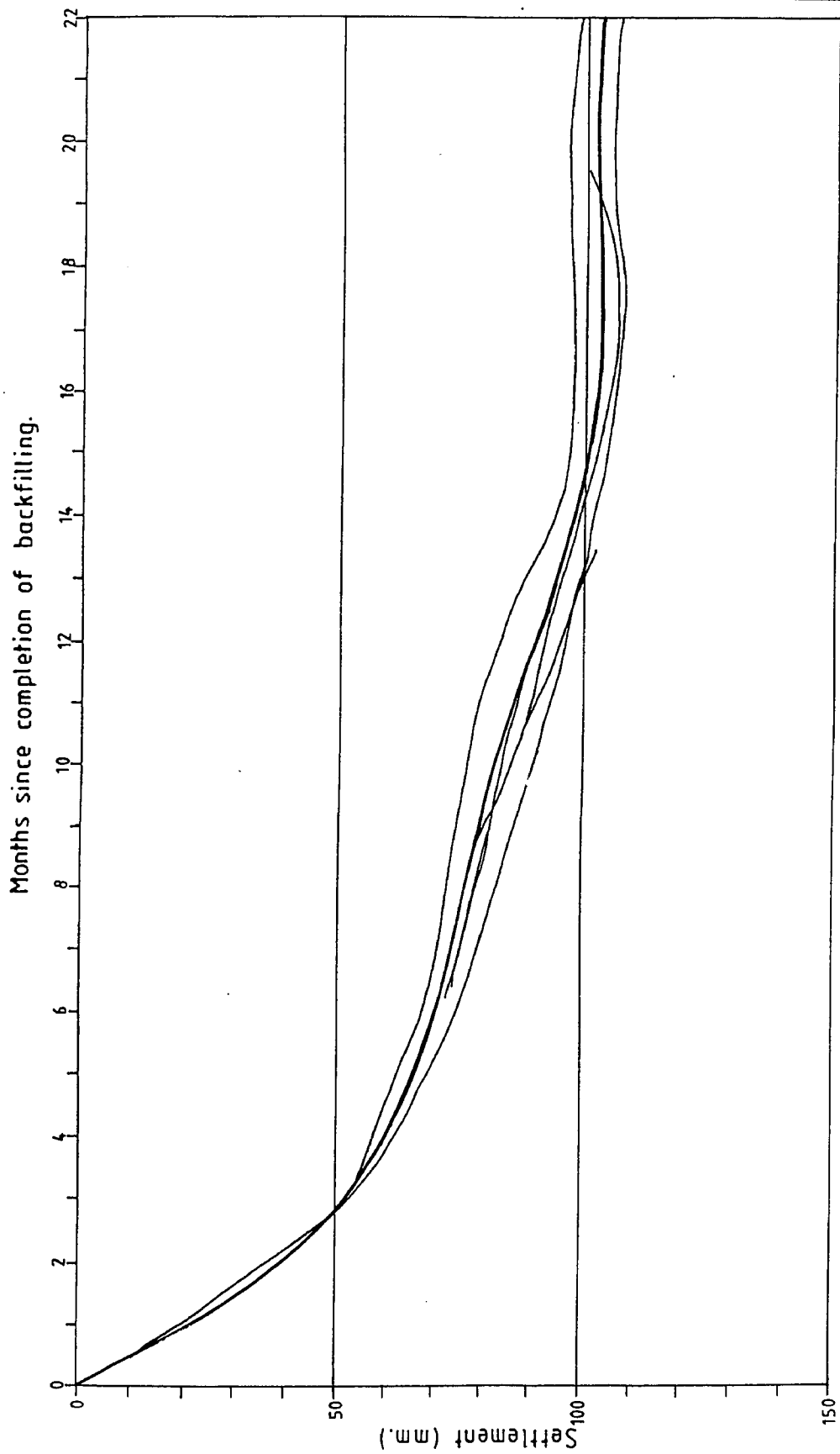

SUMMARY OF SETTLEMENT RESULTS - ESSINGTON.  
FILL THICKNESS 40-50 metres.

FIGURE 5-2-21.

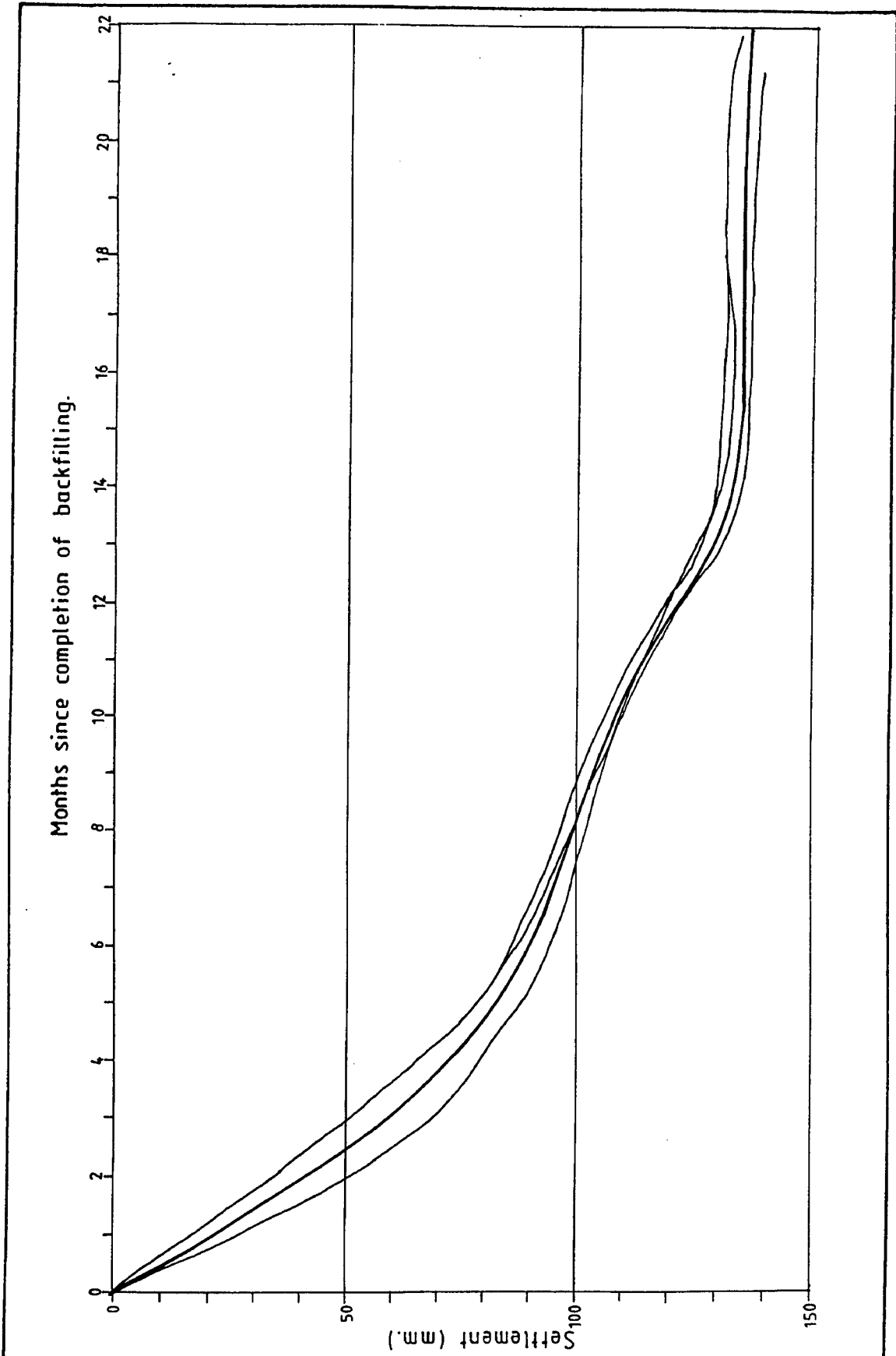

SUMMARY OF SETTLEMENT RESULTS - ESSINGTON.  
FILL THICKNESS 50-60 metres.

FIGURE 5-2-22.

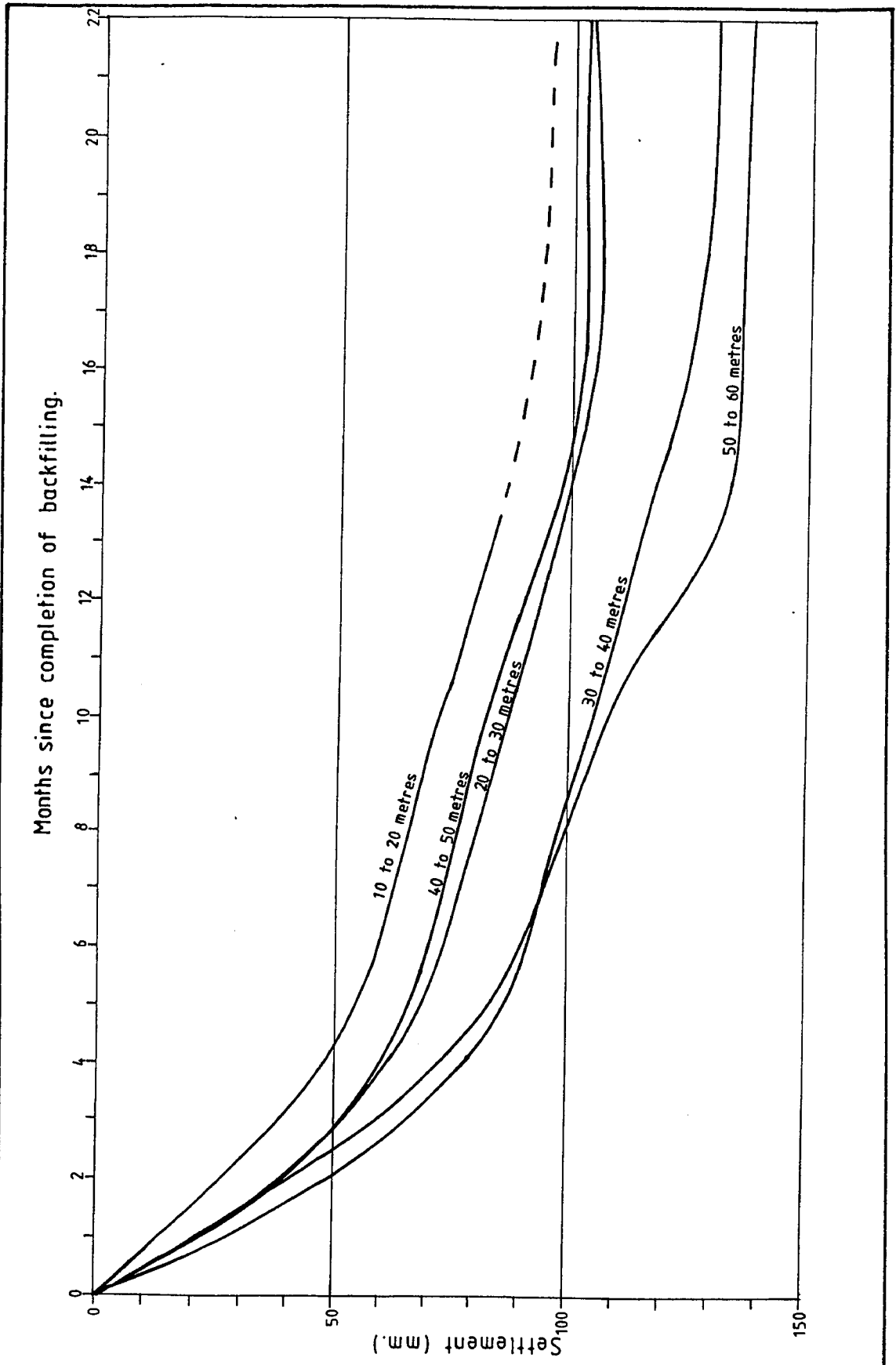

MEAN SETTLEMENT RESULTS FOR FULL RANGE OF  
FILL THICKNESSES - ESSINGTON.

FIGURE 5-2-23.

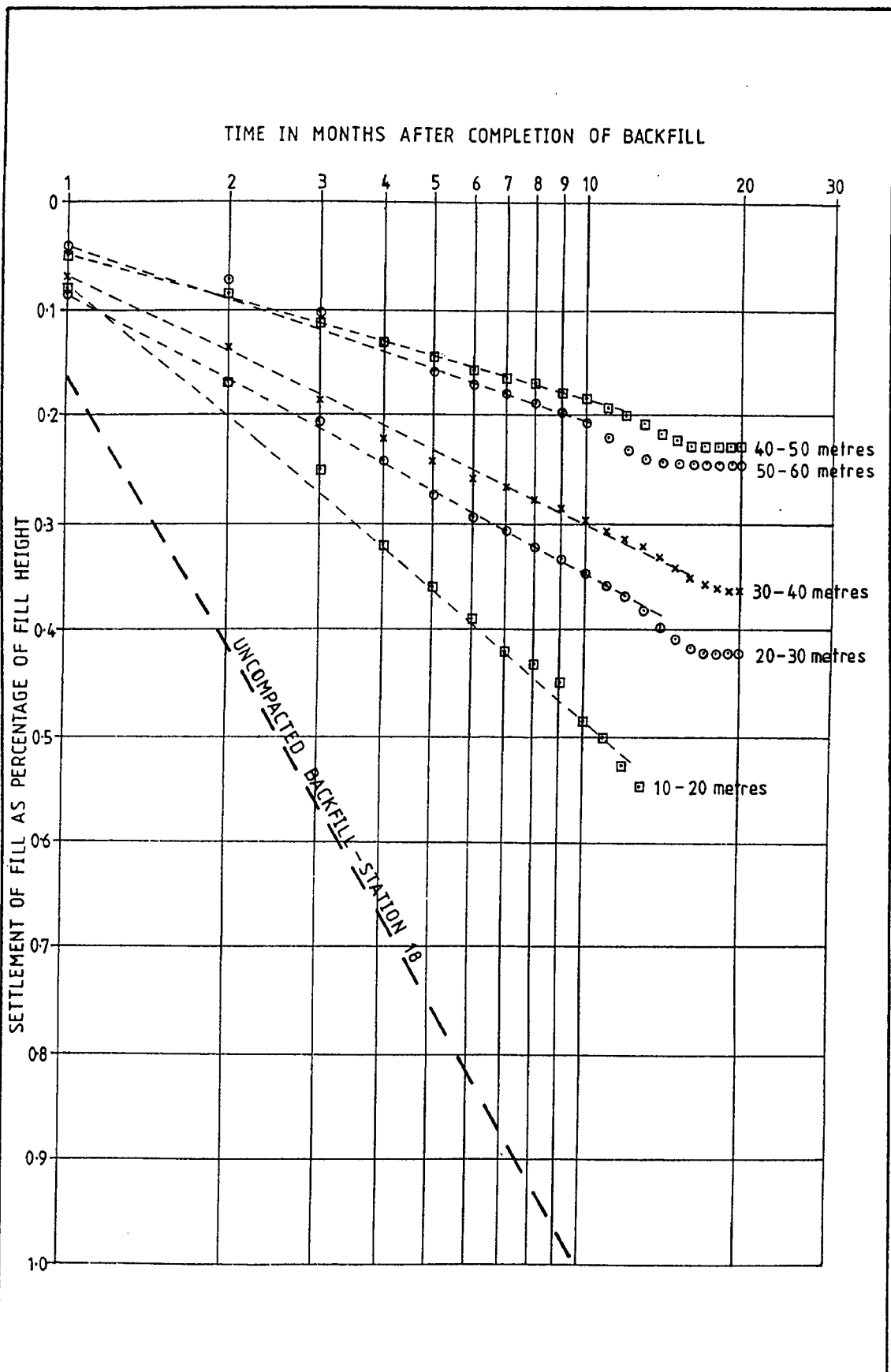

SETTLEMENT ( expressed as percentage of fill height )  
 AGAINST LOGARITHM OF TIME - for range of compacted  
 backfill thicknesses and uncompactied backfill. **FIGURE 5.2.24.**



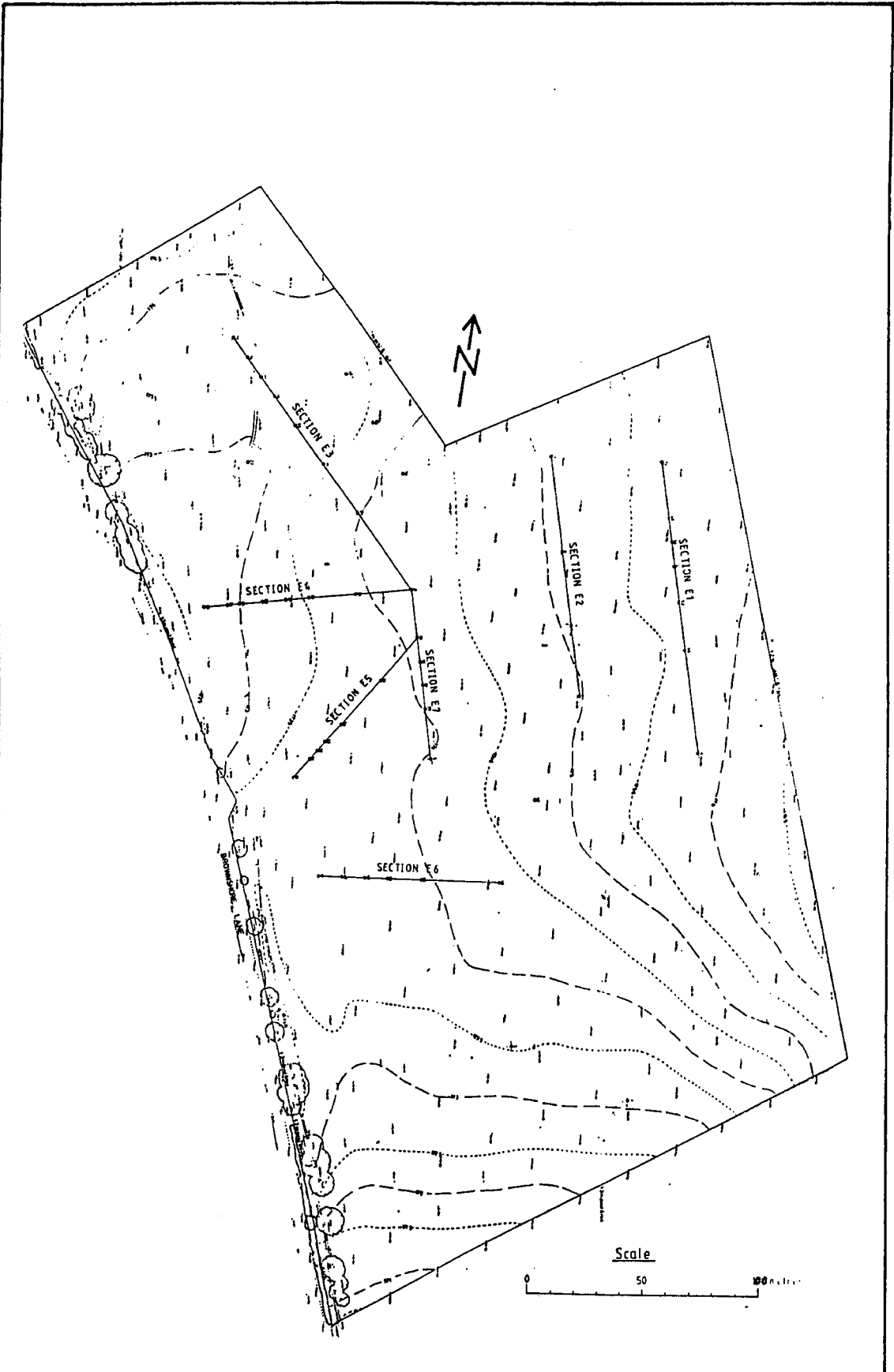

PLAN SHOWING SETTLEMENT SURVEY SECTIONS  
ESSINGTON.

FIGURE 5-2-25.

DATE (MONTH:YEAR)

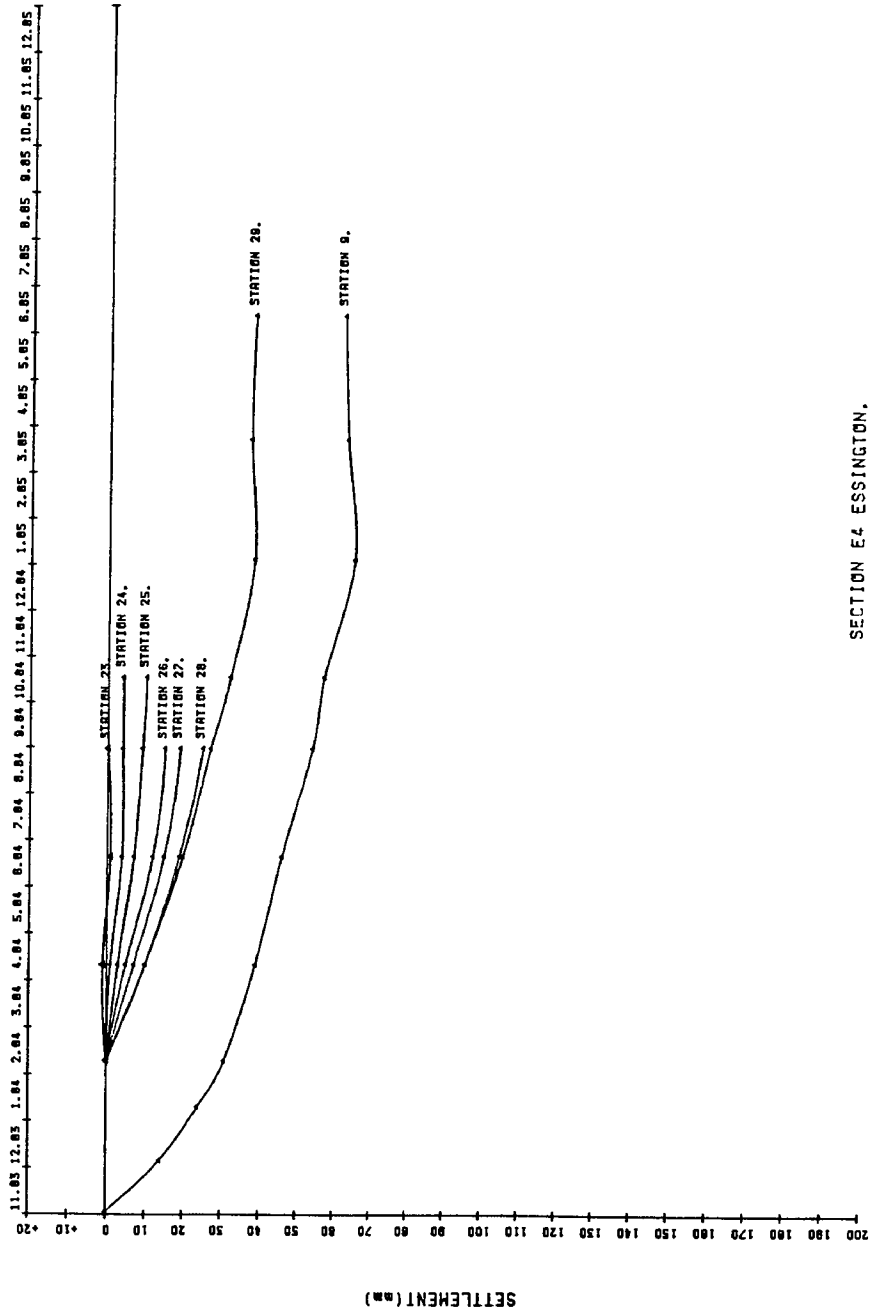

SECTION E4 ESSINGTON.

SETTLEMENT v TIME  
SECTION E4 ESSINGTON

FIGURE 5-2-26.

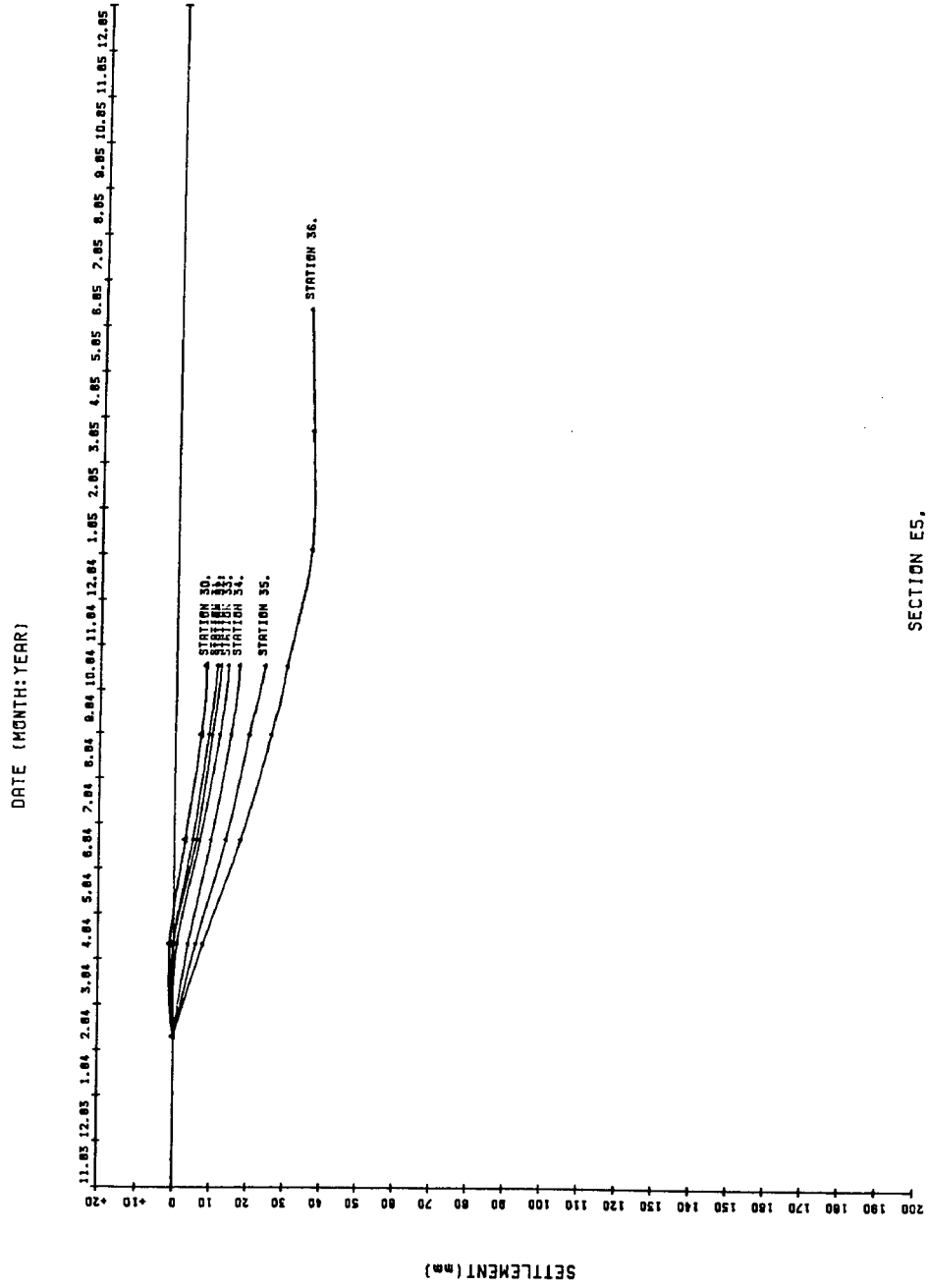

SECTION E5.

SETTLEMENT v TIME  
SECTION E5 ESSINGTON

FIGURE 5-27.

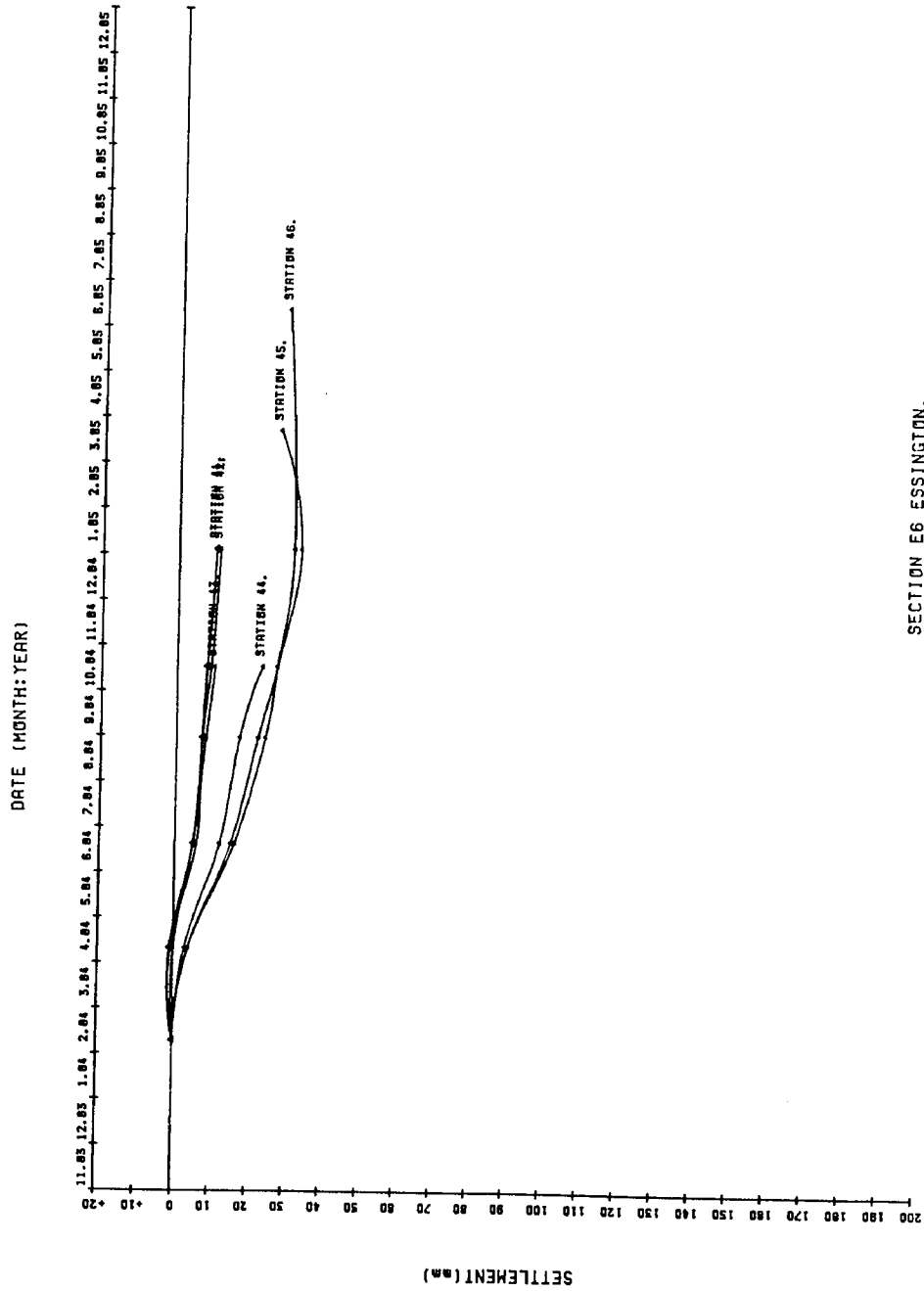

SECTION E6 ESSINGTON.

SETTLEMENT v TIME  
SECTION E6 ESSINGTON

FIGURE 5-2-28.

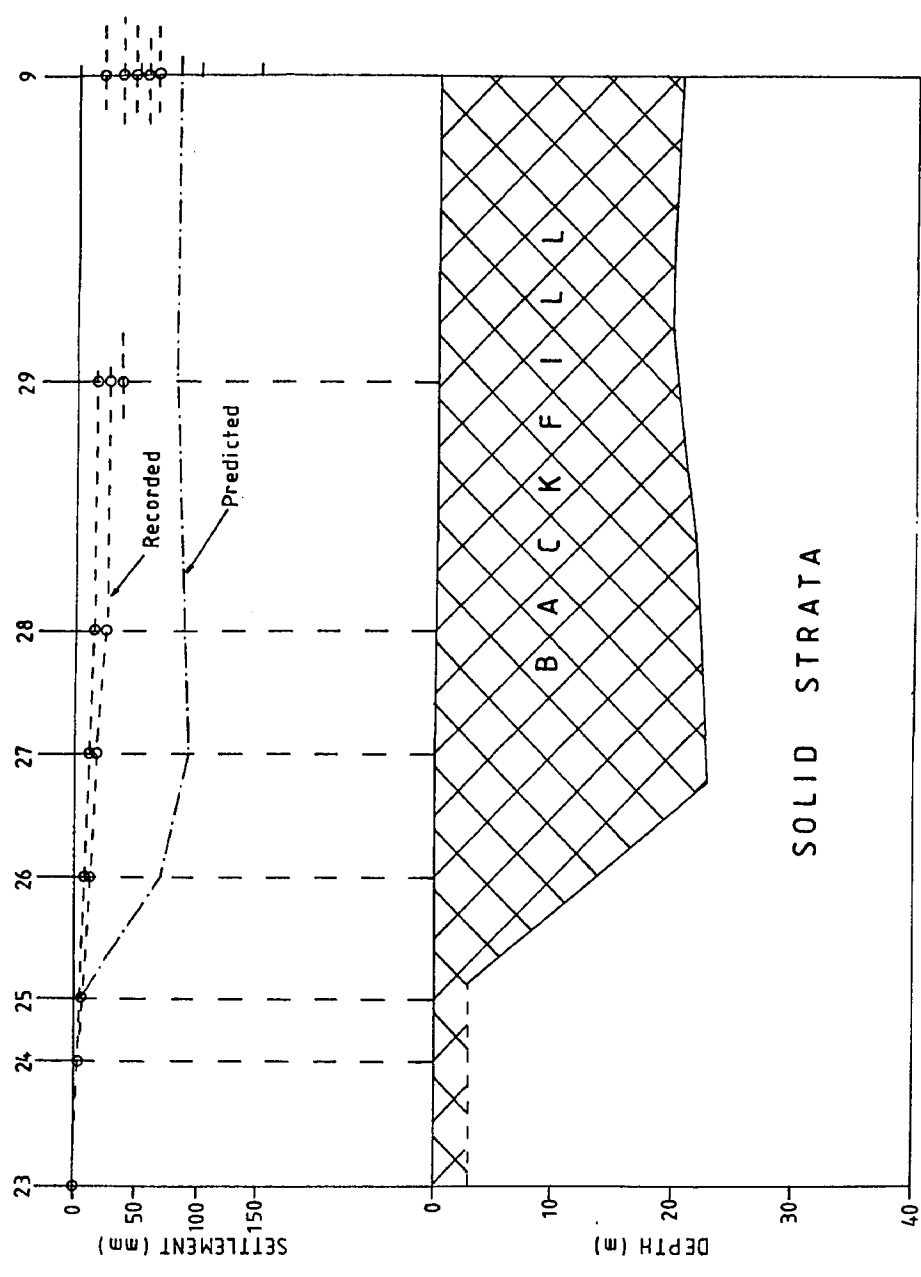

SECTION E4 ESSINGTON  
SETTLEMENT AND EXCAVATION PROFILES.

FIGURE 5-2-29.

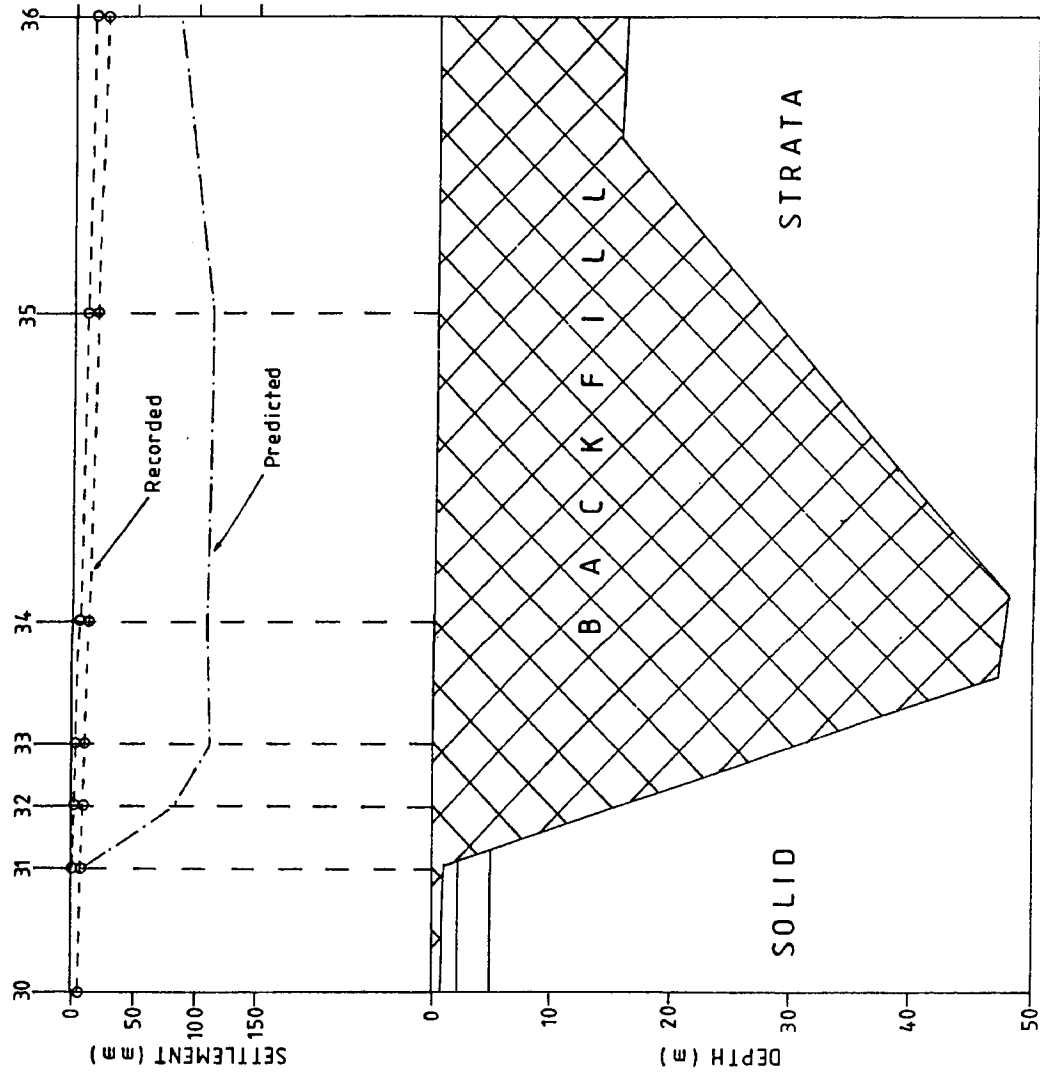

SECTION E5 ESSINGTON  
SETTLEMENT AND EXCAVATION PROFILES.

FIGURE 5-2-30.

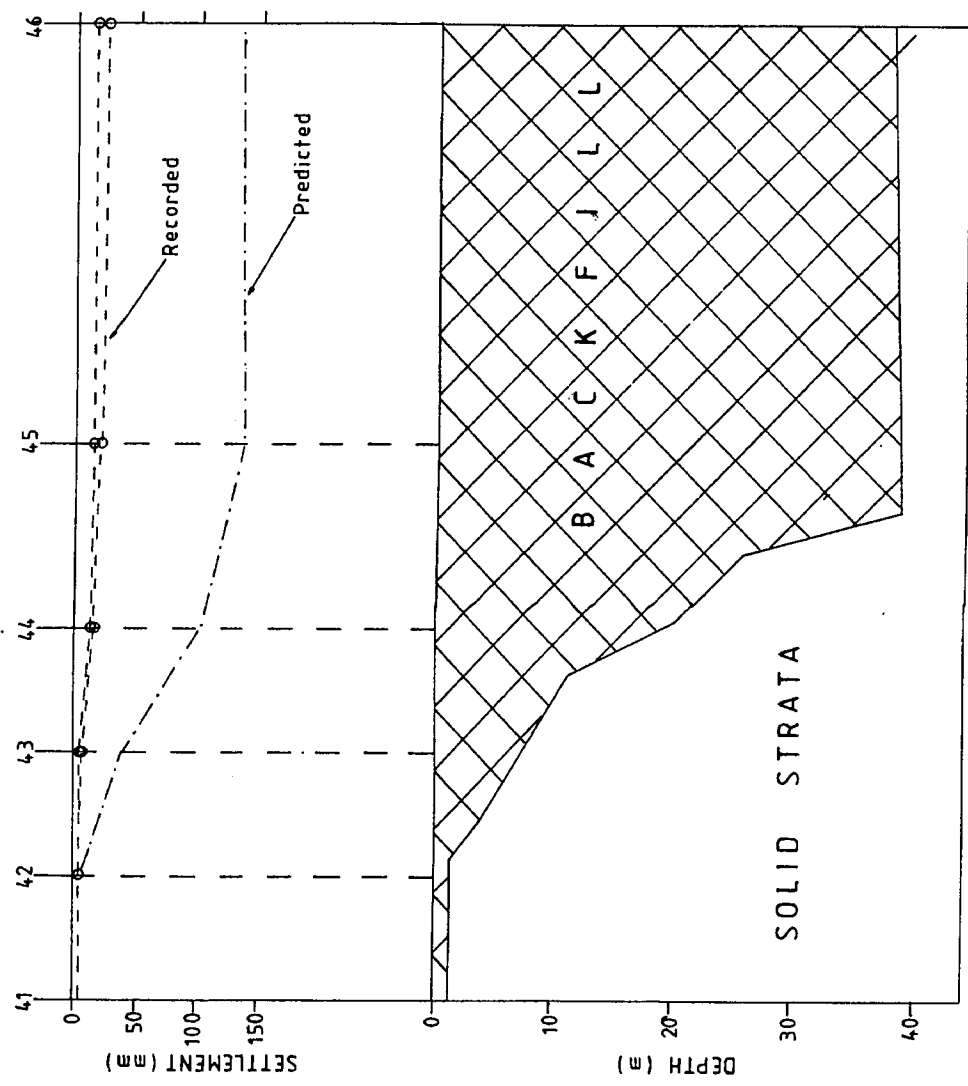

SECTION E6 ESSINGTON  
SETTLEMENT AND EXCAVATION PROFILES.

FIGURE 5-2-31.

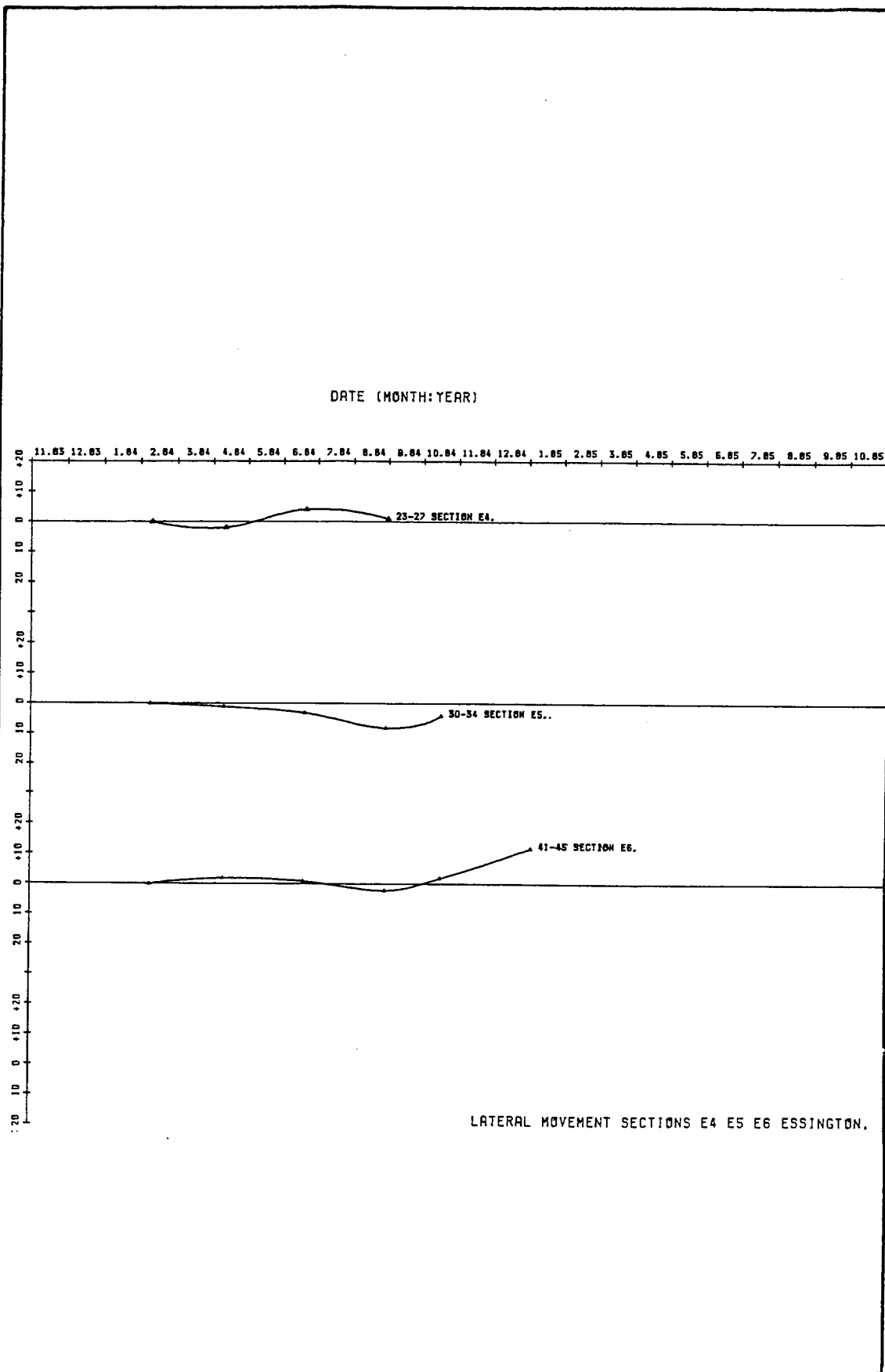

LATERAL DISPLACEMENTS  
SECTIONS E 4,5 & 6 ESSINGTON

FIGURE 5-2-32.



DATE (MONTH:YEAR)

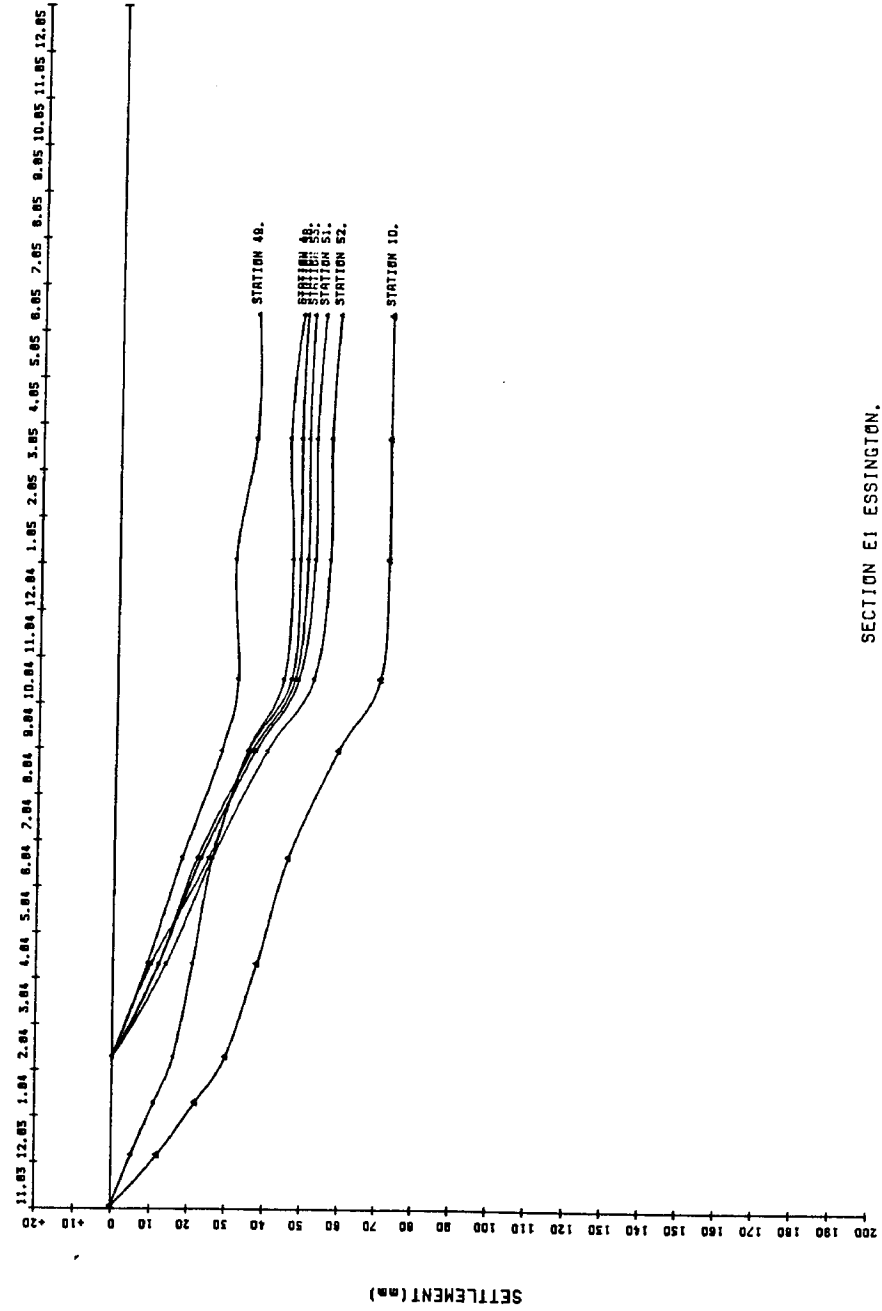

SECTION E1 ESSINGTON.

SETTLEMENT v TIME  
SECTION E1 ESSINGTON

FIGURE 5-2-33

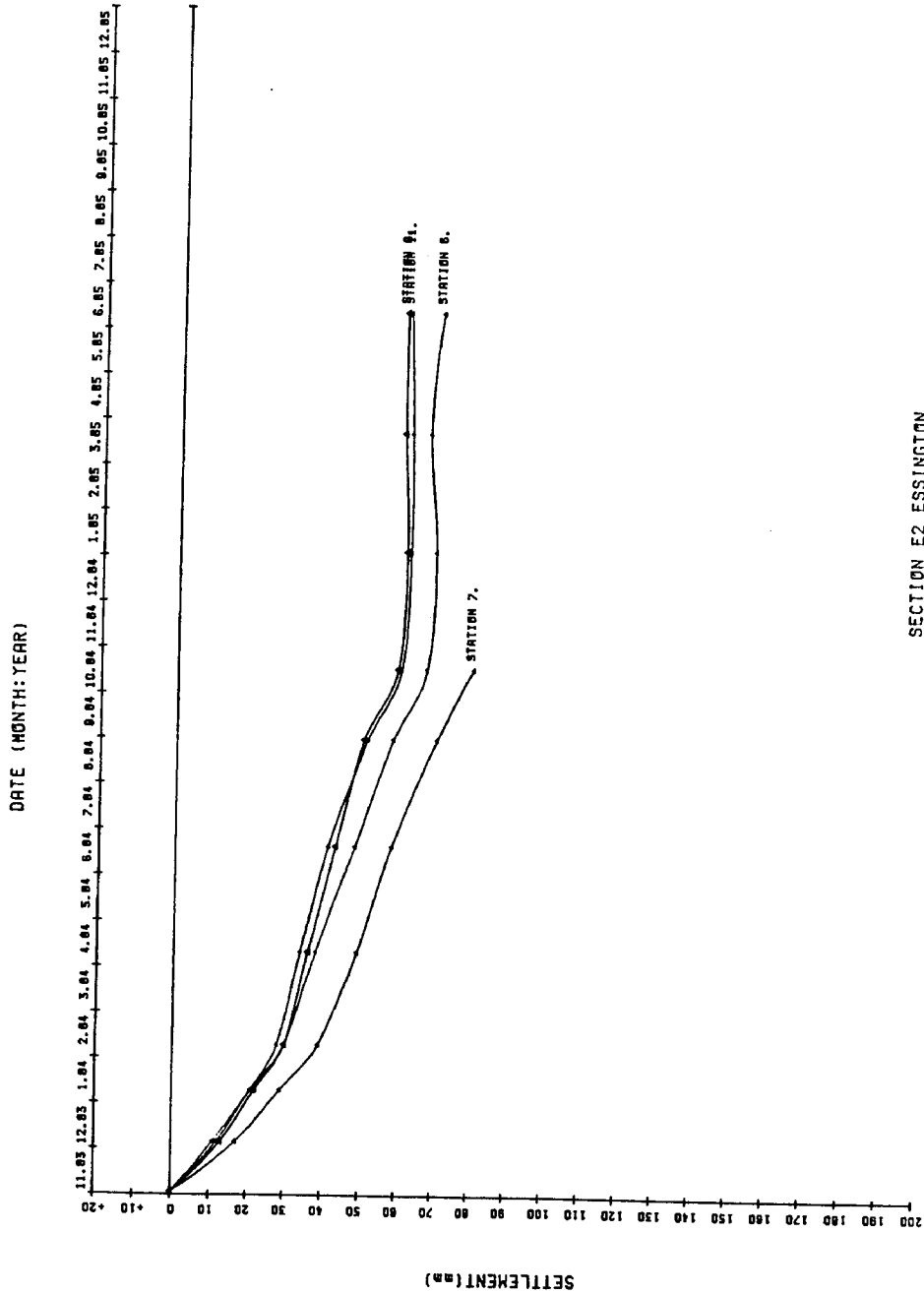

SECTION E2 ESSINGTON.

SETTLEMENT v TIME  
SECTION E2 ESSINGTON

FIGURE 5-2-34.

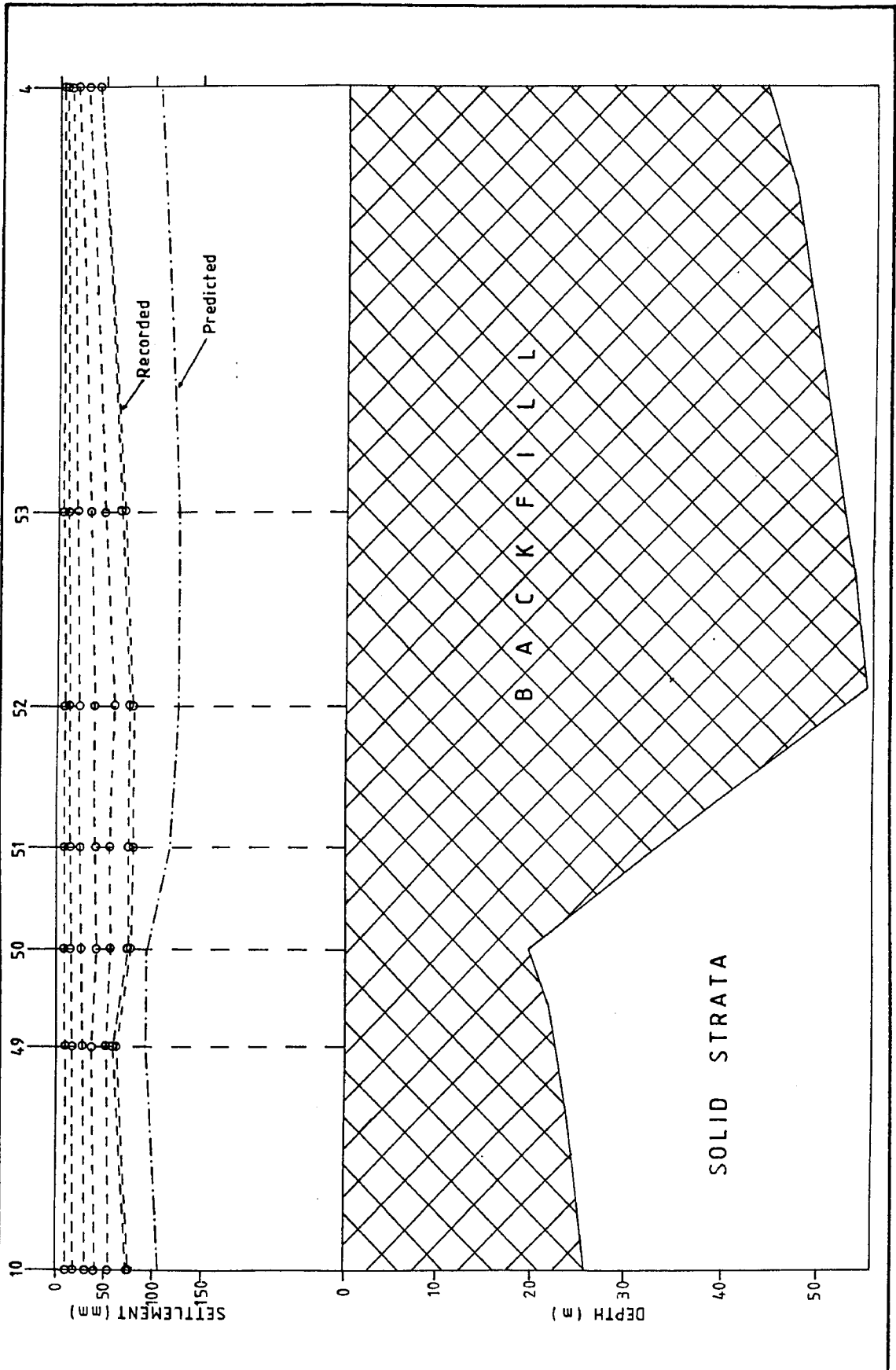

SECTION E1 ESSINGTON  
 SETTLEMENT AND EXCAVATION PROFILES.

FIGURE 5-2-35

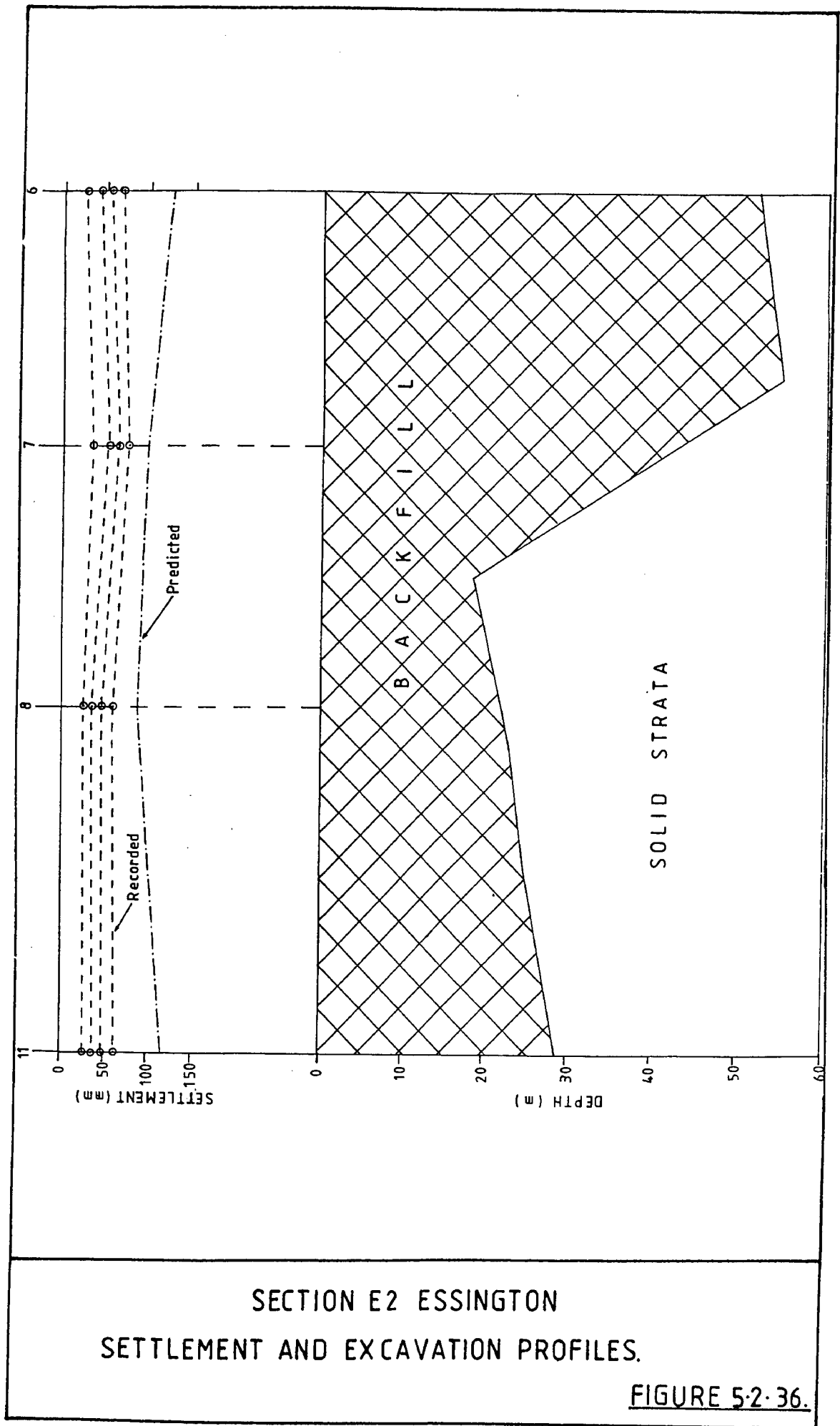

SECTION E2 ESSINGTON  
 SETTLEMENT AND EXCAVATION PROFILES.

FIGURE 5-2-36.

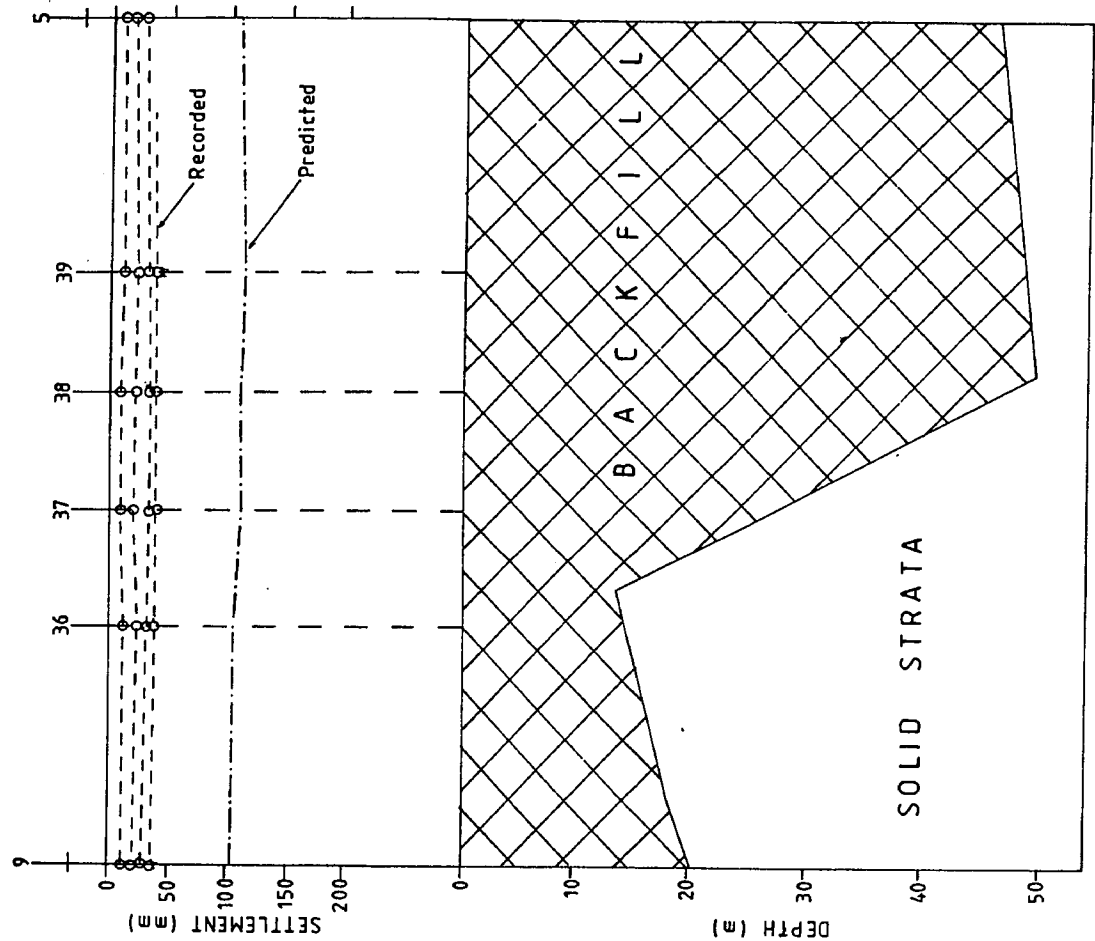

SECTION E7 ESSINGTON  
 SETTLEMENT AND EXCAVATION PROFILES.

FIGURE 5-2-37.

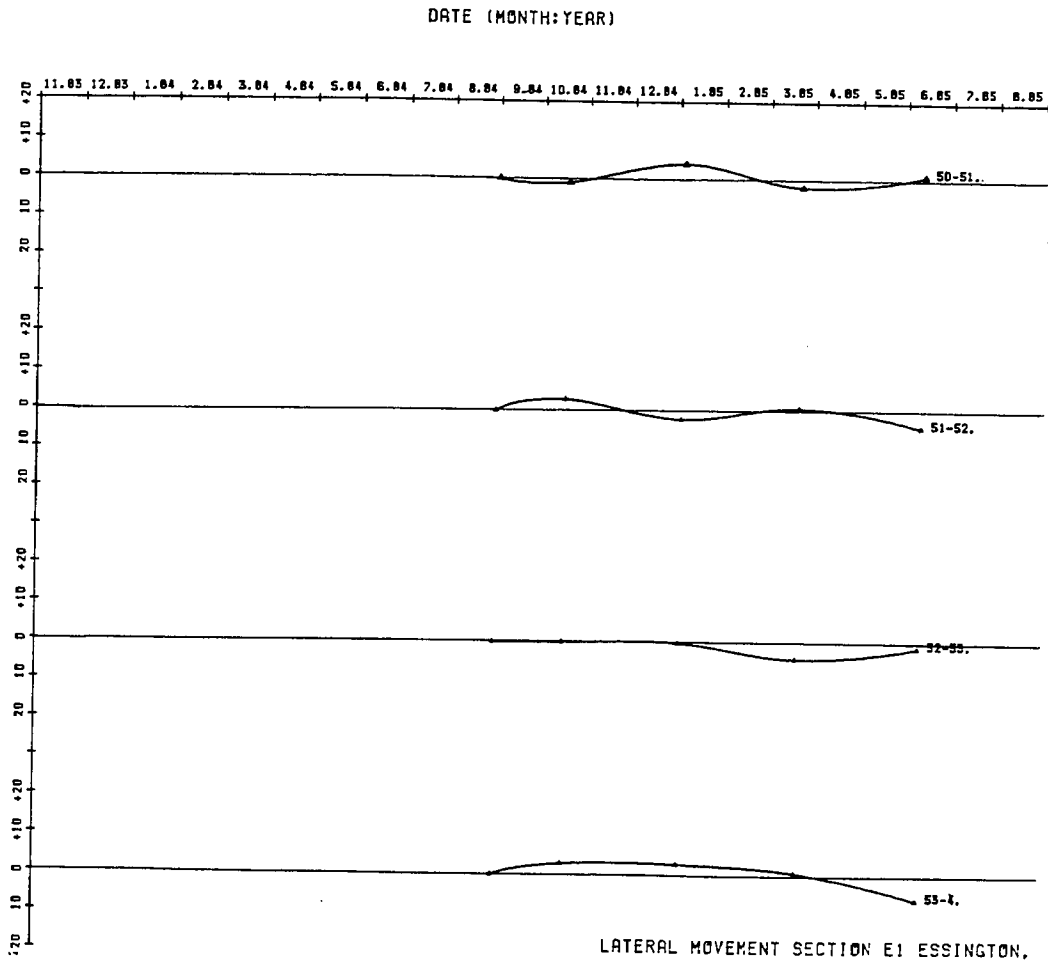

LATERAL DISPLACEMENTS  
SECTION E1- ESSINGTON

FIGURE 5-2-38.

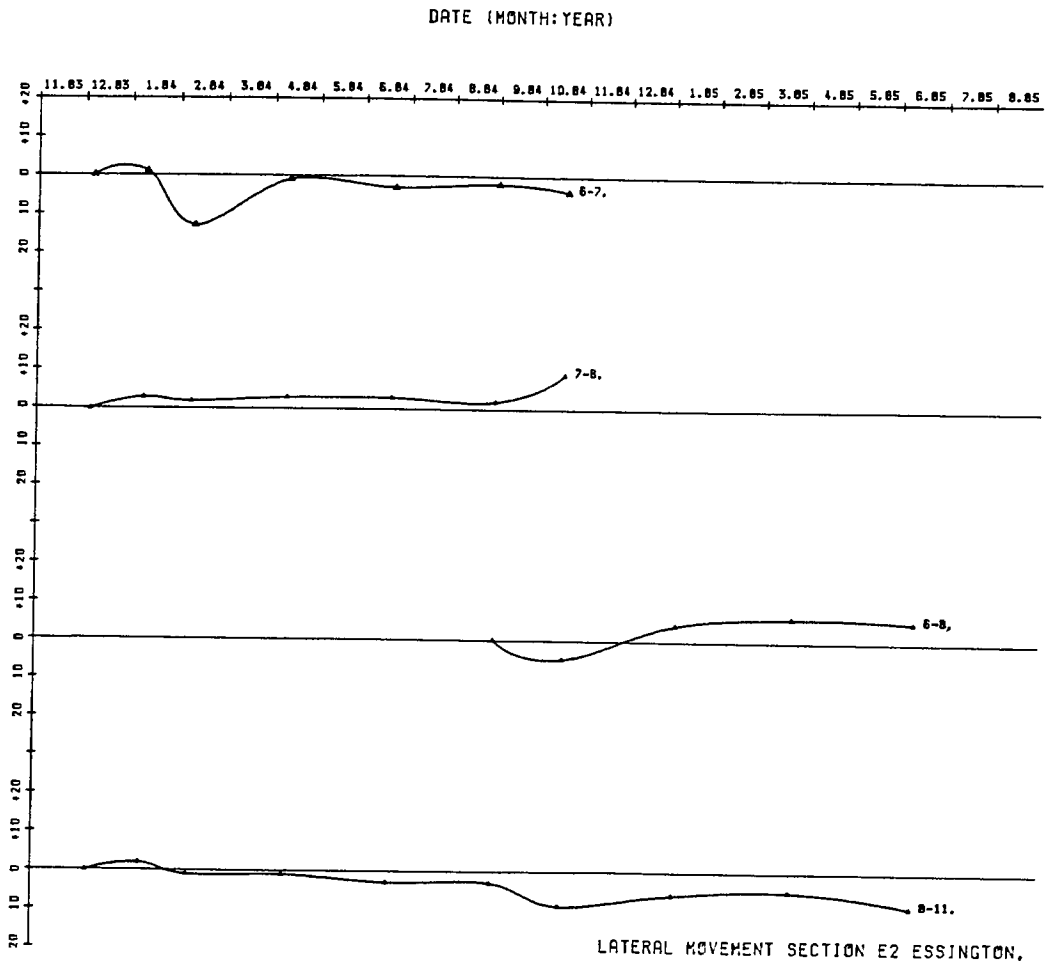

LATERAL DISPLACEMENTS  
SECTION E2 ESSINGTON

FIGURE 5-2-39.

DATE (MONTH:YEAR)

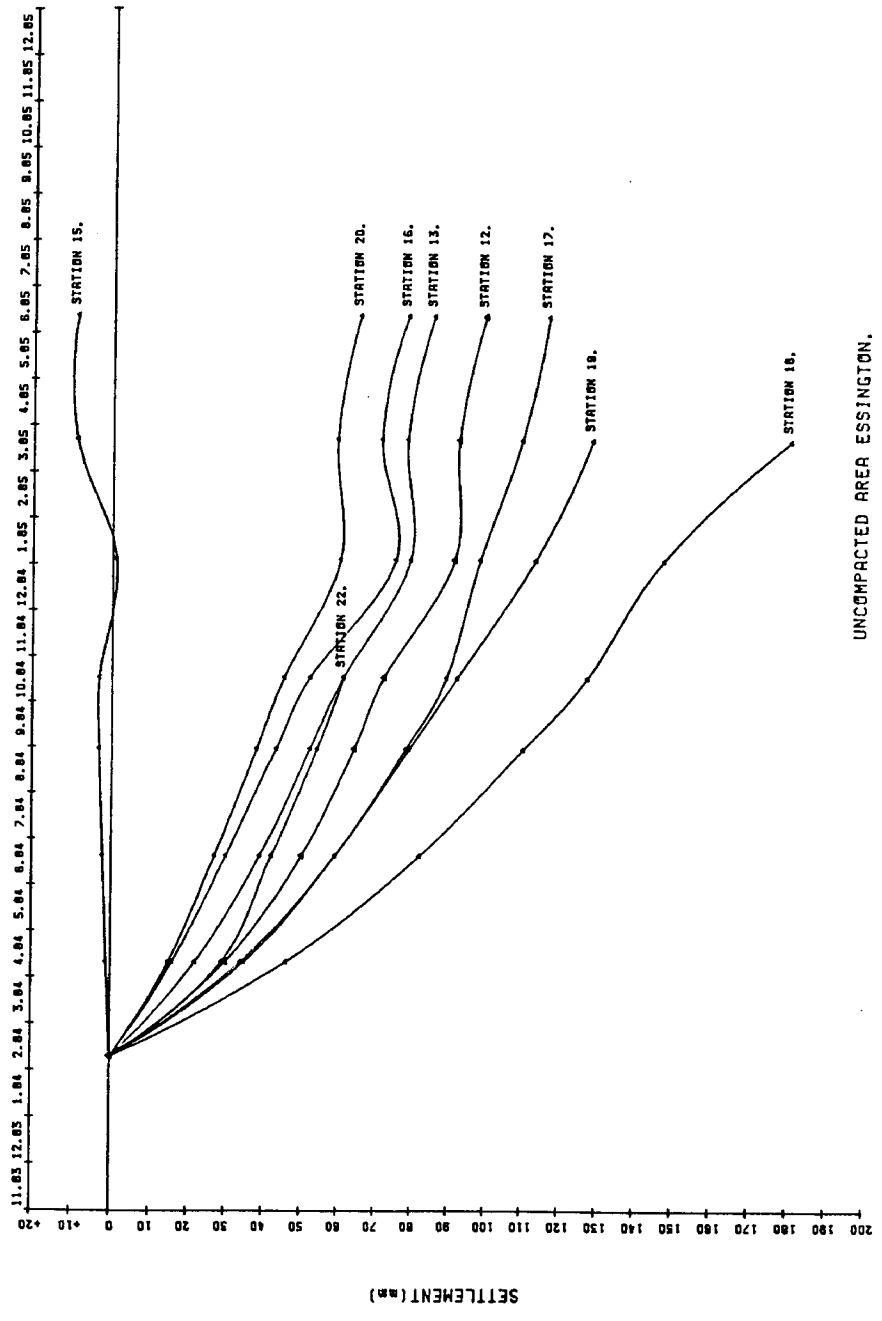

UNCOMPACTED AREA ESSINGTON.

SETTLEMENT v TIME  
UNCOMPACTED AREA, ESSINGTON.

FIGURE 5-2-40.



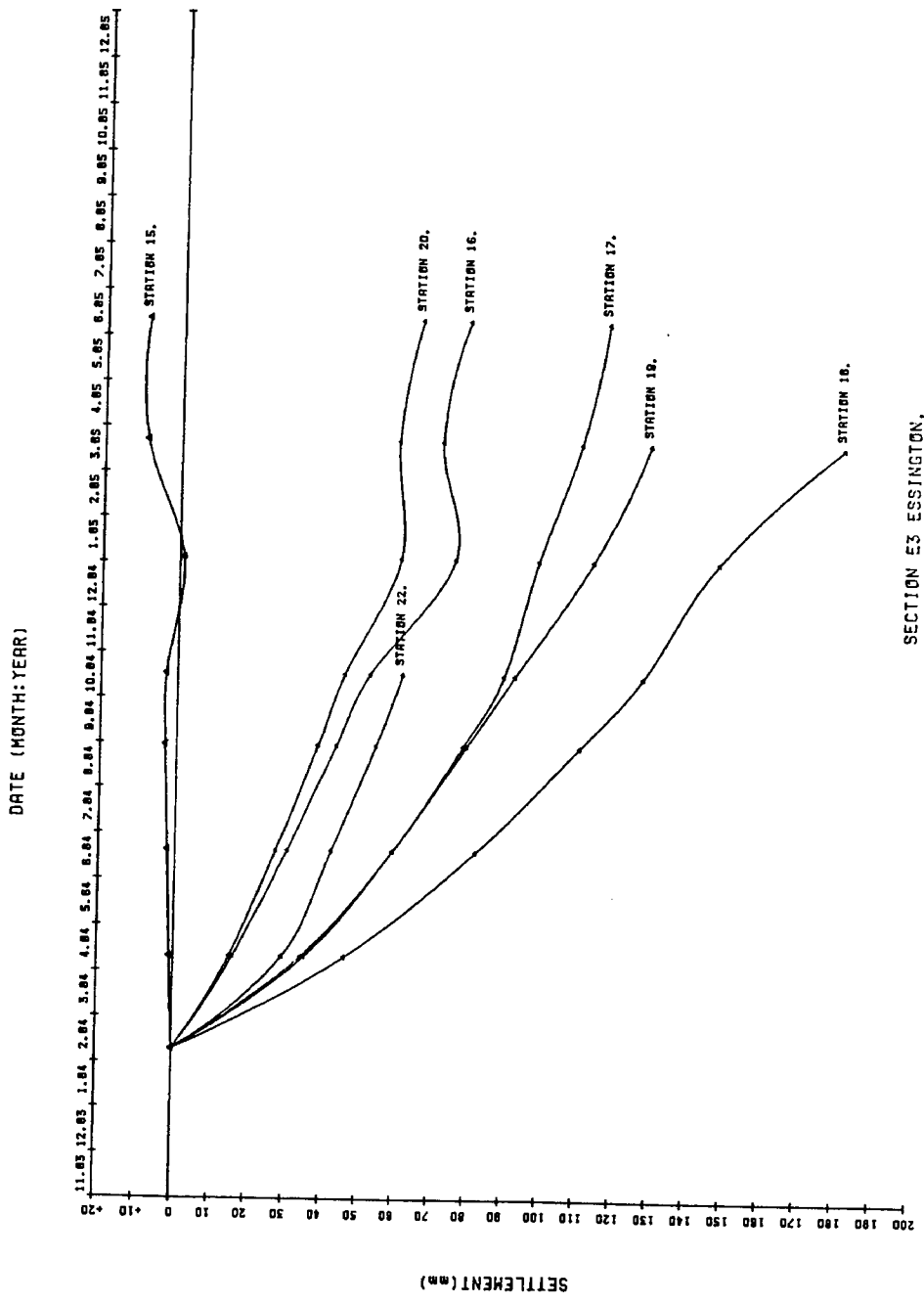

SECTION E3 ESSINGTON.

SETTLEMENT v TIME  
SECTION E3 ESSINGTON

FIGURE 5-2-41.

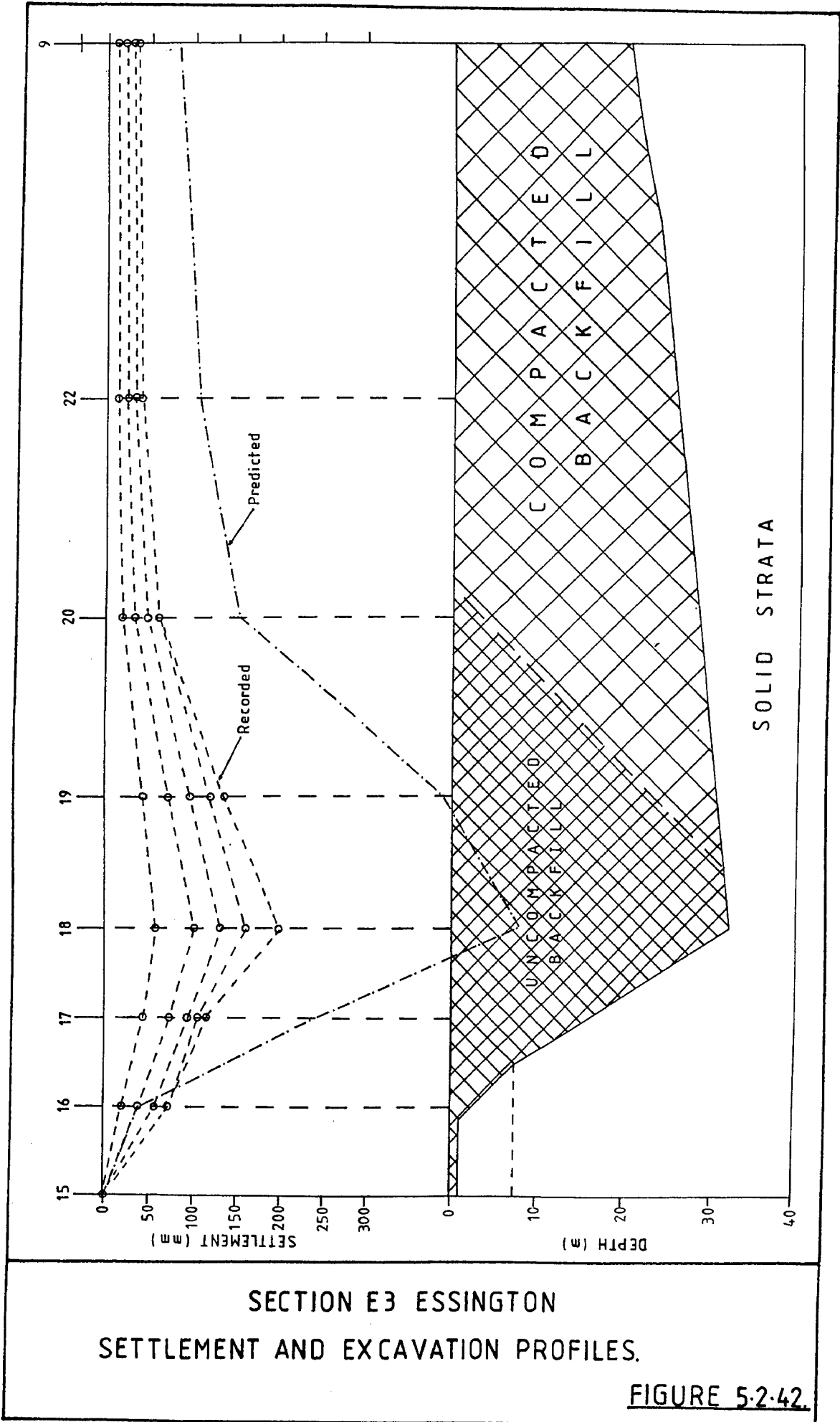

SECTION E3 ESSINGTON  
SETTLEMENT AND EXCAVATION PROFILES.

FIGURE 5-2-42.

DATE (MONTH:YEAR)

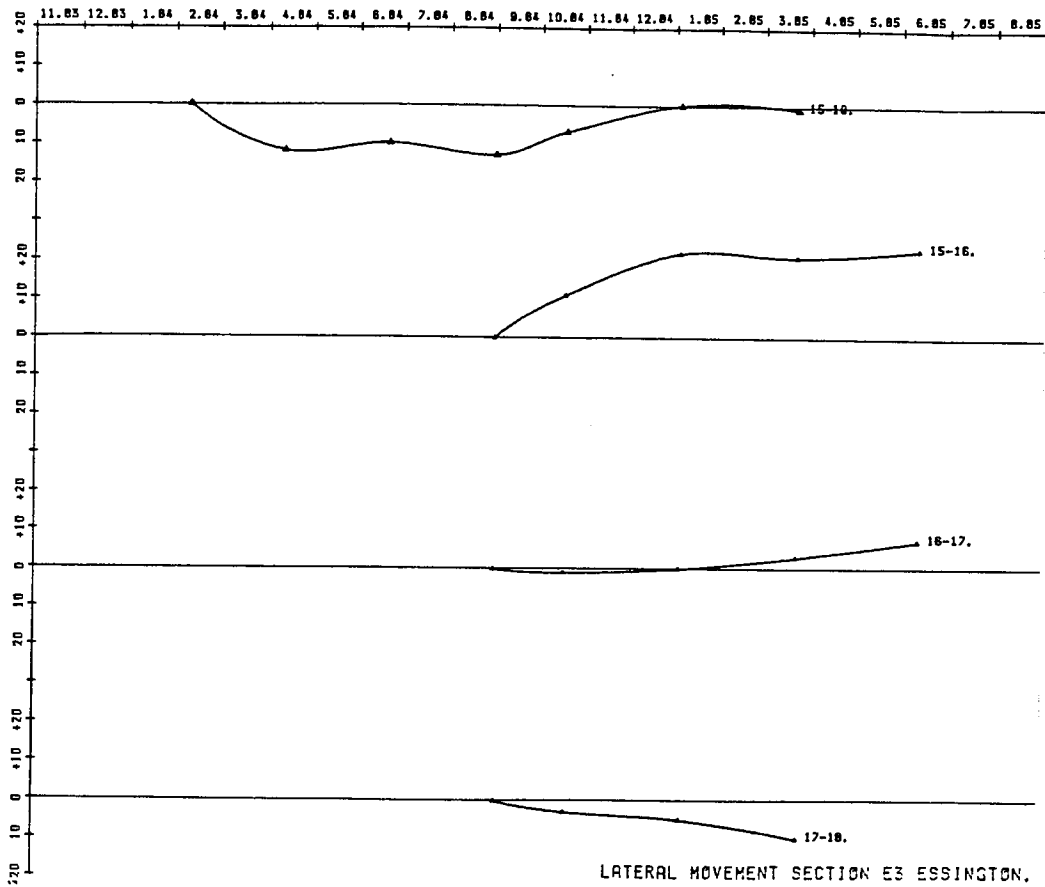

LATERAL DISPLACEMENTS  
SECTION E3-ESSINGTON

FIGURE 5-2-43.

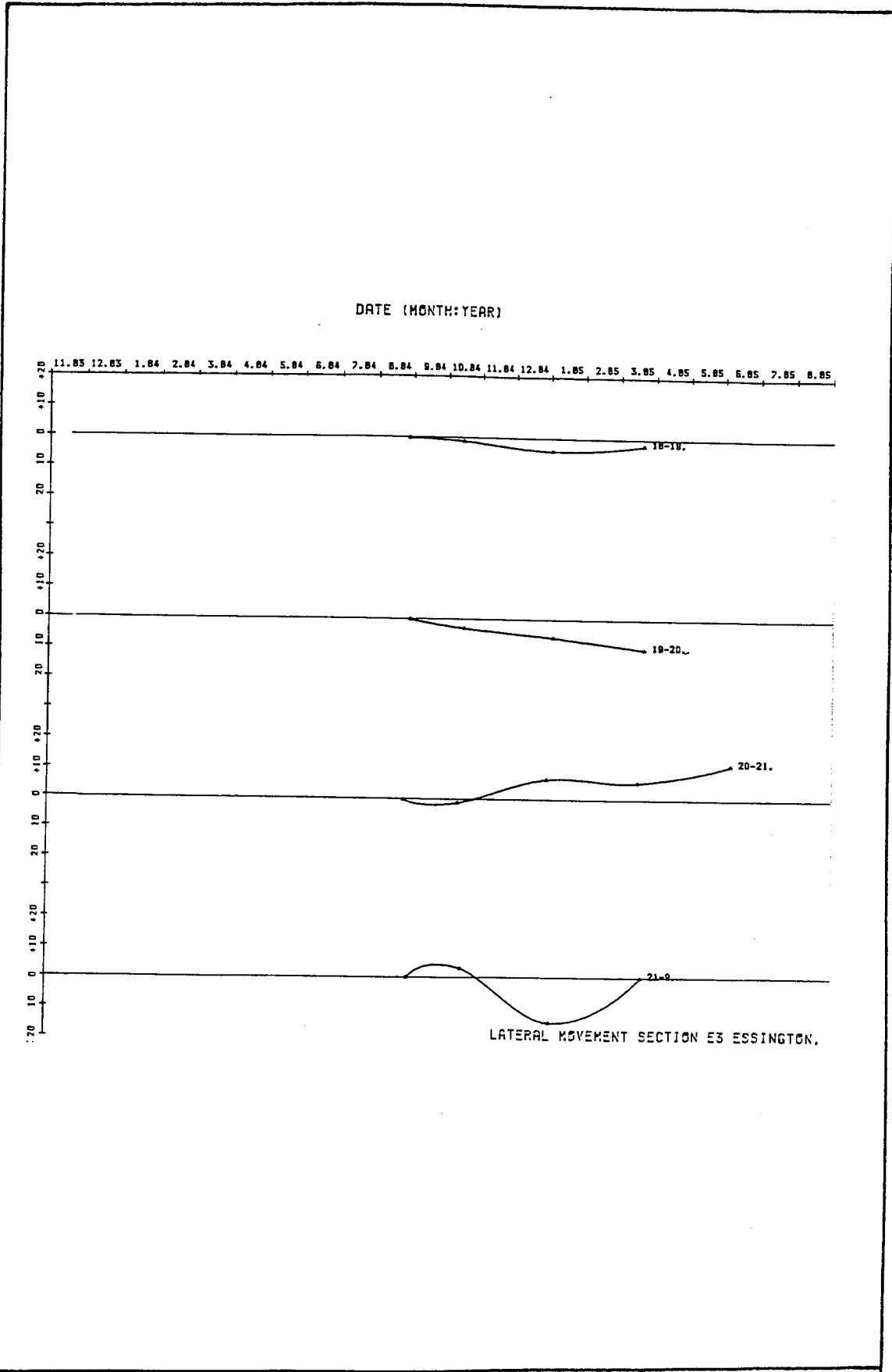

LATERAL MOVEMENT SECTION E3 ESSINGTON.

LATERAL DISPLACEMENTS  
SECTION E3 ESSINGTON

FIGURE 5-2-44.

### 5.3 HURST OPENCAST SITE, NETHERTON, WEST MIDLANDS

#### 5.3.1 Introduction

The Hurst opencast coal mining site is located in the Netherton area of Dudley, West Midlands, Figure 5.3.1. The site has been opencast mined in recent years, coal being won from three main coal seams, and restoration carried out in a controlled manner.

During the course of the backfilling operations, testing has been carried out not only to control the compaction of the fill, but also to examine its engineering characteristics.

On completion of backfilling, borehole and static cone penetrometer investigations were undertaken, borehole settlement gauges installed, and surface settlement stations established to monitor the settlement of the backfill with time. The results of this monitoring and testing are considered below.

#### 5.3.2 Location and Description

The site is located approximately two miles south of Dudley, West Midlands; National Grid REference SO 932 877.

The area is located in the Blackbrook Valley which forms part of the current Dudley Enterprise Zone. To the west and south are existing industrial premises, to the east is the Lodge Farm Housing Estate and the Dudley canal, and to the north is land proposed for industrial development which is currently grazing land. The area of the entire site is about 57 acres.

Prior to opencast mining the main (southern) body of the site consisted of poor quality grazing land with some random tipping and evidence of past underground mining activity. Spoil mounds, 'crown' holes (Plate 5.3.1) and evidence of abandoned mineshafts and adits (Plate 5.3.2) could clearly be seen.

The ground was generally undulating, with a higher ridge along the centre of the site (north-south), and a general fall to the east, towards the Blackbrook. North of the main body of the site an embankment, approximately ten metres high, ran east-west across the site; along the top was the former course of the Two Locks Line Canal. The top of the embankment was no more than about ten metres wide and had comparatively steep side slopes of 1 in 2.

North of the embankment the ground fell westward, from the Dudley canal, across more grazing land, to the Blackbrook. This northern area and the embankment had a heavy vegetation cover of trees and shrubs.

Since the completion of the current phase of opencast operations the majority of the site has been left as a series of level benches, the differences in level between adjacent benches being one to two metres (Plate 5.3.3).

Currently the northern portion of the site, north of (and including) the area of the former Two Locks Line, has been left incomplete pending a possible extension to the development (and opencast mining) northward. As a result, a basin shaped depression and spoil mound remain (Plate 5.3.4).

### 5.3.3 Geology

The available geological records, investigations and excavations have shown that the site is underlain by fill materials then weathered and intact rocks of the Middle (Productive) Coal Measures of the Carboniferous Period.

The fill is mainly located within the Two Locks Line embankment, which consists of mixed ash and clay. There are also areas of mine discard, a grey silty clay with rock fragments, in several areas within the main body of the site.

Beneath the fills are rocks of the Middle Coal Measures which consist essentially of bedded and alternating mudstones, siltstones and sandstones but with several important mineral seams of coal and fireclay at various vertical intervals (Figure 5.3.2). Close to the surface the rocks were frequently weathered to a stiff sandy clay with stone fragments, grading downwards to intact rock within a few metres.

The site is located on the western flank of the Netherton Anticline (Figures 5.3.3 and 5.3.4) whose long axis is orientated approximately north to south. The dip of the strata on the eastern edge of the site is indicated to be 18 degrees, decreasing westward to about 12 degrees at the western edge of the opencast area.

The Thick Coal and Heathen Coals outcrop along the eastern boundary of the site. From the Two Locks Line embankment northward, the outcrop of these seams swings round to the east, around the flanks of the Netherton Anticline (Figure 5.3.3).

Although not influenced by major faulting, a number of minor north-west to south-east trending faults are indicated by mine plans.

#### 5.3.4 Mining History

The site has a long history of mining, records of underground mining beneath the site date back to the 1870's but it is likely that some workings (particularly close to seam outcrop) are considerably older.

Underground mining continued in fireclay seams up until the early 1960's via adits located along the eastern edge of the site. From researches and site records there are believed to have been over 100 mine shafts and eight adits within the site (Figure 5.3.5) up to 60 of these shafts and five adits are located within the opencast area.

The Thick Coal, which is up to ten metres in unworked thickness, was the principal mineral seam to have been mined. Records indicate that it was worked on up to five occasions by underground methods. This would initially have been by the 'Pillar and Stall' system on two levels, a layer of coal being left between. Later workings 'Pickings' would have removed much of the remaining coal but not always in a systematic or uniform manner.

Other seams worked beneath the site (including the Lower Heathen Coal and New Mine Fireclays) were usually mined by the 'Total Extraction' system whereby they were removed along a broad face or wall, between roadways, no pillars being left as support to the roof.

A limited opencasting operation was undertaken along the outcrop of the Thick Coal in 1944 (Figure 5.3.3).



### 5.3.5 Opencast Mining Operations

The sequence of opencast mining operations was broadly similar to that at the Holly Bank site, Essington. The initial box cut was made at the southern end of the opencast area, the overburden being placed in temporary storage. The excavation was then progressively advanced from south to north and backfilling carried out in a number of stages once room was available to carry out this operation in conjunction with the removal of coal and overburden.

Due to the restricted room available and the elongate shape of the opencast area (Figure 5.3.6) it was necessary to provide a number of storage areas for the overburden. These were on the northern, eastern and western flanks of the excavation, and also in the central portion of the opencast area, once it had been backfilled. The last stage of backfilling was carried out using this stockpile material. In a long section (south-north) through the opencast area (Figure 5.3.7) the staged excavation and backfilling is shown together with the formation of overburden spoil mounds within the excavation area and along its northern edge.

For each 'box cut' the excavations commenced along the outcrop of the Thick and Heathen Coal seams and included the removal of backfill from old (1944) opencast workings along the outcrop of the Thick Coal (Figure 5.3.8).

Overburden was initially removed from above the Thick Coal horizon, revealing isolated 'pillars' of coal, coal slack and backfill within the seam horizon. The excavation of overburden was accomplished by initially

'ripping' the formation with either a Caterpillar D8H or D9L bulldozer (Plate 5.3.5), then the material was removed by Caterpillar 631D rubber-tyred motor scrapers.

The solid coal and coal slack material in the Thick Coal horizon was removed by a process of selective excavation or 'picking' using a Kamatzu D75S Tracscavator face shovel, coal materials and backfill subsequently being removed using Volvo dump trucks (Plate 5.3.6).

The overburden above the Upper and Lower Heathen Coals was removed in a similar manner to that above the Thick Coal. Since these coal seams were relatively thin and either unworked or had been entirely removed by underground mining, panels of coal could be exposed and removed in a systematic manner (Plate 5.3.7 and 5.3.8).

The floor of the excavation was typically the floor of the Lower Heathen Coal, the only exceptions being the isolated areas where excavation was difficult due to water ingress and in the northern-most 'box cut'. At the northern end of the opencast area care had to be taken to minimise loss of support to the eastern side slope, on top of which runs the Dudley Canal. As a result, the Heathen Coals were not removed in the northern-most 'box cut' and backfilling was carried out in a rapid and systematic manner following the excavation of the Thick Coal horizon.

The plan of total excavation (Figure 5.3.6) shows the shallow (five metre) step along the southern boundary of the northern-most 'box cut' resulting from the Heathen

Coals not being removed. The eastern boundary of the opencast area is normally the outcrop position of the Lower Heathen Coal, the dip of the strata is shown to dip westward initially at angles of 26 to 29 degrees but decreasing westward to 16 then 7 degrees in the deepest excavation area, i.e. decreasing away from the axis of the Netherton anticline. The depth of the excavation along its western edge was between 33 and 43 metres, usually closer to 40 metres. The highwalls along the northern, southern and western boundaries of the opencast area were ultimately trimmed to angles of between 64 and 72 degrees.

Once excavations were taken deeper than about 15 metres water ingress was encountered, this was often a rapid ingress through the worked Thick Coal horizon and in the broken rock above. On occasions when open mine roads (from old underground mining) were encountered a free flow of groundwater occurred (Plate 5.3.9 and 5.3.10). The volume of water inflow was sufficient to influence the ultimate extent of the opencast excavation and to necessitate pumping facilities to be maintained 24 hours a day, every day, until the completion of excavation. Two 6 inch pumps were used for this, which had a combined pumping capacity of 2,000 gallons per minute. This water was pumped to settling lagoons prior to discharge being allowed into the Blackbrook.

#### 5.3.6 Site Compaction and Controls

The backfill specification was based upon the Series 600 Earthworks Specification contained in the 1976 Department

of Transport 'Specification for Road and Bridgeworks'. Greater flexibility was, however, allowed where backfilling was being carried out at depths in excess of 15 metres below finished ground level, i.e:

- (a) Below 15 metres the specification allowed the backfill to be spread in layers not exceeding 500mm in thickness by rubber tyred motor scrapers, the passage of which was to be constantly varied to maximise compactive effort from the earthmoving plant. In addition, each layer was to be proof-rolled by a towed vibrating roller.
- (b) Above 15 metres the procedure was essentially the same as at greater depth, but the layer thickness was not to exceed 300mm and between three and four passes of towed vibrating rollers was required.

Due to the overburden pressures imposed below 15 metres, it was felt that a nominal decrease in the compactive effort should have no detrimental effect on the settlement performance of the fill. Indeed since this would allow a more rapid backfilling operation, more settlement could be expected to occur in these lower layers before completion, hence less settlement would take place following completion.

In the event, a layer thickness of about 300mm was adopted throughout since the motor scrapers could spread the backfill more evenly and more rapidly at this thickness. For compaction, a bulldozer was used to tow a single or pair of 6.3 tonne vibrating rollers (Bomag

BW6). Hence on many occasions a minimum of two and four passes of a vibrating roller was maintained below and above 15 metres depth, respectively.

In order to ensure that backfilling was carried out in relatively dry conditions, a rubble drain was constructed at the base of the western highwall. This drain fed water to a sump outside the backfill area from which it was pumped out of the excavation.

The progressive layering and compaction operations were carried out on at least two levels at any one time, this being in order to maintain a through flow of site traffic to and from the coal extraction area (Plate 5.3.11).

Each bench was 'keyed' into the weathered loose material on the exposed sloping face. A similar procedure was adopted to key the backfill into the highwalls. The main backfill benches are defined in Figure 5.3.9, general details of commencement and completion dates are presented in Figure 5.3.10.

As a further control on the compaction, Proctor compaction tests were carried out on samples of backfill from source areas (i.e. stockpiles), at commencement, and at suitable intervals during the backfilling (Figure 5.3.11). These results were compared against regular measurements of the in-situ density and moisture content using a nuclear density gauge (Figure 5.3.12) and sand replacement tests (Figure 5.3.13).

Overall, there tended to be good agreement between each of the above tests indicating that a high degree of compaction was being achieved. Variations were, however,

apparent and these are believed to be due to:

- (i) Minor variations in the degree of compaction being achieved, for example, between open areas and haul roads.
- (ii) Variations in the specific gravity of the material; values of between about 2.3 and 2.7 were recorded. The effect of this would be to draw the zero (and other) air void lines down into the cluster of results.
- (iii) The carbonaceous nature of the backfill would tend to cause a higher moisture reading on the nuclear gauge (Section 3.3). This is demonstrated when comparing the nuclear gauge results (Figure 5.3.12) with the sand replacement results (Figure 5.3.13). Areas tested by the nuclear gauge with an obvious carbonaceous content are plotted separately on Figure 5.3.14. There is cause to doubt the moisture reading recorded in these cases, which will in turn produce an abnormally low dry density reading.

Providing care is taken in the interpretation of the results there was good agreement in the above tests and they confirmed the high degree of compaction which was achieved.

#### 5.3.7 Monitoring and Testing

In order to establish and/or confirm the engineering and settlement characteristics of the backfill, a series of

tests were carried out and monitoring stations established. These consisted of the following:

- (a) Plate loading tests carried out on or close to the surface of backfill layers at variable levels using a 600mm diameter rigid plate; kentledge being provided by a laden motor scraper (Plate 5.3.12).
- (b) Cable percussive boreholes with Standard Penetration Tests (SPT's) being carried out at selected depths.
- (c) Static Cone Penetrometer probes continuously recording cone resistance and side friction to the base of the backfill.
- (d) Magnet extensometer systems placed in the cable percussive boreholes, spider magnets being set at selected depths in the backfill.
- (e) Surface settlement stations (pins) established on the completed benches, the greatest concentration being close to the highwalls.

The plate loading tests and the static cone penetrometer tests were carried as part of this research project rather than forming an integral part of the normal site controls.

The location of the static cone penetrometer probes (P1, P2 and P3), magnet extensometer systems (E1 and E2) and surface settlement stations (1-29) are shown in Figure 5.3.15. Additional surface settlement stations have been established in the more northerly part of this site but there is insufficient data for them to be considered in detail at this stage.

The results obtained from the testing and monitoring are presented below:

#### 5.3.7.1 Plate Loading Tests.

Following initial trials, loading increments of about 75 kN/m<sup>2</sup> were selected for these tests, the load and time increments being kept relatively constant for each test. The tests were continued for as long as was practicable, usually over a half or full day. The tabulated results for each of the tests are included in Appendix I.

In two of the tests (Nos. 5 and 8), out of a total of ten, the settlement readings were so small, even under high loadings, that they were meaningless. Subsequent excavation at these two test sites revealed the presence of large stone fragments buried close to the plate. For all other tests, the settlement readings have been plotted against time to give a series of consolidation curves (Figures 5.3.16 to 5.3.25). The end of 'immediate' settlement for each loading stage has been taken as the point at which settlement is less than 0.1mm over a five minute period. Plots of immediate settlement against pressure are presented in Figures 5.3.26 to 5.3.33.

In the six tests extended over several pressure increments (Nos. 3, 4, 6, 7, 9 and 10) an abrupt decrease in the rate of settlement was observed at pressures between about 210 and 420 kN/m<sup>2</sup>. This change in the settlement rate is believed to be the point at which large stone fragments within the backfill, and relatively close to the test plate, have an influence on the consolidation



performance of the backfill in the response zone.

Calculations considered below are based on the initial settlement/pressure profile believed to be associated with the matrix of the backfill.

Since the ultimate pressure was not reached in the tests, the assumption has been made that the pressure-settlement curve is of the exponential type and a simple geometrical extrapolation can be used to determine  $q_{ult}$  (Wilun and Starzewski, 1975), as demonstrated in Figure 5.3.28.

Based on this procedure, the ultimate pressures determined from the results ranged between 170 and 500 kN/m<sup>2</sup>, with a mean of 387 kN/m<sup>2</sup>. Considering only those tests undertaken relatively close to the finished ground level (within about ten metres), the range is between 360 and 500 kN/m<sup>2</sup>, with a mean of 414 kN/m<sup>2</sup>. From these values, adopting a factor of safety of 3, a net allowable bearing pressure of at least 120 kN/m<sup>2</sup> could be suggested.

The final (consolidation) settlement curve can be used in the evaluation of the deformation modulus  $E_v$  (Wilun and Starzewski, 1975). The final settlement curve can be plotted using ordinates evaluated from the following expression:

$$S_{cj} = S_i + \Delta S_i + \frac{S_i q_j}{S_n q_n} \Delta S_n$$

where  $S_{cj}$  = final settlement at loading intensity  $q_j$

$S_i$  = immediate settlement at loading intensity  $q_j$

$S_n$  = immediate settlement at final loading intensity  $q_n$

$\Delta S_n$  = increase in settlement during the last loading stage from the moment when the rate of settlement is equal to 0.1mm in 5 minutes until the end of primary consolidation stage (rate of increase 0.1mm in 2 hours).

Calculations based on the above have shown that the final settlement curves are for all practical purposes, the same as the immediate settlement curves. Consider, for example, test No. 7:

$q_i$	$S_i$	$\Delta S_i$	$S_{ci}$
0	0	0	0
100	1.0	0	1.0
200	3.2	0.04	3.24
300	5.8	0.10	5.90
400	10.3	0.25	10.55

$$\text{for } q_n = 422 \text{ kN/m}^2$$

$$S_n = 11.8\text{mm}$$

$$\Delta S_n = 0.3\text{mm}$$

The deformation modulus for the soil in a given layer can be determined from the following expression:

$$E_v = B (1 - \nu^2) \omega \text{ or } \frac{\Delta q}{\Delta s}$$

where  $\omega$  or = coefficient corresponding to the shape of the plate: for a rigid circular plate  
 $\omega$  or = 0.79.

B = diameter of the plate.

- $\Delta q$  = increase in loading.  
 $\Delta s$  = increase in settlement due to  $\Delta q$ .  
 $\nu$  = Poisson's ratio.

Using a Poisson's ratio of 0.3 (for a mixed soil material) the calculated values of  $E_v$  are plotted against increase in pressure, for each test in Figure 5.3.34, together with a mean line plot. These results indicated that  $E_v$  decreases with increasing pressure from about 40 to 15 MN/m<sup>2</sup> in the pressure range 0 to 400 kN/m<sup>2</sup>. It could be suggested that the values of  $E_v$  determined in the above are representative of the stiffness properties of the backfill; hence that they could be used in the finite element analysis described in Section 6. However, rather than the decrease in  $E_v$ , with increasing pressure exhibited in the plate tests, the backfill would be expected to become stiffer with increasing pressure (i.e. depth). This difference is believed to be due to comparing tests which are carried out on the surface, where the surrounding surface is not subjected to any surcharge, and at depth in the backfill where the entire layer of backfill being considered is subject to overburden pressure, i.e. is confined. On this basis the  $E_v$  values suggested at low pressure may be representative of the near surface backfill, but the results become increasingly inaccurate with increasing depth/pressure.

#### 5.3.7.2 Penetrometer Testing

Details of the Standard Penetration tests carried out in the two cable percussive boreholes are included in the

borehole logs (Figures 5.3.35 to 5.3.40). The 'N' values have been plotted against depth in Figure 5.3.41, with the exception of the test at 12.0 metres in Borehole E1 where a sandstone boulder was struck during the test.

The 'N' values ranged between 13 and 35 with a mean of 20. Although this test is primarily intended as a method for determining the density of sands, these results would infer that the backfill is in a medium dense/firm state throughout. At least some of the variations in the 'N' values will be due to variations within the material itself. For example, lower 'N' values could be expected to matrix (cohesive) dominant backfill as compared with tests carried out within backfill with a higher proportion of rock fragments.

Three static cone penetrometer probes were carried out by Fugro using their 18 tonne truck mounted penetrometer. The cone (Figure 5.3.42) was pushed into the ground by the hydraulic jacking system of the penetrometer, measurements constantly being taken of cone tip resistance and local side friction. Plots of side friction ( $f$ ), cone resistance ( $q_c$ ) and friction ratio ( $F/q_c \times 100\%$ ) are presented in Figures 5.3.43 to 5.3.45. The influence of stone fragments within the backfill is even more pronounced in this continuous testing than in the SPT tests, the values within a very short distance being highly variable. In order to make the results more readable, block diagrams have been produced for each of the tests using average values over 0.30 metre depth increments (Figures 5.3.46 to 5.3.48)

Schmertmann (1969) has shown that the soil type is a function of cone end resistance and friction ratio (Figure 5.3.49). On this basis the backfill materials are broadly defined as sandy clays, although the presence of a significant proportion of rock fragments is evident by the fluctuations seen in the readings.

Many studies have been carried out to correlate cone resistance ( $q_c$ ) with Standard Penetration tests (N-value). It has been recognised that the particle size distribution has an important influence on the correlation. The generally accepted conversion factors are those derived by Schmertmann (1970) which are presented in Figure 5.3.50.

Comparing then, the SPT N-values detailed above the cone end resistance in these probes, mean values have been determined:

<u>Probe No.</u>	<u>Mean Cone End Resistance</u> (kgf/cm <sup>2</sup> )	<u>Comments</u>
1	64	No trend with depth.
2	42	Appears to decrease below about 15m. (Mean above 15m = 49. Mean below 15m = 35).
3	48	No trend with depth.

Since the mean 'N' value is 20 this would imply that a correlation factor of between 2 and 3 should be applied for backfill materials. In Schmertmann's table (Figure 5.3.50) this would compare with a natural cohesive sandy material.

### 5.3.7.3 Settlement Observations

The settlement observations are based on results from monitoring carried out at the surface of completed backfill areas, and magnet extensometer systems established to determine what settlement occurs at depth within the fill. Since the methods of backfilling, and the materials themselves, are similar at Essington and the Hurst it should be possible to compare the two, and adopt similar procedures for analysis.

- (i) Surface settlement - plots of settlement against time are presented in Figures 5.3.51 to 5.3.54, for the surface settlement stations considered.

It is clear that in all cases the rate of settlement decreases with time, also that settlement effectively ceases after about 18 months (following completion of restoration). In addition, although observation points within and close to the backfilled areas indicate that the water table has virtually recovered during this period, there is no evidence of a change in the rate or magnitude of settlement being recorded at the stations.

Because of the highly variable thicknesses of fill beneath each station and the limited number of stations available, the pattern of settlement within the main backfill areas is not considered. Rather, the stations have been compared on the basis of the fill thickness at each location. This has been carried out by plotting logarithms of time since completion of backfilling against settlement of fill expressed as a percentage of the fill height. Further to this, since monitoring results are not available for the first month, and since the magnitude of

the settlement which occurs in this month can only be estimated approximately, the settlement has been taken to commence at month one. All of the results have been plotted on Figure 5.3.55 where a linear relationship is established, but the magnitude varies considerably. The results have therefore been divided into ten metre fill thickness categories and mean values established (Figures 5.3.56 to 5.3.59). Comparing these mean values (Figure 5.3.60) it is evident that once again the settlement (expressed as a percentage of fill height) decreases with increasing thickness of backfill. This may be summarised as follows:

<u>Fill Thickness Range</u> (m)	<u>Settlement Expressed as a</u> <u>Percentage of Fill Thickness (%)</u>
Less than 10	0.51
10-20	0.32
20-30	0.29
30-40	0.27

Use has been made of the above in considering sections of backfill alongside the main western highwall. Five section lines have been considered (H1 - H5), the profiles for which have been derived from the monthly survey information (Figures 5.3.61 to 5.3.65), their locations are shown in Figure 5.3.15. Included on these sections are the locations of the surface settlement stations, the settlements recorded at approximately three monthly intervals and a predicted settlement line based on the above estimates of settlement expressed as a percentage of fill thickness.

Considering a limiting differential settlement equal to a maximum allowable angular distortion of  $1/500$ , the zone which may need to be 'sterilised' for development until completion of settlement (about 18 months) can be defined. In each case, the 'sterilised' zone would be approximately equal to the horizontal distance between the surface and basal limits of the highwall, i.e. between about 16 and 52 metres along these sections. On this basis, the zone above steep highwalls would be narrow and the magnitude of differential settlement would be high, whereas over a gently inclined highwall the zone would be wide but the magnitude of differential settlement would be far less.

- (ii) Settlement at depth in the backfill - plots of settlement measured at different depths within the fill at extensometer installations E1 and E2 are shown on Figures 5.3.66 and 5.3.67. In these plots the settlement trend is very similar to that exhibited at the surface stations and the magnitude of settlement decreases with time. This is perhaps better demonstrated in Figures 5.3.68 and 5.3.69 where settlement is plotted against depth at approximately three monthly intervals.

The pattern of movement exhibited by E1 tends to be relatively consistent with a steady increase in total settlement at each depth with time, the magnitude decreasing with depth. However, the variation in total settlement with depth is not great, the maximum between the surface and a depth of about 22.2 metres being 26mm. From this it is evident that the magnitude of vertical compression must be far greater with depth. This



relationship is examined by plotting vertical compression beneath each magnet (expressed as a percentage of the fill thickness beneath the magnet) against depth of burial, Figure 5.3.70. The initial (shallow depth) increase in vertical compression can be expected due to increasing overburden pressure, this would, however, not on its own explain the sharp rise in vertical compression below about 15 metres depth. Since this depth coincides with both a change in the backfilling standard and the standing water level either could be the cause of this increase.

However, the records of backfilling in this area and the static cone penetrometer (P1) indicate that there is little (if any) variation in the compactive effort actually applied at each depth therefore it would seem that a proportion of the vertical compression below 15 metres is due to saturation of the backfill.

The pattern of settlement is somewhat more complex in E2. Initially the magnitude of movement at the surface is far greater than at any other depth, thereafter the magnitude of settlement tends to be approximately the same at each level. More recently the magnets at 20 and 24 metres have been showing less settlement than previously, i.e. indicating that there has been some heave. The higher initial settlement at the surface may be explained by the fact that the last few metres of backfill were placed some months after the rest. The fluctuations at depth in the backfill are believed to be due to the magnets not being fully anchored in the sides of the borehole, hence they are not giving representative readings.

#### 5.3.7.4 Summary of Monitoring and Testing Information.

From the three main forms of testing and monitoring carried out at this site the following conclusions may be drawn:

##### Plate Loading Tests

1. Net allowable bearing pressures of at least 120 kN/m<sup>2</sup> could be suggested for the foundations to any intended development.
2. Values of the deformation modulus  $E_v$  calculated from these tests indicate that  $E_v$  decreases with increasing pressure from about 40 to 15 MN/m<sup>2</sup> in the pressure range 0 to 400 kN/m<sup>2</sup>. It would not be appropriate to use modulus values determined from these tests for finite element analysis.

##### Penetrometer Testing

3. 'N' values indicate that this 'fresh' backfill is of relatively uniform density throughout, typically indicating a medium dense condition.
4. Static Cone penetrometer testing indicates that (in accordance with the normal categories available) the backfill should be classified as a sandy clay. With this test being continuous the high degree of variation in the composition of the fill is clearly illustrated.
5. Comparing the SPT 'N' values and static cone end resistance a correlation factor of 2 to 3 is suggested.

##### Settlement Observations

6. 'Creep' settlement is effectively completed within 18 months of restoration.

7. A linear relationship has been confirmed when plotting settlement, expressed as a percentage of fill height, against logarithm of time. In addition, with increasing thickness of fill the magnitude of creep settlement increases BUT the settlement expressed as a percentage of fill height decreases.

This is the same relationship as established at Essington; for comparison the mean values from Essington have been re-plotted with zero settlement at one month (Figure 5.3.71). The agreement between these two sites is extremely close, the only major variation being for the shallowest fill category in each case. Since this category is the most prone to be inaccurate (since the stations are typically at the margins of the site where the level is rapidly changing) this variation is not unexpected.
8. Using the relationships determined for settlement against fill height, predicted settlement profiles can be calculated across highwall sections. These have been found to closely match the recorded settlement profiles. From these profiles, zones of unacceptable differential settlement adjacent to the highwall zones can be accurately determined.
9. Although the magnitude of settlement decreases with depth within the backfill, it does not appear to be in direct proportion to increasing overburden pressure. A marked increase in the vertical compression below about 15 metres coincides with the standing water level indicating that saturation of the fill may cause additional settlement of the backfill.



Aston University

**Content has been removed for copyright reasons**

GENERAL LOCATION PLAN - HURST.

Scale 1:50 000

FIGURE 5.3.1.



Aston University

**Content has been removed for copyright reasons**

GEOLOGICAL SUCCESSION - extract from Geological Survey  
Sheet SO 98 NW (1981).

FIGURE 5.3.2



Aston University

**Content has been removed for copyright reasons**

GENERAL GEOLOGY - extract from 1:10 000 scale Geological Survey (1981).

FIGURE 5.3.3

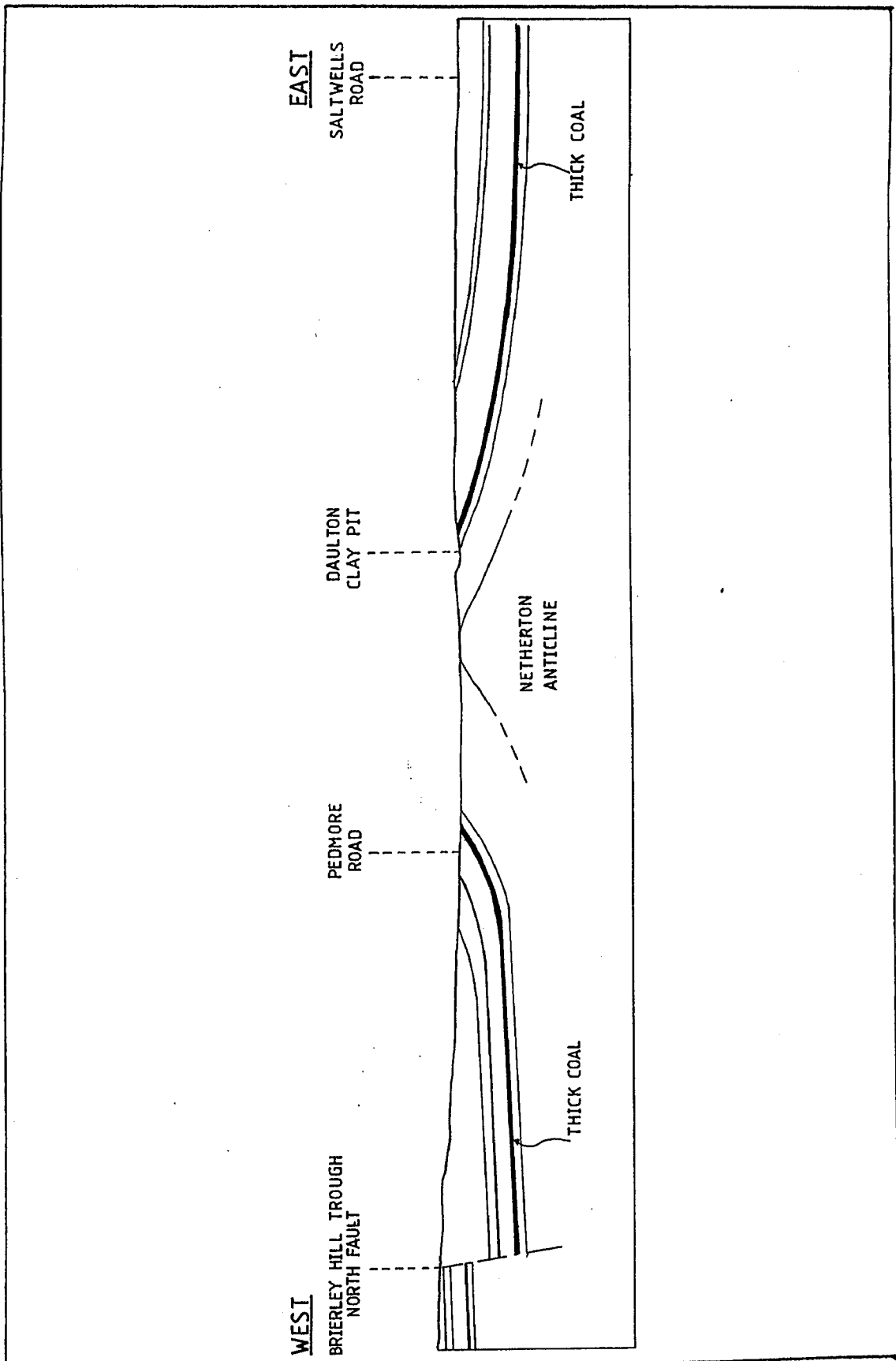

GENERAL GEOLOGICAL SECTION.  
Not to scale.

FIGURE 5-3-4.

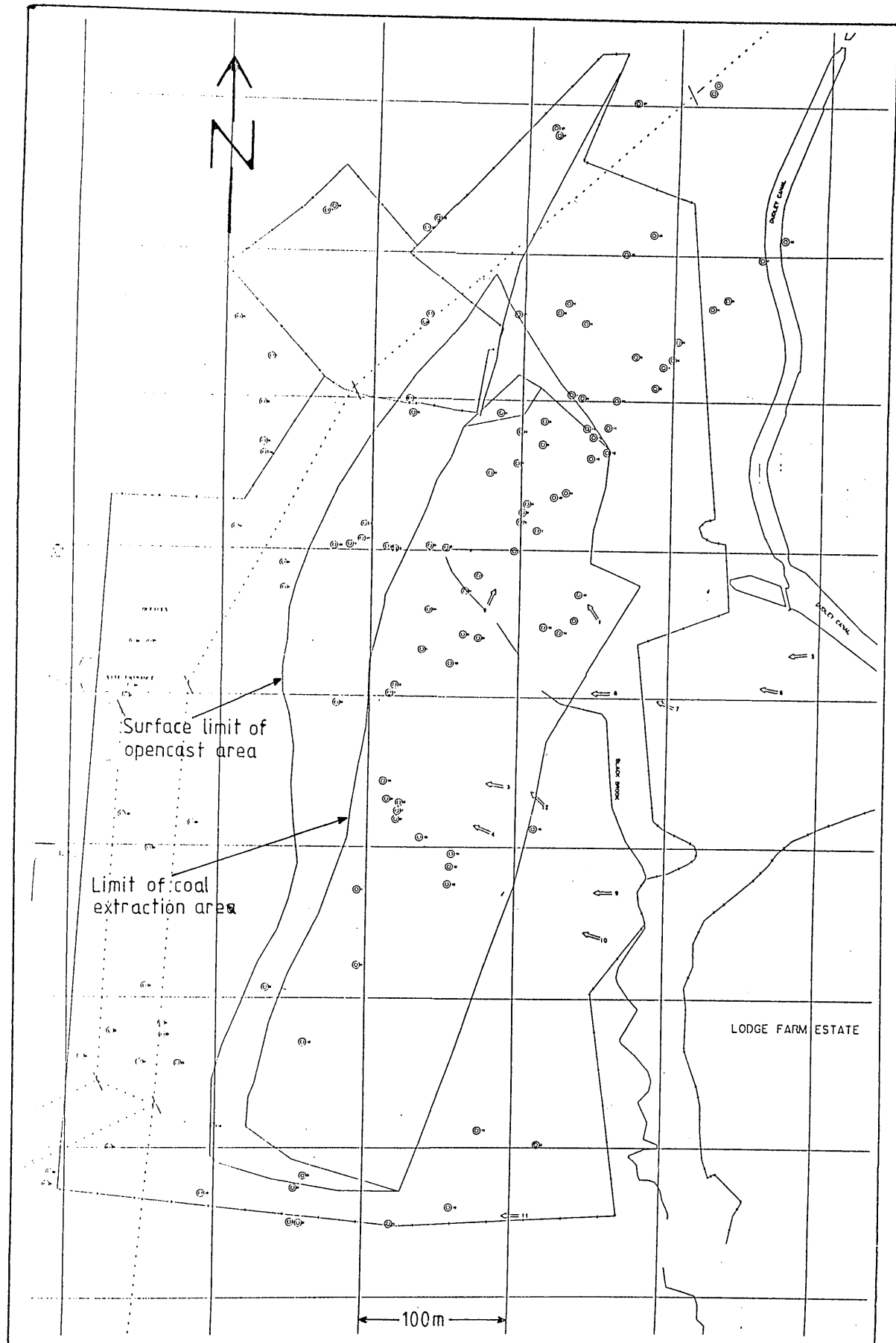

LOCATION OF ABANDONED MINESHAFTS AND ADITS.  
HURST.

FIGURE 5.3.5



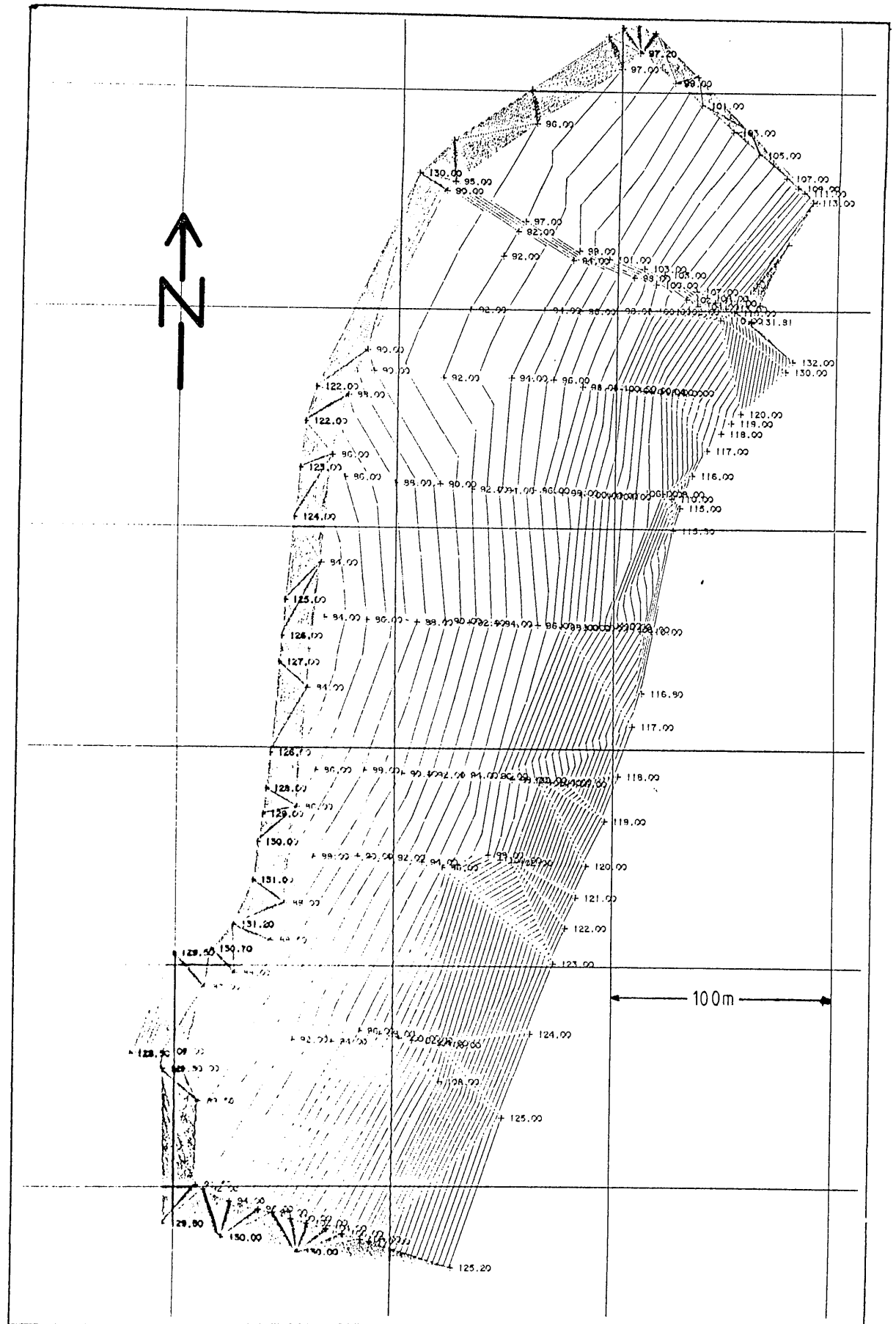

TOTAL EXCAVATION AREA - HURST.

FIGURE 5.3.6.

START CO-ORDS  
 93000.000 87450.000  
 END CO-ORDS  
 93270.000 89100.000  
 BEARING 22 33 26

- 1 --- April 1986
- 2 --- June 1985
- 3 --- May 1985
- 4 --- September 1984
- 5 --- April 1984
- 6 --- June 1983

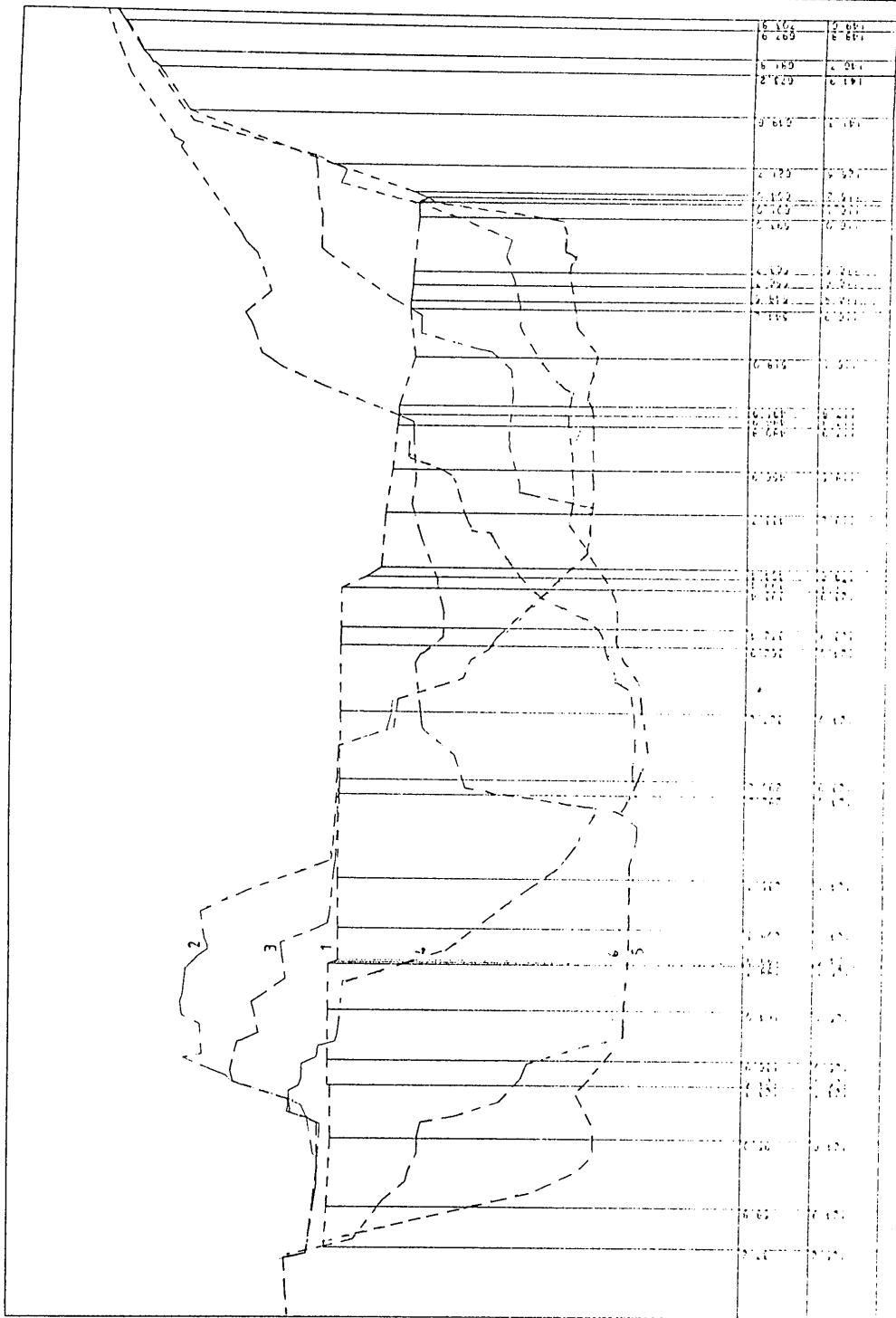

6	100	0
6	200	0
6	300	0
6	400	0
6	500	0
6	600	0
6	700	0
6	800	0
6	900	0
6	1000	0
6	1100	0
6	1200	0
6	1300	0
6	1400	0
6	1500	0
6	1600	0
6	1700	0
6	1800	0
6	1900	0
6	2000	0
6	2100	0
6	2200	0
6	2300	0
6	2400	0
6	2500	0
6	2600	0
6	2700	0
6	2800	0
6	2900	0
6	3000	0
6	3100	0
6	3200	0
6	3300	0
6	3400	0
6	3500	0
6	3600	0
6	3700	0
6	3800	0
6	3900	0
6	4000	0
6	4100	0
6	4200	0
6	4300	0
6	4400	0
6	4500	0
6	4600	0
6	4700	0
6	4800	0
6	4900	0
6	5000	0
6	5100	0
6	5200	0
6	5300	0
6	5400	0
6	5500	0
6	5600	0
6	5700	0
6	5800	0
6	5900	0
6	6000	0
6	6100	0
6	6200	0
6	6300	0
6	6400	0
6	6500	0
6	6600	0
6	6700	0
6	6800	0
6	6900	0
6	7000	0
6	7100	0
6	7200	0
6	7300	0
6	7400	0
6	7500	0
6	7600	0
6	7700	0
6	7800	0
6	7900	0
6	8000	0
6	8100	0
6	8200	0
6	8300	0
6	8400	0
6	8500	0
6	8600	0
6	8700	0
6	8800	0
6	8900	0
6	9000	0
6	9100	0
6	9200	0
6	9300	0
6	9400	0
6	9500	0
6	9600	0
6	9700	0
6	9800	0
6	9900	0
6	10000	0

LONG SECTION SOUTH-NORTH THROUGH OPENCAST AREA  
 - indicating progressive development.

FIGURE 5.3.7.

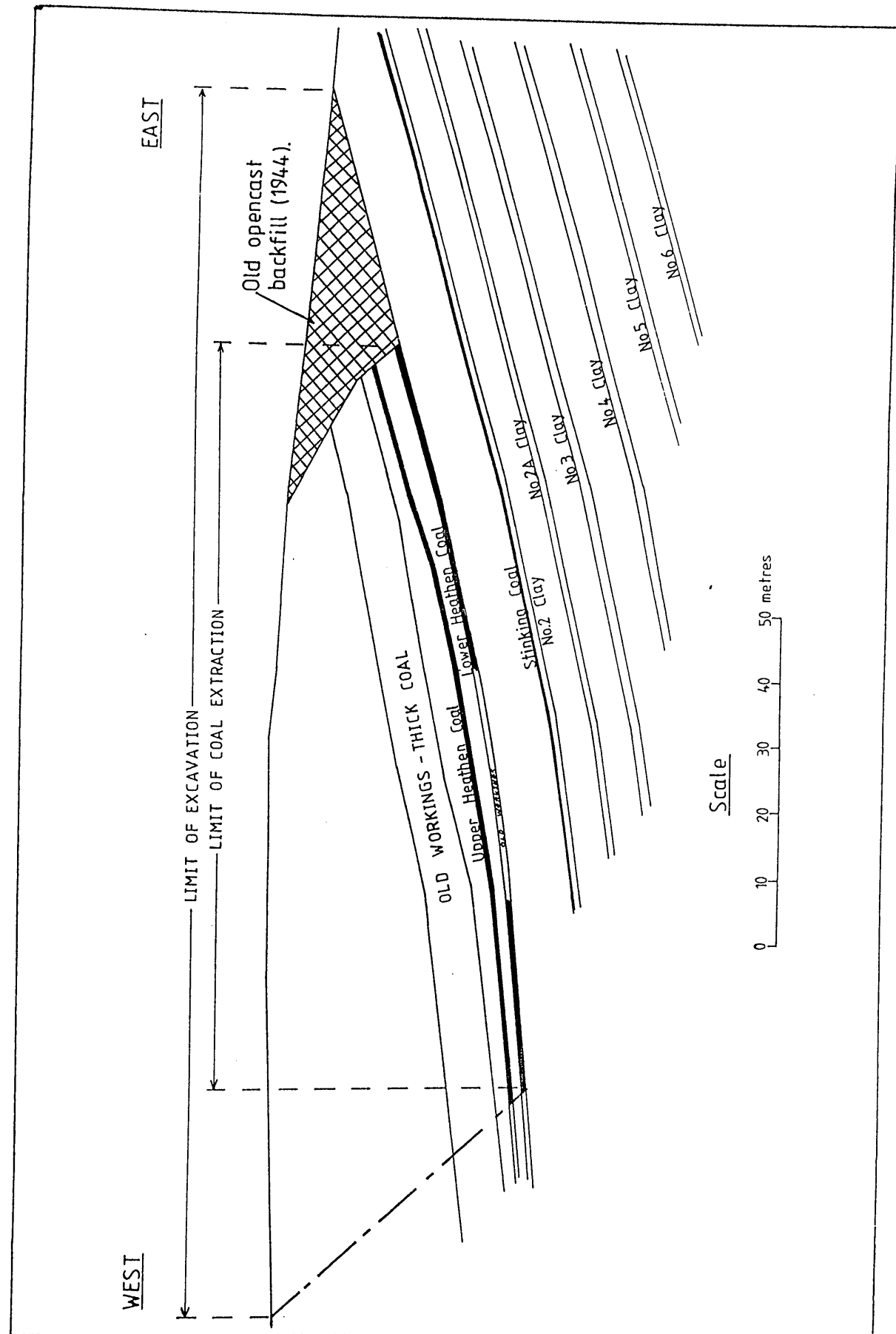

TYPICAL SECTION EAST-WEST ACROSS OPENCAST EXCAVATION - HURST.

FIGURE 5.3.8.

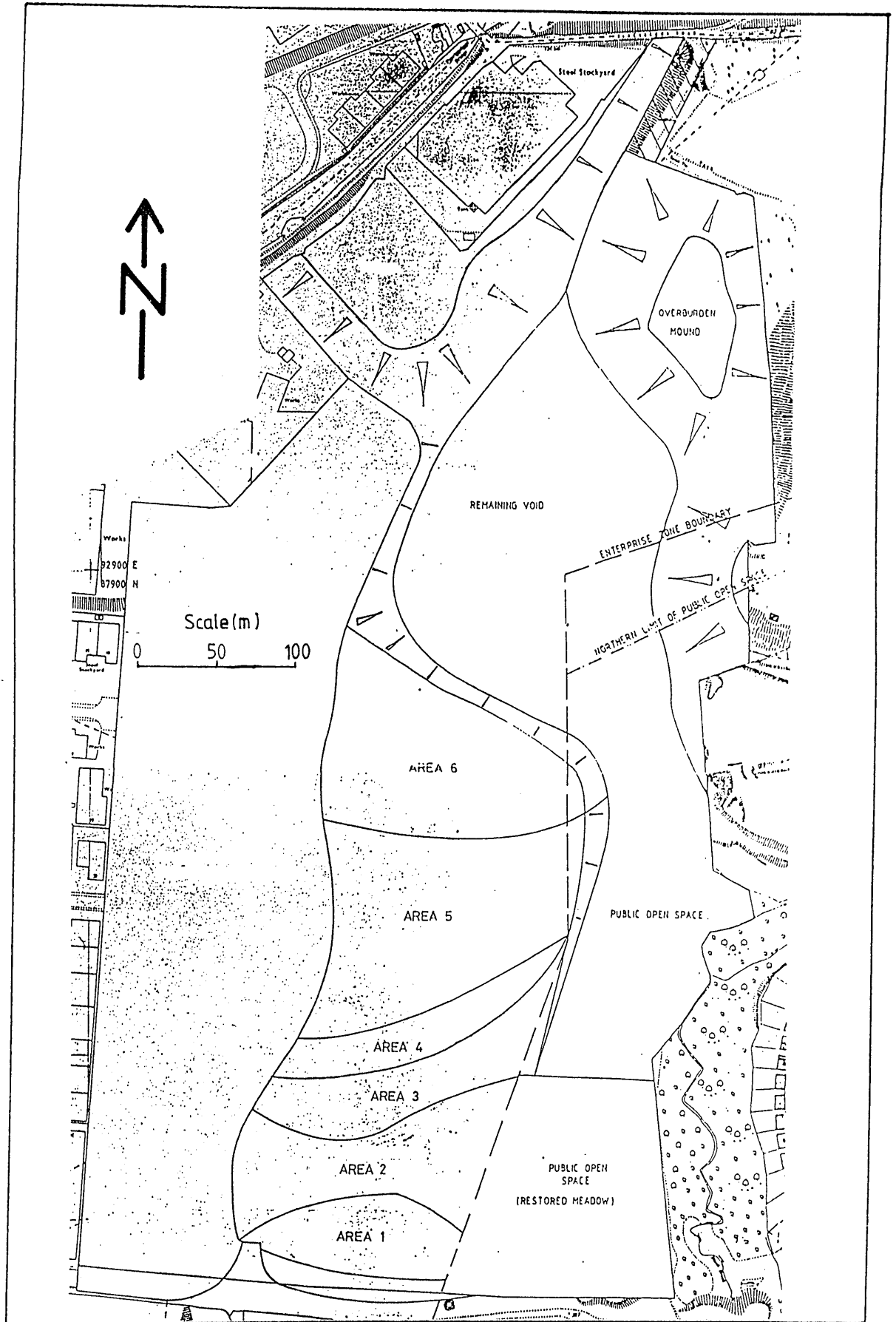

MAIN BACKFILL BENCHES - HURST.

FIGURE 5.3.9.

Area 1

Backfill commenced January 1984. Backfilled to within 3m of finished level by March 1984 and reached finished level by 30th April, 1984.

Area 2

Backfill commenced January 1984. Area backfilled to finished level by 22nd June, 1984.

Area 3

Backfill commenced April 1984. Area backfilled to finished level by 2nd August, 1984.

Area 4

Backfill commenced June, 1984. Area backfilled to finished level by 30th September, 1984.

Area 5

Backfill commenced September 1984. Backfilling reached 15m below finished level by 1st February, 1985 and reached finished level by 2nd May, 1984.

Area 6

Backfill commenced April 1985. Area backfilled to finished level by February, 1986.

GENERAL DETAILS OF BACKFILL AREAS.

HURST.

FIGURE 5.3.10.

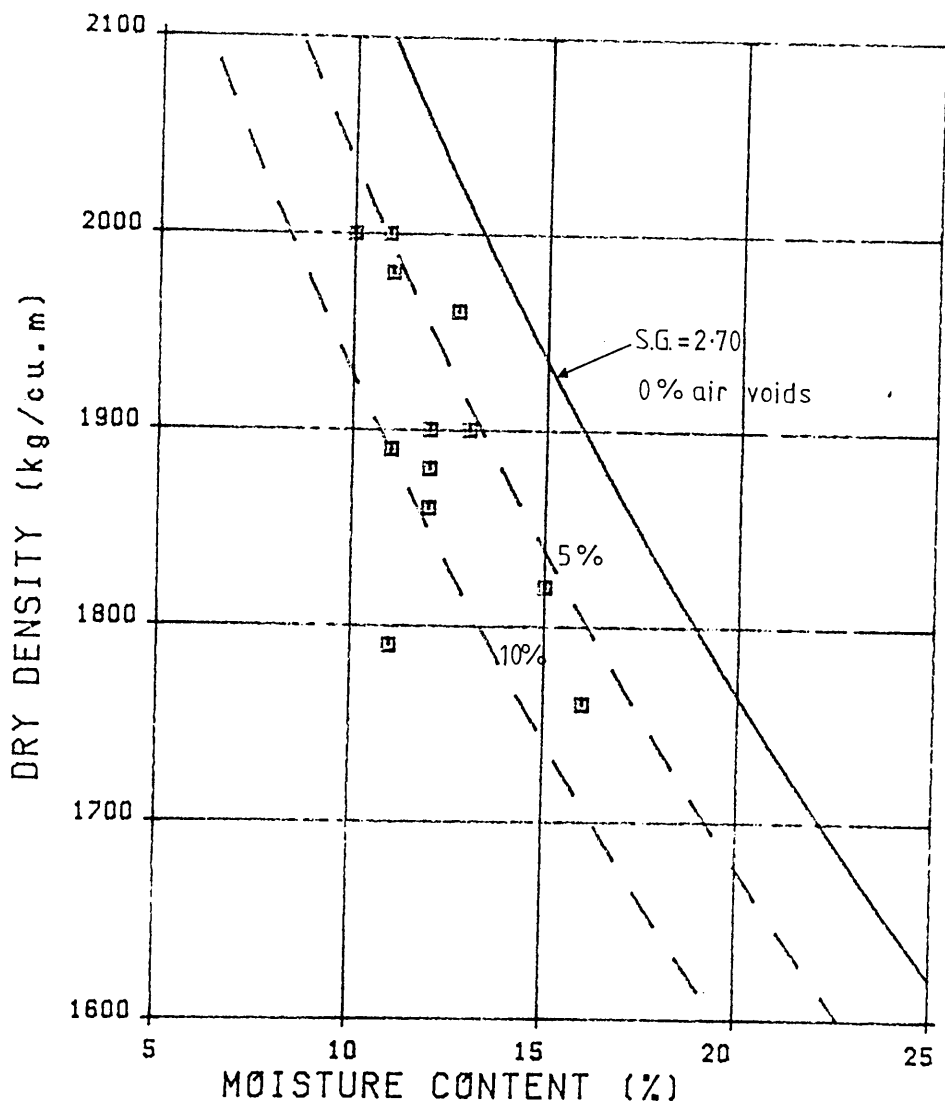

SOIL COMPACTION DATA - PROCTOR COMPACTION TESTS  
HURST.

FIGURE 5.3.11.

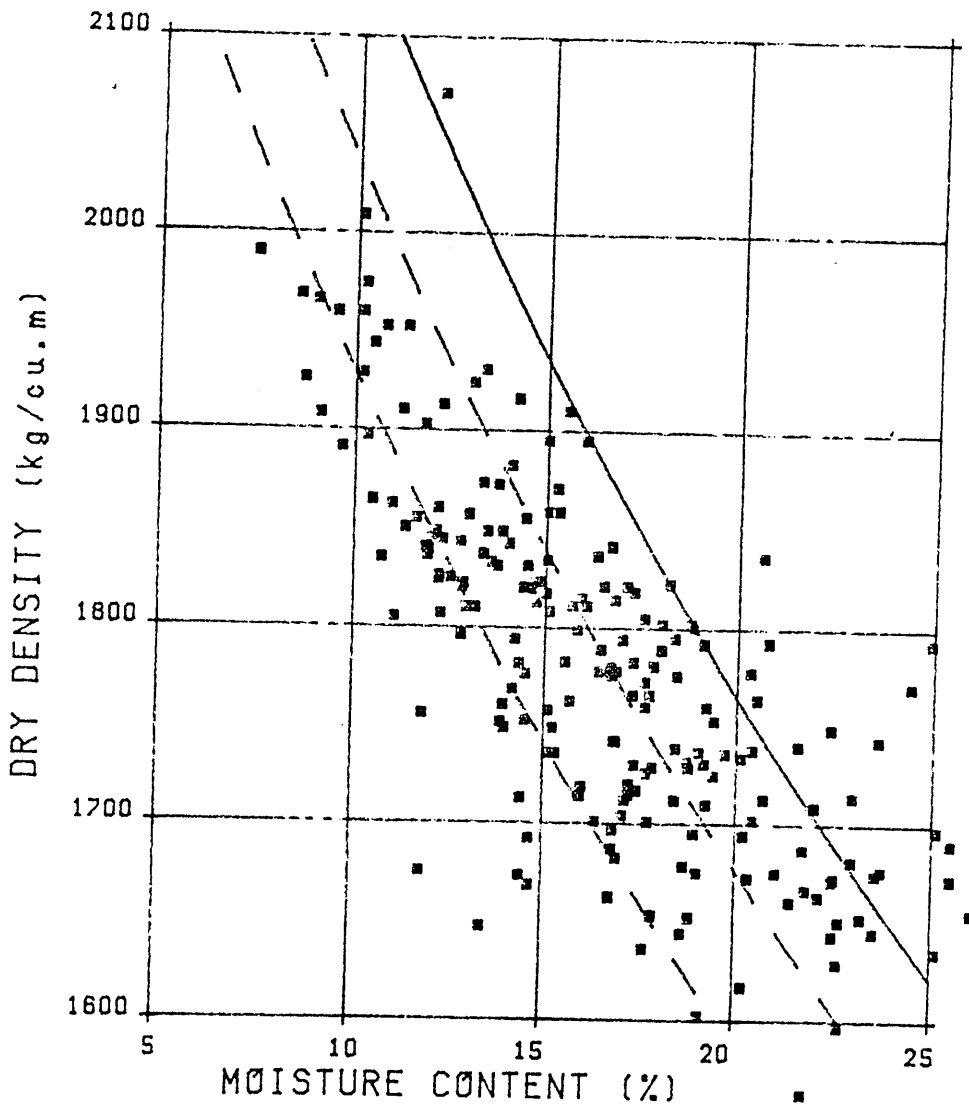

SOIL COMPACTION DATA - NUCLEAR GAUGE TESTS.

HURST.

FIGURE 5-3-12

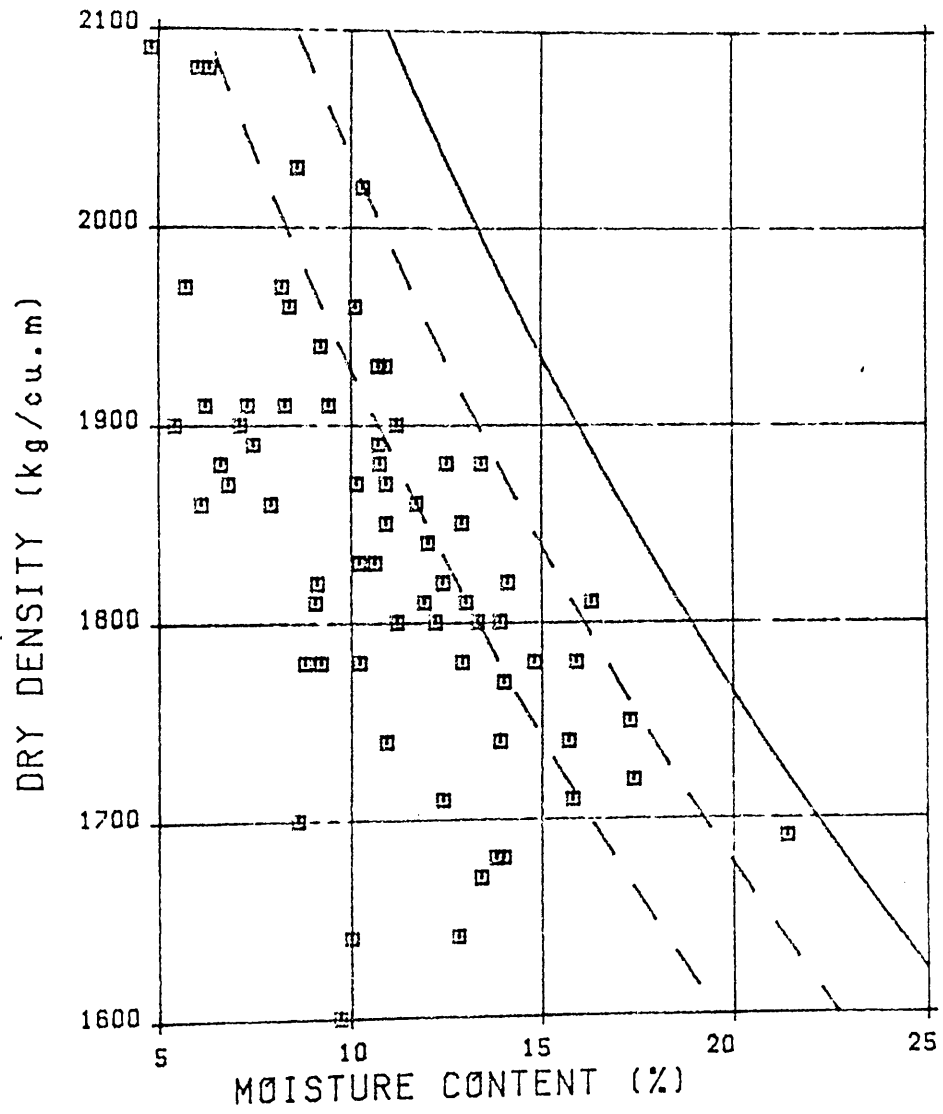

SOIL COMPACTION DATA - SAND REPLACEMENT TESTS.

HURST.

FIGURE 5-3-13.



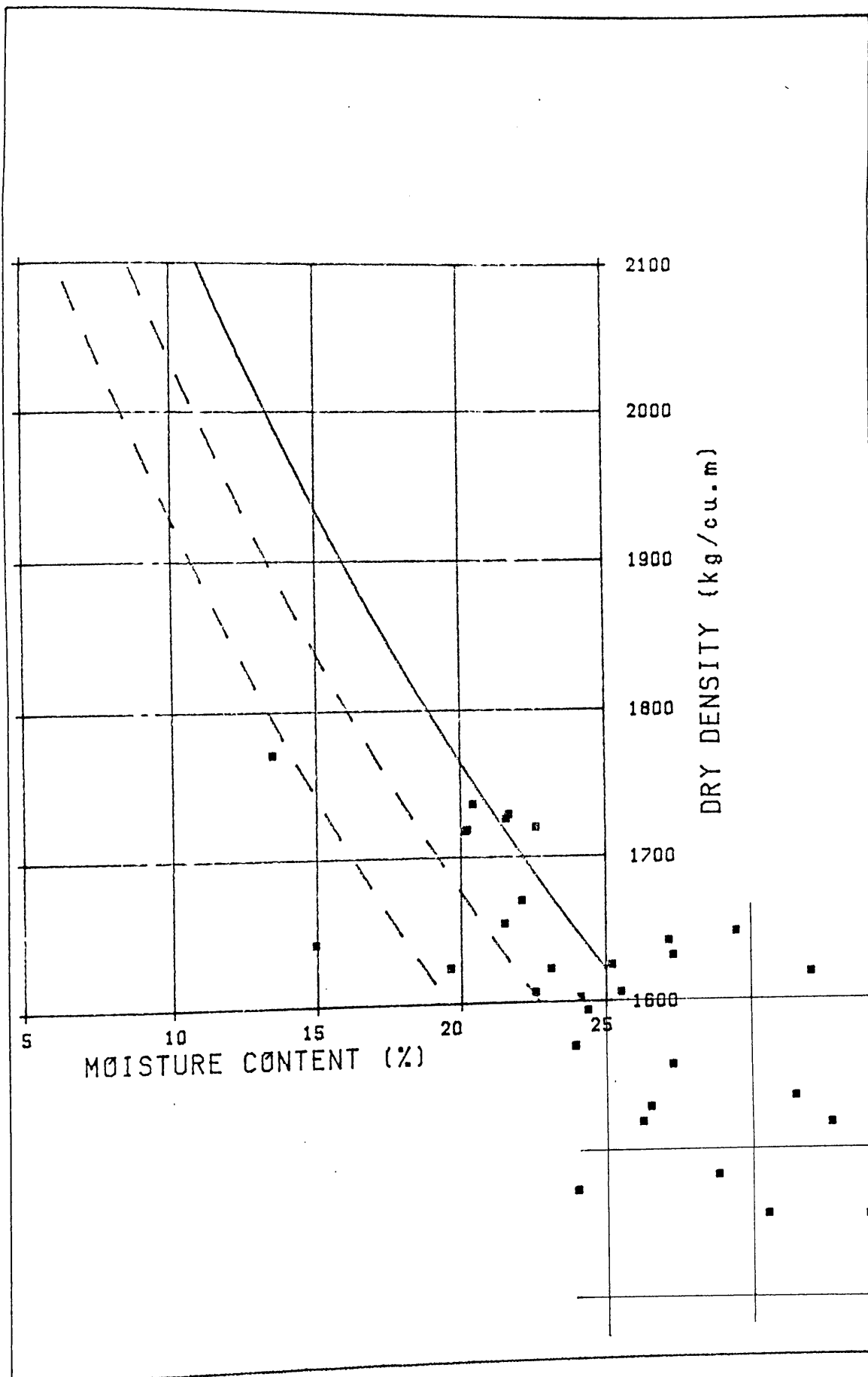

SOIL COMPACTION DATA - NUCLEAR GAUGE TESTS ON COALY SAMPLES. HURST.

FIGURE 5.3.14.

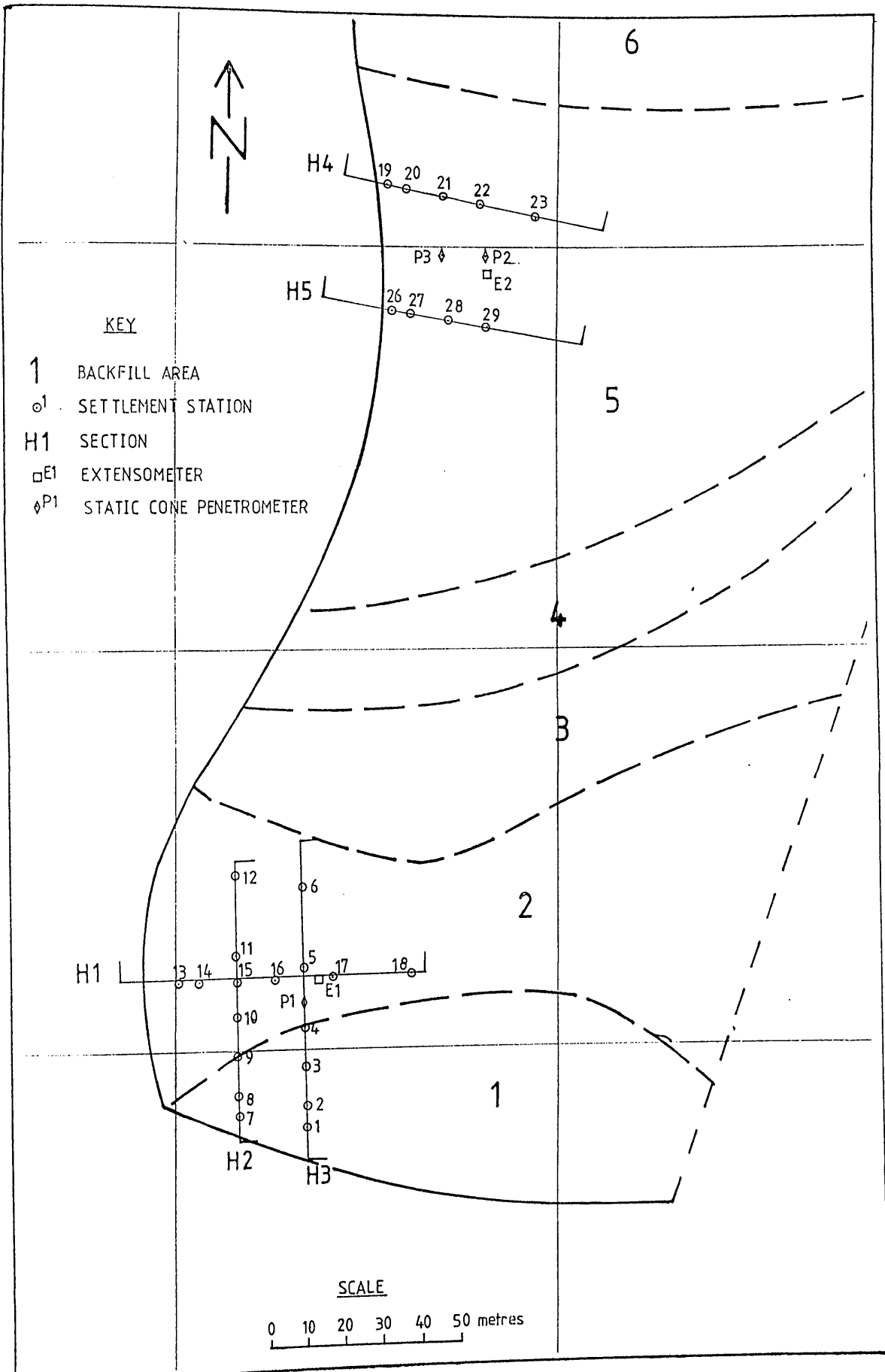

LOCATION OF TEST AND MONITORING POSITIONS - HURST.

FIGURE 5.3.15.

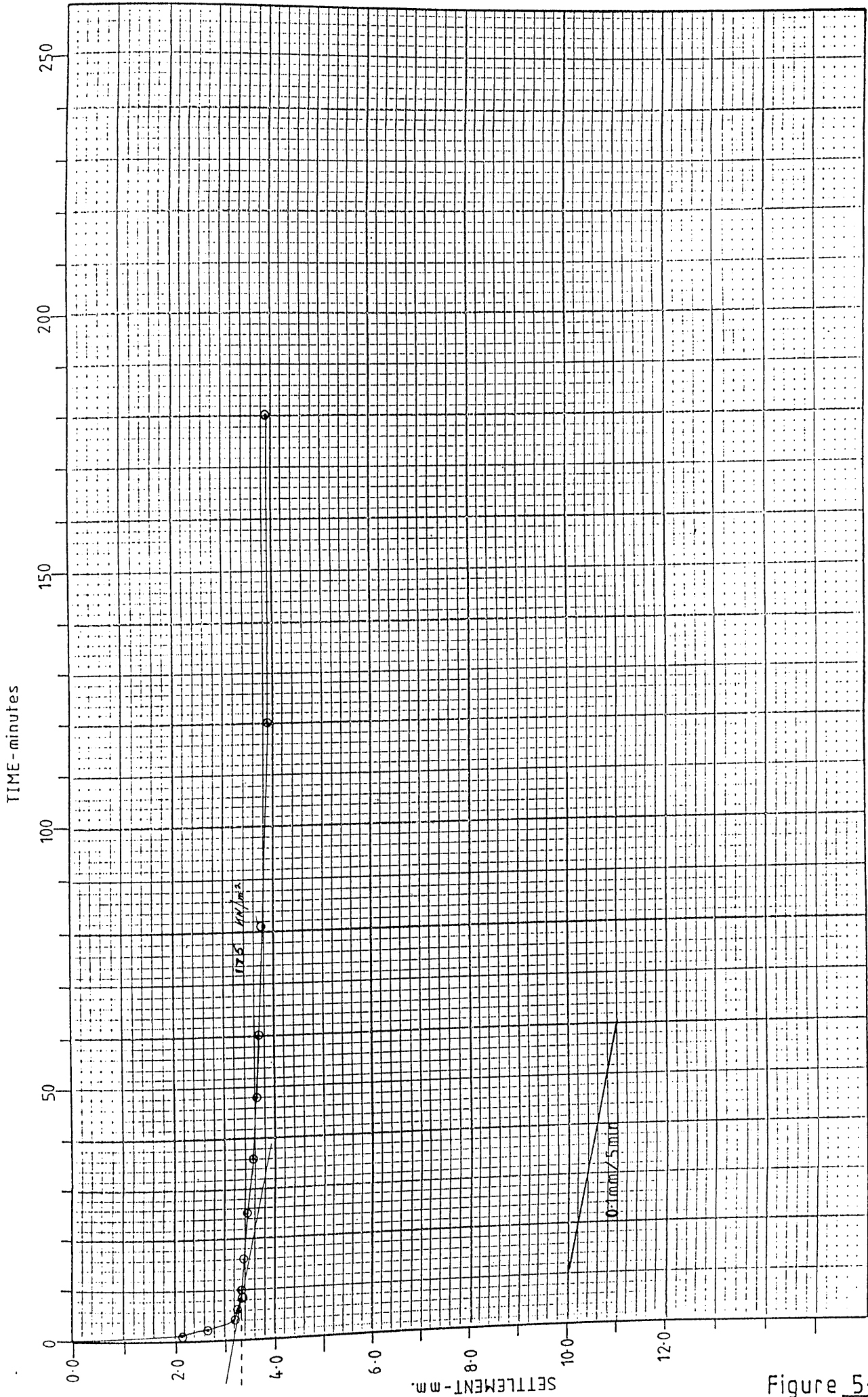

Figure 5.3.16

PLATE LOADING TEST - Consolidation Curves

TEST No. 2

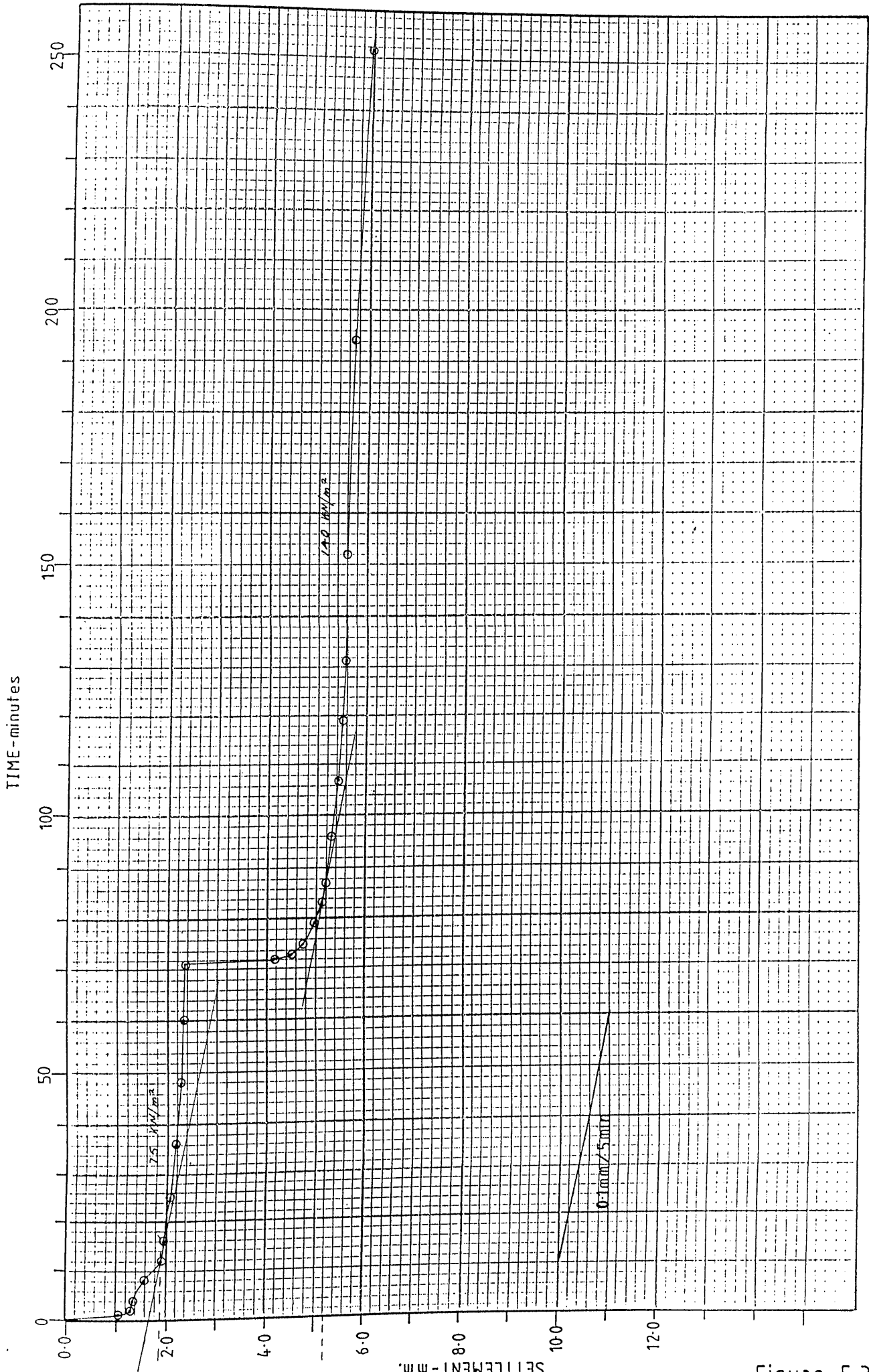

Figure 5.3.17

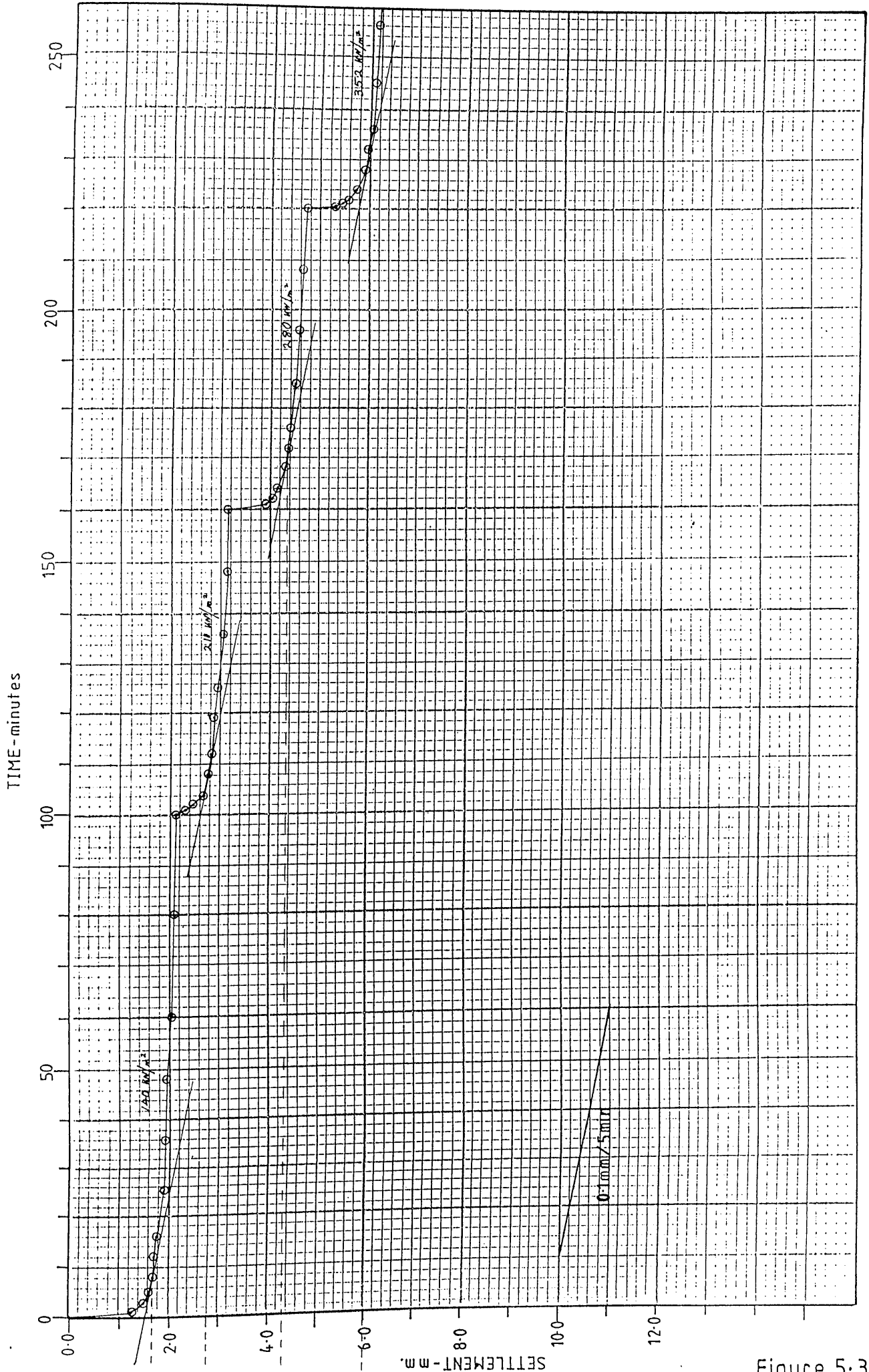

Figure 5.3-18.

PLATE LOADING TEST - Consolidation Curves

TEST No. 3

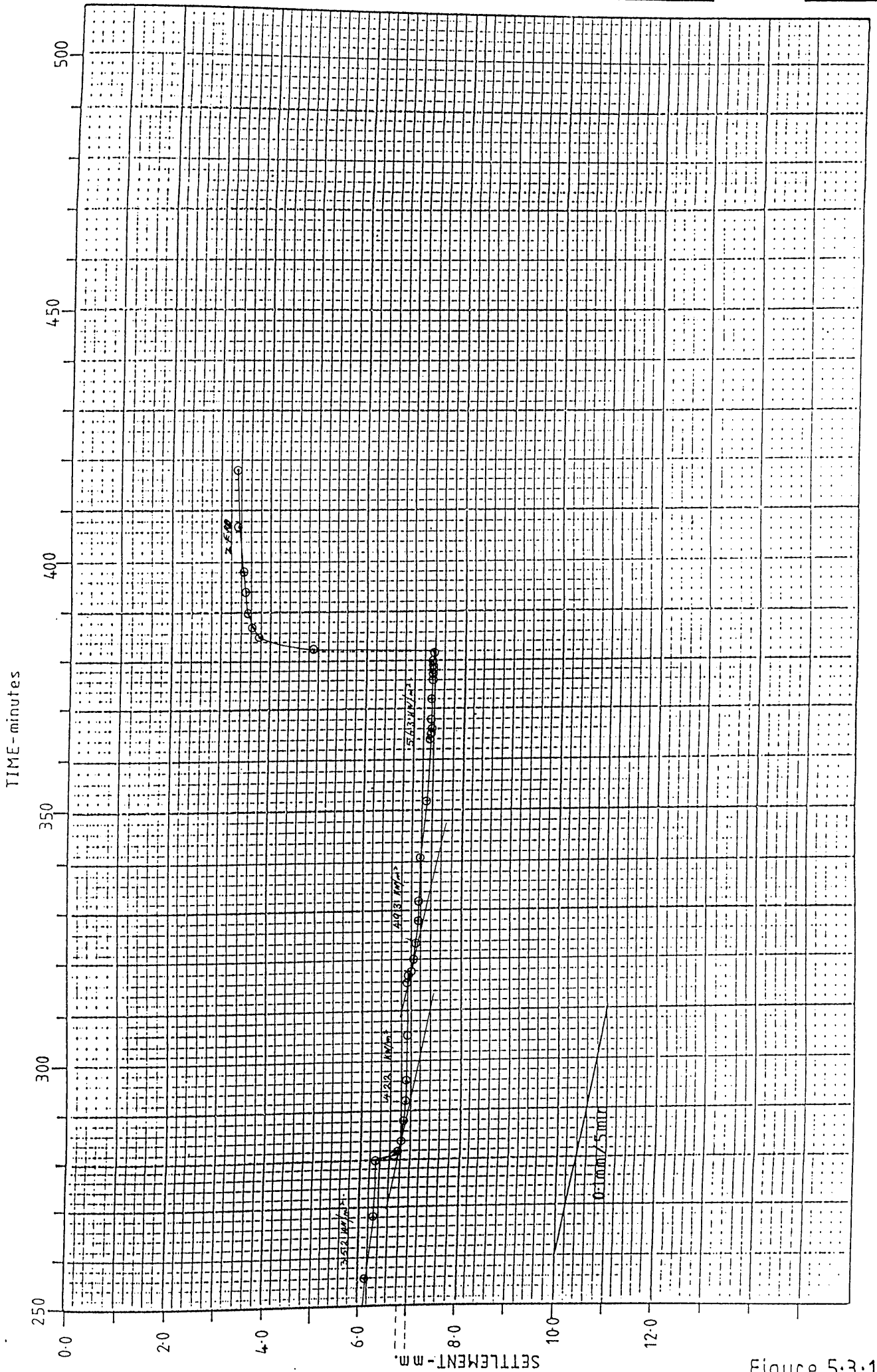

Figure 5.3.19.

PLATE LOADING TEST - Consolidation Curves

TEST No. 4

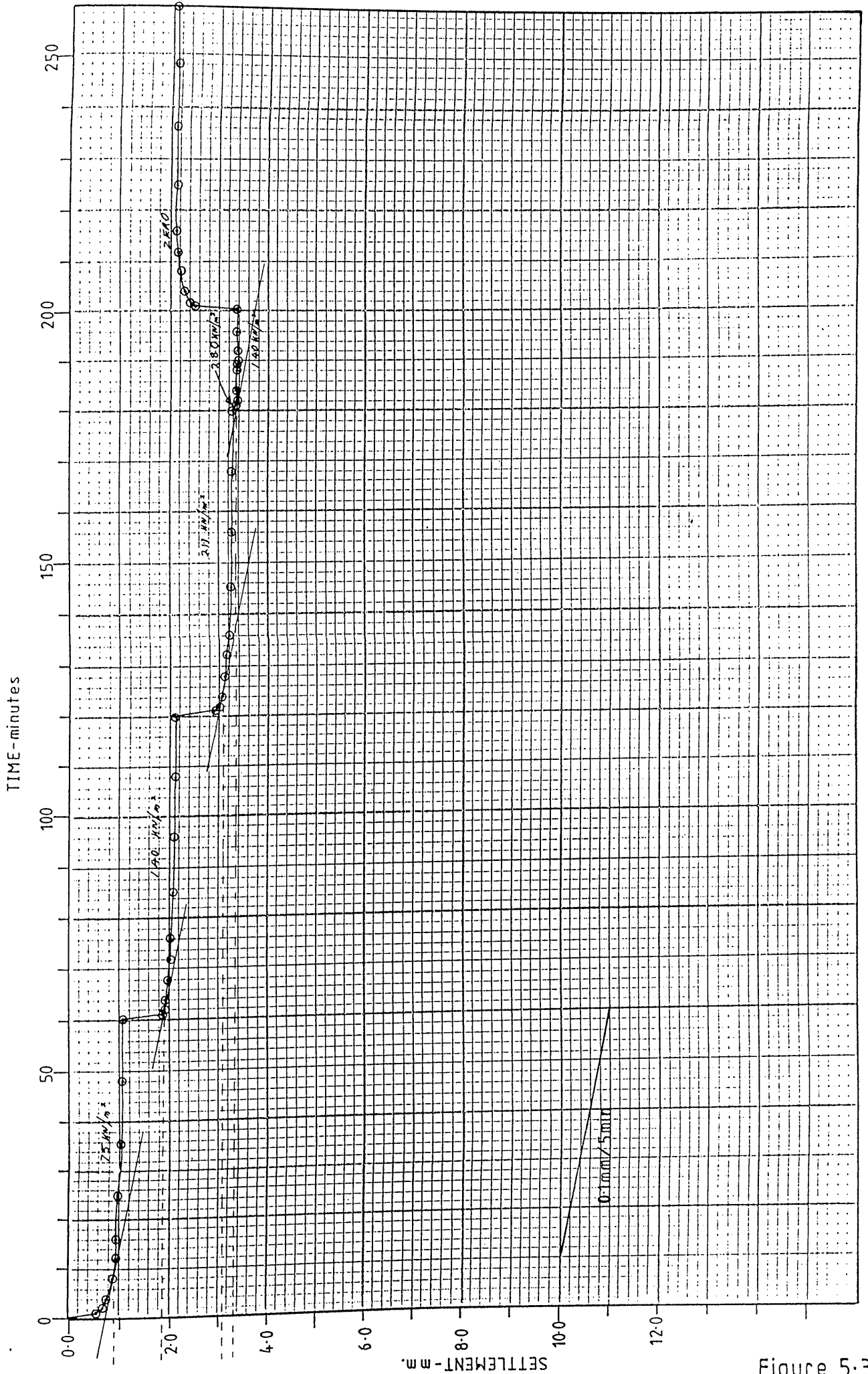
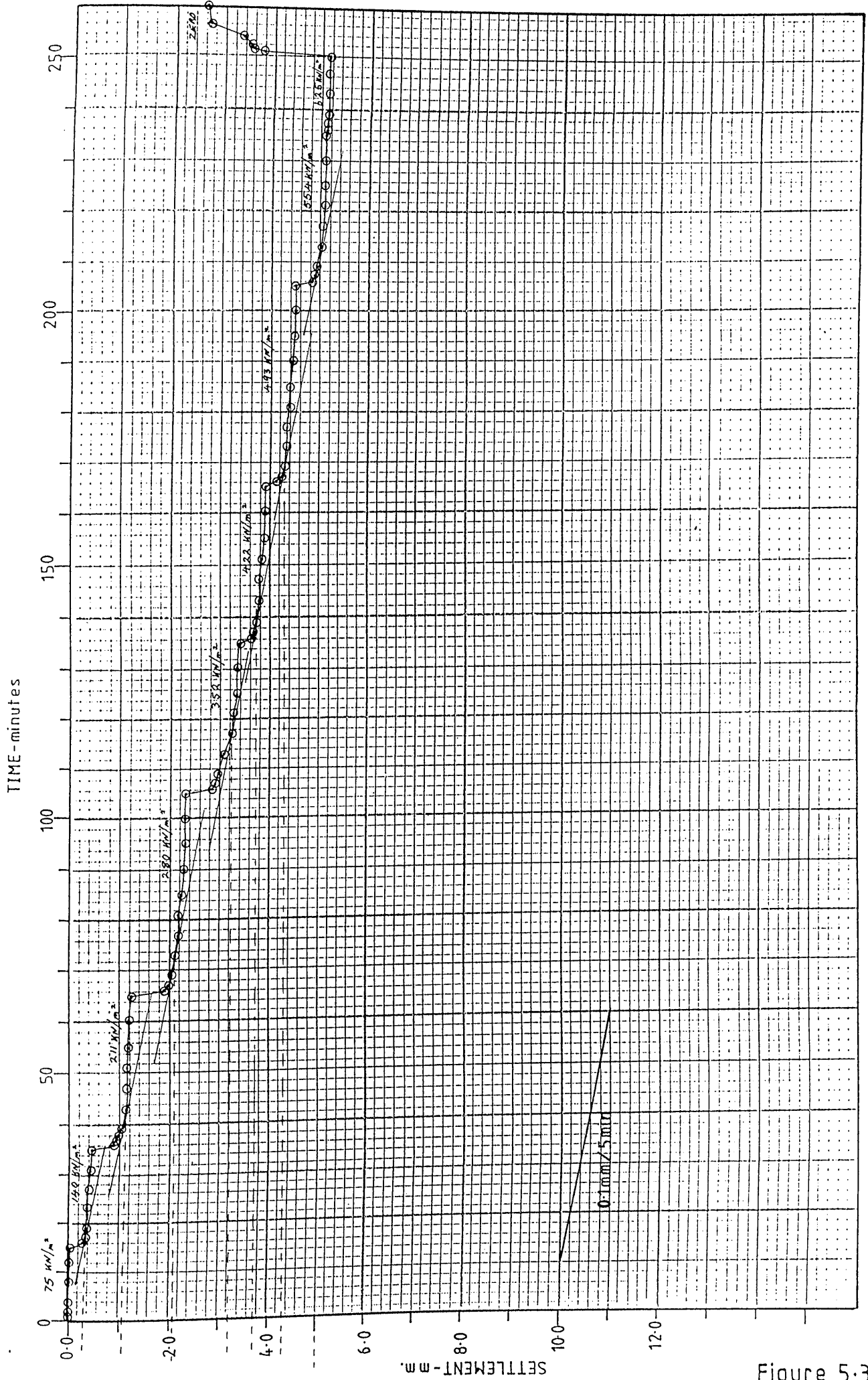

Figure 5.3.20.



SETTLEMENT-mm

Figure 5.3.21.



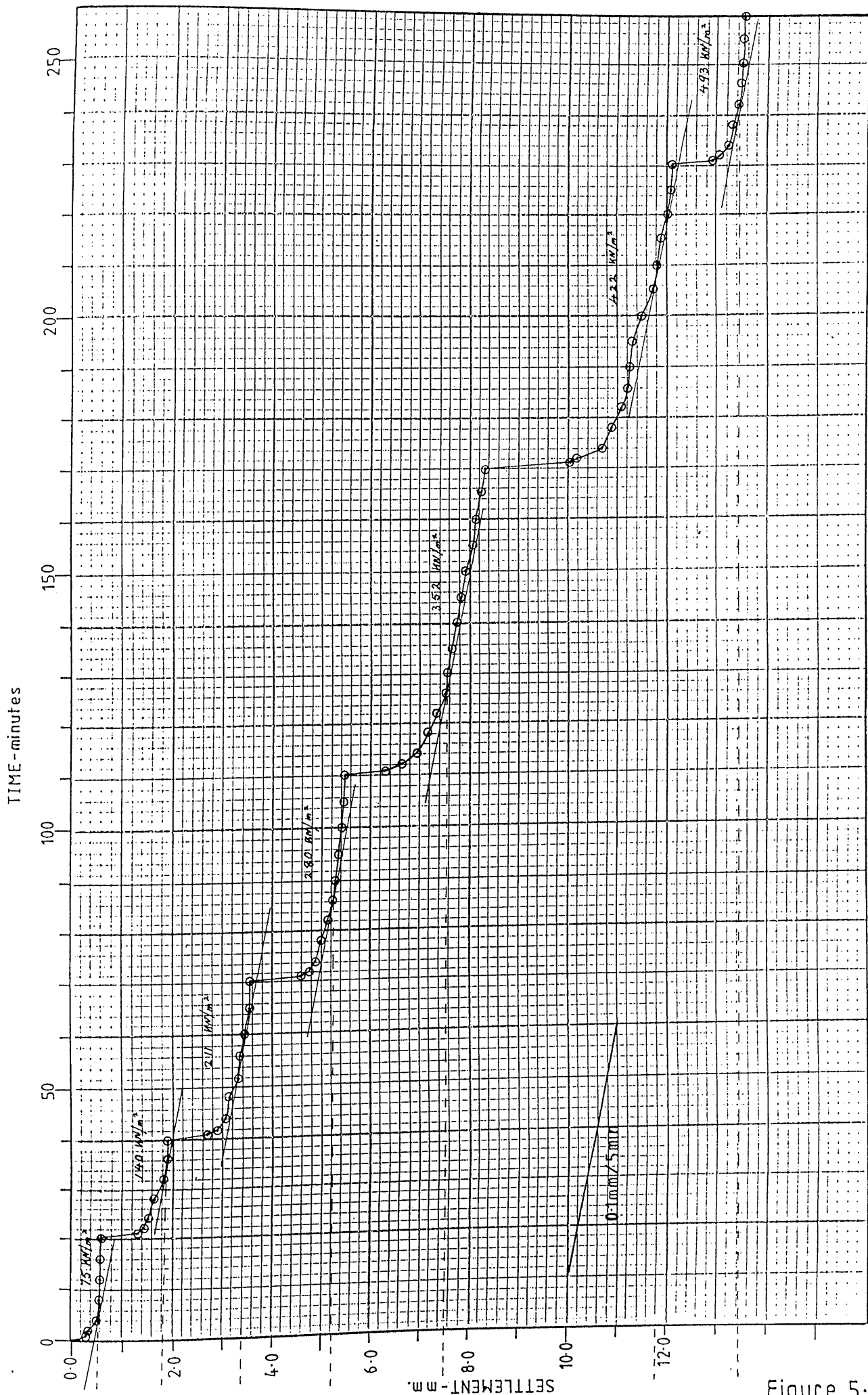

Figure 5.3.22

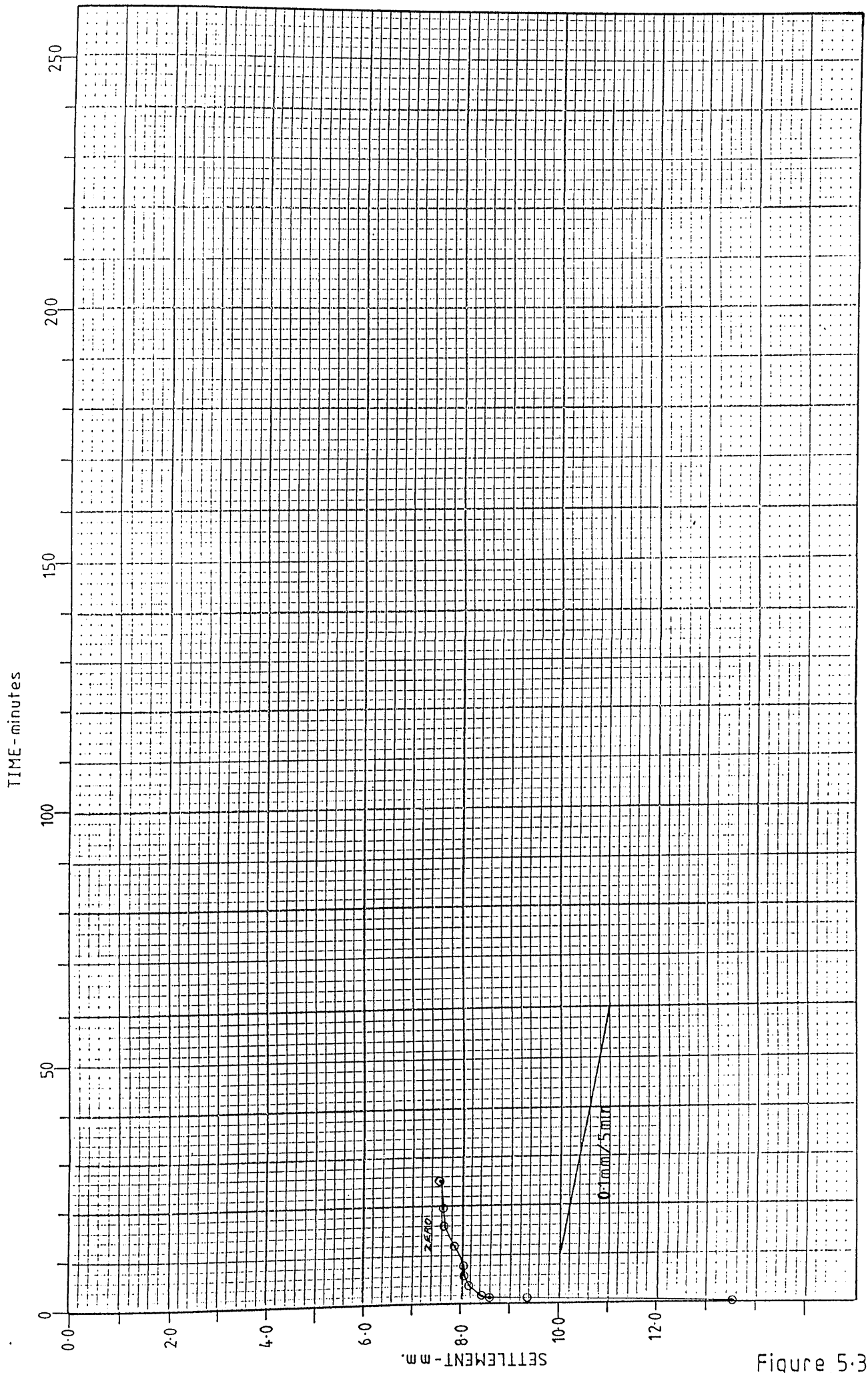
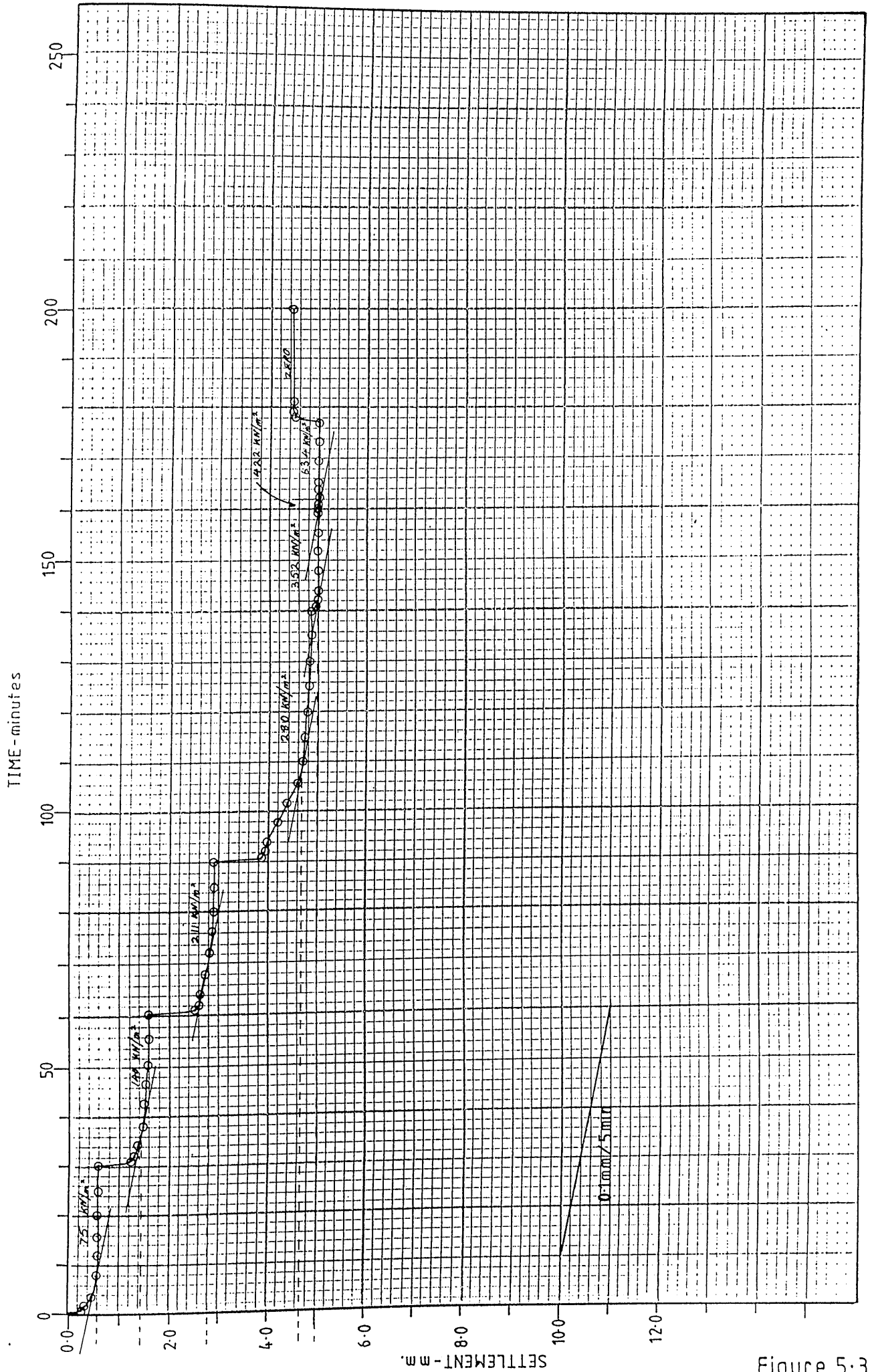

Figure 5.3.23.



SETTLEMENT - mm

Figure 5.3.24

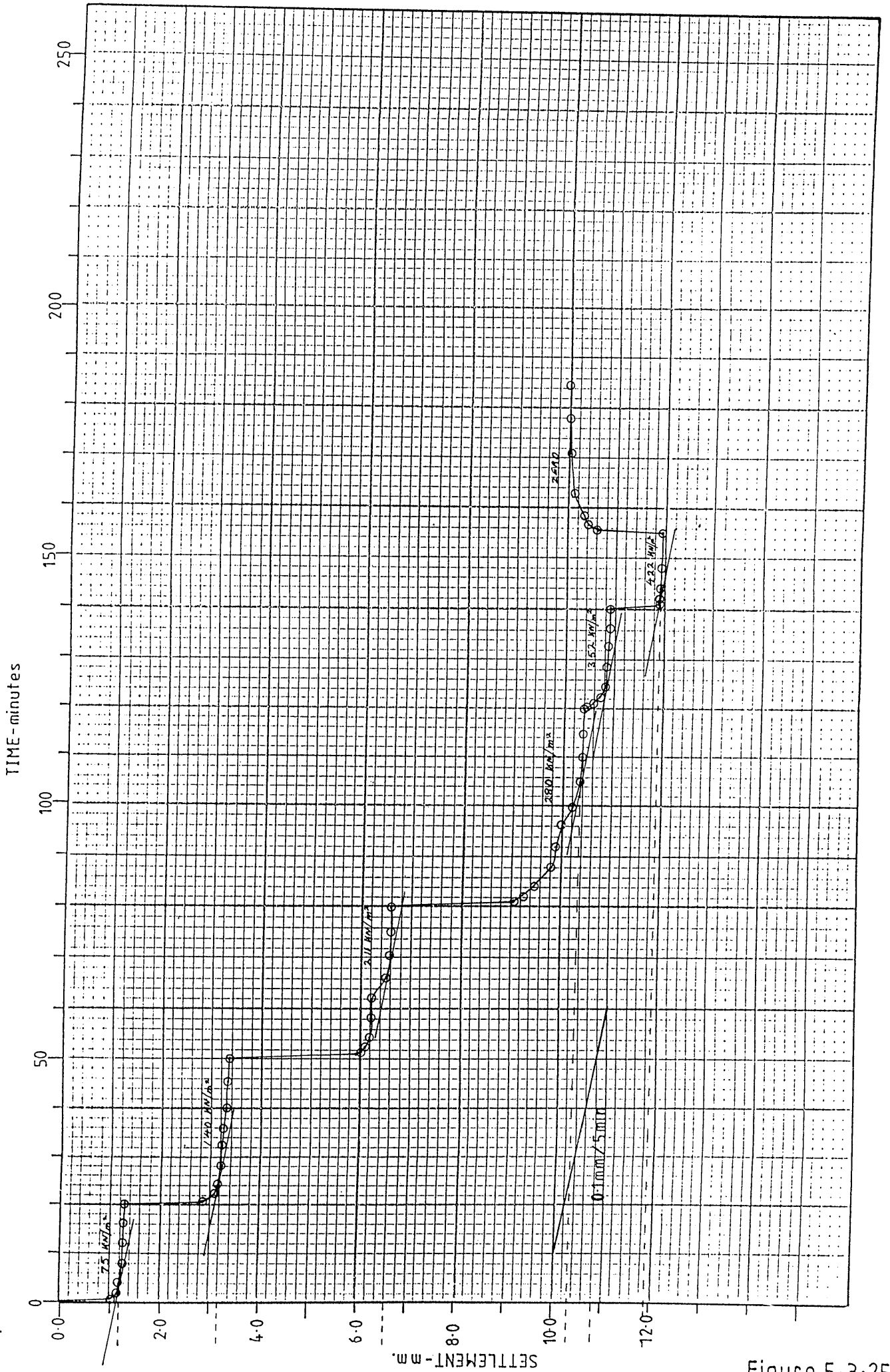

Figure 5.3-25

# PLATE LOADING TEST - PRESSURE - SETTLEMENT CURVE

TEST No. 1

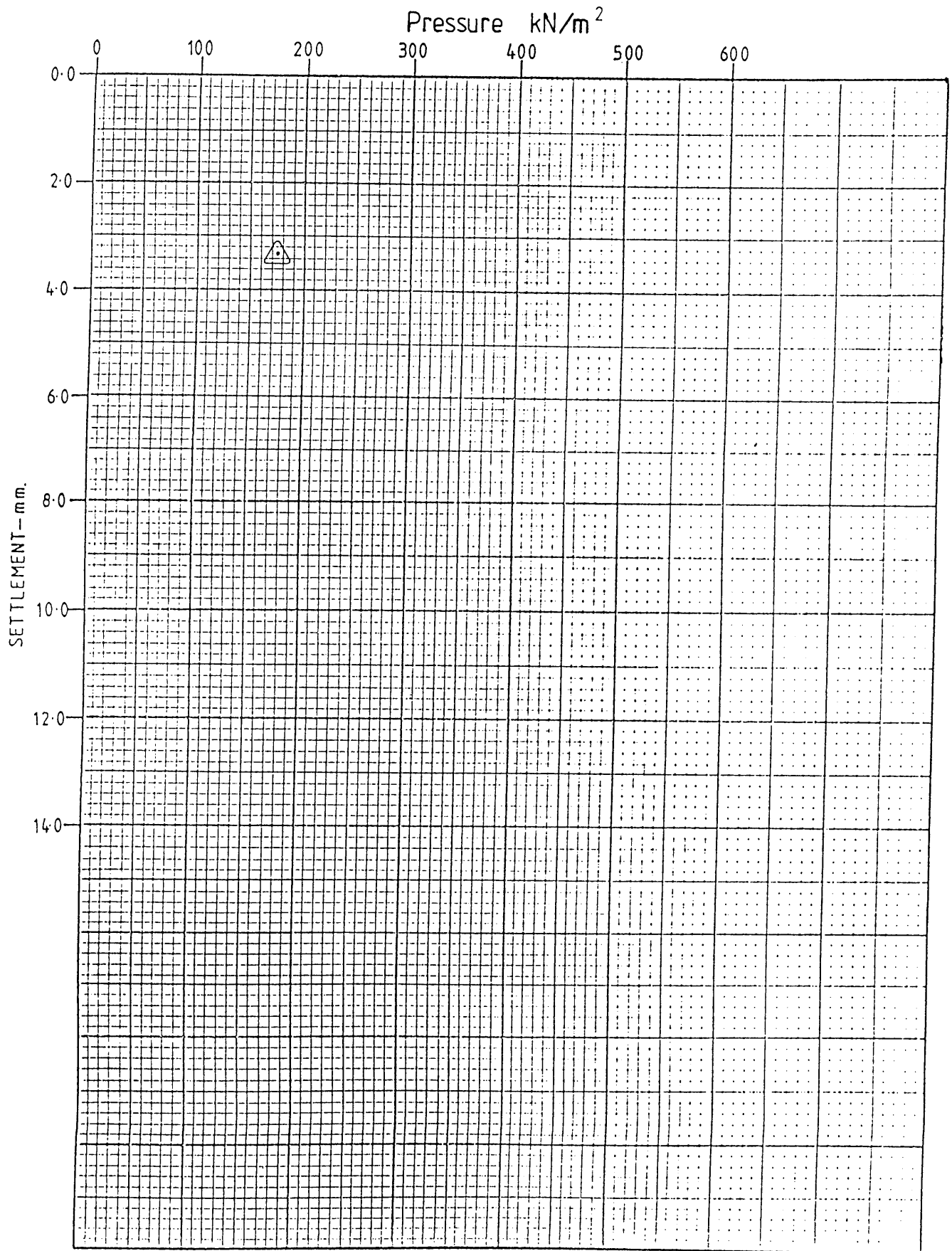

PLATE LOADING TEST - PRESSURE SETTLEMENT CURVE

TEST No. 2

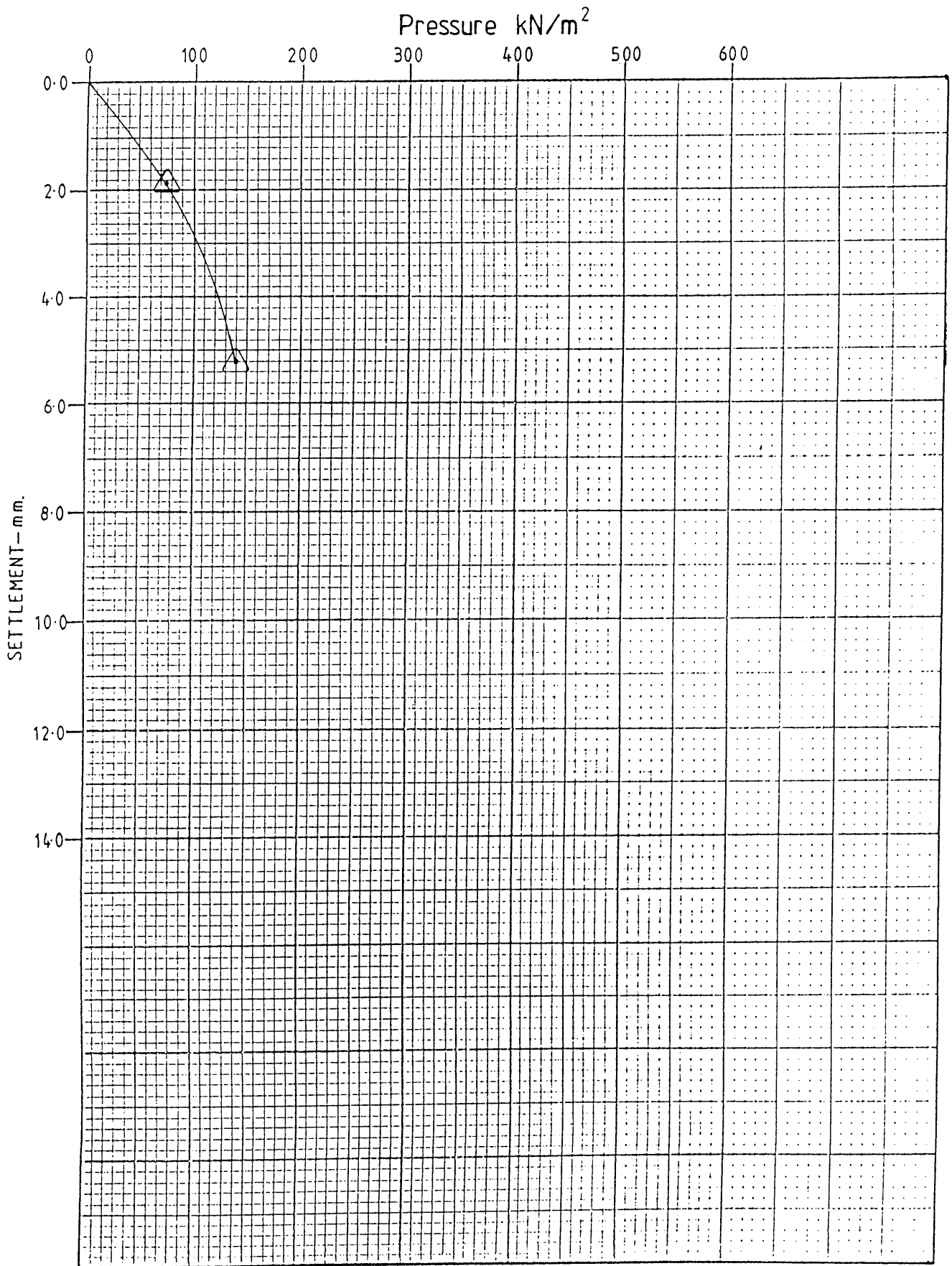

Figure 5.3.27.

# PLATE LOADING TEST - PRESSURE-SETTLEMENT CURVE

TEST No. 3

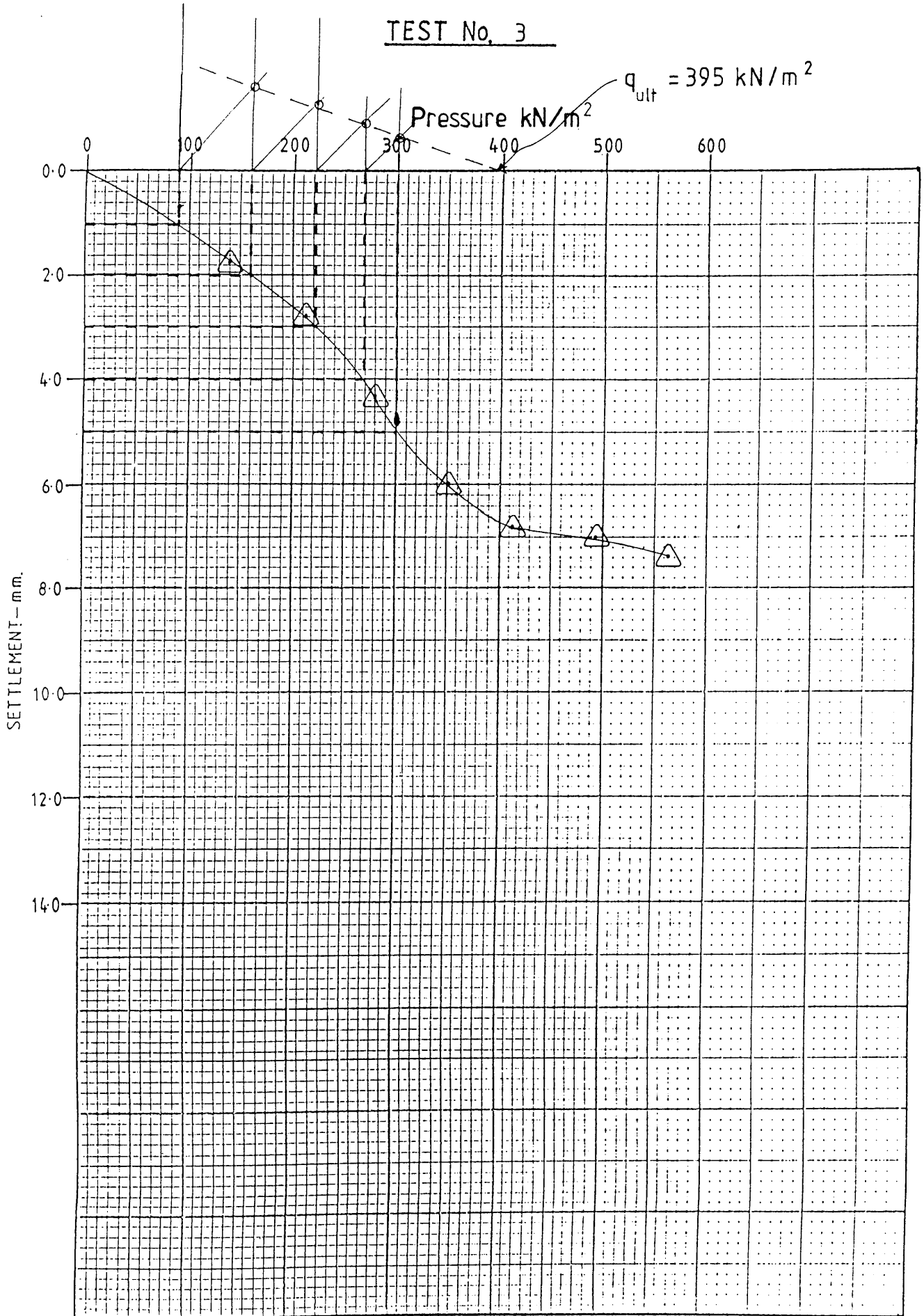

Figure 5.3.28

PLATE LOADING TEST - PRESSURE - SETTLEMENT CURVE

TEST No. 4

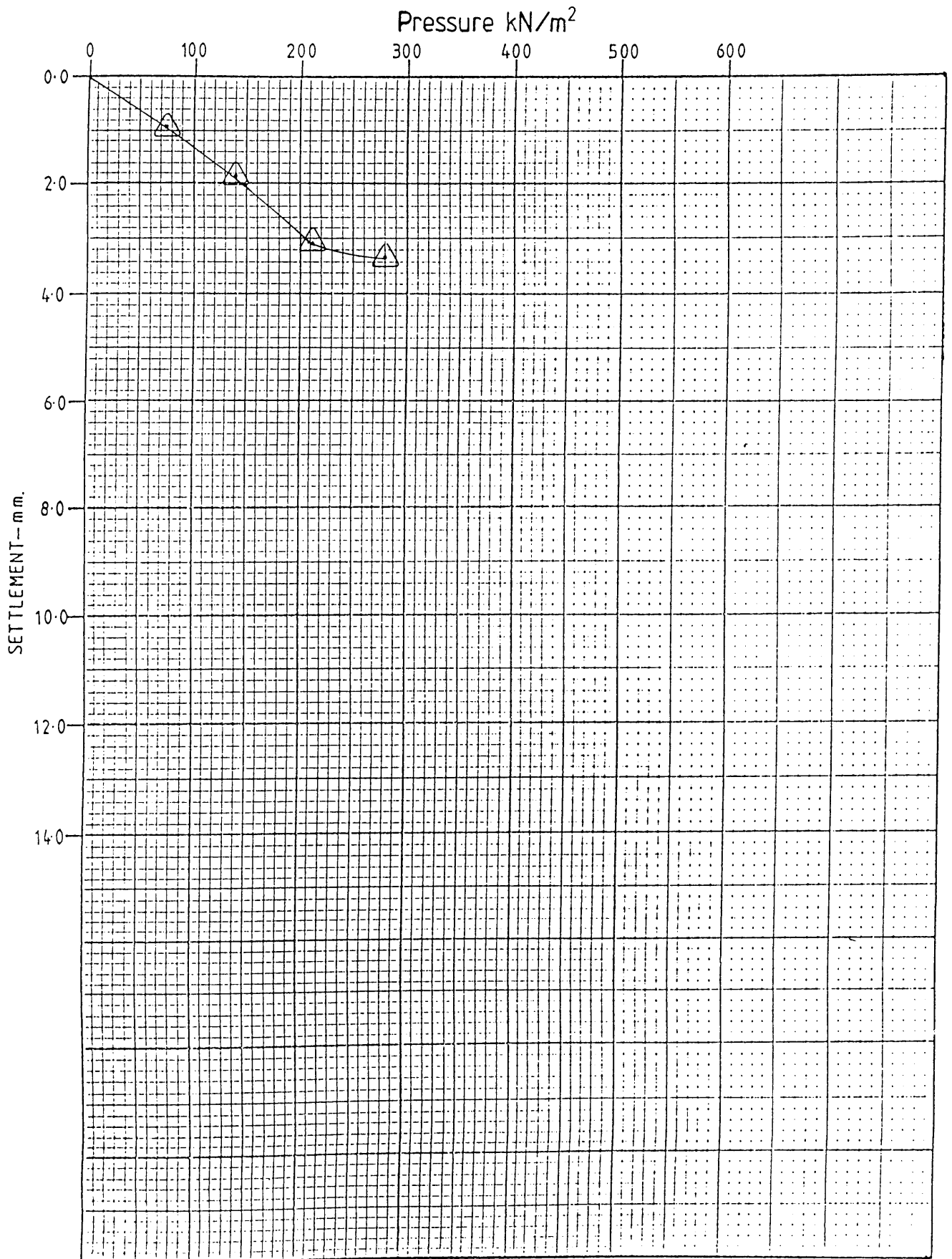

Figure 5.3.29.



PLATE LOADING TEST - PRESSURE SETTLEMENT CURVE

TEST No. 6

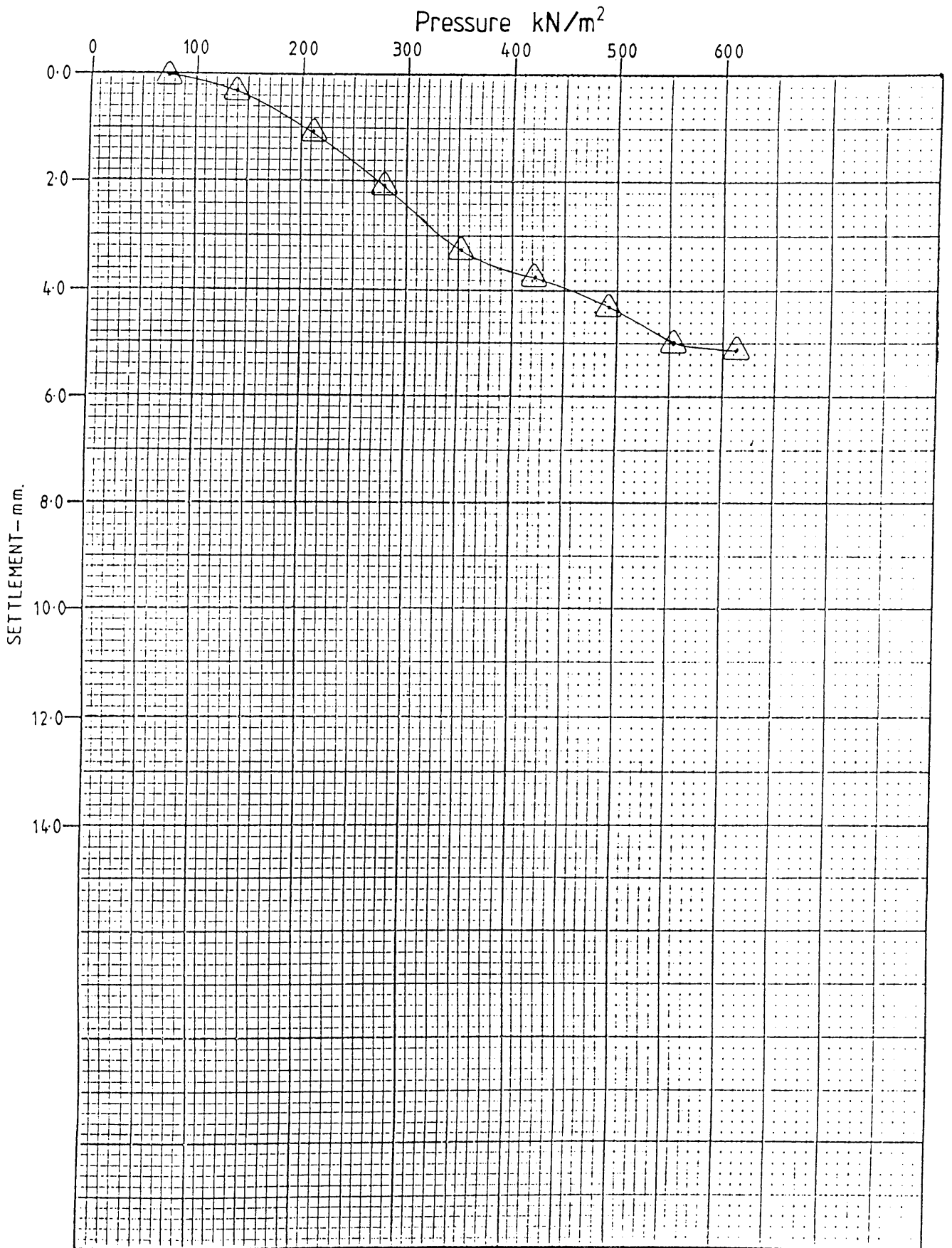

Figure 5.3.30

PLATE LOADING TEST - PRESSURE-SETTLEMENT CURVE

TEST No. 7

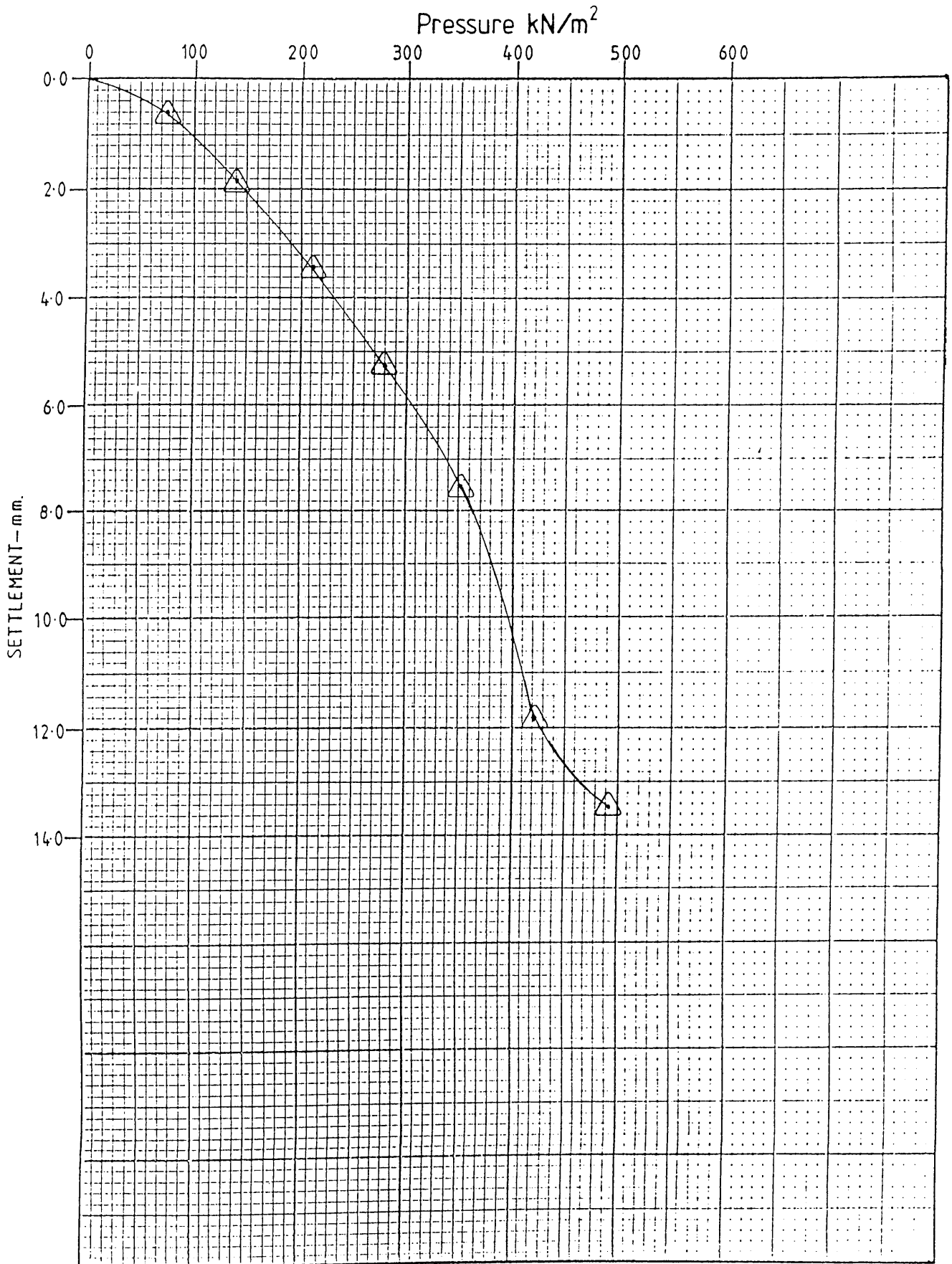

Figure 5.3.31.

PLATE LOADING TEST - PRESSURE-SETTLEMENT CURVE

TEST No. 9

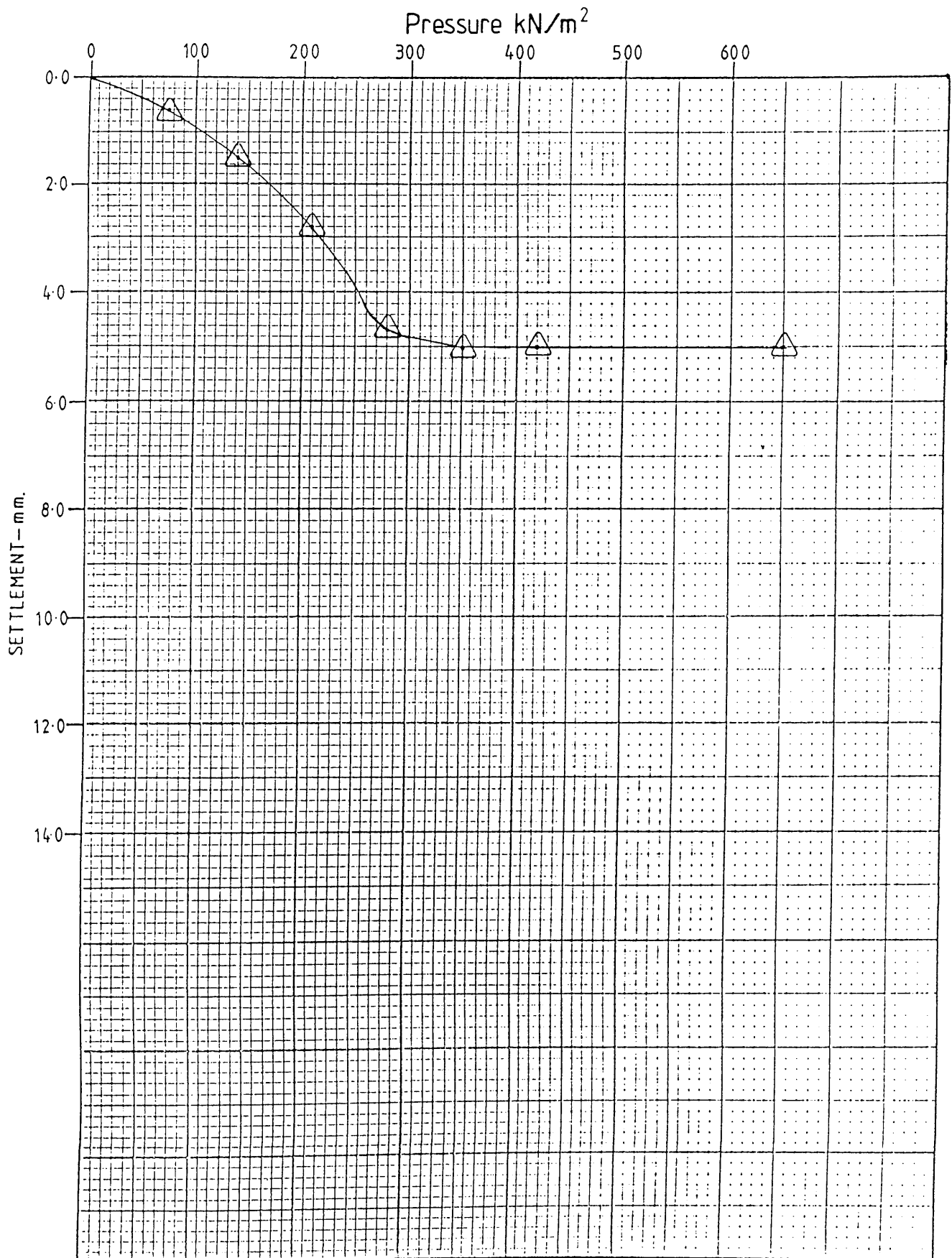

Figure 5.3.32.

PLATE LOADING TEST - PRESSURE - SETTLEMENT CURVE

TEST No. 10

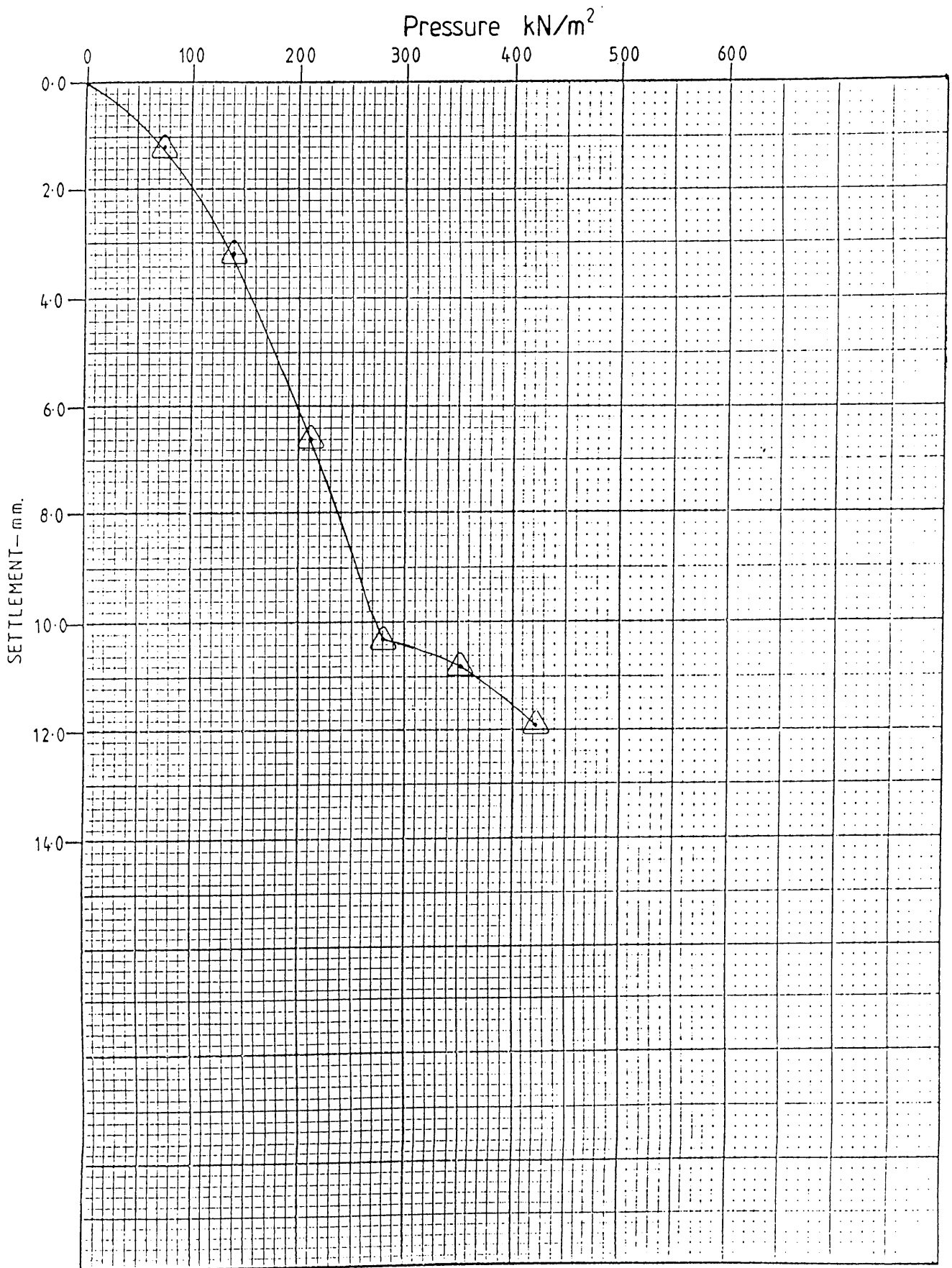

Figure 5.3.33.



Aston University

**Content has been removed for copyright reasons**

YOUNGS MODULUS AGAINST INCREASE IN PRESSURE.

FIGURE 5.3.34.



Aston University

**Content has been removed for copyright reasons**

BOREHOLE LOG - HURST.

E1

FIGURE 5.3.35.



Aston University

**Content has been removed for copyright reasons**

BOREHOLE LOG - HURST.

E1

FIGURE 5.3.36.



Aston University

**Content has been removed for copyright reasons**

BOREHOLE LOG - HURST.

E1

FIGURE 5.3.37





Aston University

**Content has been removed for copyright reasons**

BOREHOLE LOG - HURST.

E2

FIGURE 5.3.38



Aston University

**Content has been removed for copyright reasons**

BOREHOLE LOG - HURST.

E2

FIGURE 5.3.39.



Aston University

**Content has been removed for copyright reasons**

BOREHOLE LOG - HURST.

E2

FIGURE 5.3.40.

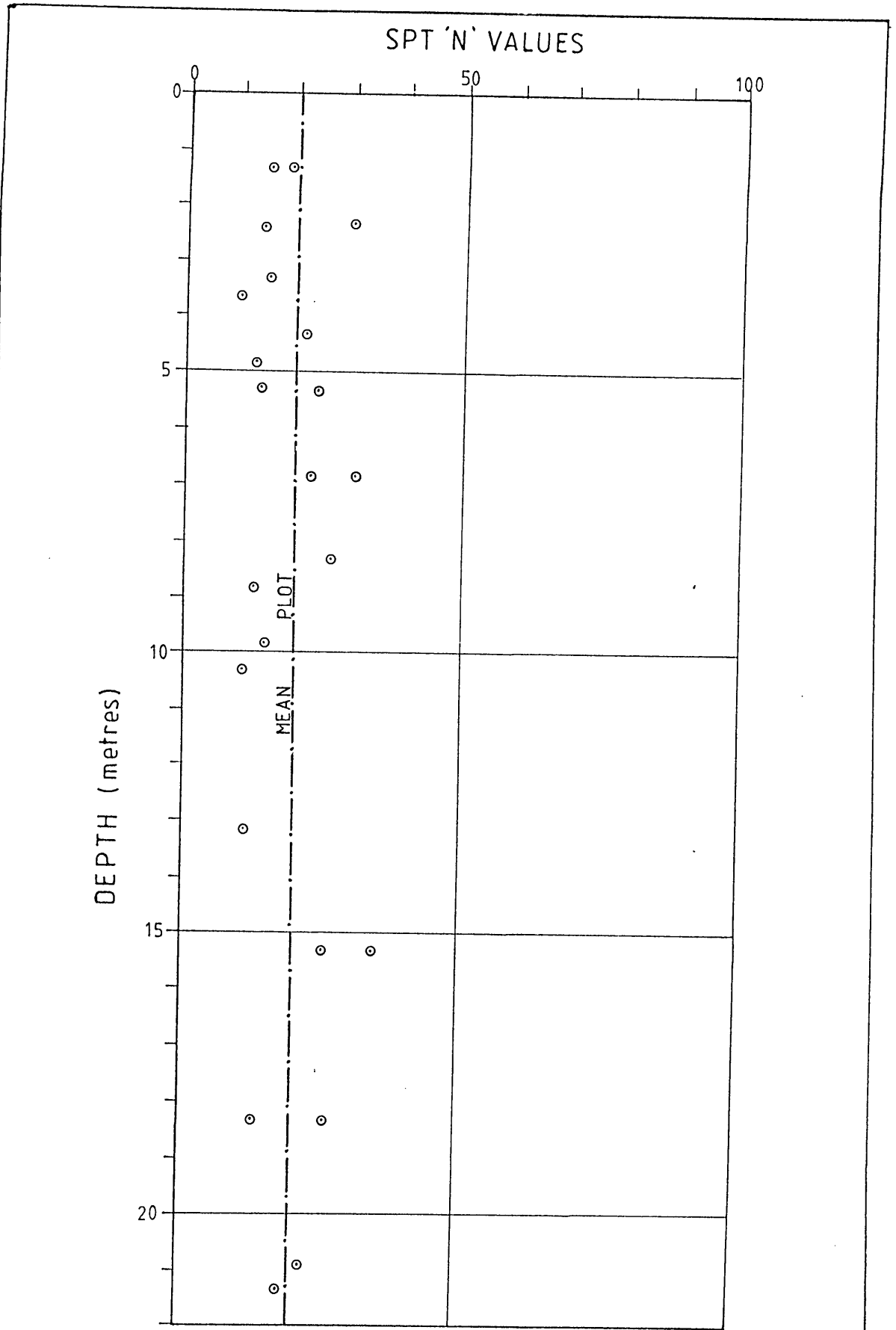

PLOT OF N VALUES AGAINST DEPTH - HURST.

FIGURE 5.3.41.

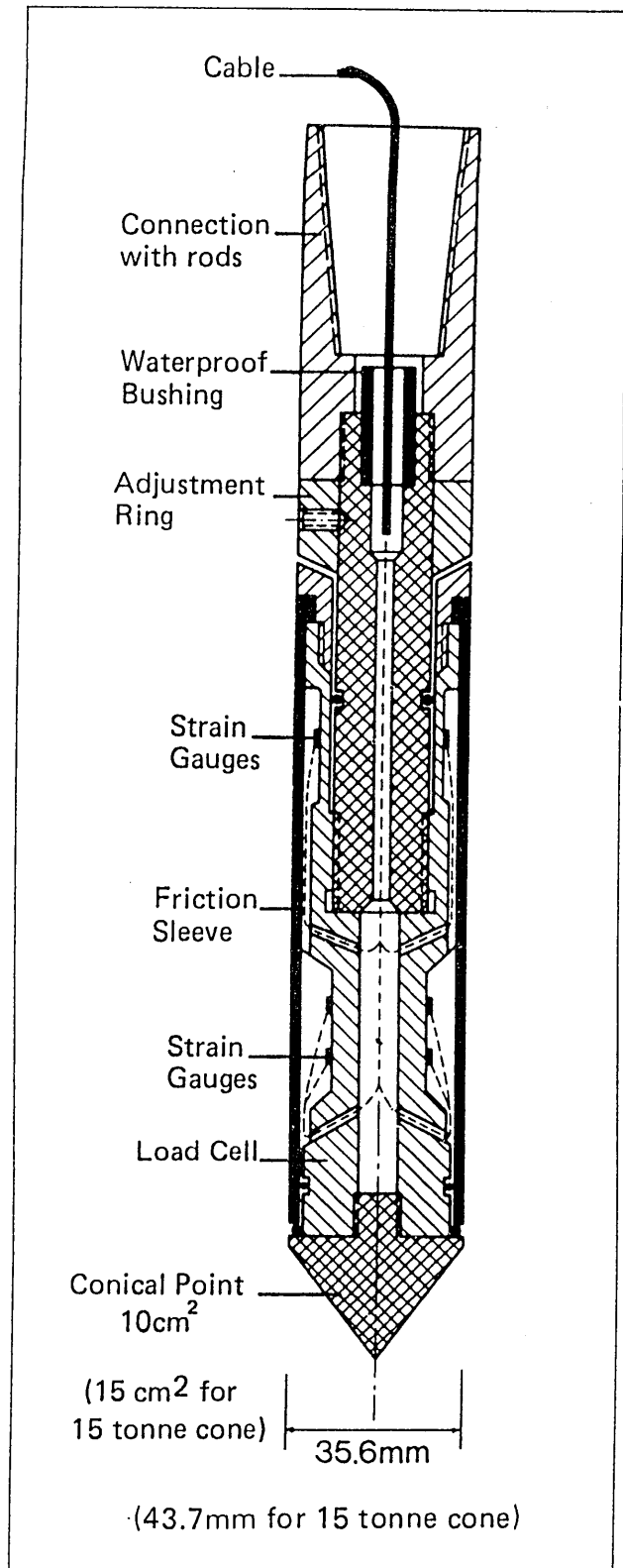

CROSS SECTION OF FUGRO FRICTION CONE.

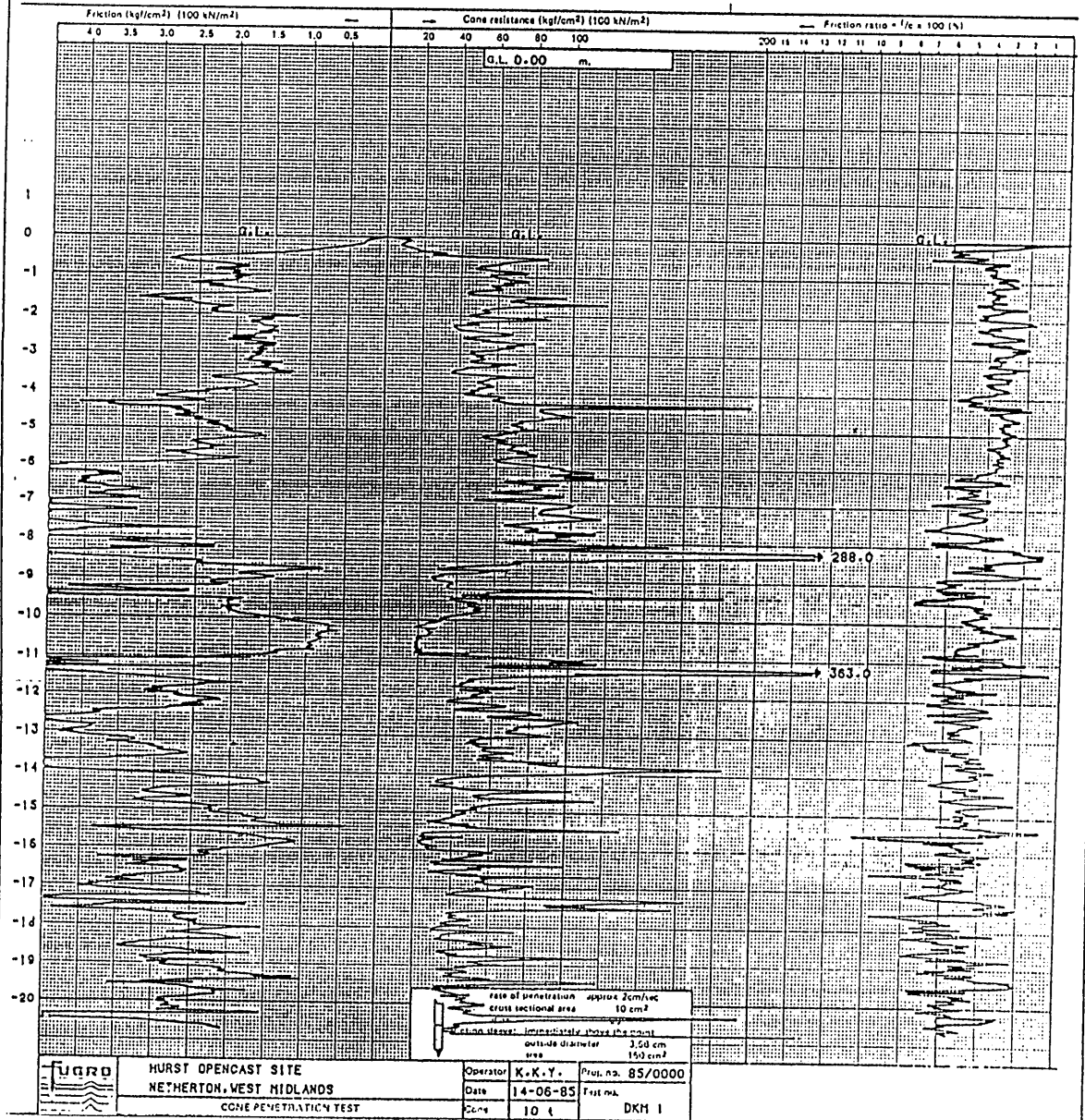

STATIC CONE PENETROMETER LOG - P1.

FIGURE 5.3.43

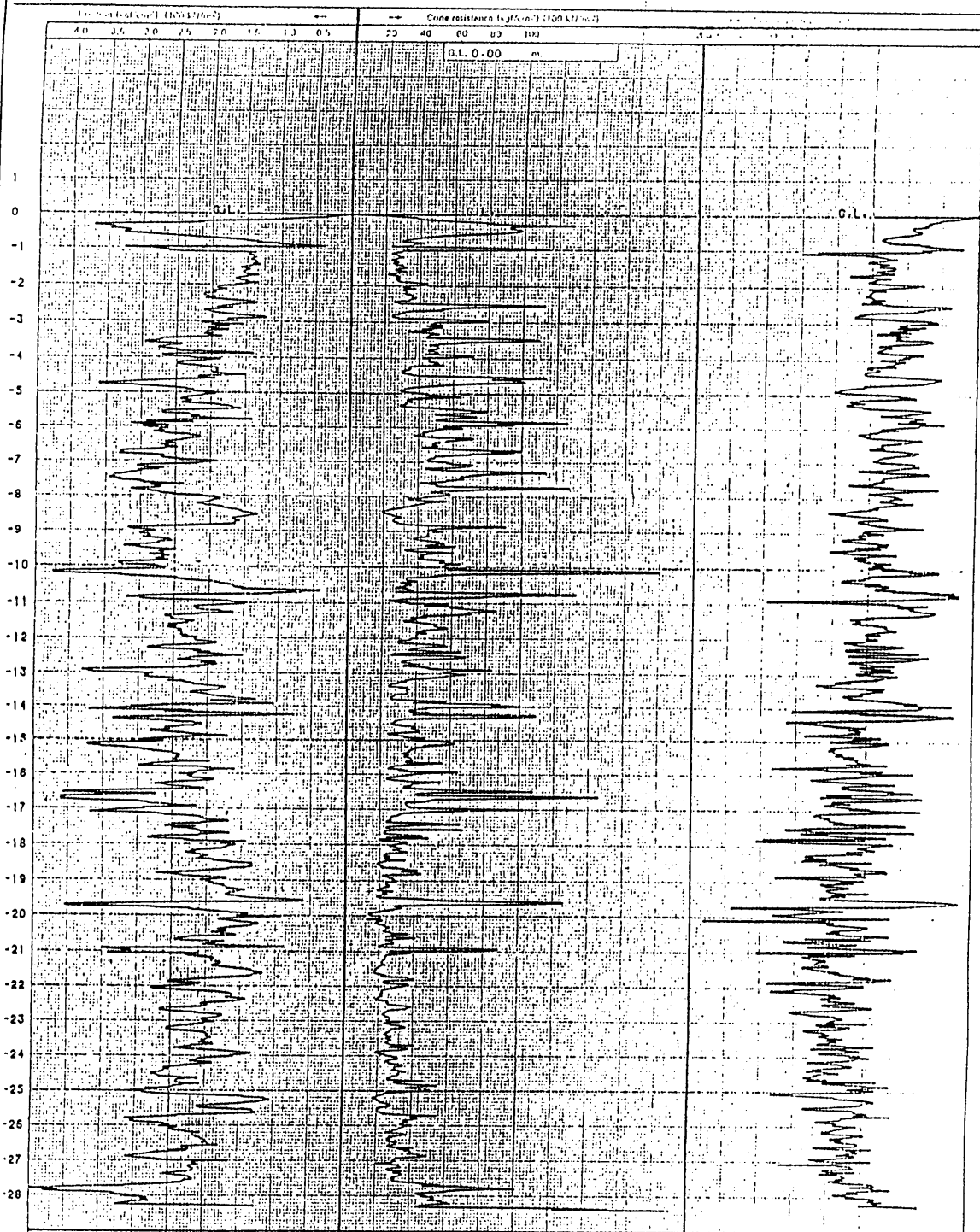

STATIC CONE PENETROMETER LOG - P2.

FIGURE 5.3.44

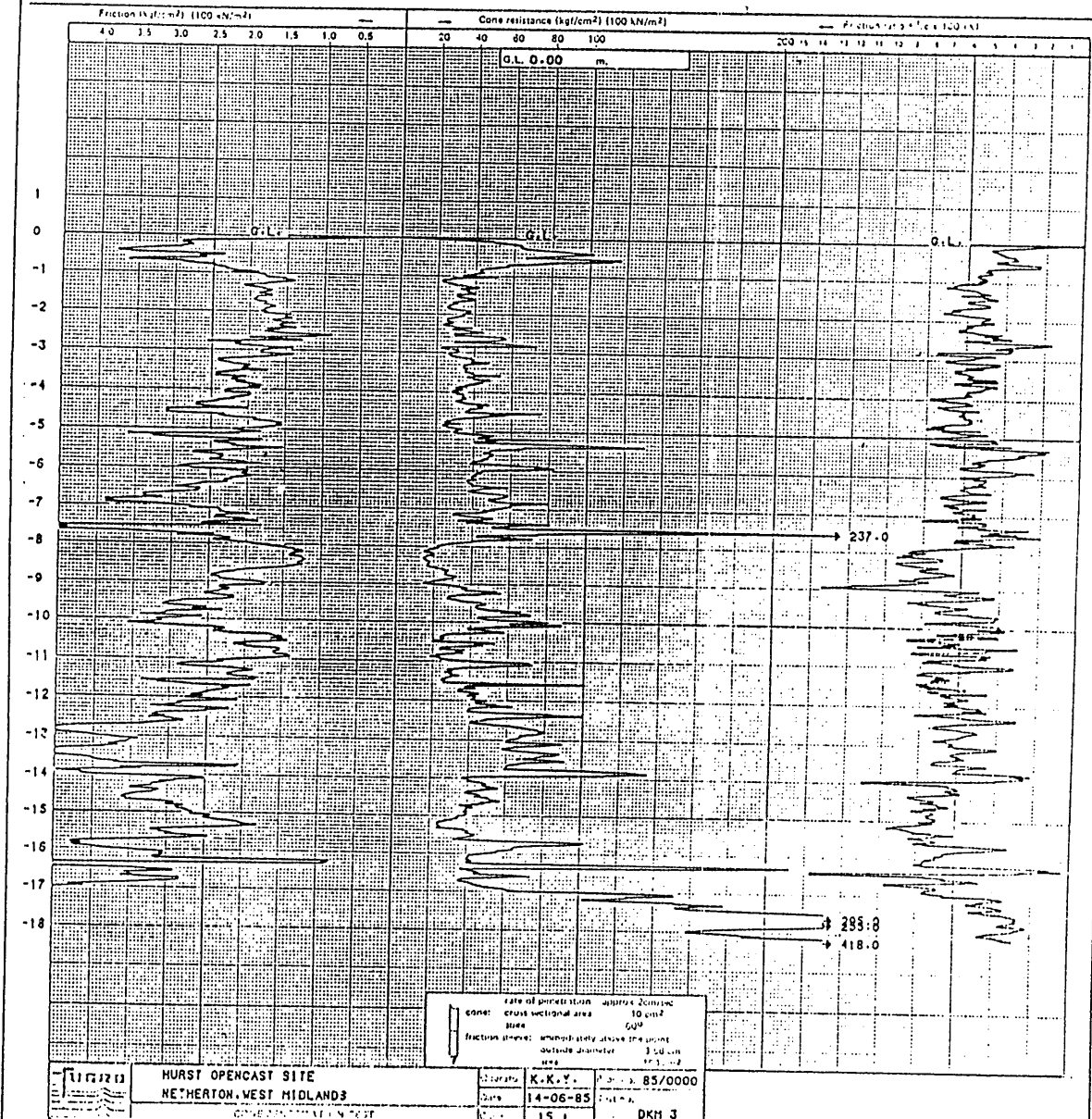

STATIC CONE PENETROMETER LOG - P3.

FIGURE 5.3.45



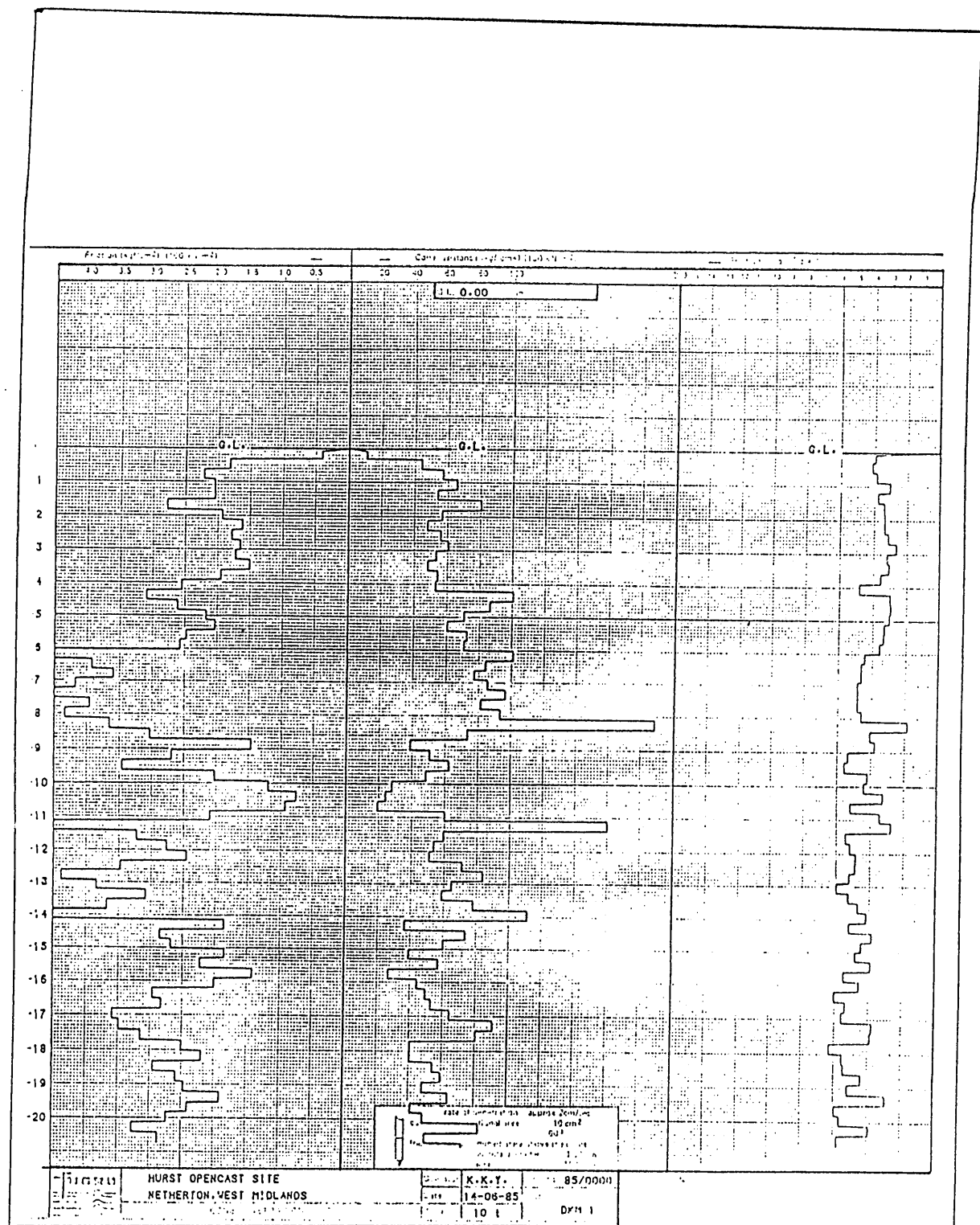

STATIC CONE PENETROMETER LOG - P.1.

FIGURE 5-3-46.

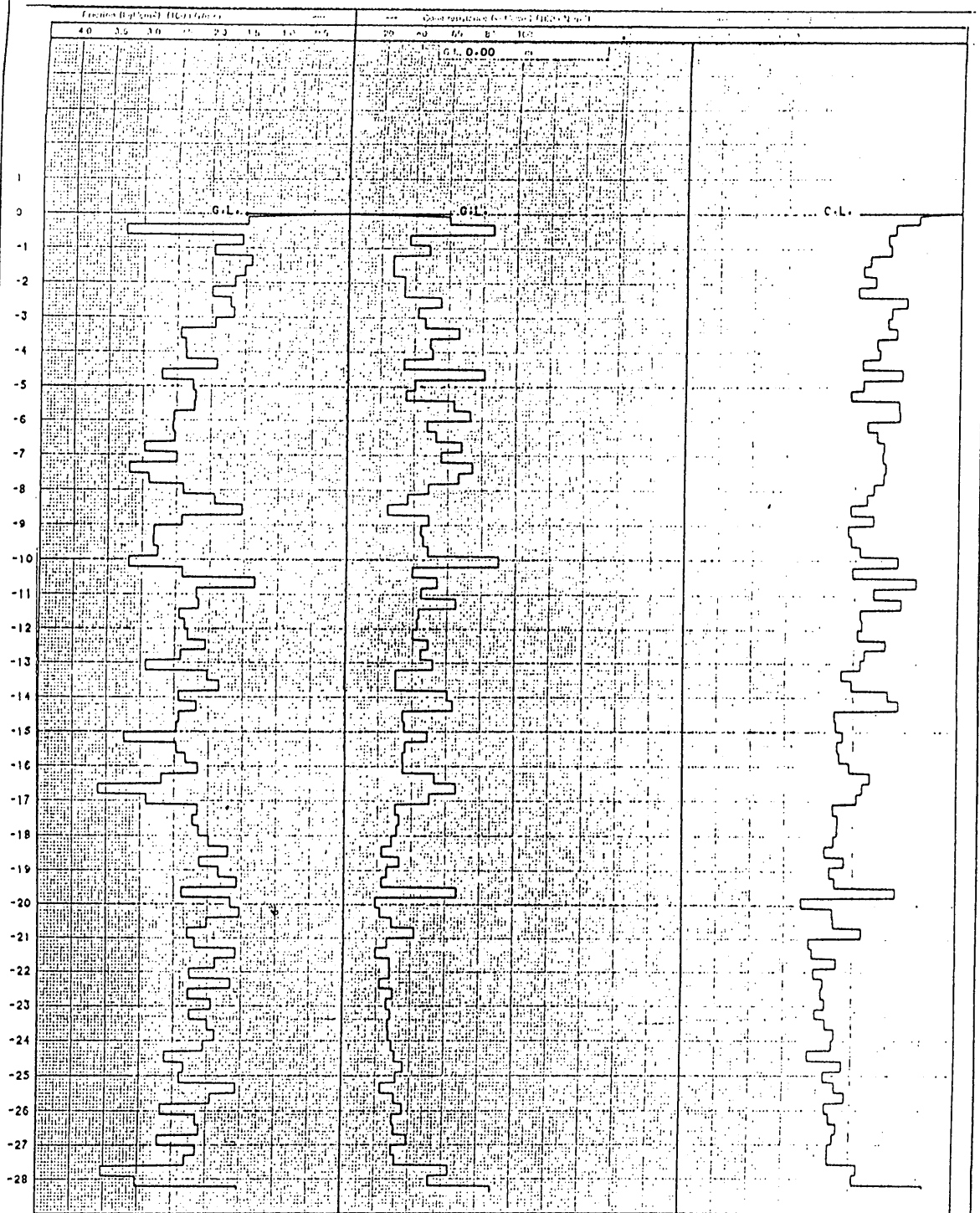

STATIC CONE PENETROMETER LOG - P2.

FIGURE 5-3-47.

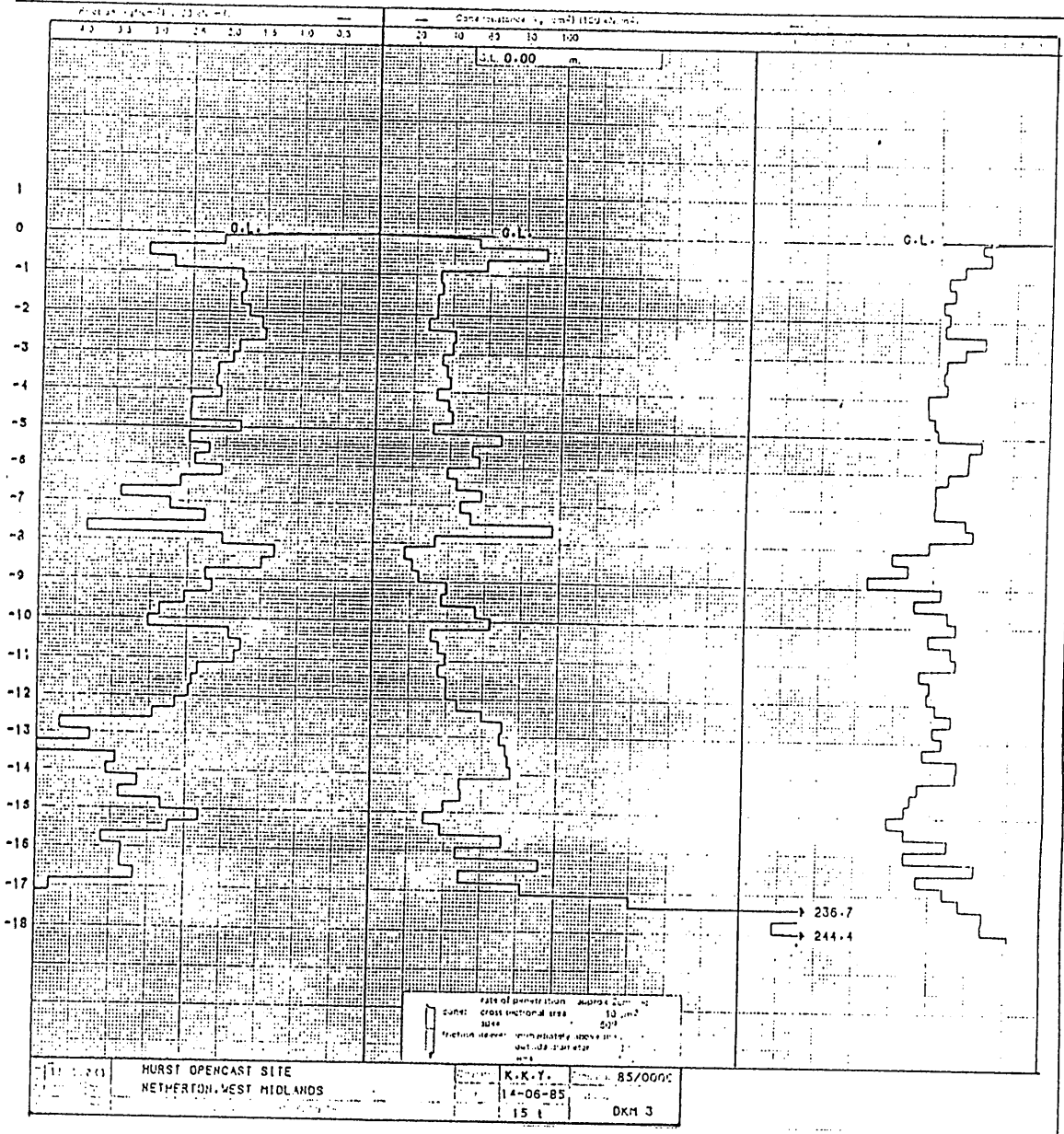

STATIC CONE PENETROMETER LOG - P3.

FIGURE 5.3.48.

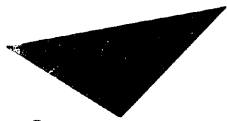

Aston University

**Content has been removed for copyright reasons**

GUIDE FOR ESTIMATING SOIL TYPE.  
(after Schmertman, 1969)

FIGURE 5-3-49.



Aston University

**Content has been removed for copyright reasons**

CORRELATION BETWEEN STATIC CONE AND STANDARD  
PENETRATION TESTS ( Schmertmann, 1970 ).

FIGURE 5-3-50.

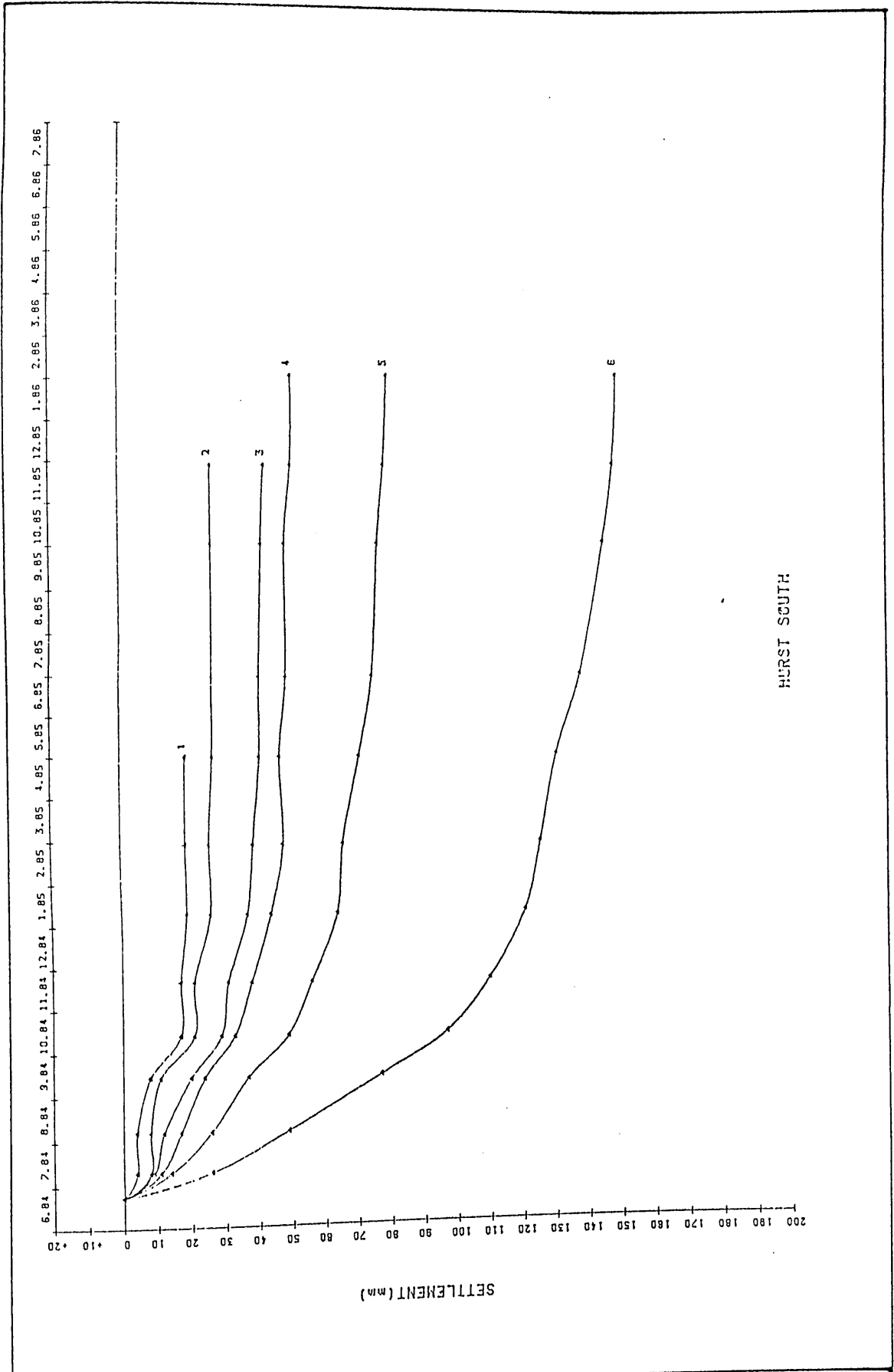

HURST SOUTH

SETTLEMENT v TIME  
SOUTHERN AREA - HURST.

FIGURE 5.3.51.

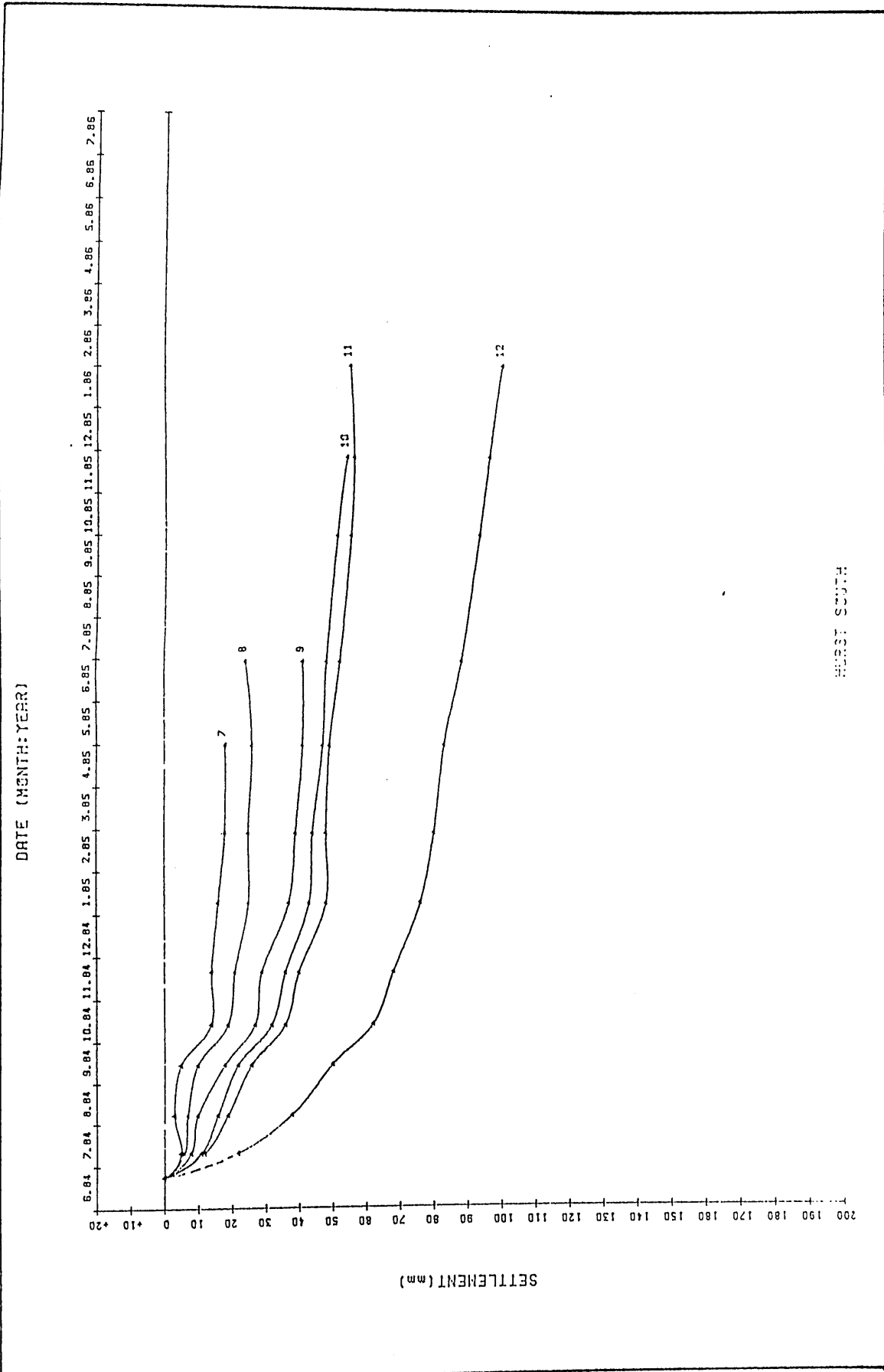

PLACES REFER

SETTLEMENT v TIME  
SOUTHERN AREA - HURST.

FIGURE 5-3-52.

DATE (MONTH:YEAR)

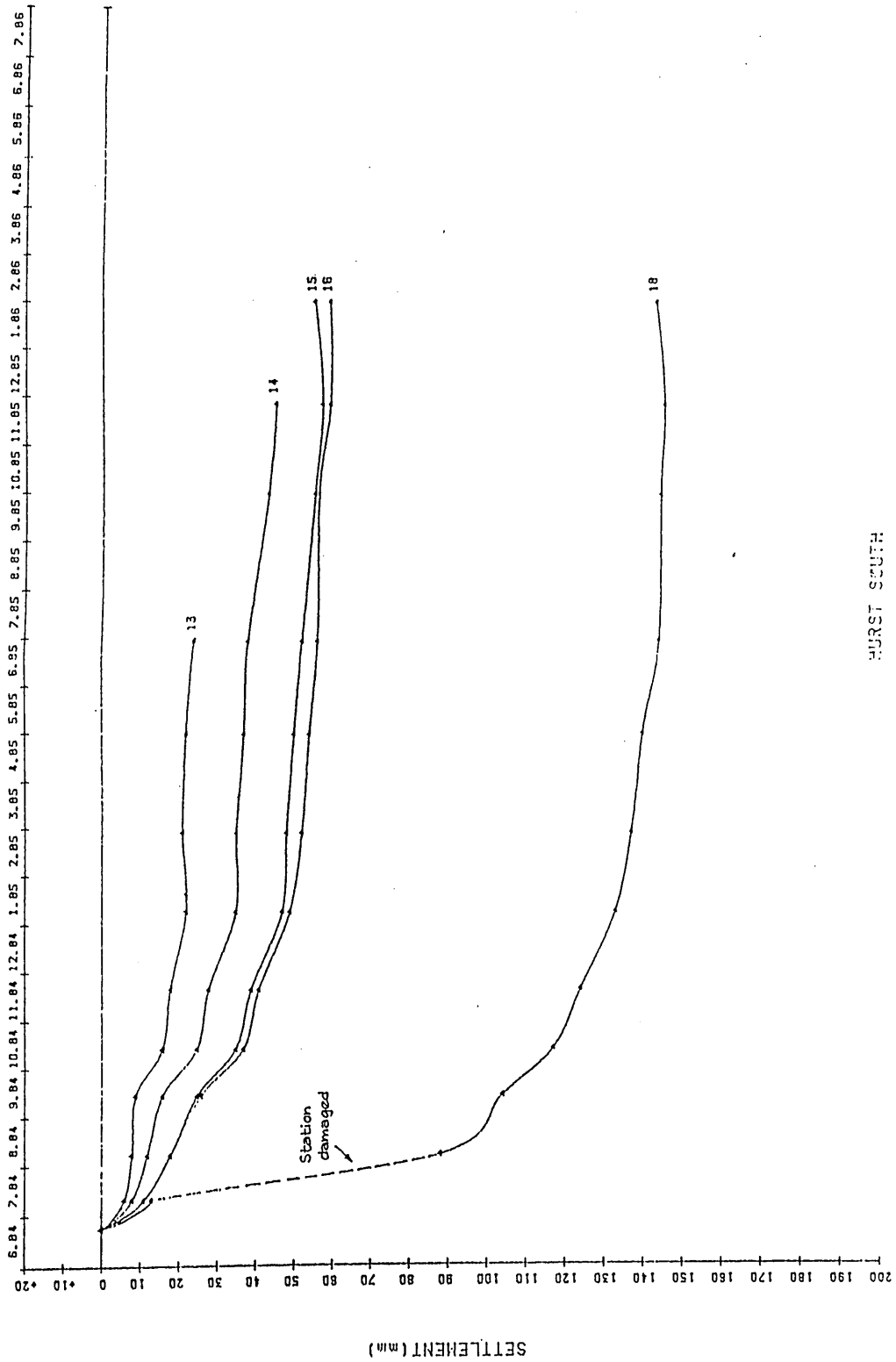

HURST SOUTH

SETTLEMENT v TIME  
SOUTHERN AREA - HURST.

FIGURE 5.3.53.



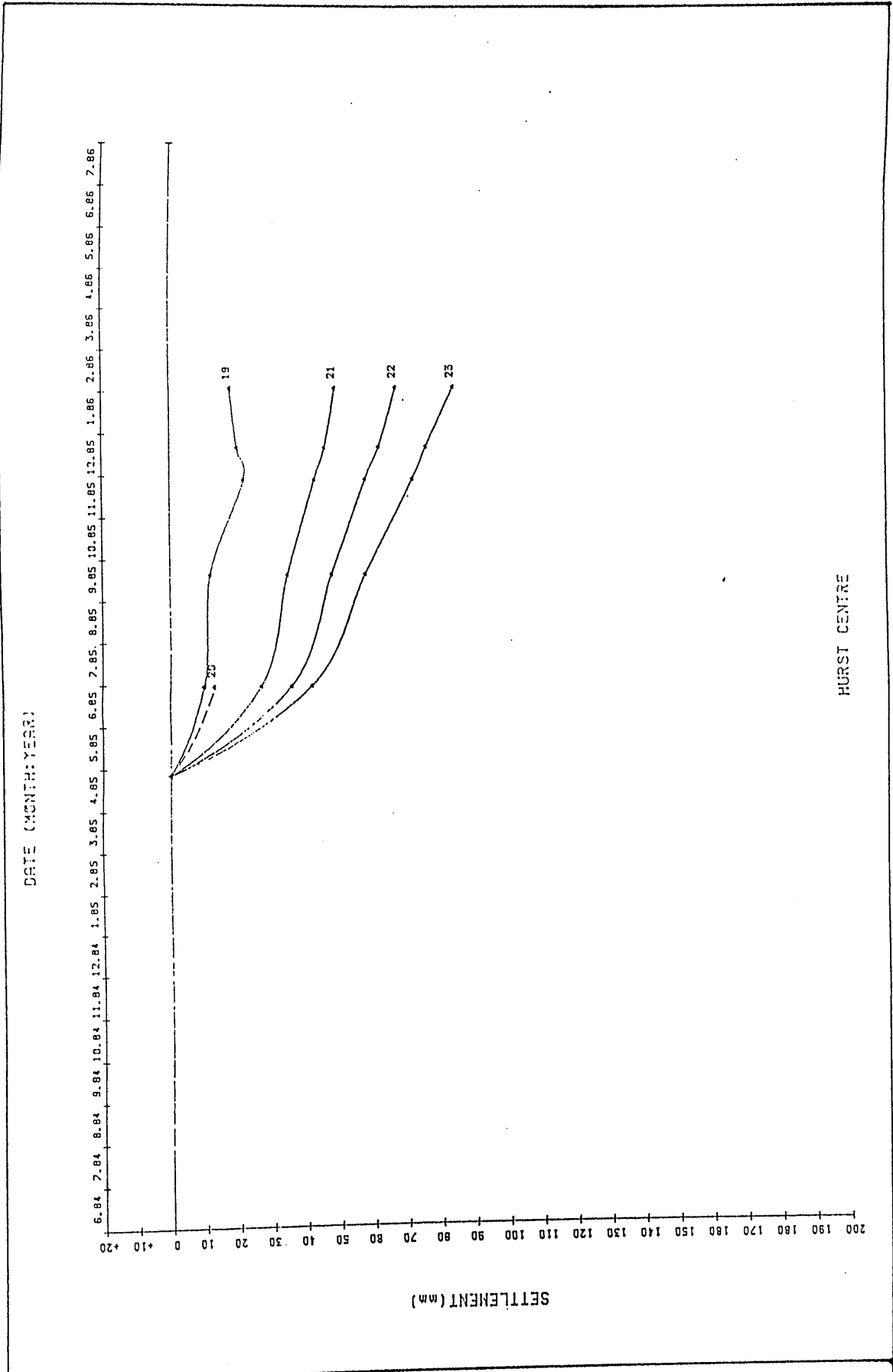

HURST CENTRE

SETTLEMENT v TIME  
CENTRAL AREA HURST.

FIGURE 5-3-54.

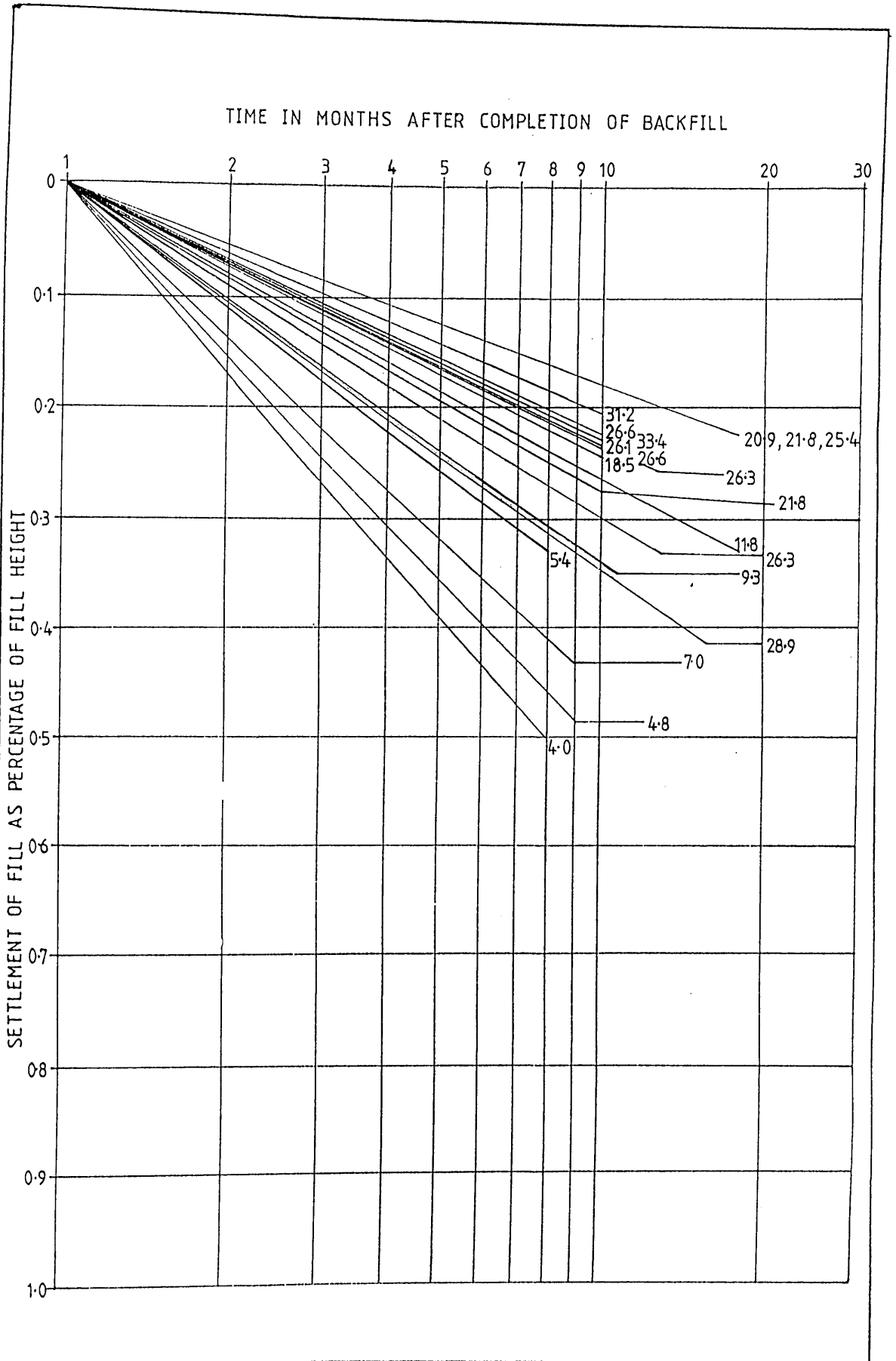

SETTLEMENT ( expressed as percentage of fill height )  
 AGAINST LOGARITHM OF TIME - FOR ALL SETTLEMENT  
 STATIONS.

FIGURE 5-3-55.

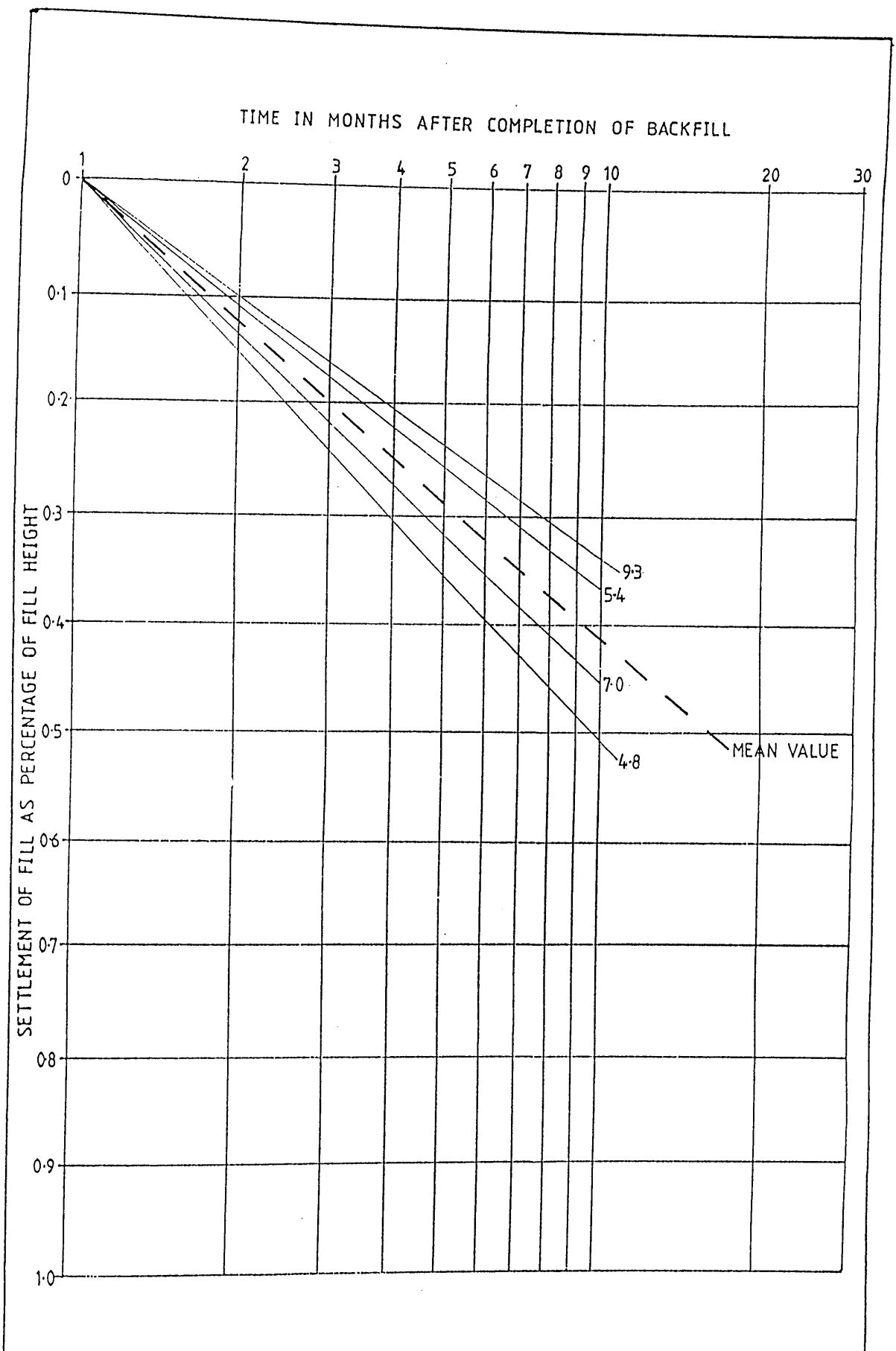

SETTLEMENT (expressed as percentage of fill height.)  
 AGAINST LOGARITHM OF TIME - FILL THICKNESS  
 0-10 metres.

FIGURE 5.3.56.

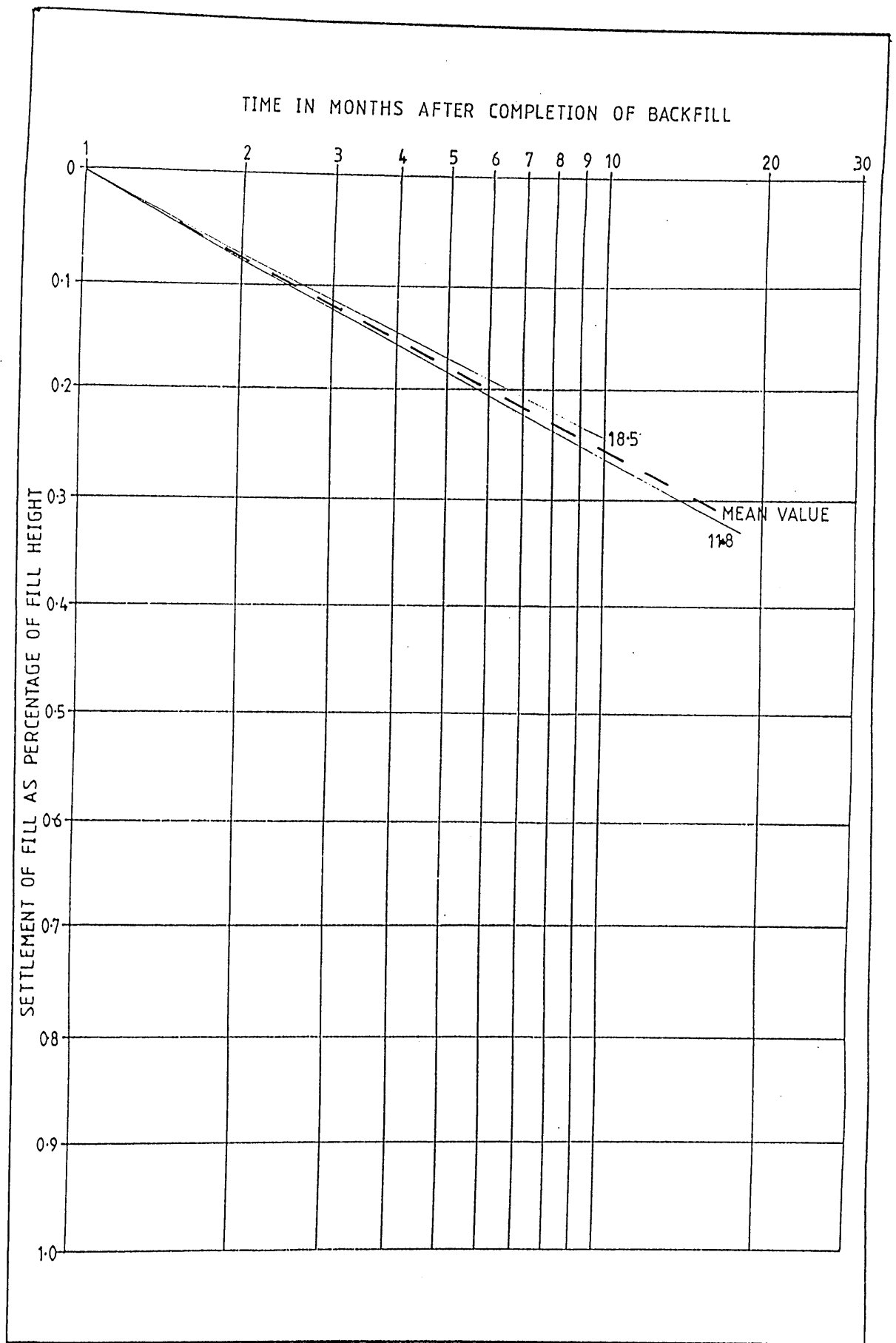

SETTLEMENT (expressed as percentage of fill height)  
 AGAINST LOGARITHM OF TIME - FILL THICKNESS  
 10-20 metres.

FIGURE 5.3.57.

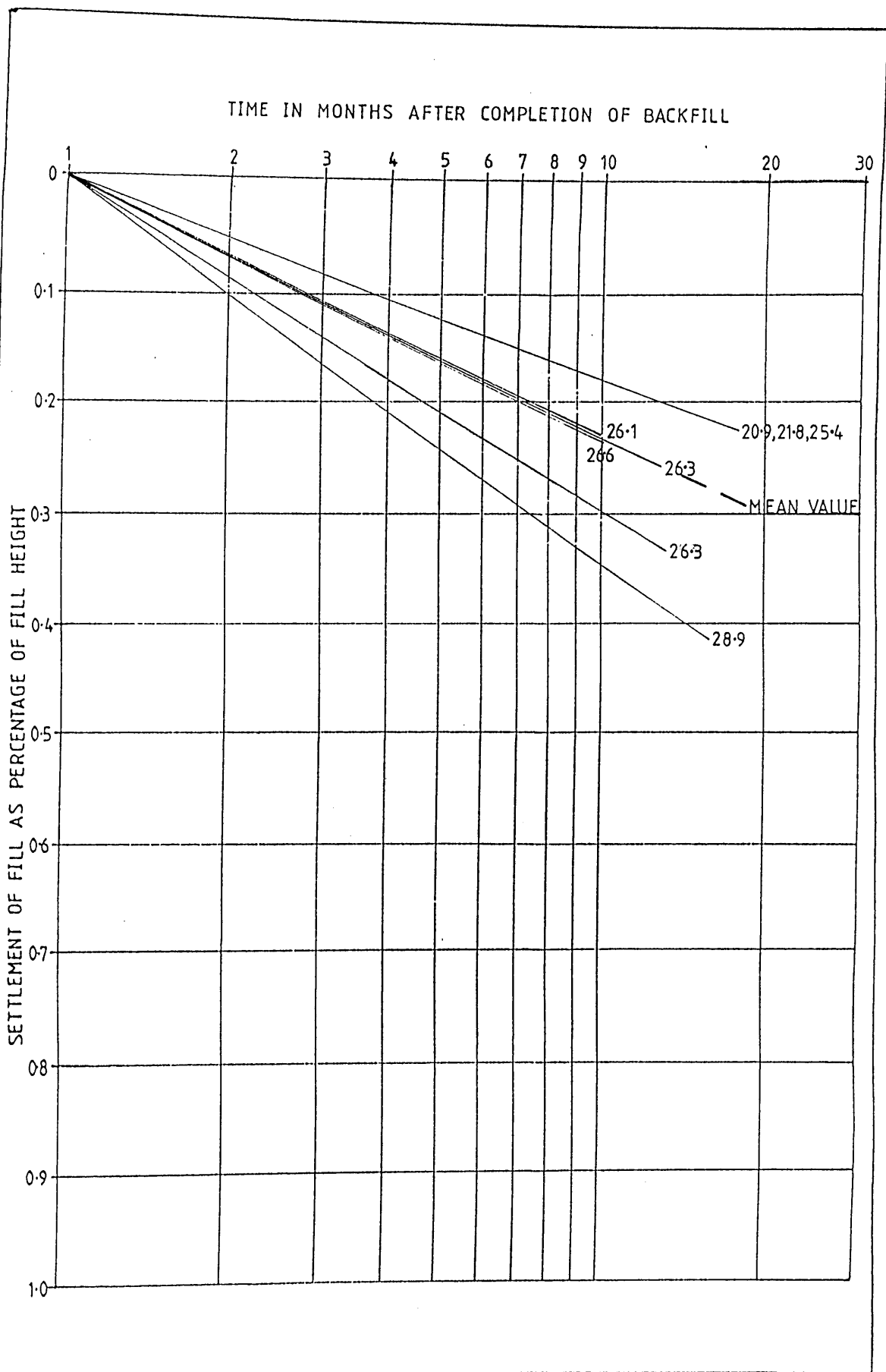

SETTLEMENT (expressed as percentage of fill height)  
 AGAINST LOGARITHM OF TIME - FILL THICKNESS  
 20 - 30 metres.

FIGURE 5.3.58.

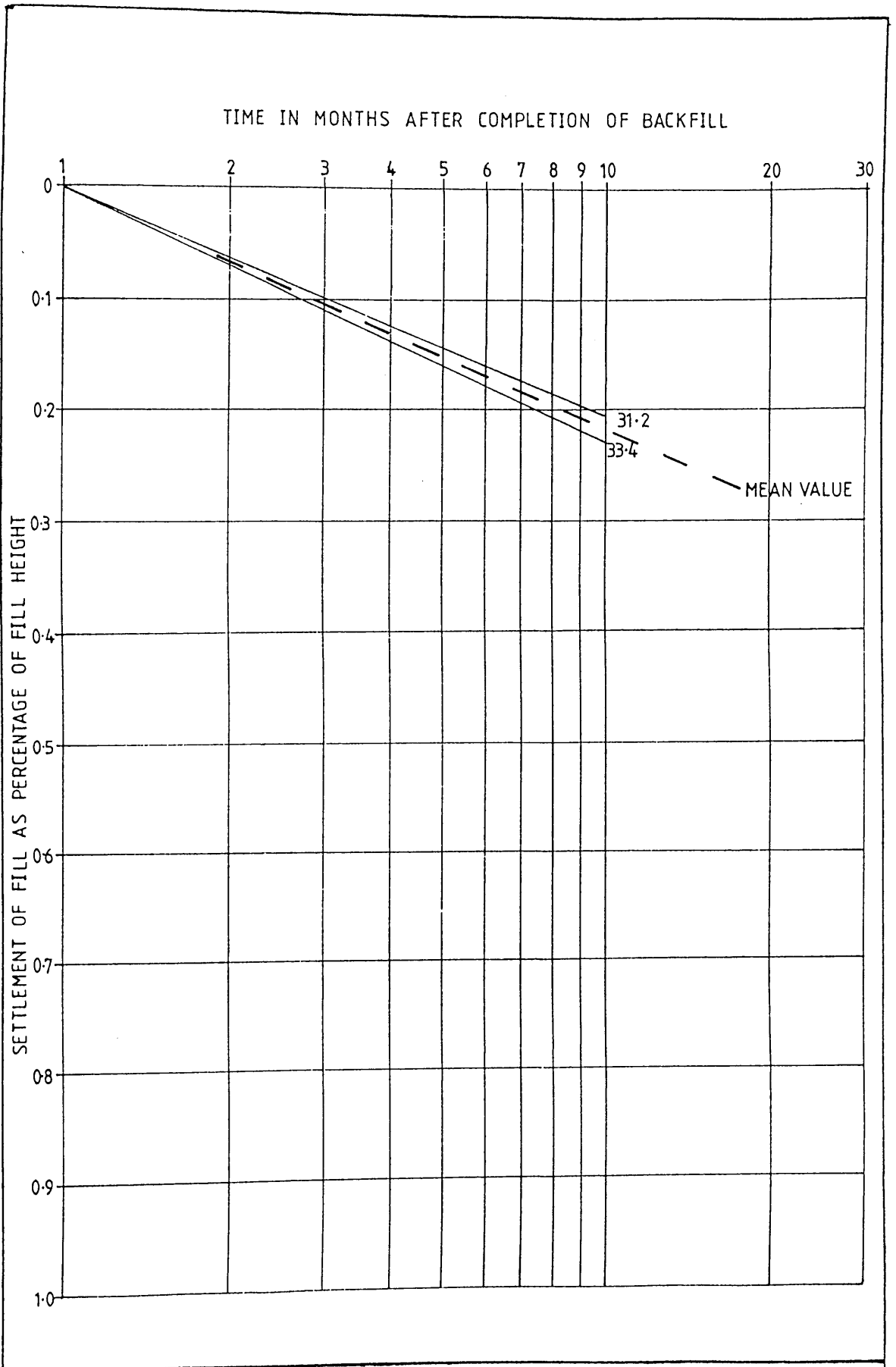

SETTLEMENT ( expressed as percentage of fill height )  
 AGAINST LOGARITHM OF TIME - FILL THICKNESS  
 30-40 metres.

FIGURE 5.3.59.

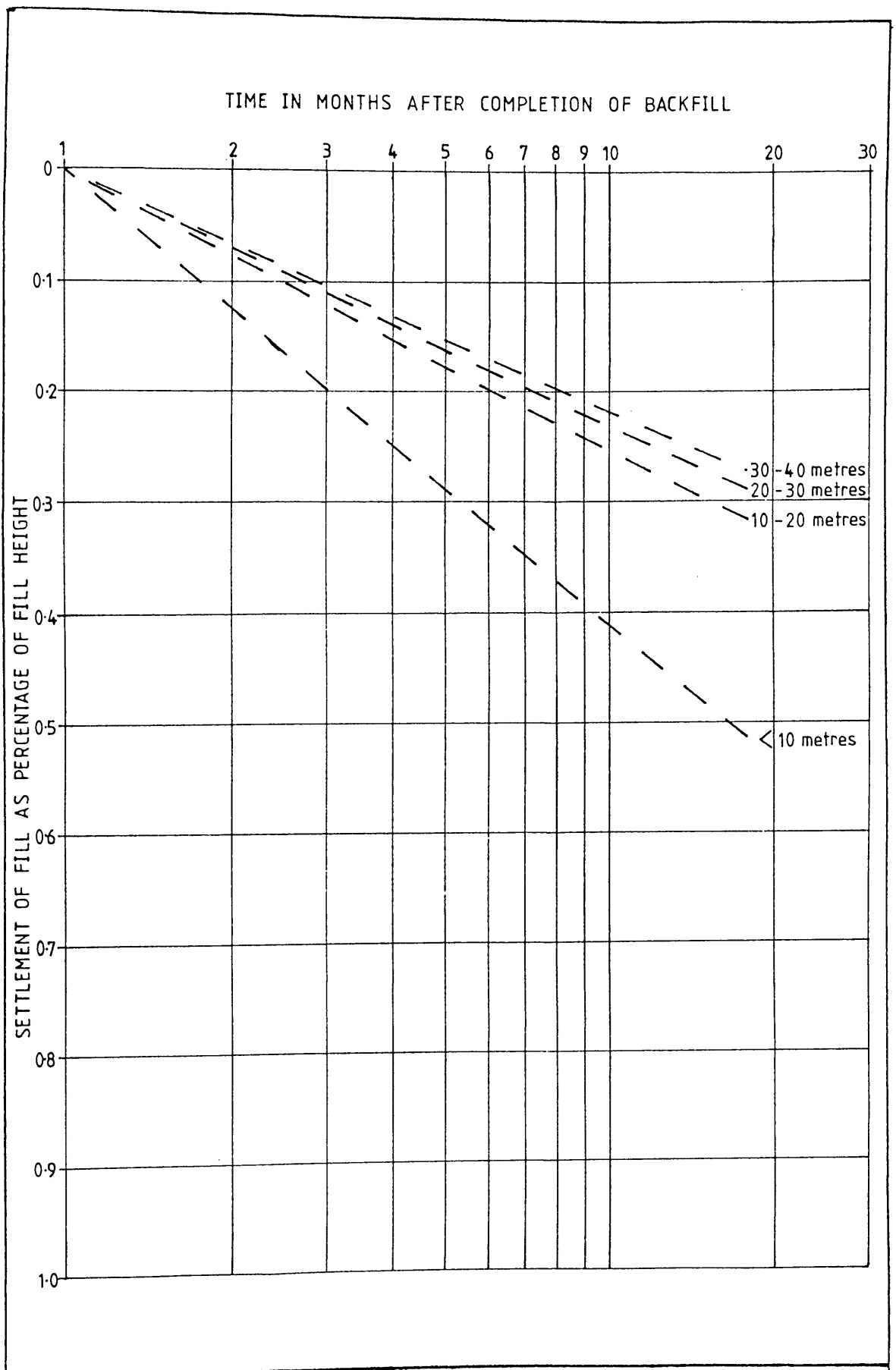

SETTLEMENT (expressed as percentage of fill height)  
 AGAINST LOGARITHM OF TIME - MEAN VALUES FOR  
 FILL THICKNESS RANGE.

FIGURE 5.3.60.

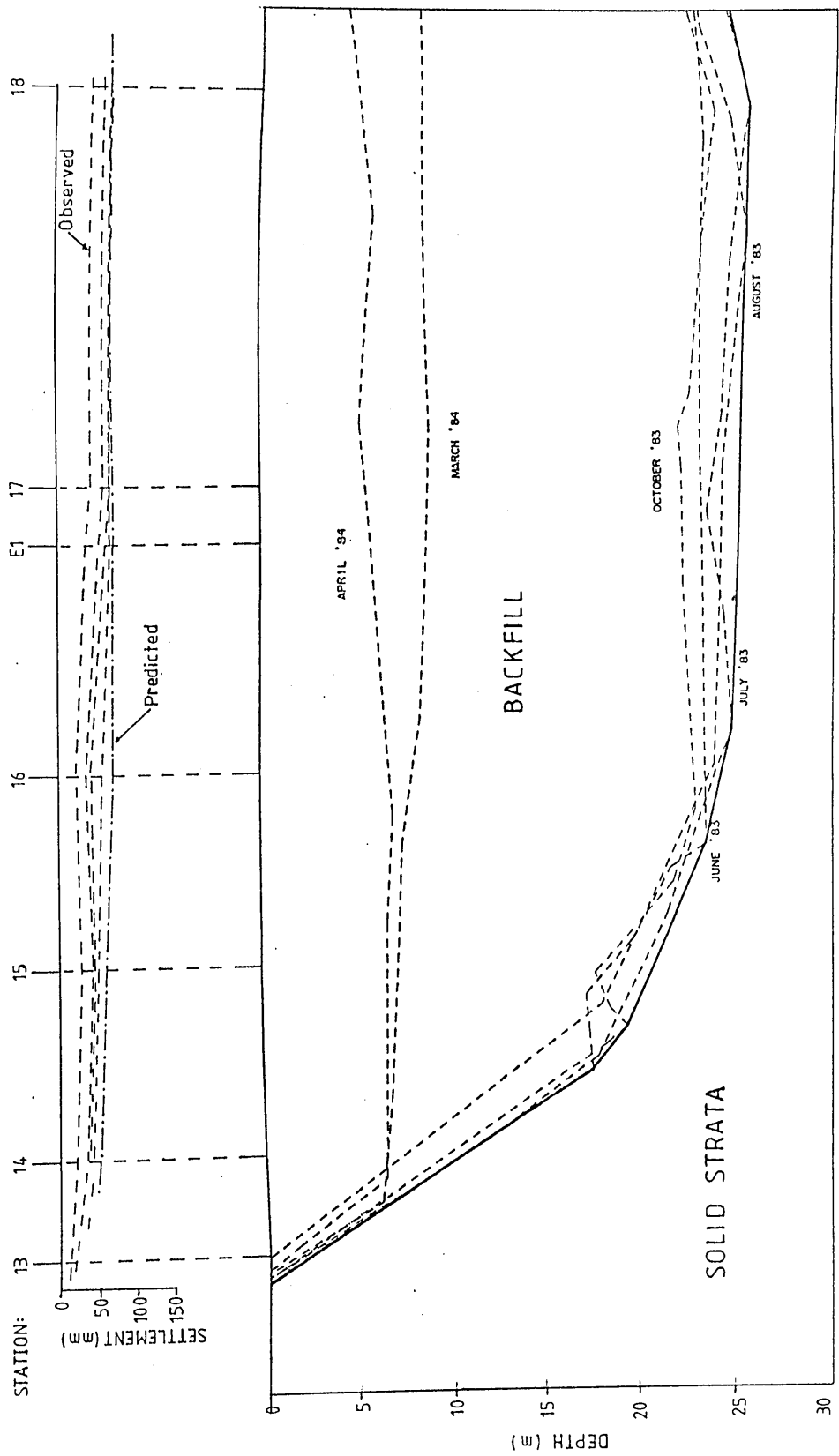

SECTION H1 - HURST  
 SETTLEMENT AND EXCAVATION PROFILES.

FIGURE 5.3.61.



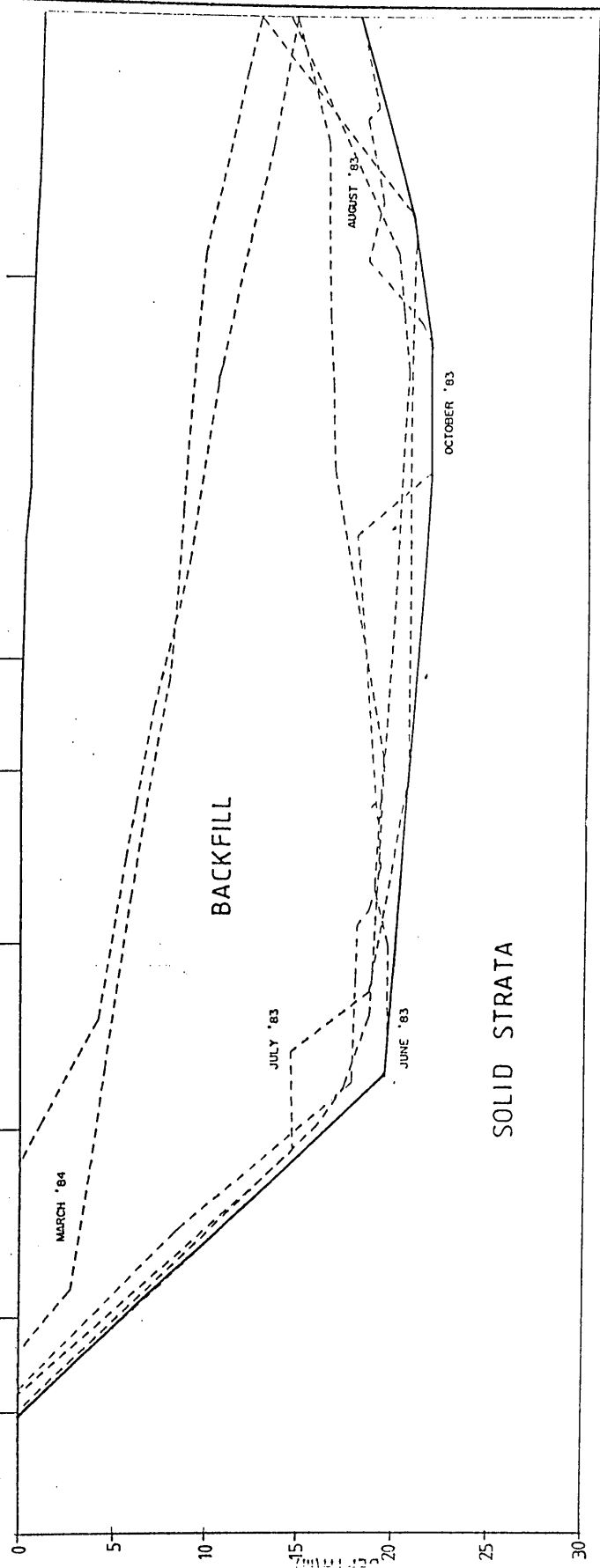
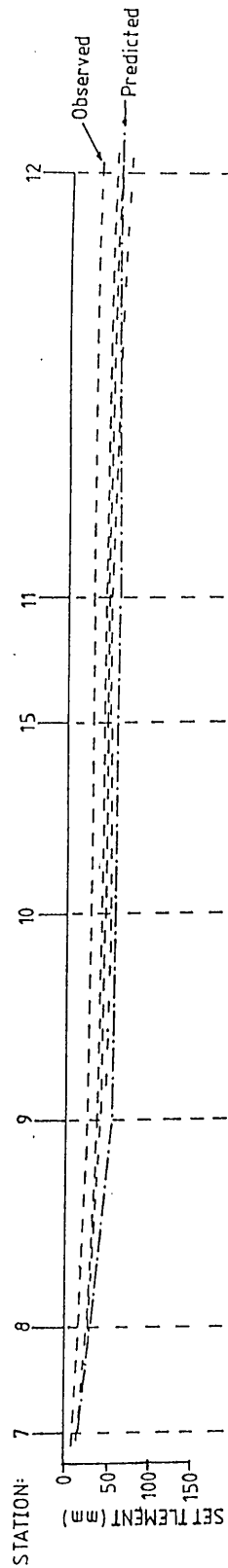

SECTION H2 - HURST  
 SETTLEMENT AND EXCAVATION PROFILES.

FIGURE 5-3-62.

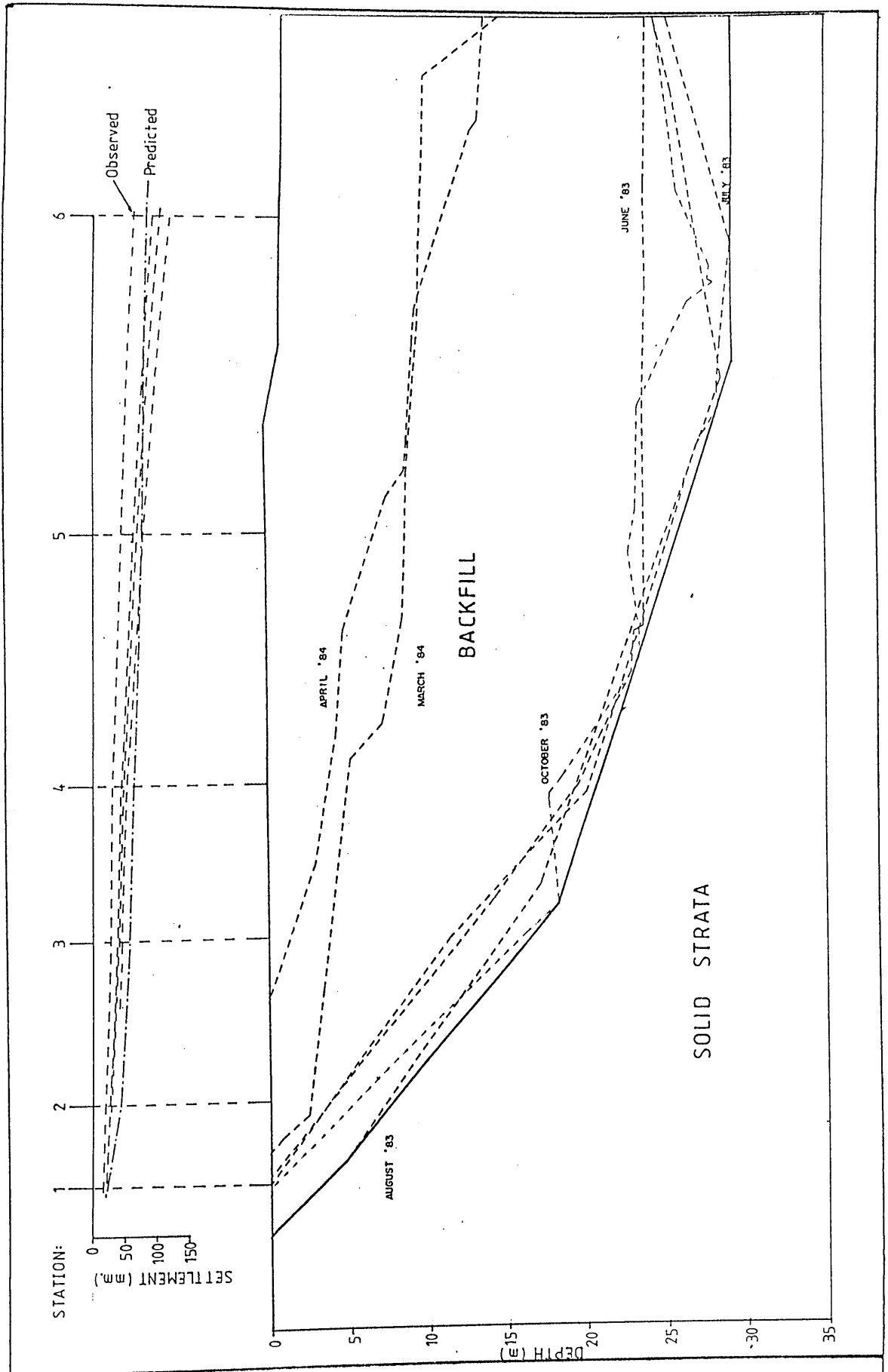

SECTION H3 - HURST  
SETTLEMENT AND EXCAVATION PROFILES.

FIGURE 5.3.63.

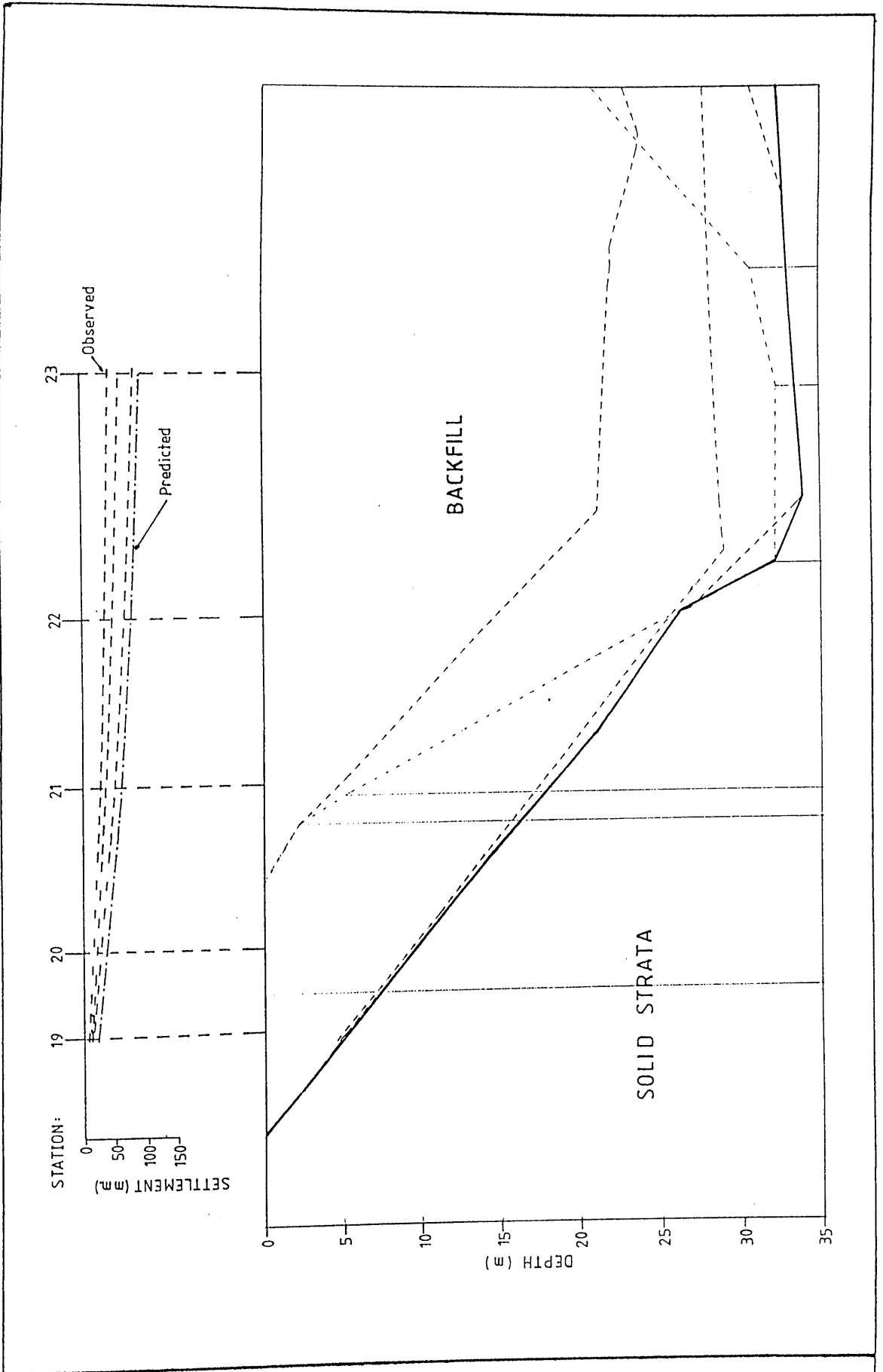

SECTION H4 - HURST  
 SETTLEMENT AND EXCAVATION PROFILES.

FIGURE 5.3.64

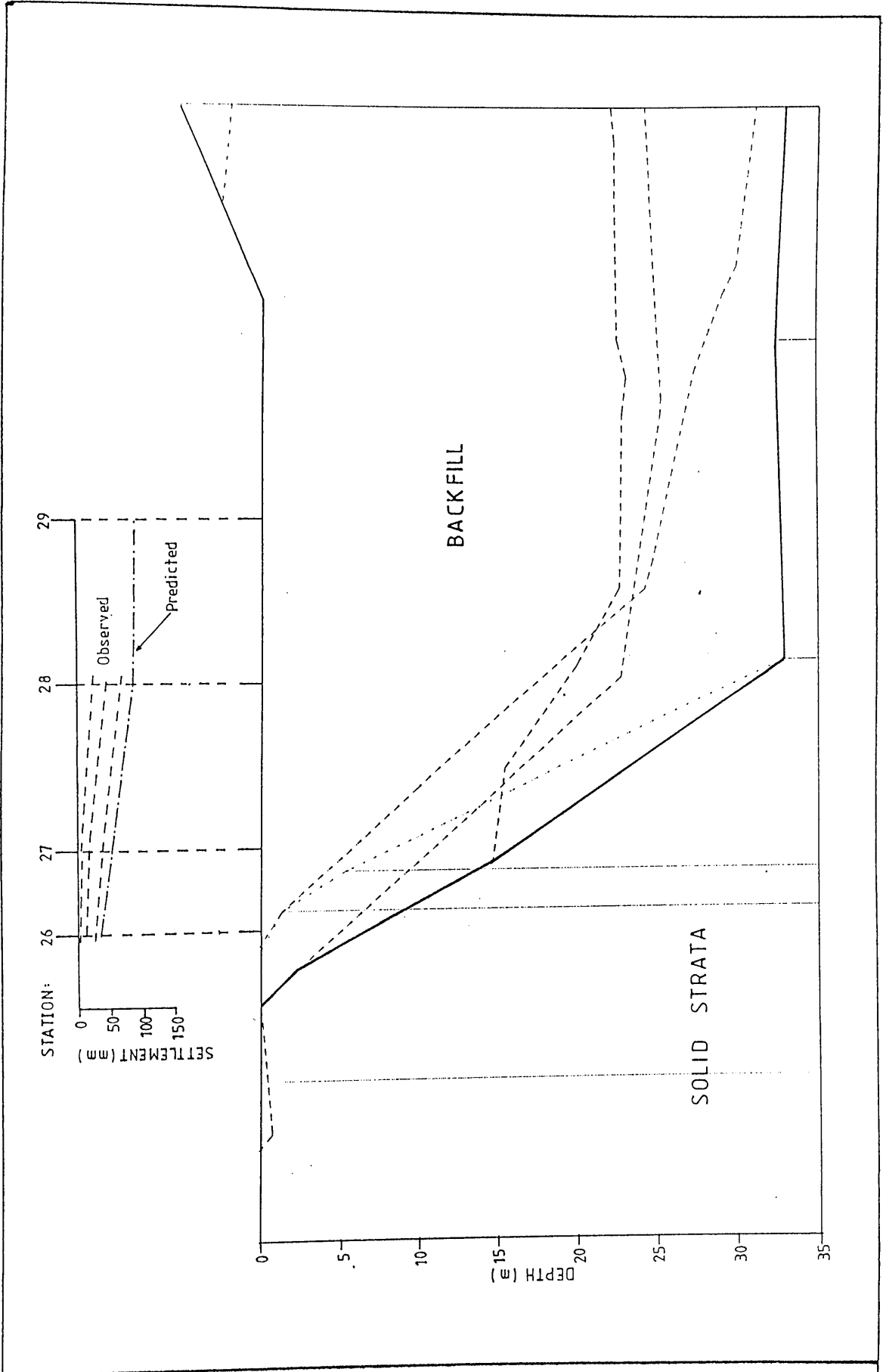

SECTION H5 - HURST  
 SETTLEMENT AND EXCAVATION PROFILES.

FIGURE 5.3.65.

DATE (MONTH:YEAR)

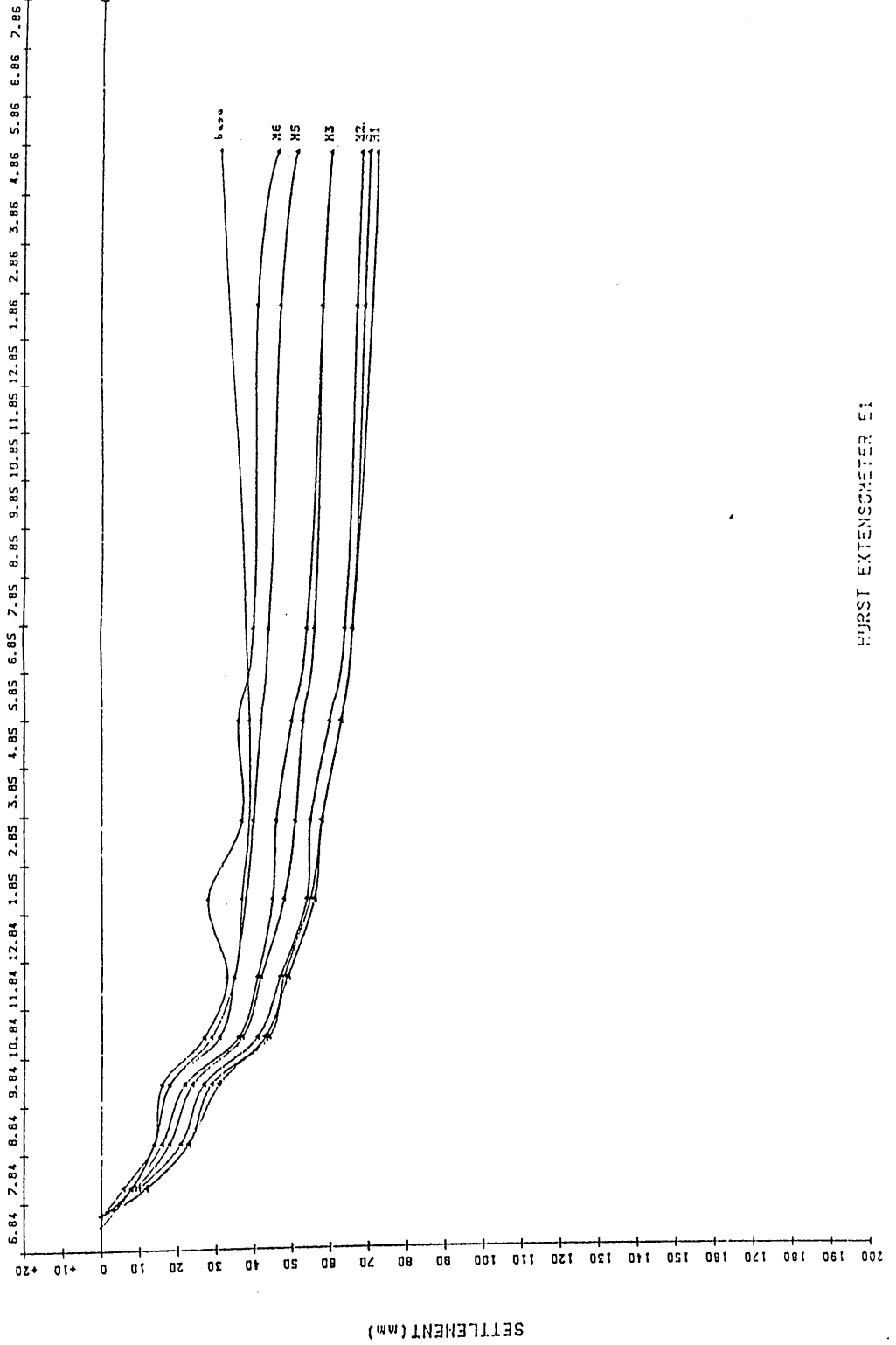

HURST EXTENSOMETER E1

SETTLEMENT v TIME  
SOUTHERN AREA - HURST.

FIGURE 5-3-66.

DATE (MONTH:YEAR)

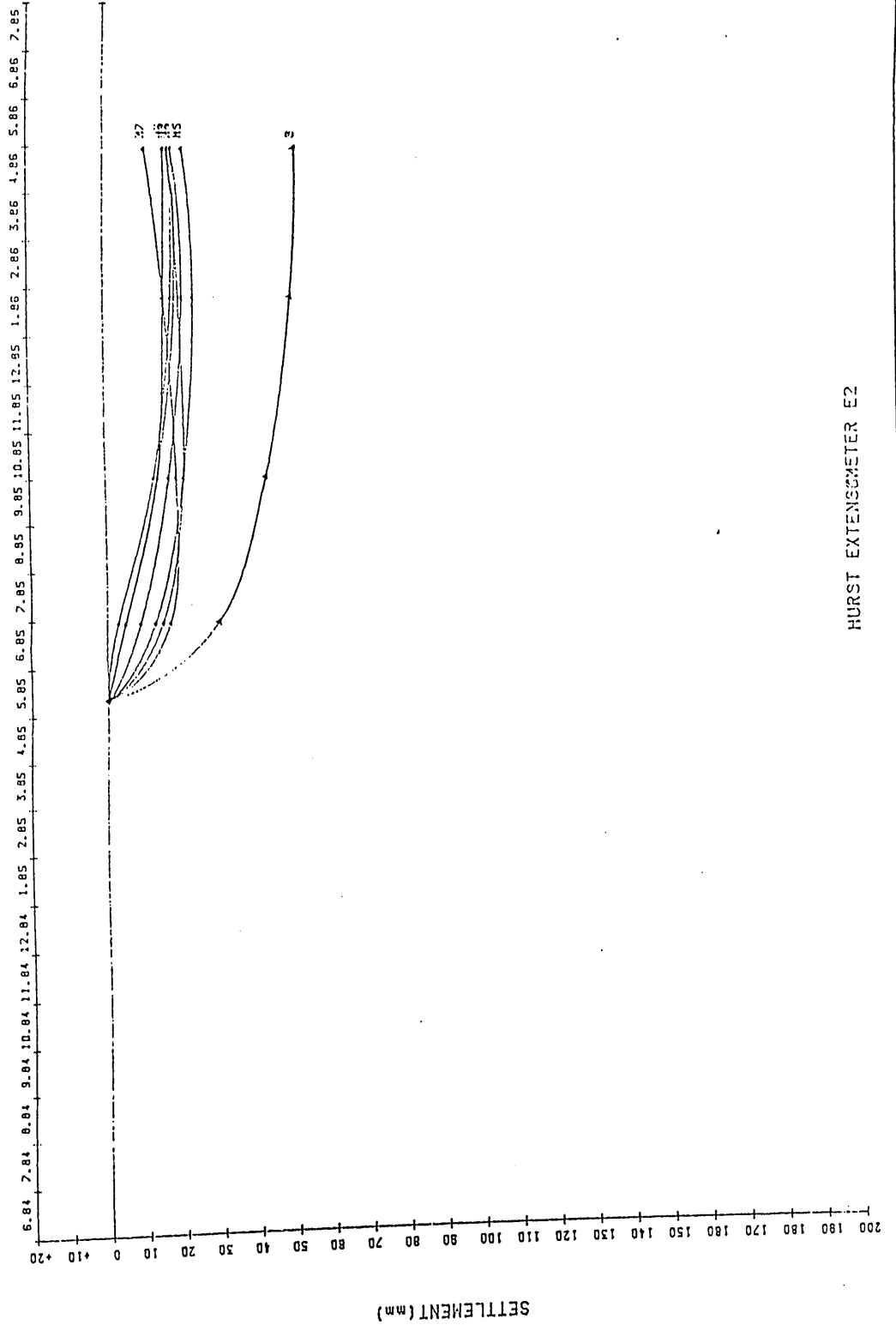

HURST EXTENSOMETER E2

SETTLEMENT v TIME  
CENTRAL AREA HURST.

FIGURE 5.3.67.

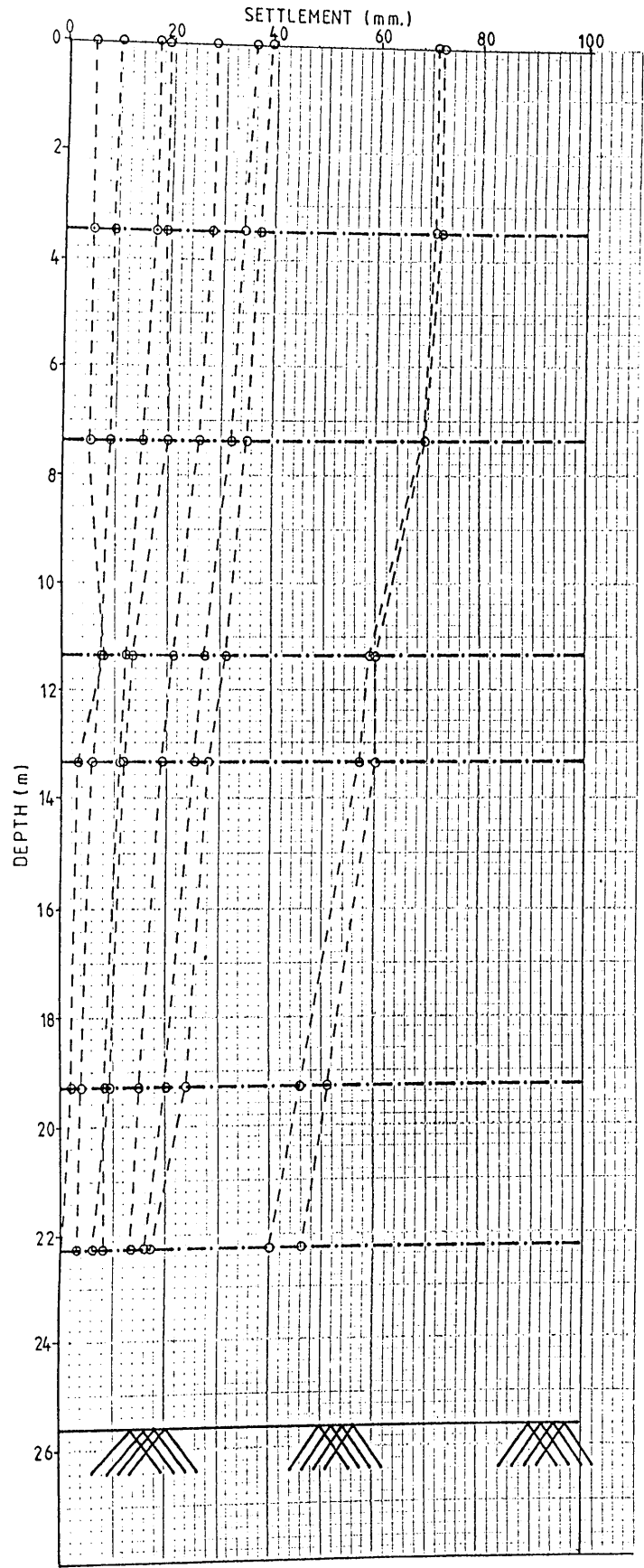

SETTLEMENT v DEPTH  
EXTENSOMETER E1.

FIGURE 5-3-68.

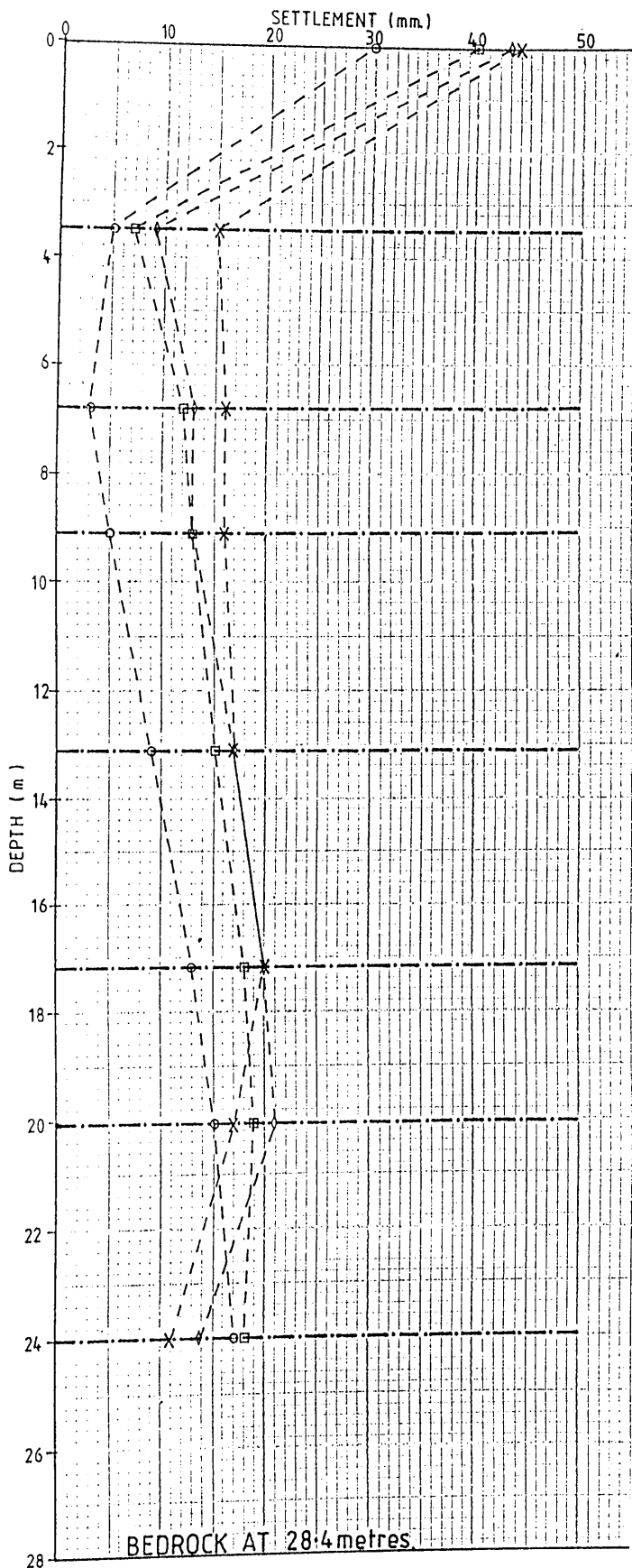

SETTLEMENT v DEPTH  
EXTENSOMETER E2.

FIGURE 5.3.69.



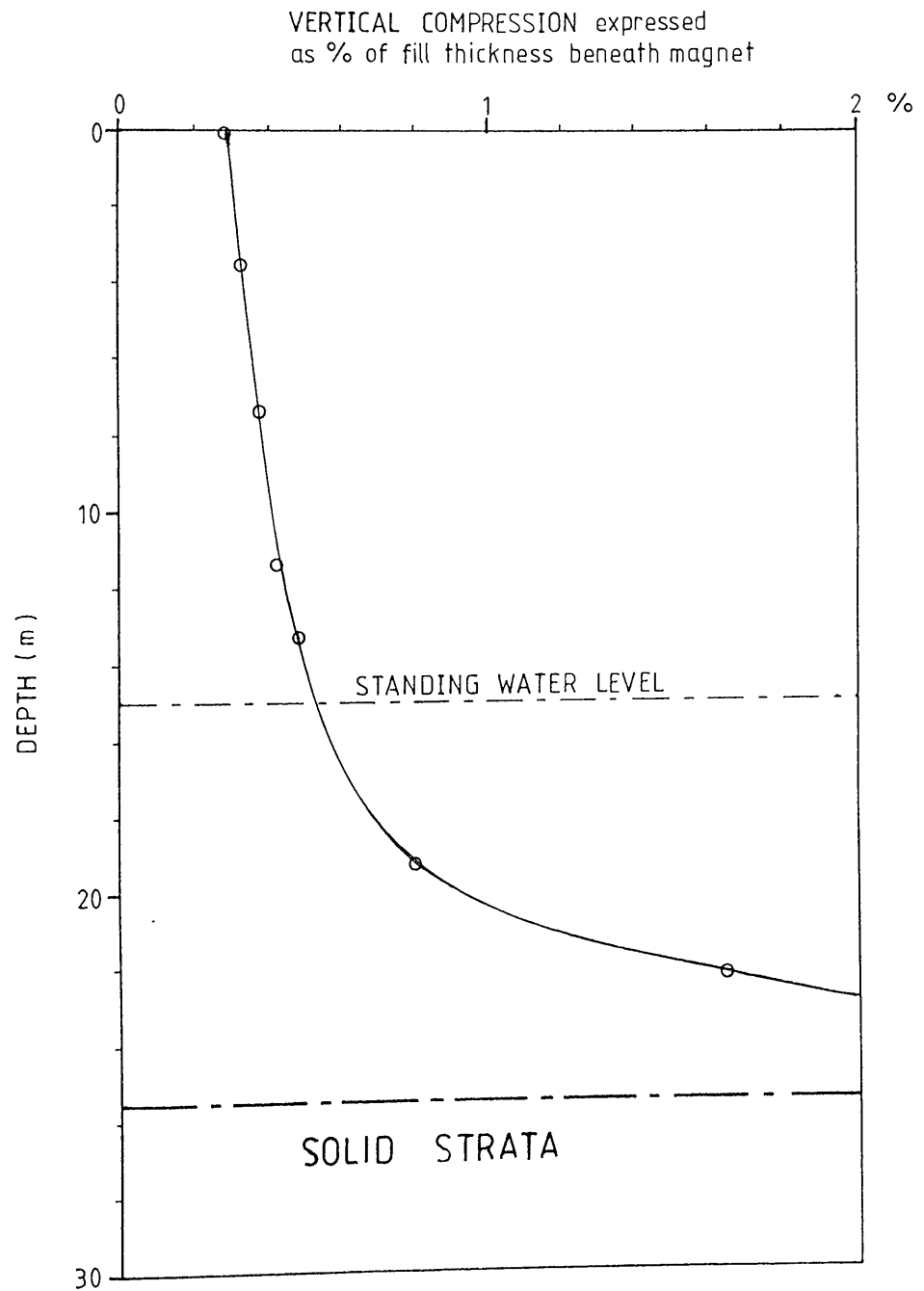

VERTICAL COMPRESSION - EXTENSOMETER E1.

FIGURE 5-3-70.

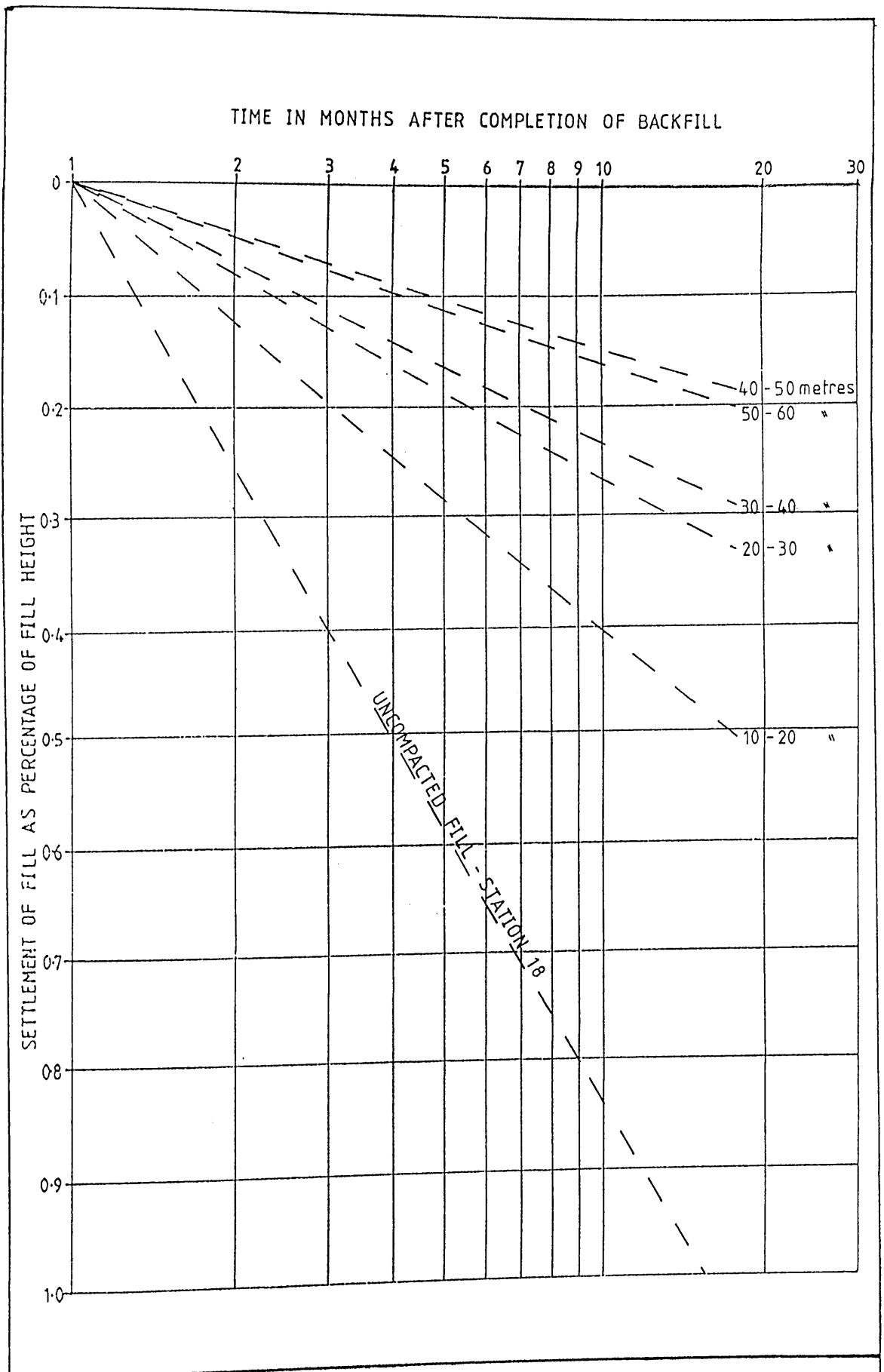

MEAN SETTLEMENT PLOTS (settlement zero at month 1)  
ESSINGTON.

FIGURE 5.3.71



PLATE 5-3-1 'Crown holes' close to south east corner of site.  
Oct, 1983.



PLATE 5-3-2 Adit entrance. Nov, 1983.



PLATE 5-3-3 Finished backfill area. March, 1986.



PLATE 5-3-4 Void space left at northern end of site. March, 1986.



PLATE 5-3-5 Ripping the formation. April, 1983.



PLATE 5-3-6 Excavation of Thick Coal pickings.

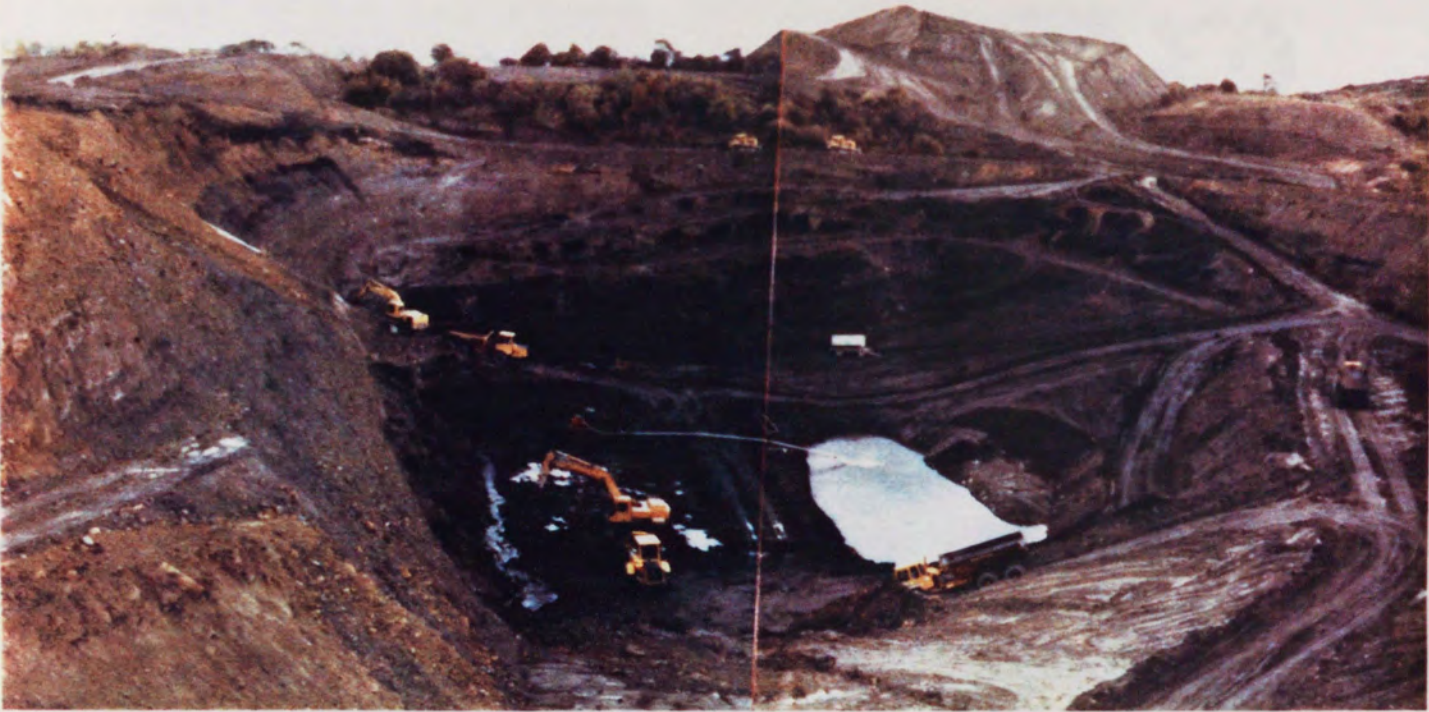

PLATE 5-3-7 Looking north over opencast area - excavation of Heathen coals in middle ground, Thick coal remnants exposed beyond. Oct, 1984.



PLATE 5-3-8 Looking east over final excavation area - Heathen coals and Thick coal pickings exposed.



PLATE 5-3-9 Open gallery in Thick coal - south end of western highwall Sept, 1983.



PLATE 5-3-10 Open gallery in Thick coal - north end of western highwall March, 1985.



PLATE 5-3-11 Looking north over opencast area backfill bench in foreground. July, 1984.



PLATE 5-3-12 Plate loading test. Aug. 1985.



## 5.4 MILKING BANK MEADOWS (PHASE IV), DUDLEY, WEST MIDLANDS

### 5.4.1 Introduction

Milking Bank Meadows is a restored opencast coal and fireclay mining site in Dibdale near Dudley, West Midlands (Figure 5.4.1). The site has been opencast mined and restored over a period of 12 to 20 years, the stages of these operations are complex. Phase IV is located within the main body of the site and has a relatively straightforward history, hence this phase has been chosen for analysis and comparison.

Following the completion of restoration of the site settlement survey stations were established and monitored at regular intervals. In addition conventional borehole investigations have been carried out. The results of this monitoring and testing are considered below.

### 5.4.2 Location and Description

The site is located approximately one mile west of Dudley, West Midlands, National Grid Reference SO 924 907.

This phase of the main site is bounded to the north by Phase III of this development area, to the east by proposed Public Open Space land, south by open land (proposed for housing) under a different ownership, and west by the New Grosvenor Road (Figure 5.4.2).

Prior to opencast mining the site was occupied by abandoned collieries and open grazing land, the ground was undulating with a general fall in level towards the south and south-east. Restoration, following the

opencast mining, has left the majority of the area (including this phase) with the same general levels although (until recently) the northern part of the site (parts of Phase II and III) was covered with fireclay mounds. The fireclay was won during opencasting together with coal but much of this clay has remained unused.

Within the past two years the fireclay mounds have been removed, the site levels adjusted, and (following investigations) housing development is proceeding in Phases I and II.

#### 5.4.3 Geology

Prior to opencast mining, the site was underlain by sporadic areas of fill (colliery discard) then rocks of the Middle (Productive) Coal Measures of the Carboniferous Period. The sequence is very similar to that at the Hurst Opencast site, consisting essentially of bedded and alternating mudstones, siltstones and sandstones, but with several important mineral seams of coal, fireclay and ironstone at various vertical intervals (Figure 5.4.3).

The strata in this area are folded and faulted by earth movements which post-date the deposition of the Carboniferous strata. Within this phase the strata dip to the east and south-east at an angle of between 6 and 10 degrees to the horizontal. The angle of dip tends to decrease eastward into a basin shaped depression (syncline).

The outcrop positions of a number of economically important mineral seams around the fringes of the site and the extent of the opencast area are shown on Figure 5.4.2. Two major north-west to south-east trending faults can be seen to disrupt the strata in this phase. The more northerly fault is the Dibdale fault, which is indicated to downthrow to the south, the magnitude of which is in the order of 12 to 15 metres. The Russells Hall fault passes along the southern boundary of this phase and is essentially the southern boundary of the opencast site; this fault also has its downthrow to the south, the magnitude of which is between 18 and 28 metres.

The Russells Hall fault is believed to have been a plane of weakness along which igneous rock (in a molten form) is believed to have forced its way upwards, in some instances, close to the surface. Intrusions of this igneous rock (dolerite) have been recorded in the south-eastern corner of the opencast site within the coal measures sequence, in some cases replacing coal seams, i.e. the seams have been 'burnt-out'.

#### 5.4.4 Past Mining History

Mining has been carried out from a number of former collieries on this site up until 1955 in seams from the Thick Coal down to the Bottom Coal (Figure 5.4.3). The extent of these workings was somewhat restricted due to the dolerite intrusions within the sequence.

Within this phase the majority of the seams were extracted by the 'total extraction' method whereby the

mineral was removed along a broad face or wall between roadways, no pillars being left as support to the roof.

#### 5.4.5 Opencast and Backfilling Operations

The major opencast mining operations in this site were undertaken between 1965 and 1974, primarily to extract the available coal and fireclay seams remaining following the earlier phases of underground mining referred to above. Within this phase the opencast excavation is believed to have extended to the Bottom Fireclay which is the deepest economically important mineral seam in the Middle Coal Measures of this area.

The opencast excavations followed the dip of the seams from the eastern boundary westward into the main site area. By March 1972 the workings were alongside the Old Grosvenor Road which is approximately the western boundary of this phase. Subsequently, opencasting was undertaken to the west, this was backfilled, the New Grosvenor Road constructed, and the area beneath the Old Grosvenor Road opencast in 1973. This phase (IV) is within the area of deepest excavation, the depth in the area of the Old Grosvenor Road being approximately 43 metres, decreasing eastwards to about 30 metres.

Restoration commenced in October 1973 and continued (in phases) up until August 1977. Within this phase, the deeper filling (below 30 metres) took place in November and December 1973, the material being placed by dump trucks and spread by D9 dozers. The remaining 30 metres or so was all placed in broad sweeps by self-propelled box scrapers in layers not exceeding 300mm in thickness.

These layers were compacted by the continual but varied passage of loaded scrapers having a total weight of up to 60 tonnes. The majority of this latter phase of restoration was carried out between August 1975 and November 1976, backfilling was generally stopped during the winter months.

During the above works, fill materials were taken from the large overburden mounds to the east (Phase I), mixed with some of the slurry from lagoons, and placed in the deeper excavations.

#### 5.4.6 Monitoring and Investigations

In April 1979, surface settlement stations were established across the majority of the accessible opencast area (Figure 5.4.4). These stations comprised 1.2 metre long, 19mm diameter, mild steel bars driven into the ground leaving 100mm protruding.

These stations were levelled at approximately six monthly intervals using a Zeiss 007 precise automatic level, siting onto an invar staff.

In 1983/84, site investigations were carried out in this phase and also Phase I, with the intention of establishing engineering parameters for the fill materials, the boundaries of the opencast area, the thickness of fill and to determine whether abandoned underground mineworkings were present beneath the opencast backfill.

Within this phase these investigations consisted of a series of cable percussive and rotary percussive boreholes. Testing/sampling was carried out at regular

intervals in the cable percussive boreholes, many of the samples subsequently being tested in the laboratory to determine index properties, dry density, grading analysis, shear strength, consolidation parameters and chemical properties. The rotary percussive boreholes were used as probes to determine the thickness of fill in some of the deeper areas and to determine the nature and type of bedrock.

It is of interest to compare the SPT N-values determined on this site with those from the Hurst Opencast site (Section 5.3.7.2). A composite of all of the SPT tests carried out at Milking Bank (Phases I to IV), plotted against depth, is shown in Figure 5.4.5.

It is evident that in this SPT v depth plot there is a wide scatter of results, thus reflecting the variable composition of the fill, i.e. from clay to rock dominant material. Considering the plot of mean N-values v depth an appreciable increase in N-value with depth is evident; close to the surface the mean N-value is about 26, thereafter increasing to about 55 at 20 metres depth.

Comparing the above with the very much more limited amount of SPT testing carried out at the Hurst site it would appear that:

- (a) The mean SPT N-values are similar close to the surface, but
- (b) the Milking Bank results indicate an increase in N-value with depth, whereas the Hurst results do not.

There is no reason to expect that the material at Milking

Bank was placed at a higher state of compaction than at the Hurst or is of a different composition. The only significant difference between the materials is that the Hurst backfill had been recently placed whereas the Milking Bank backfill had been placed about seven years before any SPT testing was carried out. It must therefore be concluded that the increase in N-value (density) with depth exhibited at Milking Bank is a function of time, i.e. long term consolidation of the fill.

#### 5.4.7 Settlement Observations

The results of settlement monitoring, continued up until 1983, are included in Figures 5.4.6 and 5.4.7 where it can be seen that the magnitude of settlement varies considerably between stations. Over the five and a half years of monitoring the total movement recorded has varied between 141mm of settlement to 15mm of heave, the mean total settlement being 37mm.

In order to analyse the results in any detail it is necessary to firstly discount those stations which have been disturbed by traffic or those located in areas which have had a complex or uncertain history during restoration. Although this can be done to a certain extent, it does reduce confidence in the analysis.

Plots of settlement against time for those stations which show the greatest settlement (and have not been disturbed) are shown in Figures 5.4.8 to 5.4.10 together with more typical settlement profile. Stations 95 and 96 represent the more typical settlement profiles and the

maximum settlements are represented by Stations 2, 3, 71, 78, 85, 87, 89 and 94.

From the settlement plots it would appear that, typically, the majority of settlement is completed within three to four years of restoration, the rate of settlement decreasing rapidly with time since restoration. For those stations showing maximum settlements, however, the rate of settlement is still appreciable after six years.

A linear relationship has been established when plotting several of these stations as logarithm of elapsed time against settlement, expressed as a percentage of fill height (Figure 5.4.11). In the six years since restoration settlement has typically been 0.2 to 0.25 percent of fill height; at isolated stations, however the settlement has been between 0.45 and 0.75 percent. It is likely that settlement will continue for between 9 and up to 12 years (Kilkenny, 1968) and therefore settlement could represent between 0.2 to 0.3 percent (typical result) and up to nearly 0.9 percent (maximum).

#### 5.4.8 Summary

Although the fill thickness in this phase of the opencast site is not great (30-43 metres), the time taken to complete the backfilling has been drawn out due to stoppages in the winter months. The time taken to complete the backfilling was between two and three years.

At depths in excess of 30 metres (relative to finished ground level) the compactive effort has been negligible,



above this there has been a reasonable degree of compactive effort applied (by earthmoving plant) but the control on this operation was not high.

SPT tests carried out on the entire Milking Bank site indicate that there is an increase in density with depth, unlike the Hurst site where the density is relatively uniform throughout. This increase in density is believed to be as a result of long term consolidation of the fill, a process which is incomplete at the Hurst site.

Settlement is likely to continue beyond the date for which data is available, i.e. approximately six years after completion of restoration. Although the settlement results vary greatly, the magnitude of settlement at a 'typical' station (0.2 to 0.3 percent) is similar to that determined at controlled backfill sites, but in this case the settlement has taken place over a much longer time period. The magnitude of settlement at isolated stations (0.5 to 0.9 percent) more clearly matches values and timing derived at uncompacted sites, such as Chibburn (Kilkenny, 1968).



**Aston University**

**Content has been removed for copyright reasons**

SITE LOCATION PLAN - MILKING BANK MEADOWS.

Scale 1:50 000

FIGURE 5.4.1.

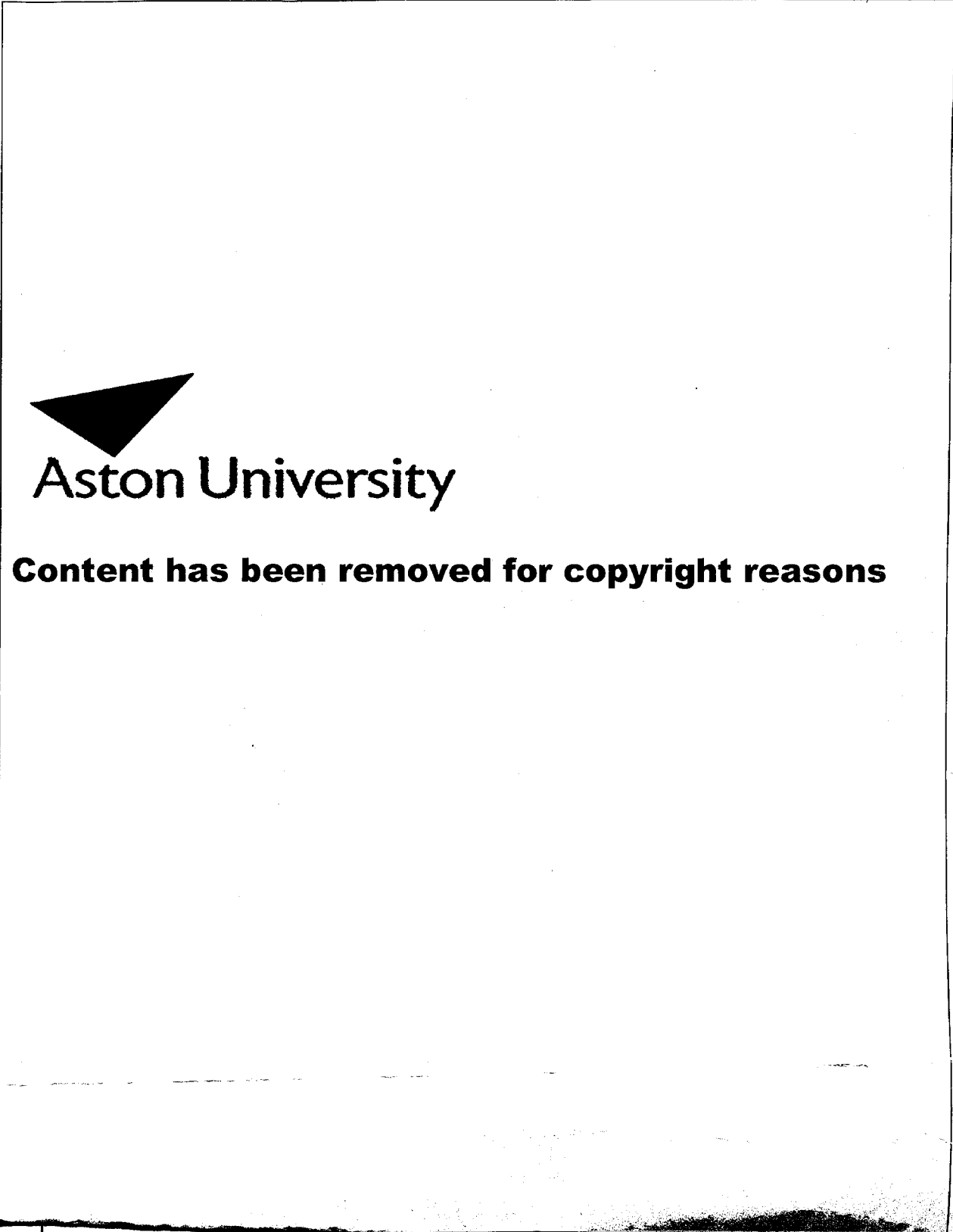

GENERAL GEOLOGY AND LOCATION OF PHASE IV  
MILKING BANK MEADOWS. Scale 1:10 000  
FIGURE 5.4.2.

<u>Seam</u>	<u>Unworked Thickness</u> <u>(m) Approx.</u>	<u>Vertical Interval</u> <u>(m) Approx.</u>
THICK COAL (burnt)	10.0	
Mudstone and Ironstone		6.10
HEATHEN COAL	1.5	
Seatearth, mudstone, sandstone and Pennystone ironstone		10.60
STINKING COAL (in three leaves)	1.0-1.5	
Mudstone, sandstone ironstone and seatearth		7.70
NEW MINE COAL	0.4-0.6	
Seatearth		1.80
FIRECLAY COAL	0.5-0.6	
TOP FIRECLAY	1.7	
Mudstone and sandstone		5.40
COAL	0.6	
FIRECLAY	0.3	
Sandstone		3.10
COAL	0.6	
Mudstone, shale		1.60
FIRECLAY	0.6	
Coal and shale		0.15
BOTTOM FIRECLAY	1.4	
Mudstones, sandstones and fireclay		

GENERALISED STRATIGRAPHICAL SUCCESSION  
MILKING BANK MEADOWS.

FIGURE 5.4.3.

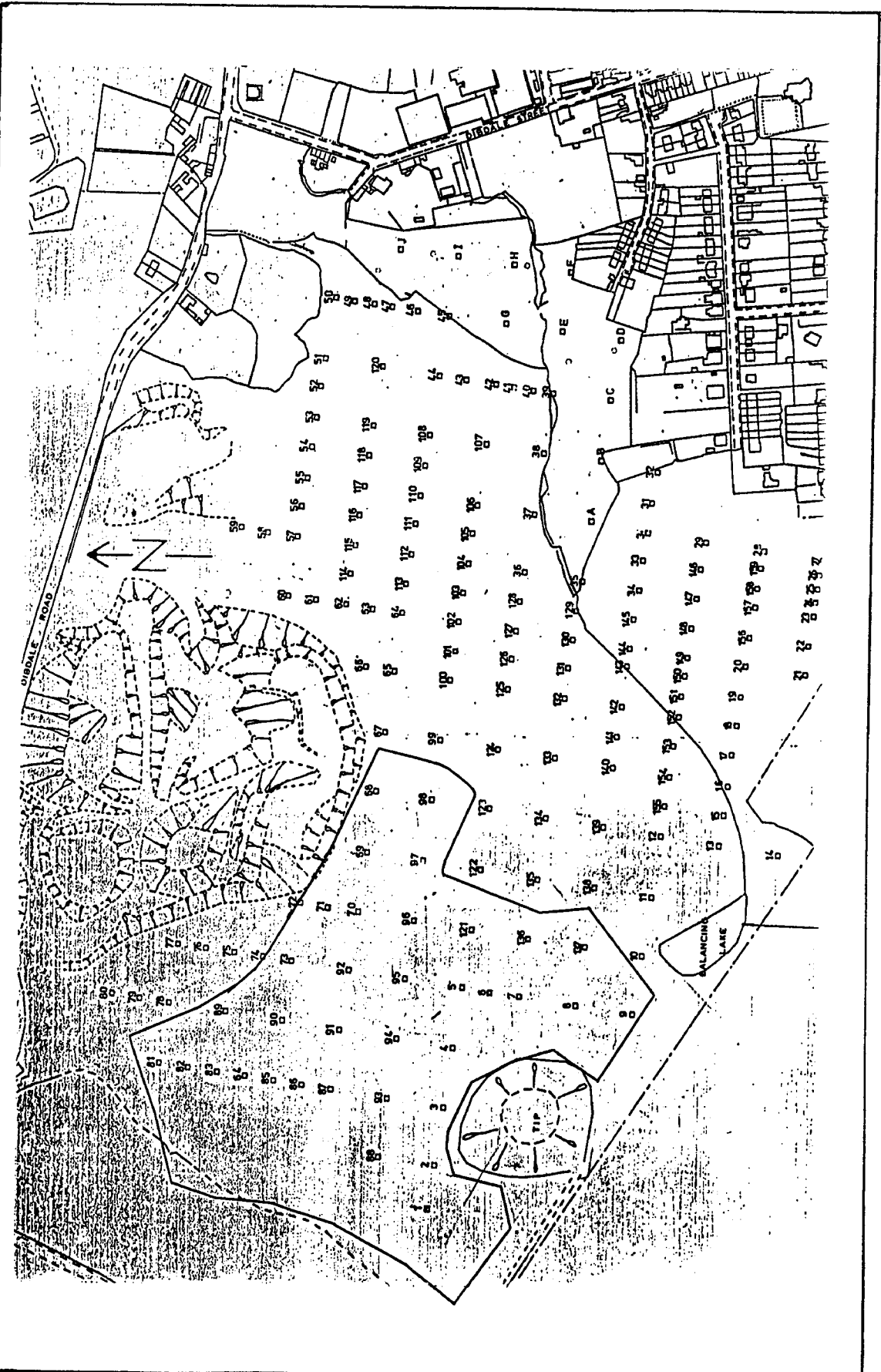

LOCATION OF SURFACE SETTLEMENT STATIONS • MILKING BANK MEADOWS. (Not to scale).

FIGURE 5-4-4.

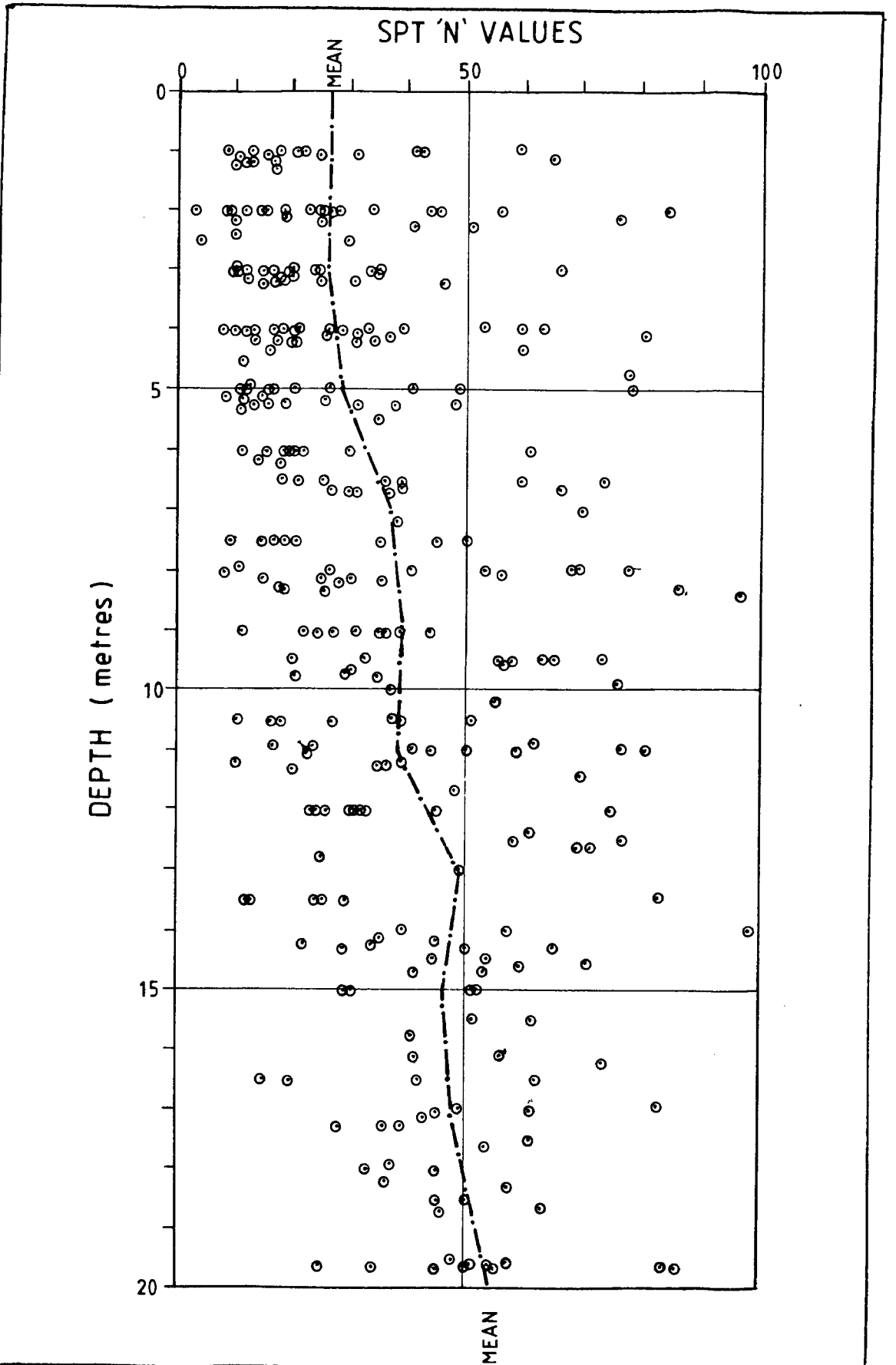

PLOT OF SPT N VALUE AGAINST DEPTH-MILKING BANK.

FIGURE 5-4-5.

STN NO.	24.5.78	19.5.80	9.12.80	17.8.81	15.10.82	12.10.83	Latest Movement	Total Movement.
1	147.170	147.156	147.152	(147.131	147.123	147.116	- 7mm	- 36
2	146.410	146.348	146.341	146.332	146.322	146.317	- 5	- 93
3	144.866	144.783	144.773	(144.754	144.734	144.719	-15	-141 (estimated)
4	143.960	143.931	143.927	143.921	143.912	143.905	- 7	- 55
5	143.984	143.969	143.966	143.960	143.947	143.944	- 3	- 40
6	142.201	142.187	142.185	142.181	142.173	142.171	- 2	- 30
7	140.740	(140.592	140.575					
8	138.540	138.534	138.530	138.526	138.516	138.510	- 6	- 30
9	136.745	136.761	136.762	136.762	136.758	136.760	+ 2	+ 15
10	137.023	137.013	137.014	137.010	137.013	137.007	- 6	- 16
67	156.502	(156.291	156.281	156.278	156.284	156.282	- 2	- 34
68	154.714	154.733	154.728	154.726	154.729	154.727	- 2	+ 13
69	152.987	152.989	152.982	152.976	152.976	152.972	- 4	- 15
70	151.779	151.788	151.782	151.780	151.781	(151.734		
71	153.617	153.558	153.544	153.534	153.531	153.526	+ 5	- 91
72	155.650	155.621	155.612	155.602	155.598	155.591	- 7	- 59
73	154.795	154.805	154.802	154.800	154.803	154.803	0	+ 8
74	156.469	156.476	156.471	156.465	156.459	156.456	- 3	- 13
75	158.467	158.471	158.467	158.463	158.463	158.462	- 1	- 5
78	161.158	161.127	161.117	161.098	161.084	161.076	- 8	- 82
81	159.713	159.725	159.723	159.719	159.719	159.719	0	+ 6
82	157.810	157.819	157.815	157.811	(157.685	157.683	- 2	- 1
83	155.886	155.892	155.889	155.885	155.885	155.885	0	- 1
84	154.054	154.047	154.040	154.034	154.028	154.023	- 5	- 31
85	152.252	152.227	152.219	152.214	152.177	152.171	- 6	- 81
86	150.456	150.417	150.408	150.398	150.388	150.382	- 6	- 74
87	149.181	149.138	149.127	149.117	149.106	149.096	-10	- 85
89	156.733	156.707	156.697	156.680	156.670	156.662	- 8	- 71
90	153.462	153.446	153.438	153.433	153.428	153.422	- 6	- 40
91	149.940	149.915	149.907	149.901	149.895	149.892	- 4	- 49
92	150.738	150.704	150.697	150.693	150.690	(150.623		

SUMMARY OF SETTLEMENT RESULTS - PHASE IV  
MILKING BANK MEADOWS.

FIGURE 5.4.6.

STN NO.	24.5.78	19.5.80	9.12.80	17.8.81	15.10.82	12.10.83	Latest Movement	Total Movement.
93	147.689	147.645	147.638	147.629	147.620	147.615	- 5	- 52
94	147.467	147.401	147.389	147.375	147.361	147.353	- 8	-114
95	147.077	147.059	147.053	147.050	147.044	147.040	- 4	- 37
96	147.974	147.954	147.947	147.943	147.939	Disturbed		
97	148.899	148.913	148.909	148.909	148.912	148.913	+ 1	- 34
98	150.376	150.395	150.360	150.360	150.364	150.364	0	+ 13
99	151.509	151.528	151.525	151.524	151.515	151.514	- 1	- 13
121	144.882	144.870	144.865	144.858	144.849	144.838	-11	- 44
122	145.808	145.822	145.814	145.808	145.788	145.769	-19	- 39
126	152.688	152.697	152.677	152.675	152.675	152.669	- 6	- 19
137	139.024	139.001	138.998		(138.819			
138	140.338	140.343	140.342	140.339	140.335	140.333	- 2	- 5

Note:

(= station disturbed)

SUMMARY OF SETTLEMENT RESULTS - PHASE IV,  
MILKING BANK MEADOWS.

FIGURE 5.4.7.



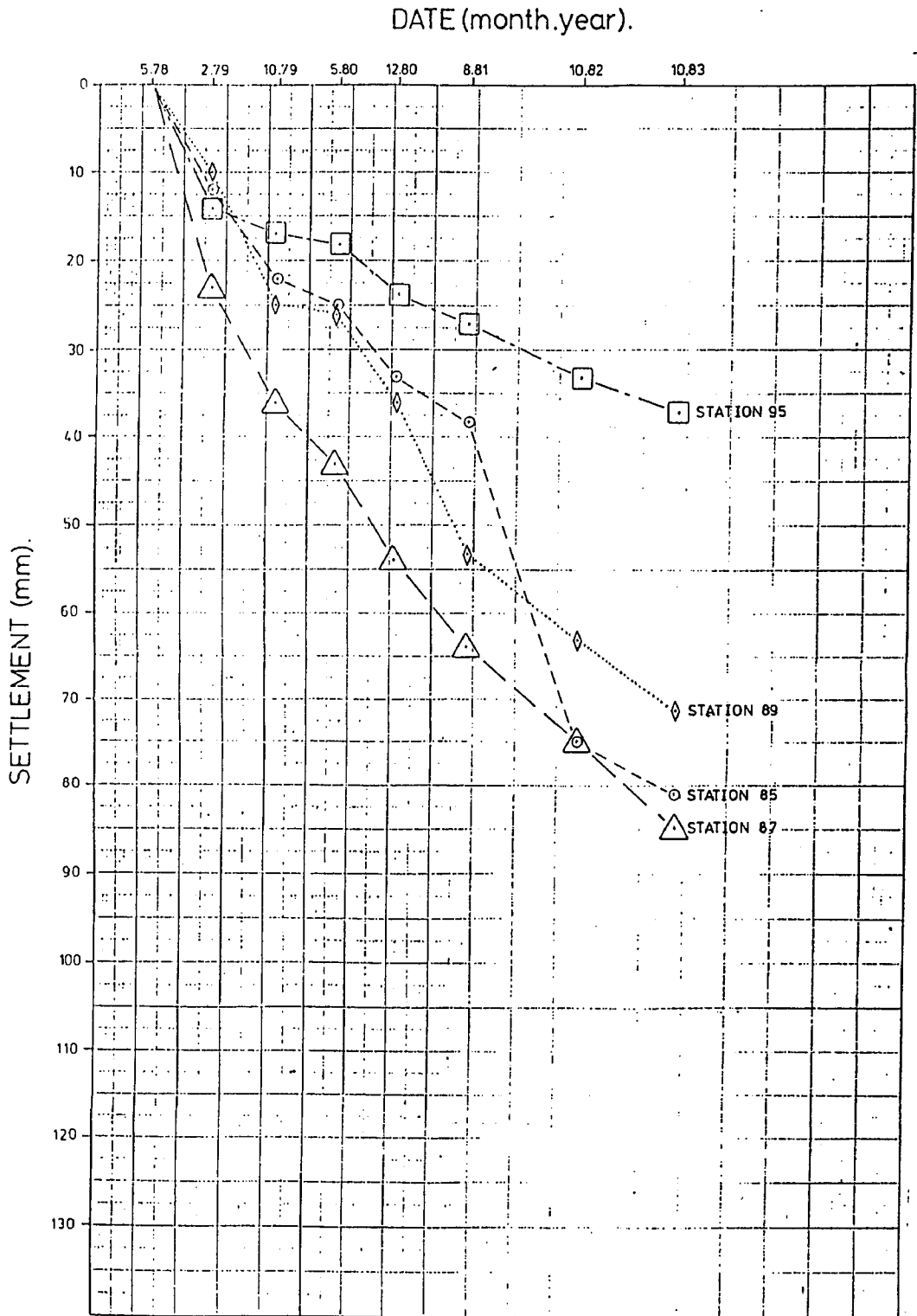

SETTLEMENT v TIME  
PHASE IV, MILKING BANK MEADOWS.

FIGURE 5.4.8.

DATE (month.year).

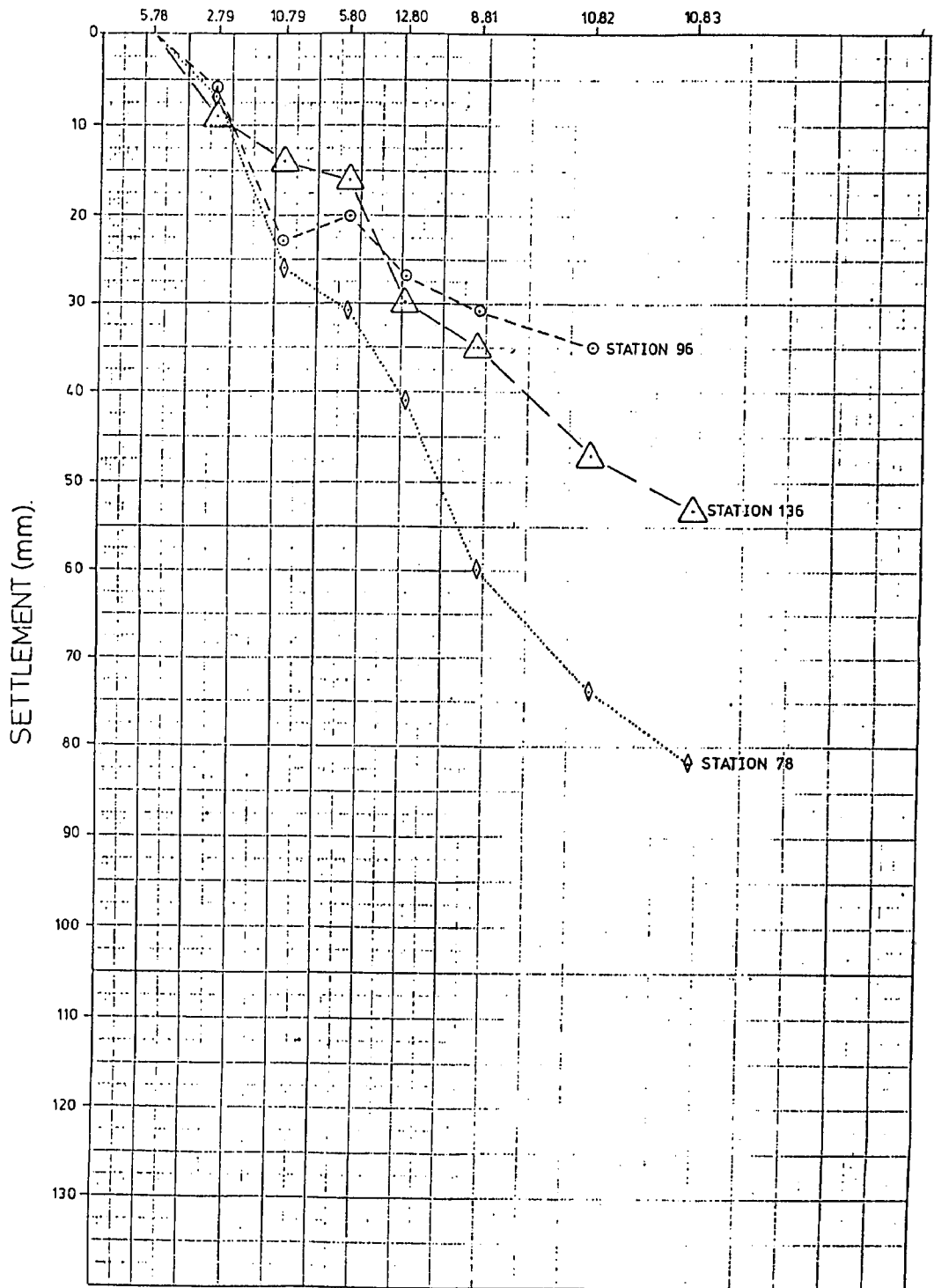

SETTLEMENT v TIME  
PHASE IV, MILKING BANK MEADOWS.

FIGURE 5-4-9

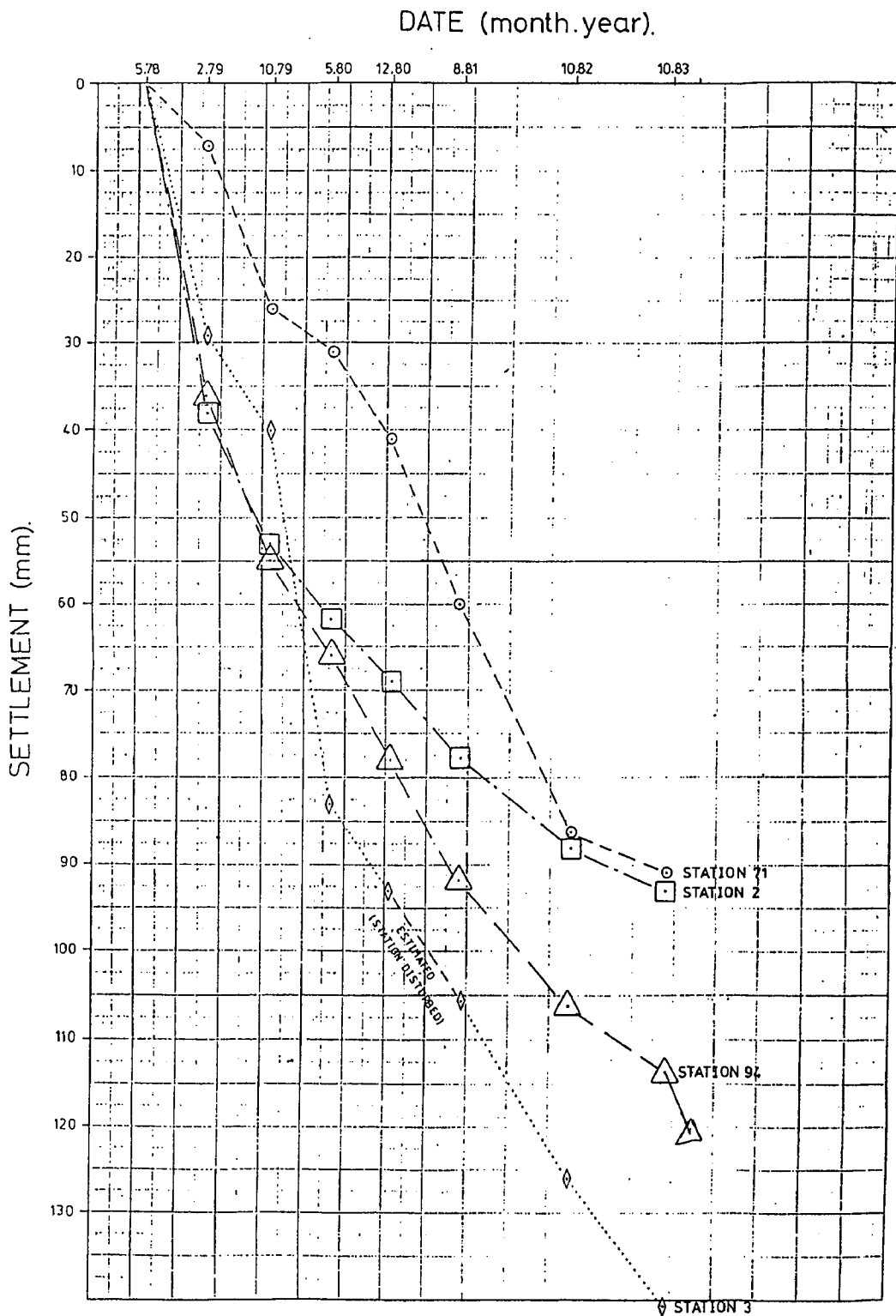

SETTLEMENT v TIME  
PHASE IV, MILKING BANK MEADOWS.

FIGURE 5.4.10.

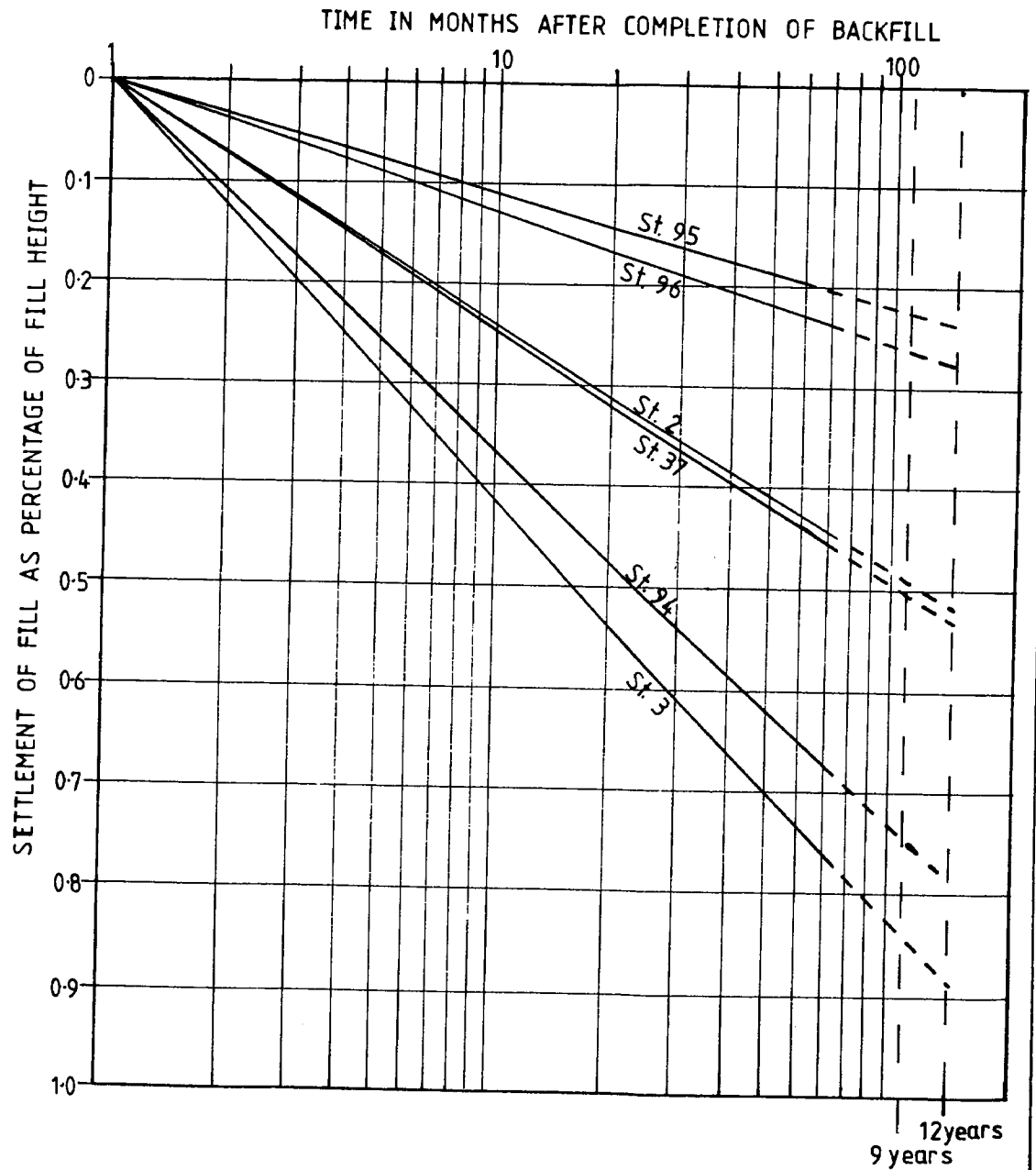

SETTLEMENT (expressed as percentage of fill height)  
 AGAINST LOGARIT OF TIME. PHASE IV, MILKING  
 BANK MEADOWS.

FIGURE 5-4-11.

## 6. COMPUTER MODELLING

- 6.1 Introduction to Modelling Techniques.
- 6.2 Finite Element Program.
- 6.3 Basic Model.
- 6.4 Application to Site Sections and Depth Profiles.

## 6.1 INTRODUCTION TO MODELLING TECHNIQUES

Use has been made of a simple two dimensional linear elastic finite element analysis to consider the pattern of settlement which develops in the vicinity of highwalls to backfilled opencast sites. This has been carried out in order to determine whether the use of such techniques can provide accurate predictions of backfill settlement in these areas. The results are compared with detailed predictions made (based on settlement observations) in the case study sites referred to previously.

The basis of the finite element method is the representation of a body or a structure by an assemblage of sub-divisions called 'finite elements'. These elements are considered interconnected at joints which are called 'nodes' or 'nodal points'. Simple functions are chosen to approximate the distribution or variation of the actual displacements within each finite element, these are referred to as displacement functions. The unknown magnitudes of the displacement functions are the displacements at the nodal points. Hence, the final solution will yield the displacements at discreet locations in the model, the nodal points (Desai and Abel, 1972).

There is no restriction, other than the number of elements, on the complexity of geometry which can be handled by this form of model. Self weight can be incorporated by applying the appropriate forces at each node and stiffness properties of each element can be evaluated individually, hence it is possible to deal with nonhomogeneity and anisotropy as well as homogeneity and isotropy.

Since soil behaviour is usually non-linear, simple linear elastic theory can only be applied to relatively straightforward cases. Although methods exist for dealing with complex non-linear stress-strain relationships, unless the relevant soil parameters and geometry are known in considerable detail, the simple elastic methods can yield results of sufficient accuracy for practical purposes.

## 6.2 FINITE ELEMENT PROGRAM

The finite element computer program used in the following analysis was developed by Dr. D. Just (Dept. of Civil Engineering, Aston University). This program is written in the FORTRAN computer language for use on an ICL 1904S computer. A sub-routine has been added to this program to enable the model section and displacement results to be plotted. This sub-routine incorporates 1900 GINO graph plotter routines (Aston University, 1980).

A listing of the computer program is presented in Appendix II, the sub-routines used in the program are outlined below:

### Sub-routines

STANDARDISE

JOINT GROUP - reads joint numbers and positions, then sets up the co-ordinates into arrays.

JN = Joint Number

XC = X-coordinates

YC = Y-coordinates

D = Degrees of Freedom

LJ = Lowest Joint Number

RECTANGULAR SHELL GROUP - reads element numbers and joint  
belonging to each element.

RP = Element Number  
 RJØ = First (lowest) Joint Number belonging to Element  
 RJT = Second " " " " "  
 RJTH = Third " " " " "  
 RJF = Fourth " " " " "

RECTCDC - reads element parameters and layer thickness for each  
element.

E = Young's Modulus  
 RDC (2) = Poisson's Ratio  
 RDC (19) = Layer Thickness

RFDC - calculates X and Y lengths for each element.

RF AREA 1,2 )  
 SHELL RECTSUB )  
 R SHELL TRISUB )  
 RECTWRITE ) Define stiffness contribution of each  
 TRI AREA 1,2,3,4 ) element, the element properties and  
 RECT AREA 1,2,3,4,5,6) locations of stiffness matrix in array W.  
 KWRITE )  
 RS STRAIN )  
 READ LOAD VECTOR )

PRINT DEFLECTION VECTOR -

K = Joint Number (1 to NOJ)  
 HB (II) = X and Y deflections  
 (i.e. HB (I) = X-coordinate  
 HB(II) = Y-coordinate)



DISCOM DIV - main solution routine  
 GRAPH - defines X and Y axes, prints model array,  
 deflections at each joint and draws the titles.

The input parameters required in each run are as follows:

### Reference

I 1 - maximum number of joints in two groups and those  
 connected.  
 I 3 - total number of degrees of freedom in the structure +1  
 (i.e. 1's + 1).  
 I 5 - total number of locations for stiffness matrix (up to  
 9000).  
 I 6 - maximum number of joints in a group and those connected.  
 I 7 - maximum number of elements crossing a group boundary.  
 I 8 - 19 x (maximum number of elements crossing a group + 1).  
 NTØT - number of blocks required for immersion + 1.  
 \*NL - number of load cases  
 \*LAZ - total number of suppressed degrees of freedom (0's).  
 \*NØG - total number of groups.  
 \*NØJ - total number of joints.  
 \*NRP - number of elements.

\* need to be precise.

Also for each element:

E - Young's Modulus (MN/m<sup>2</sup>)  
 RDC (2) - Poisson's Ratio  
 RDC (19) - Layer Thickness (metres)  
 NL - Loads (KN)

### 6.3 BASIC MODEL

A basic theoretical model was used to examine the influence of the inclination of a buried highwall on the differential settlement which may occur at the surface. In addition, the influence of changing stiffness parameters on the displacements was examined.

In each case, restraint was applied in the X - direction along the side boundaries of the model and in both X and Y directions along the base boundary (Figure 6.3.1), all other nodes remained free to move in both directions.

Values adopted and assumptions made were based on those used in the analysis of Scammondon Dam which is a large embankment dam (Penman et al, 1973). The analysis is complicated by the fact that the fill is added in successive layers, each layer not only applying load to the underlying material due to its self-weight but also adding stiffness to the structure as a whole.

At Scammondon Dam large oedometer tests were used as a basis for obtaining the 'elastic' properties of the rockfill. Poisson's ratio  $\nu'$  was determined from the following expression:

$$\nu' = \frac{1 - \sin \phi'}{2 - \sin \phi'} \quad \text{----- 1}$$

Large diameter triaxial tests were used by Penman et al. to determine  $\phi'$ . Taking values of  $\phi'$  of between 40 to 44 degrees, a mean  $\nu'$  value of 0.25 was selected.

It can be shown that for a condition of confined compression 'Young's modulus'  $E'$  is related to the coefficient of volumetric compressibility  $m_v$  by the following expression:

$$E' = (1 + \nu')(1 - 2\nu')/(1 - \nu') m_v \quad \text{----- 2}$$

for  $\nu' = 0.25$  this expression becomes:

$$E' = 5/6 m_v \text{ ----- } 3$$

Using the results obtained from the oedometer tests coefficients of volumetric compressibility were calculated for each slice height (appropriate effective stress level) and were converted to corresponding 'Young's modulus' values using equation 3; these are plotted against depth of fill in Figure 6.3.2.

In the following examples, the 'Young's modulus' value adopted for each layer corresponds to the depth of fill above that layer, measured to its mid-point.

For each model the settlement recorded is that which occurs immediately following the placement of the final layer of fill. No account can be made in a single model for the settlement which occurs from the placement of deeper fill layers. However, an appreciation of the settlement due to deeper layers may be estimated from a build-up model, where models are produced depicting the progressive build-up of the fill in layers, and the resulting settlement is calculated by superposition.

From either approach it is not possible to directly compare the magnitude of settlement predicted by the Finite Element model with that from settlement observations, since settlement monitoring is not begun until backfilling is complete. The latter is a composite of the settlement which occurs through consolidation of all of the fill, the proportion of settlement which occurs at each layer being primarily a function of burial depth and time. No time element is incorporated in the Finite Element model, all settlement is considered instantaneous.

It may, however, not be unreasonable to use the model to predict the 'pattern' of surface settlements. Stiffness

properties can be modified in the model to produce settlement values which match those determined by monitoring.

### 6.3.1 Models C1 to C4

Models C1 to C4 consider a highwall face inclined between 90 degrees (C1) and 45 degrees (C4) to the horizontal. The basic parameters, based upon the above, are as follows:

Total Fill thickness - in opencast area	: 28 metres
- outside opencast area	: 4 metres
Individual Layer thickness	: 4 metres
Backfill - Young's Modulus	: 4 to 21.3 MN/m <sup>2</sup>
- Poisson's Ratio	: 0.25
- Bulk Density	: 2.16 Mg/m <sup>3</sup>
Solid Strata - Young's Modulus	: 120 MN/m <sup>2</sup>
- Poisson's Ratio	: 0.15

The model sections and displacements produced by the program are shown in Figures 6.3.3 to 6.3.6. Plots of tensile and compressive strains between the surface nodes are included for each case. The values of 'Young's modulus' used for individual backfill layer are included in Figure 6.3.3.

The magnitude of settlement recorded at the surface in the main body of the backfill represents about 0.14 percent of the fill height. This settlement is that indicated to occur following the placement of the last layer of backfill. As detailed above, the settlement

resulting from the placement of the deeper fill layers cannot be accounted for in a simple model of this kind, of more value is the pattern of movements in the backfill.

Adopting a limiting differential settlement of 0.1 percent in these models, the width of the 'sterilised' areas resulting from these varying highwall angles is considered. A brief summary is as follows:

Zone of Unacceptable Differential Settlement

<u>Model</u>	<u>Width Inside</u> <u>Excavating Area</u> (m)	<u>Width Outside</u> <u>Excavation</u> (m)	<u>Maximum Differential</u> <u>Settlement</u> (%)
C1	8	2	0.17
C2	8	2	0.17
C3	8	2	0.14
C4	Between 2 and 8 metres from high- wall edge.	-	0.12

From the above, it would appear that for the parameters adopted, the width of the sterilised zone would remain essentially the same for each inclination of the highwall. There is, however, a trend of decreasing differential settlement with inclination. Had angles less than 45 degrees been considered, the magnitude of differential settlement is likely to be less than 0.1 percent, i.e. no sterilisation zone would be necessary.

The above trends were confirmed at the Hurst site (Section 5.3.7.3). Over steep highwalls the sterilised zone was narrow but the magnitude of differential settlement was high. Where the highwall was more gently inclined, however, the sterilised zone was wide but the magnitude of differential was

comparatively low.

From the information provided in the analyses, plots of compressive and tensile strains have been produced at the surface of the fill. As would be expected, the magnitude of both compressive and tensile strains decreases with decreasing differential settlement. In each case the point of maximum tension is centred over the uppermost edge of the highwall and maximum compression within the backfill area. The point of maximum compression tends to move away from the highwall with a decrease in highwall inclination - see the following table:

<u>Model</u>	<u>Distance From Top of Highwall of Maximum Compression (m)</u>	<u>Inclination (Degrees)</u>
C1	6.5	90
C2	14.0	72
C3	18.0	56
C4	27.5	45

The above pattern has been demonstrated at the Holly Bank site in Section E3 where the maximum compression was centred over the area of greatest settlement with tension recorded on the flanks of the backfilled area (Section 5.2.8.6).

### 6.3.2 Models C12 to C15

Models C12 to C15 are essentially the same model as C1 but the stiffness of the elements has been varied to investigate their influence on the magnitude of surface settlement. The 'Young's modulus' values adopted in

these models are included with the model sections in Figures 6.3.7 to 6.3.10.

Maximum surface settlement recorded in these models varied appreciably, i.e.

<u>Model</u>	<u>Maximum Settlement (as percentage of Fill Height)</u>	<u><math>\nu'</math></u>	<u>Average <math>E'</math> (MN/m<sup>2</sup>)</u>
C1	0.14	0.25	15.0
C12	0.17	0.25	12.0
C13	0.33	0.25	8.0
C14	0.17	0.25	14.3
C15	0.19	0.20	12.0

It is clear from the above that with decreasing values of stiffness, the magnitude of settlement increases. This will, in turn, result in a wider sterilised zone and greater differential settlement. As an example, based on the limiting differential settlement of 0.1 percent, the width of the sterilised zone from the edge of the highwall in model C13 increases to 12 metres from 8 metres in model C1.

#### 6.4 APPLICATION TO SITE SECTIONS AND DEPTH PROFILES

It would appear from the above that although there are difficulties in comparing the magnitude of settlement in the models with the case study results, a very similar settlement pattern can be observed. In order to examine this further, finite element models have been produced which have similar profiles to sections at Holly Bank and the Hurst.

#### 6.4.1 Holly Bank Sections

Three finite element models have been produced to resemble the highwall (or burial highwall) profiles along which settlement measurements have been made at the Holly Bank Opencast site referred to in Section 5.2.

Included with each section (Figures 6.4.1 to 6.4.3) are surface settlement profiles produced from the finite element model and as predicted by settlement monitoring.

Section E1 (Figure 6.4.1) - the surface settlement plots would appear to be similar, both indicate very little differential settlement across the buried highwall. The magnitude of settlement produced by the finite element model is about half the predicted amount. Hence what variation there is in differential settlement, is also correspondingly less.

Section E3 (Figure 6.4.2) - there is a major difference in the surface settlement plots, principally across that portion of the section underlain by uncompacted fill. The predicted settlement plot indicates far higher settlements across this section than the finite element model. Although the 'Young's modulus' values were reduced for the uncompacted backfill (as compared to the compacted fill) they would appear to be far too high (i.e. too stiff) for a comparison to be made.

Section E7 (Figure 6.4.3) - there is a close relationship between the surface settlement profiles in this model, especially considering the difference in the spacing of monitoring/node positions



The above sections tend to confirm the results of the basic model, in that the 'pattern' of settlement produced by the finite element models closely match that produced on site providing sensible stiffness properties are adopted. Hence, it would appear that a simple two-dimensional linear elastic finite element analysis can produce similar settlement profiles to that produced on site. The magnitude of settlements is, however, not necessarily representative of that which will occur.

#### 6.4.2 Hurst Section

Section H1 at the Hurst opencast site has also been reproduced in a finite element model and the surface settlement plot (H1) compared against the plot predicted from settlement monitoring (Figure 6.4.4). Here again the plots are similar.

Settlement information is available at various depths in the backfill from the magnet extensometer installation E1, the location of which is included on this section. Analysis has therefore been undertaken to determine what E values would need to be adopted in the finite element model to produce a similar settlement profile to extensometer E1.

A further 16 runs of this model were carried out (H11 to H26) adopting a wide range of 'Young's modulus' values. The settlement profile at the position equivalent to extensometer E1 are presented in Figures 6.4.5 to 6.4.8, each of which includes the recorded settlement profile for E1, the values of 'Young's moduli' adopted in these runs are detailed in Figure 6.4.9.

The results indicate that the normal relationship of increasing stiffness with depth (Figure 6.3.2) tends to produce a similar settlement profile to E1 at shallow depths, but below 10-12 metres they diverge (e.g. H11). Reasonable correlation is not achieved until the backfill is considered to be much stiffer at the surface and far less so at depth (e.g. H26).

It would be inappropriate to consider that the stiffness of the backfill will decrease with depth. Since self weight for each layer increases with depth, the stiffness of the backfill will also increase with depth.

Saturation of the lower portion of the backfill may, however, cause additional consolidation. Had none of the backfill become saturated then the settlement profile at E1 may have matched a model such as H11.

For comparison with the above, 'build-up' models of H1 have been produced (H100 to H108) which consider the settlement resulting from the progressive placement of each backfill layer (Figures 6.4.10 to 6.4.18). Young's modulus values adopted being those derived from Figure 6.3.2.

Considering the settlement at E1, a plot of settlement can be produced by superposition (Figure 6.4.19). This clearly shows that the magnitude of settlement calculated to occur within the fill at depth is much greater than can be considered in a single model analysis. The actual settlement which will occur within the fill following the

placement of the last backfill layer will be a percentage of this cumulative settlement plot, the percentage decreasing with depth.

TABLE 10. SETTLEMENT OF BASIC PILE (CENTRAL) PILES

FIGURE 10

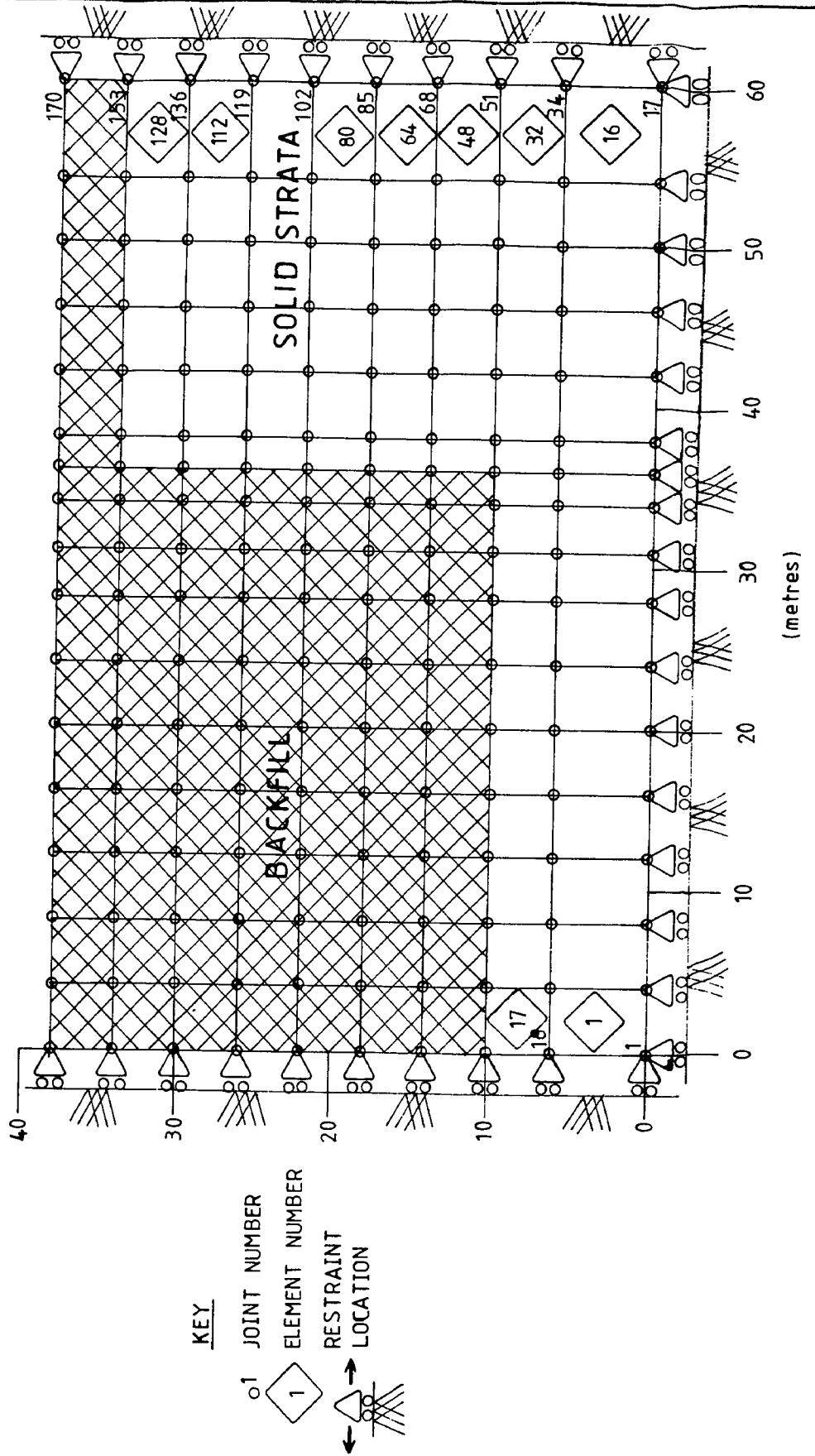

GENERAL OUTLINE OF BASIC FINITE ELEMENT MODEL.

FIGURE 6·3·1

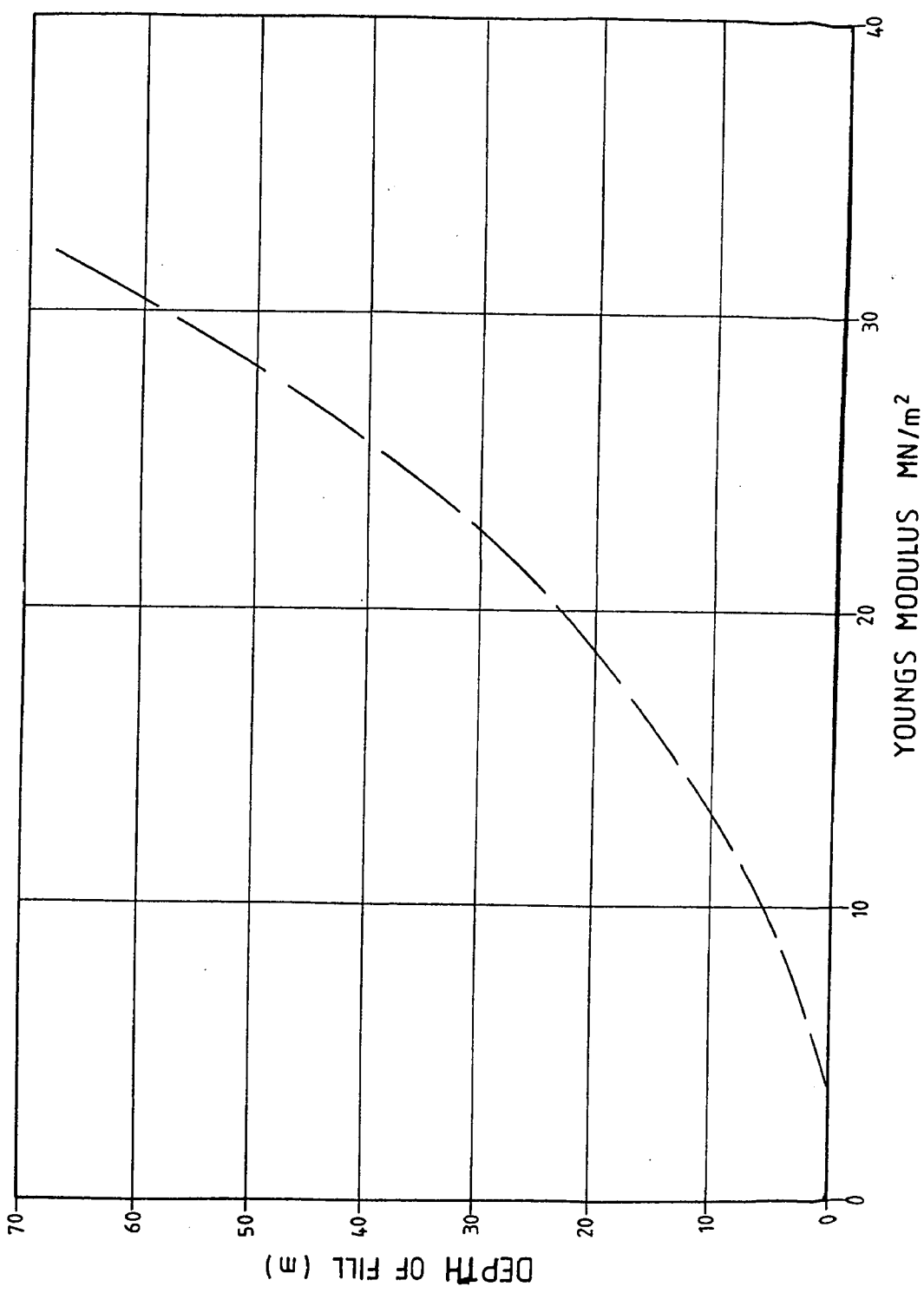

YOUNGS MODULUS v DEPTH OF FILL.

FIGURE 6.3.2.

PLOT OF DISPLACEMENTS DUE TO SETTLEMENT OF FILL

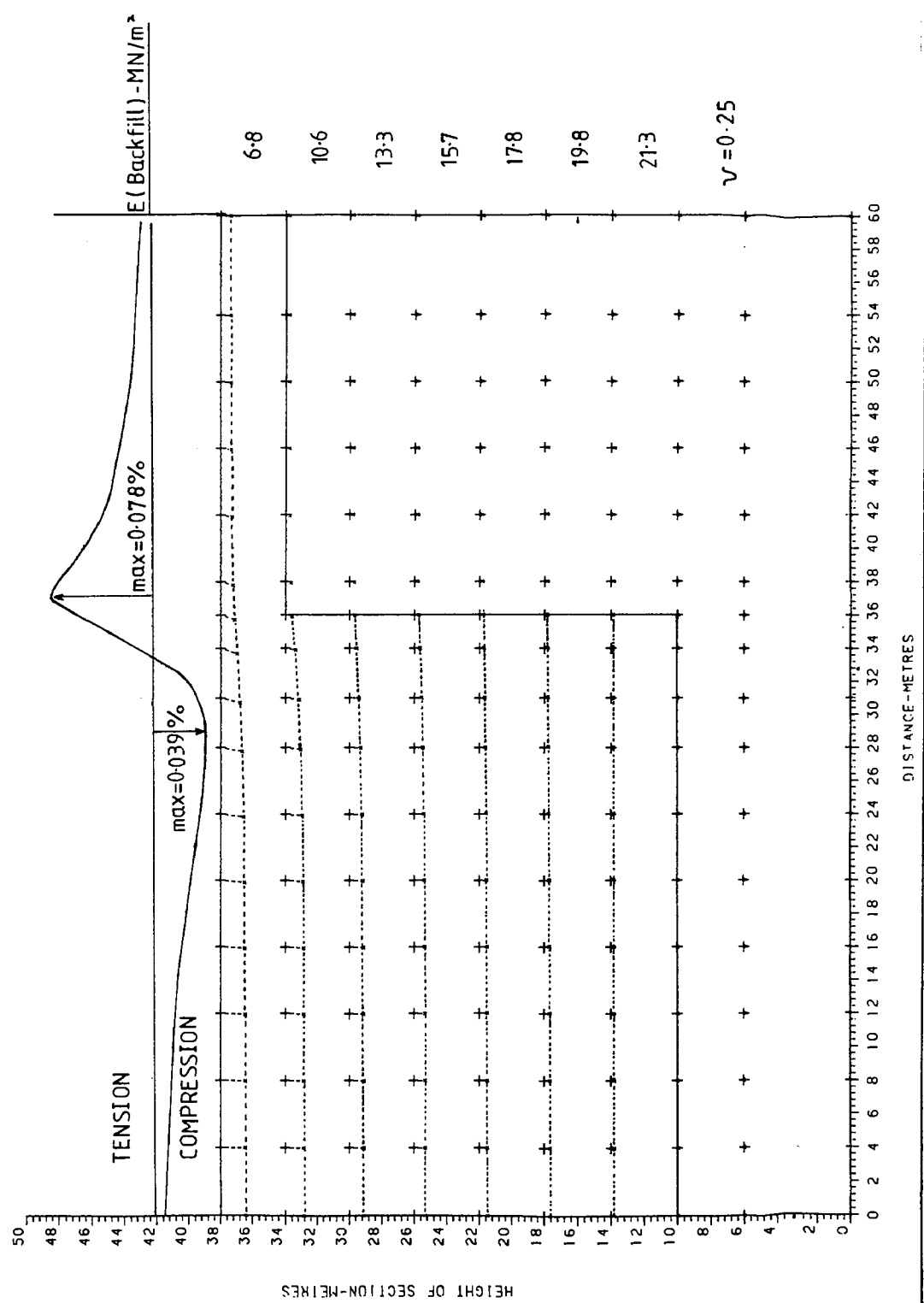

BASIC FINITE ELEMENT MODEL C1

FIGURE 6.3.3.

PLOT OF DISPLACEMENTS DUE TO SETTLEMENT OF FILL

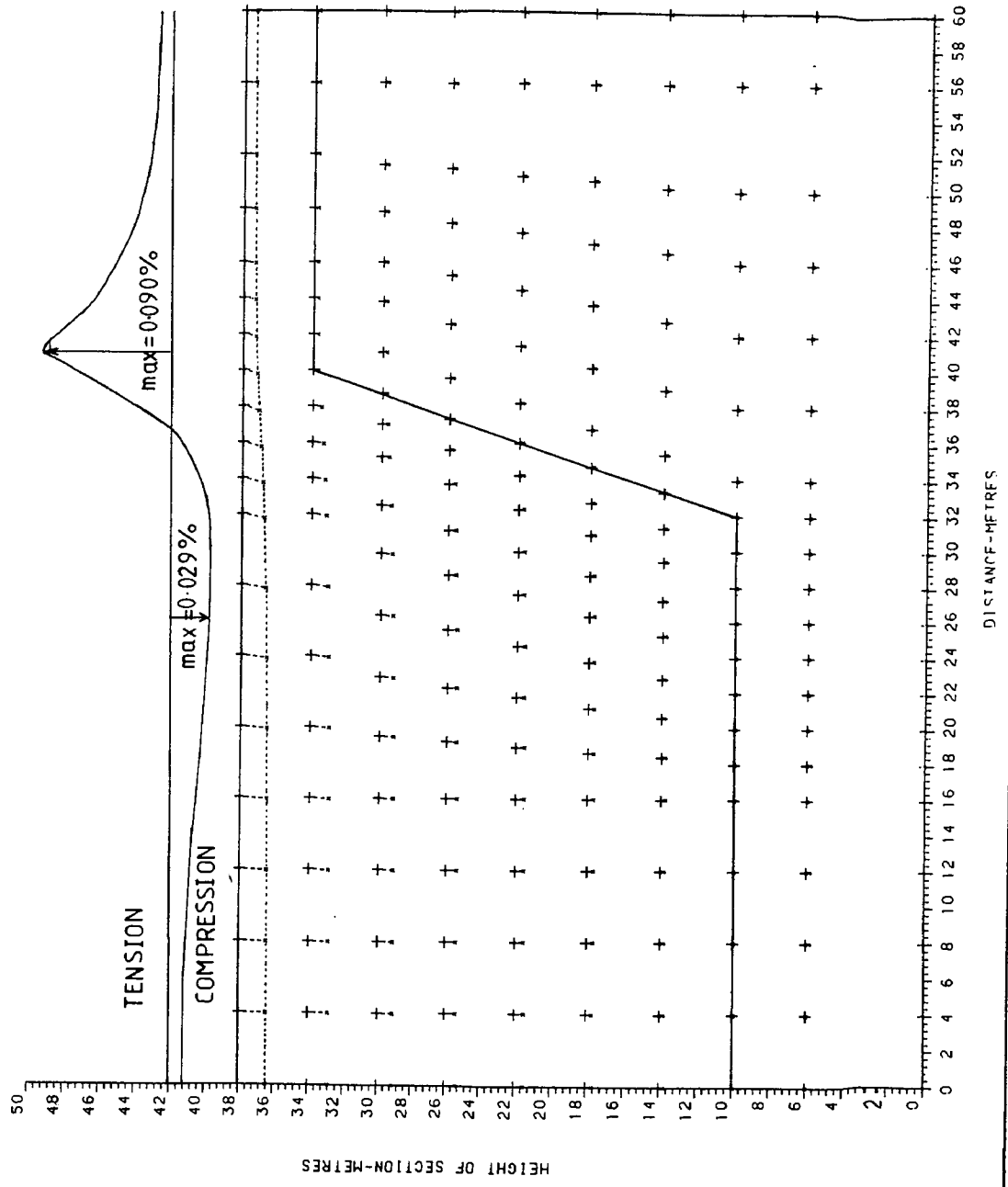

BASIC FINITE ELEMENT MODEL C2

FIGURE 6.3.4.

PLOT OF DISPLACEMENTS DUE TO SETTLEMENT OF FILL

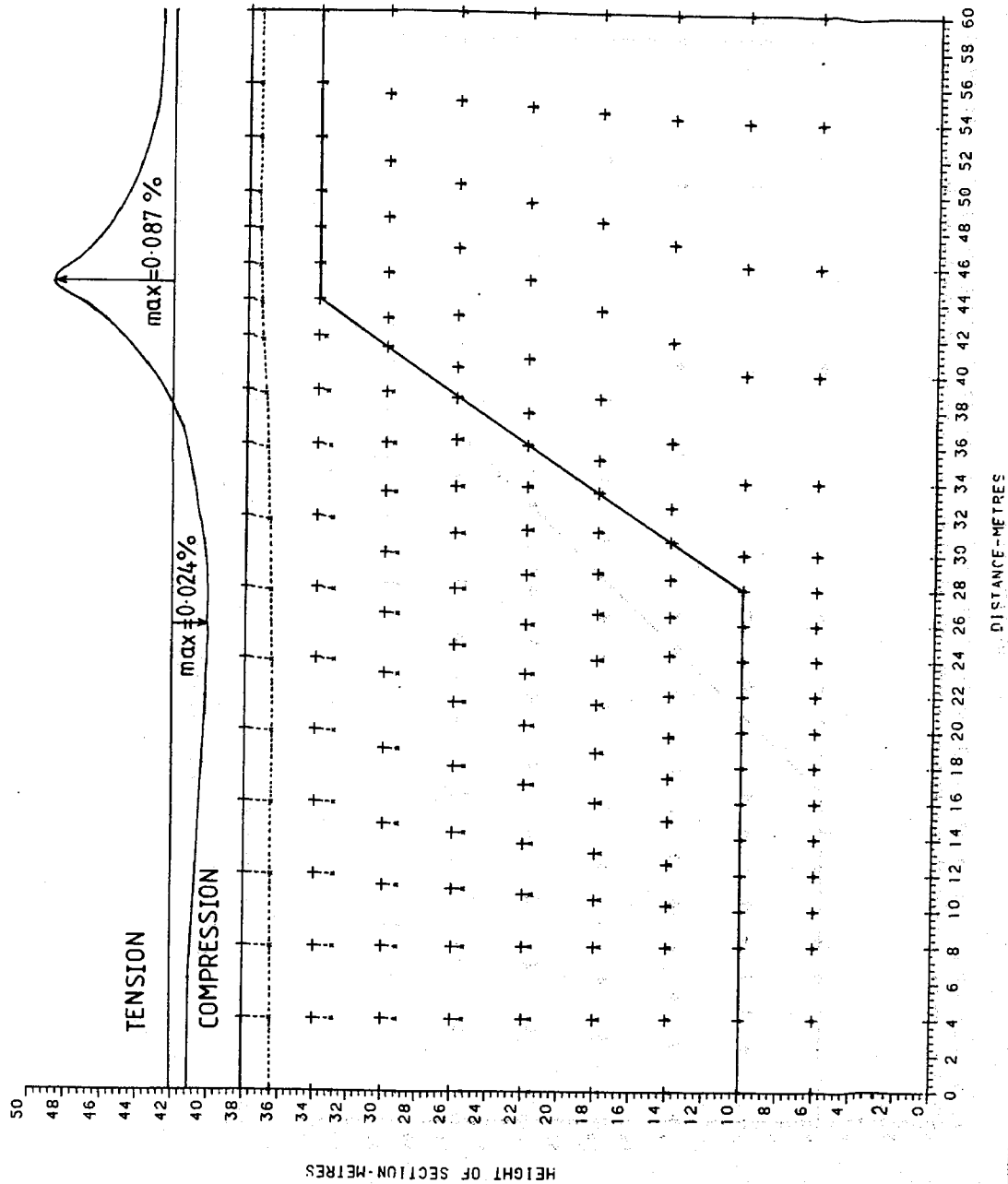

BASIC FINITE ELEMENT MODEL C.3

FIGURE 6.3.5.



PLOT OF DISPLACEMENTS DUE TO SETTLEMENT OF FILL

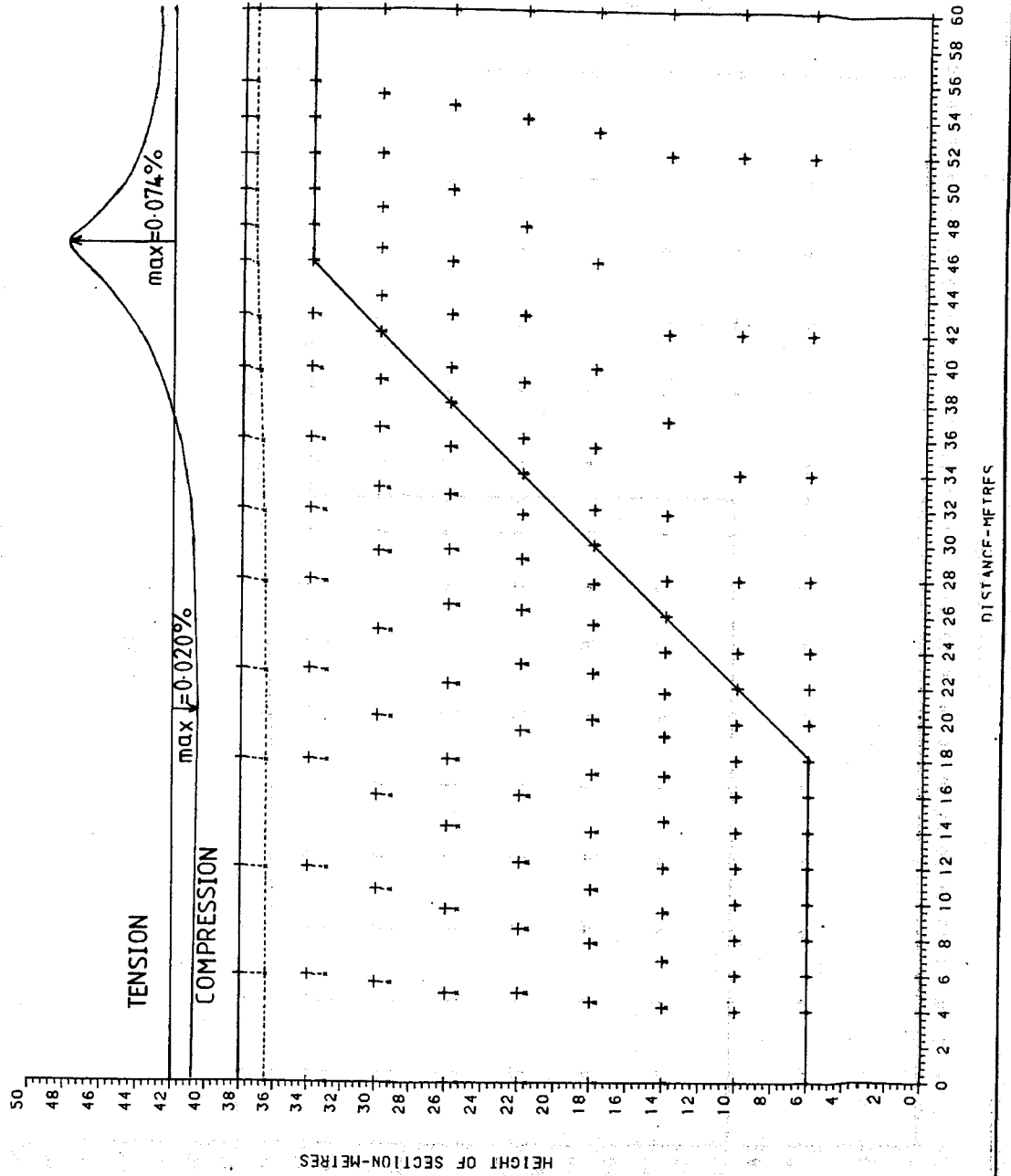

BASIC FINITE ELEMENT MODEL C4

FIGURE 6.3.6.

PLOT OF DISPLACEMENTS DUE TO SETTLEMENT OF FILL  
(SCALE FOR DISPLACEMENTS 1:3)

$\nu = 0.25$

$E(\text{Backfill}) = \text{MN/m}^2$

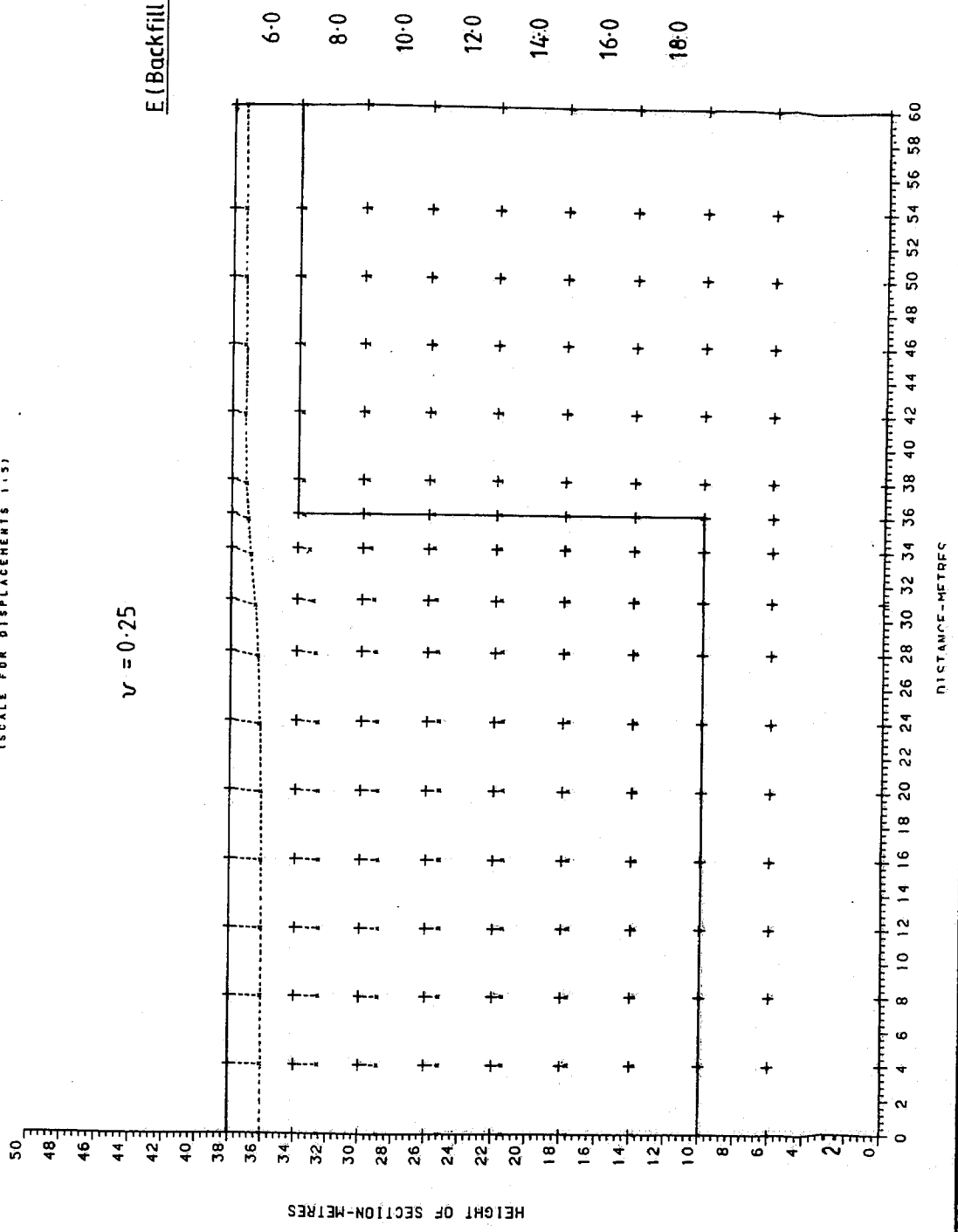

BASIC FINITE ELEMENT MODEL C12

FIGURE 6.3.7.

PLOT OF DISPLACEMENTS DUE TO SETTLEMENT OF FILL  
(SCALE FOR DISPLACEMENTS 1:5)

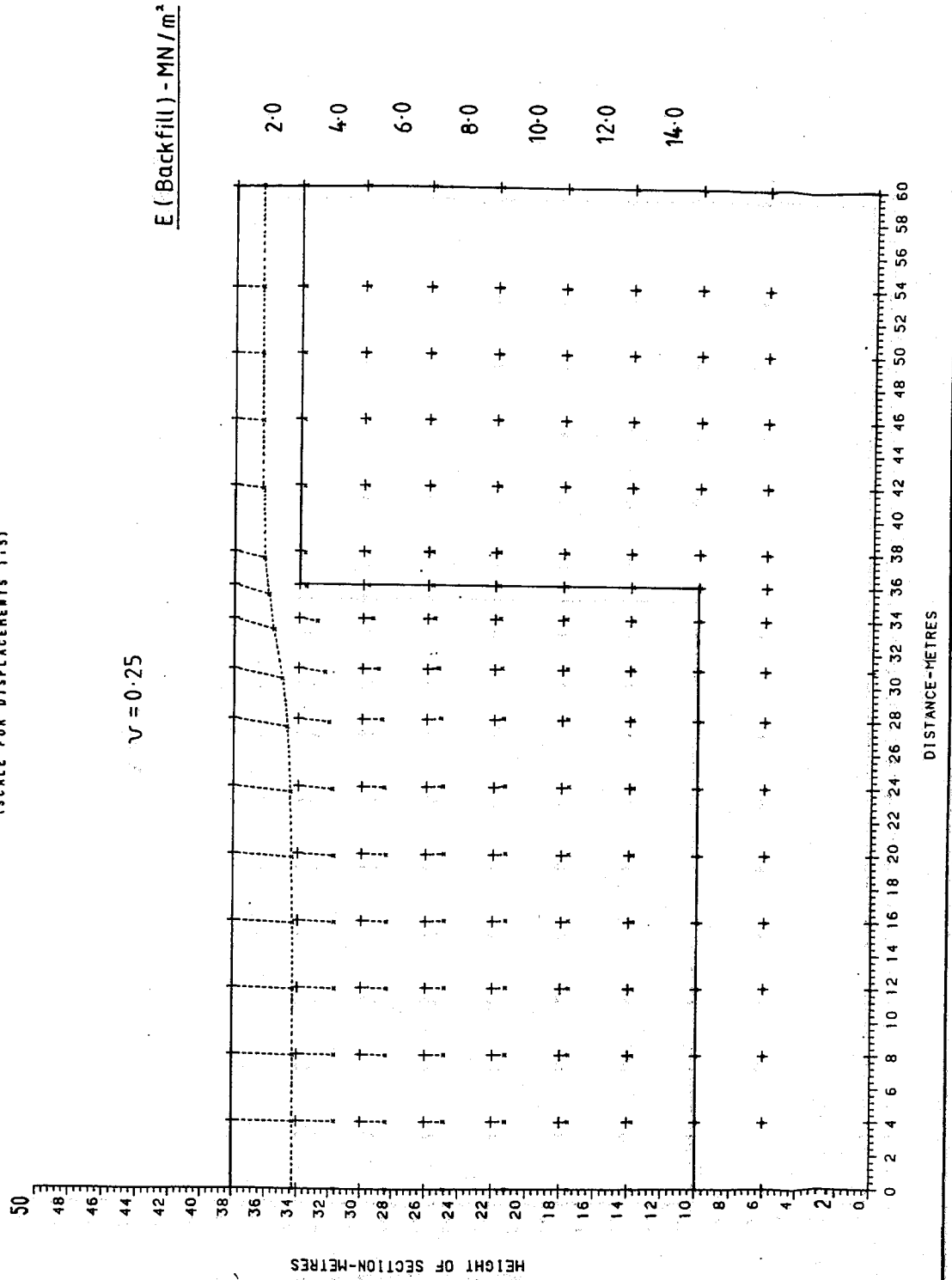

BASIC FINITE ELEMENT MODEL C13

FIGURE 6-3-8

FLUT OF DISPLACEMENTS DUE TO SETTLEMENT OF FILL

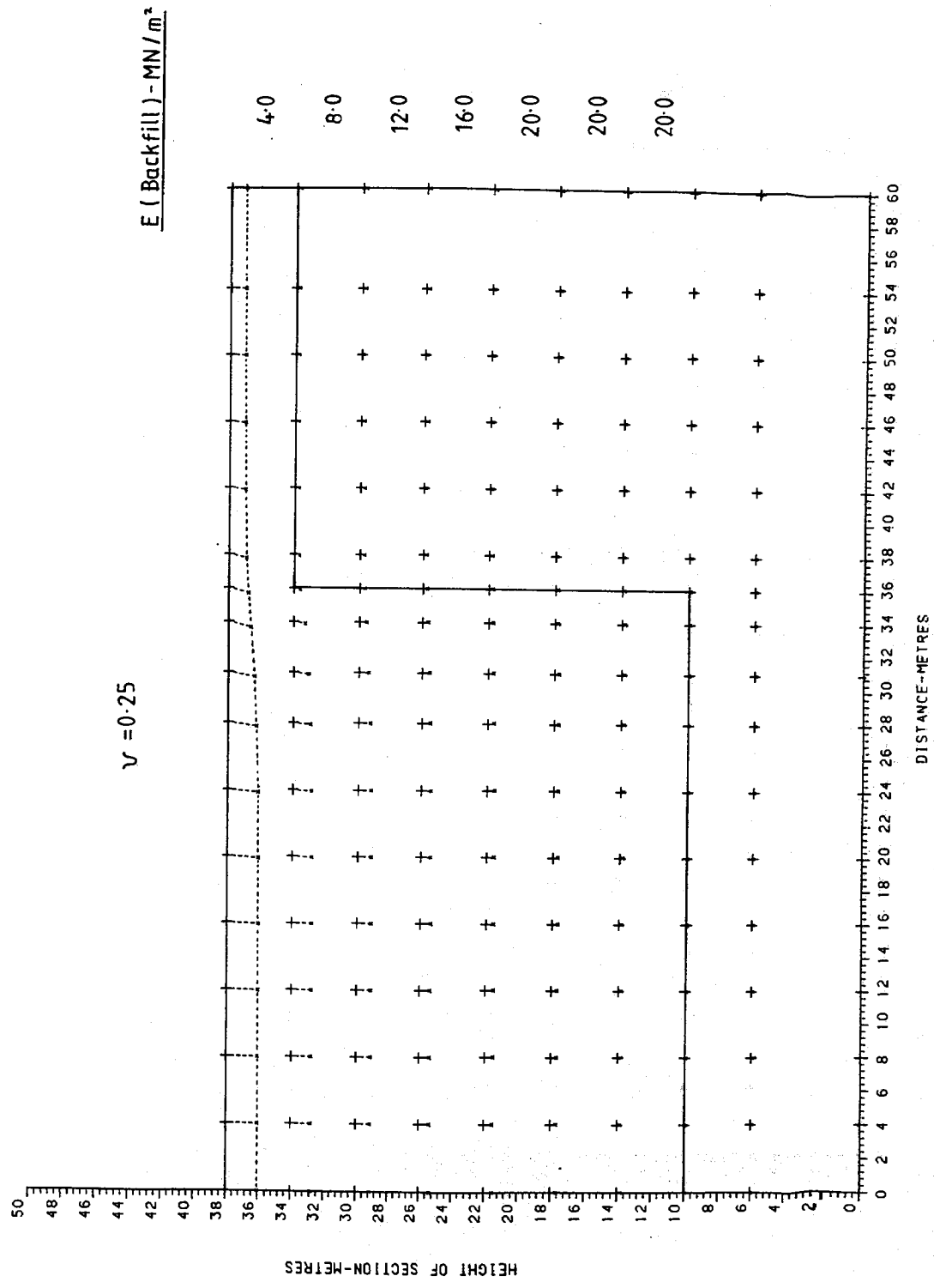

BASIC FINITE ELEMENT MODEL C14

FIGURE 6-3-9.

PLOT OF DISPLACEMENTS DUE TO SETTLEMENT OF FILL  
(SCALE FOR DISPLACEMENTS 1:5)

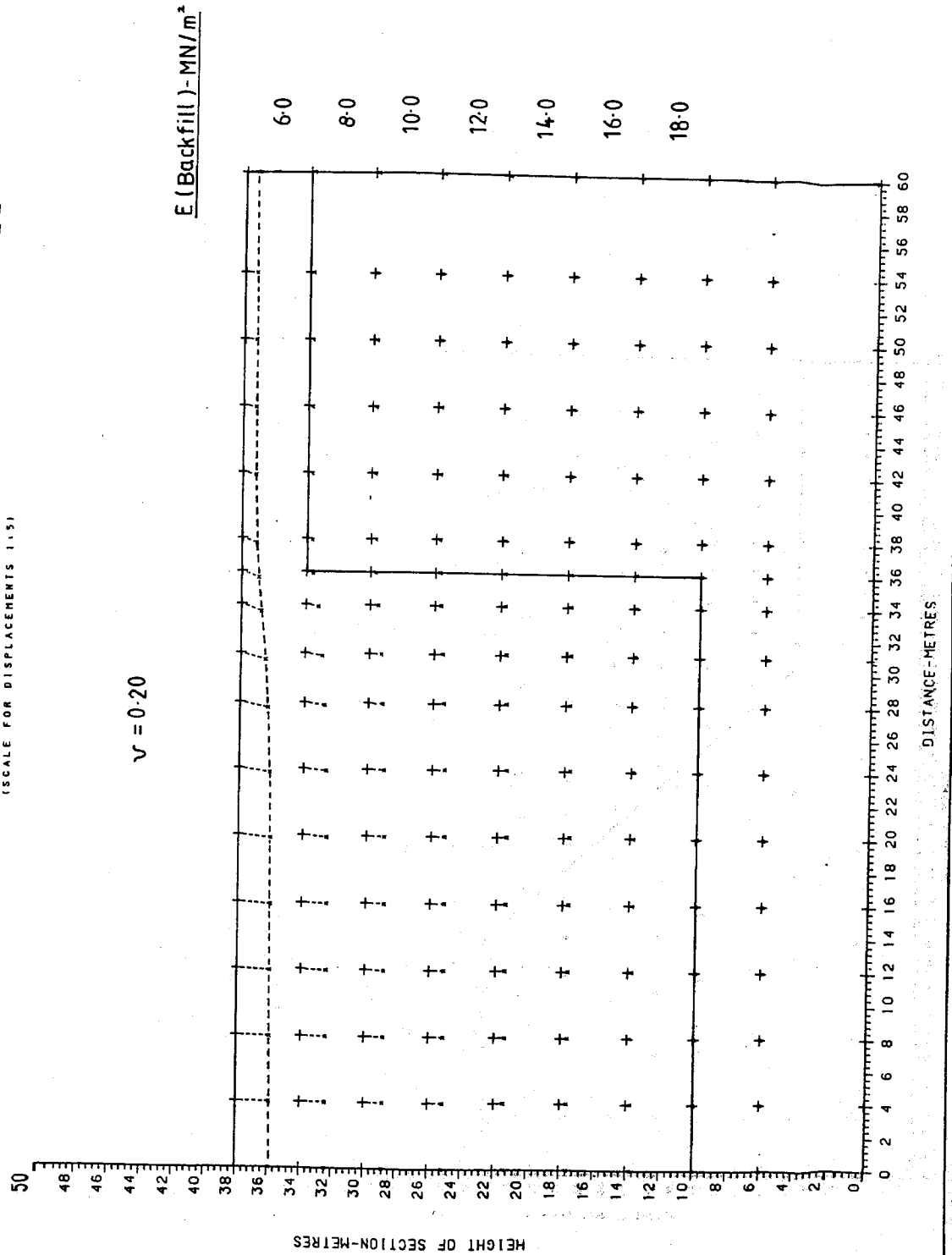

BASIC FINITE ELEMENT MODEL C15

FIGURE 6.3.10.

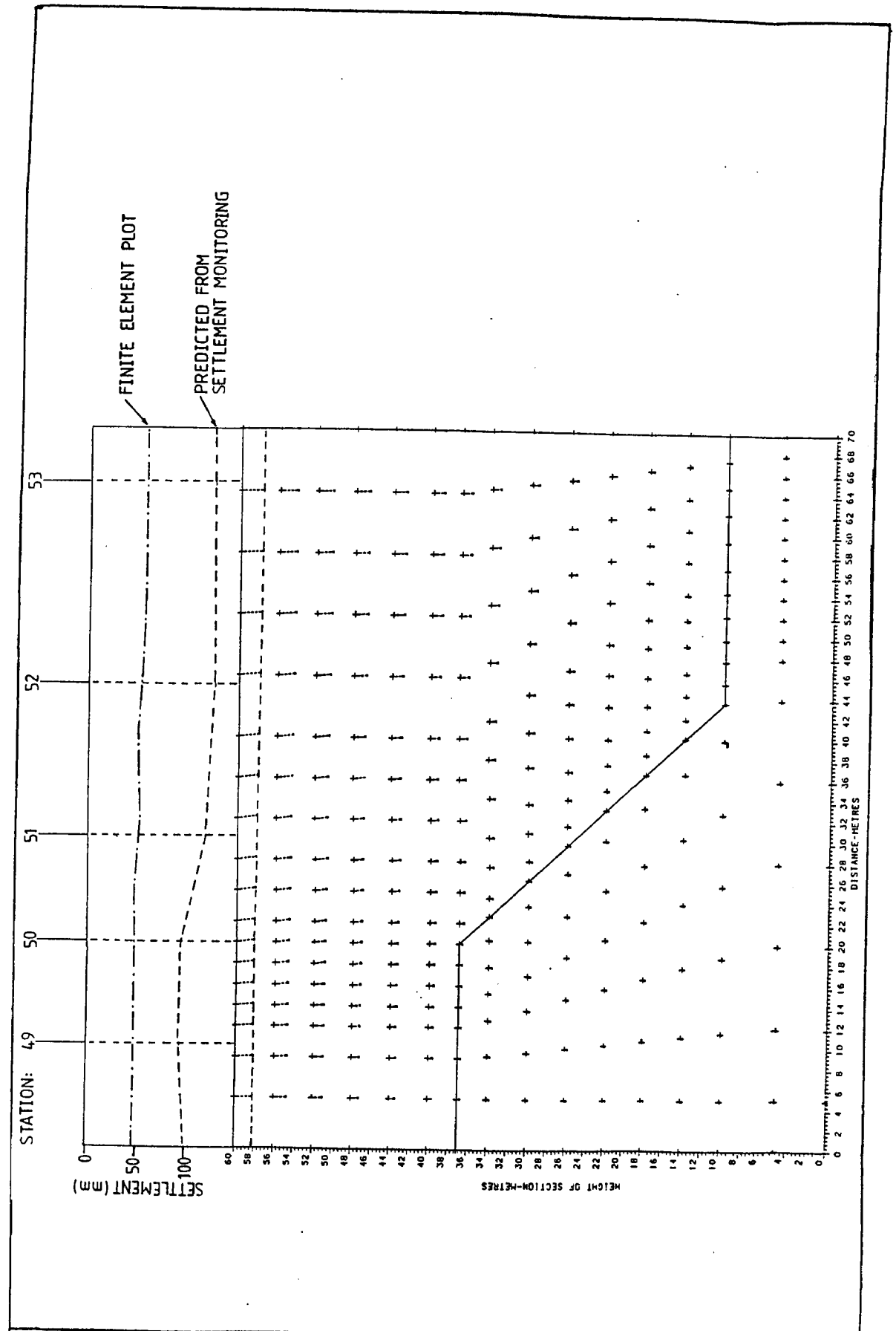

MODEL E1 - INCLUDING SURFACE SETTLEMENT & STATIONS  
FROM COMPARATIVE REAL PROFILE.

FIGURE 6.4.1

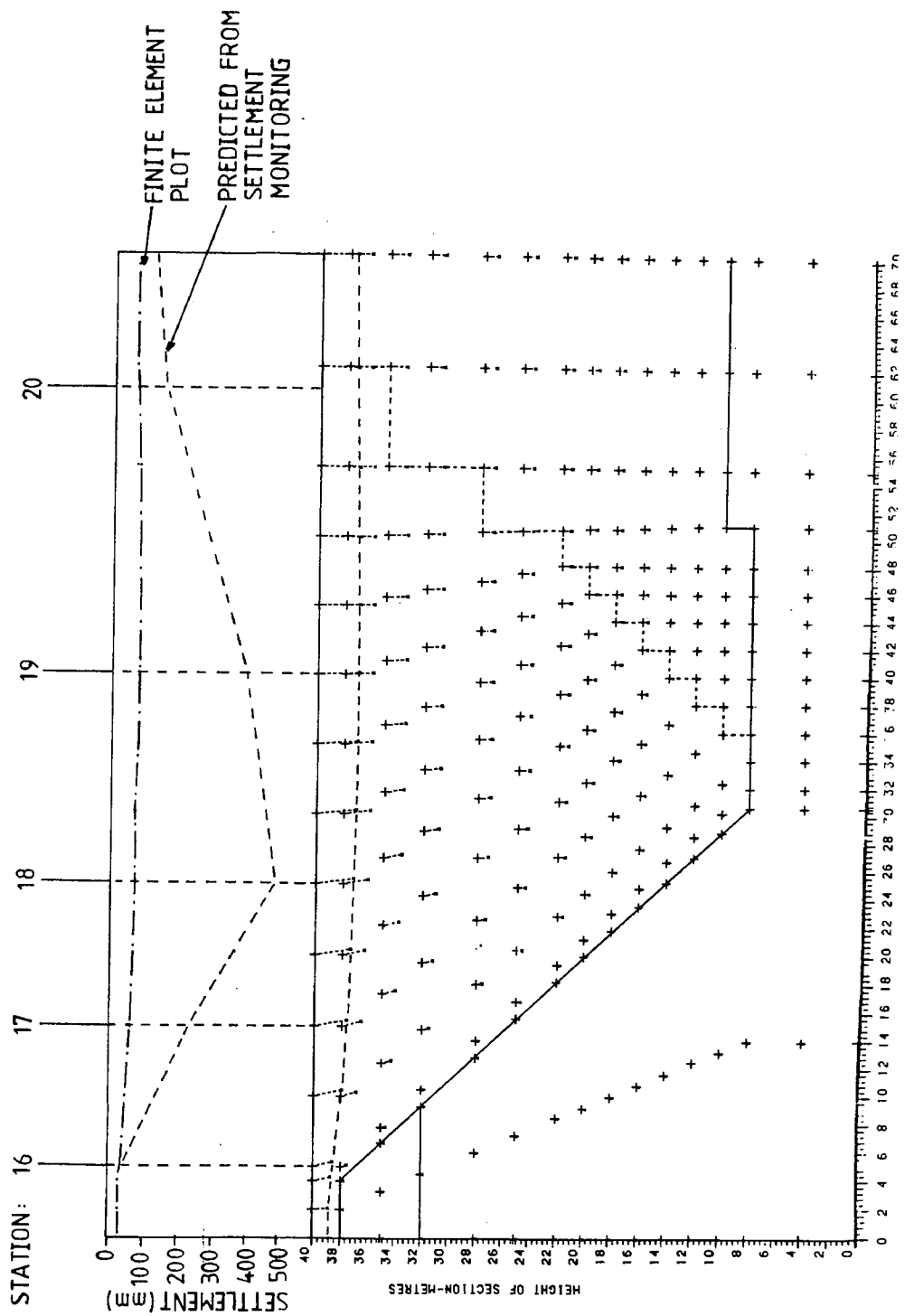

MODEL E3- INCLUDING SURFACE SETTLEMENT & STATIONS FROM COMPARATIVE REAL PROFILE.

FIGURE 6-4-2.

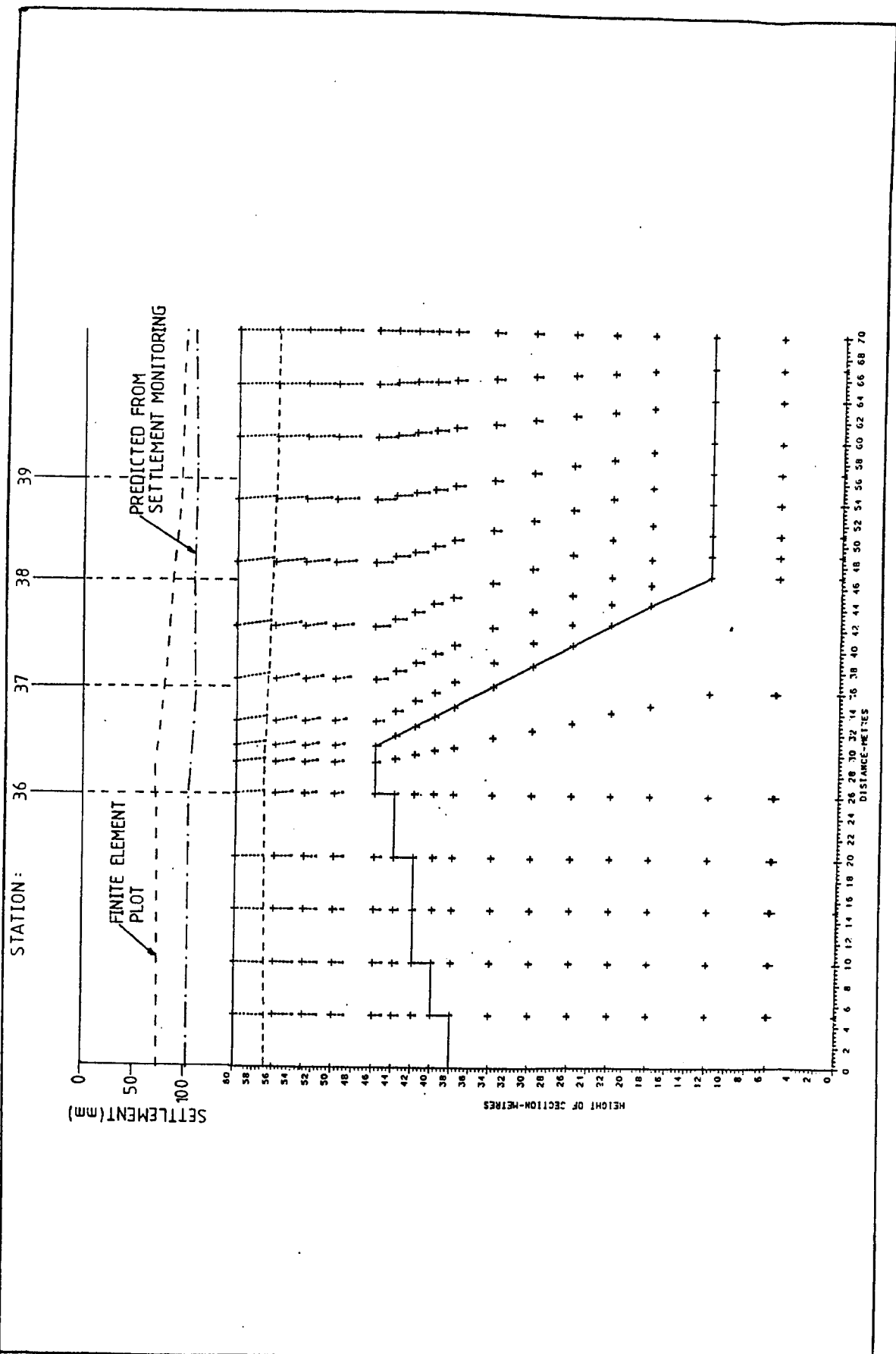

MODEL E7- INCLUDING SURFACE SETTLEMENT & STATIONS FROM COMPARATIVE REAL PROFILE.

FIGURE 6.4.3.



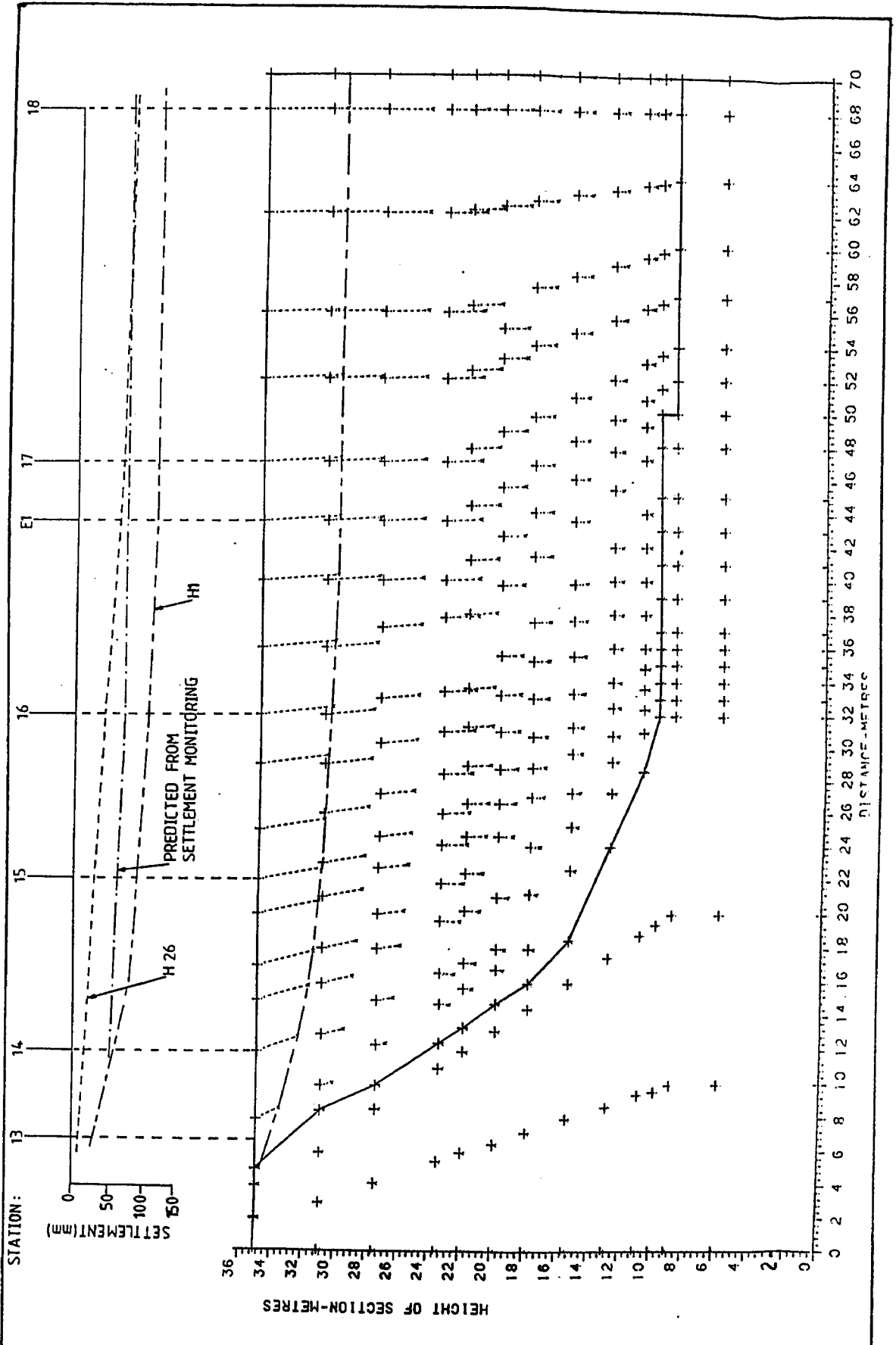

MODEL H1 - WITH SETTLEMENT PROFILES FOR H1, H26 AND AS PREDICTED BY SETTLEMENT MONITORING.

FIGURE 6.4.4.

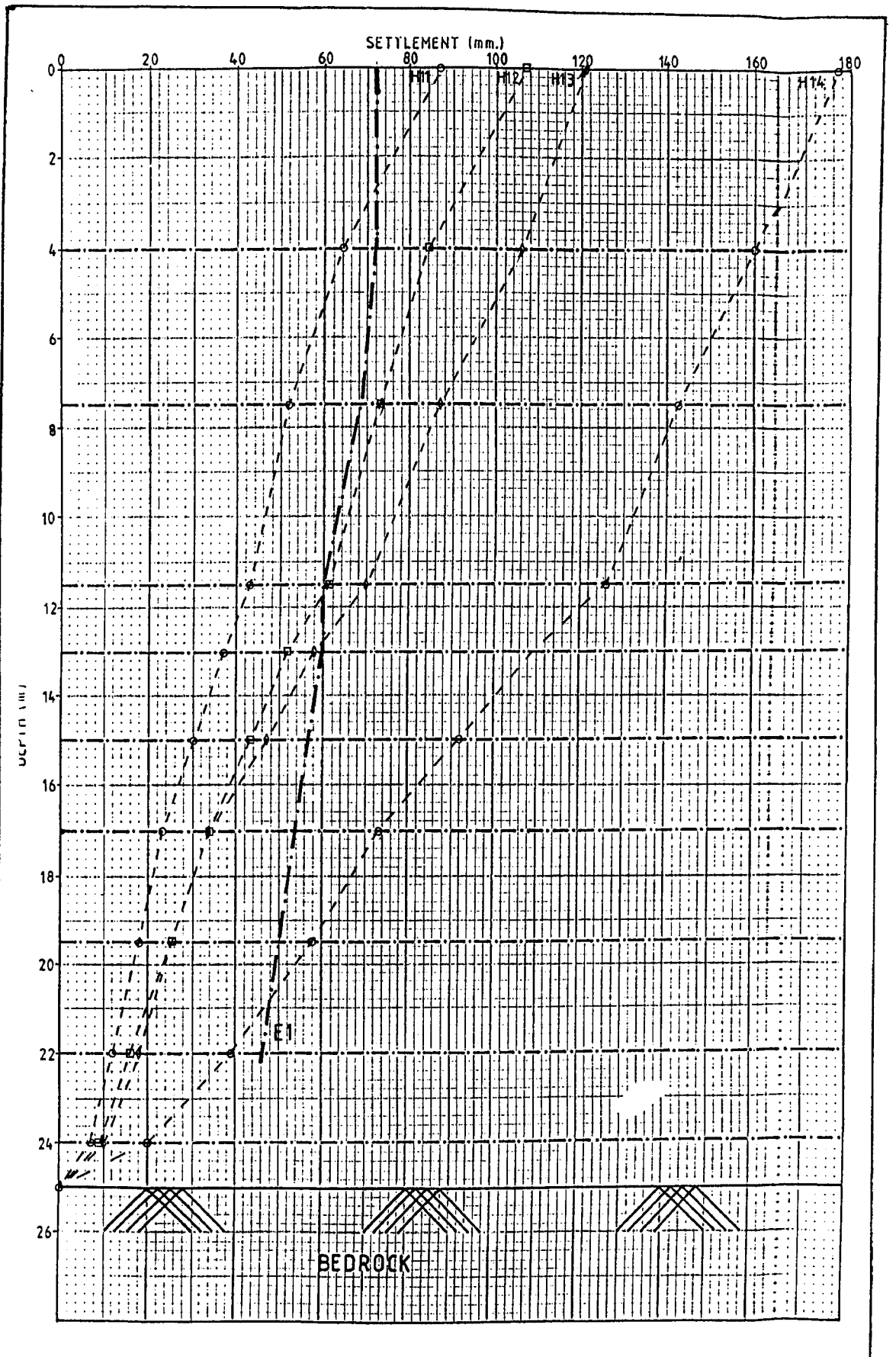

FINITE ELEMENT MODEL H1 - DATA VARIATION SETS H11-H14.

FIGURE 6-4-5.

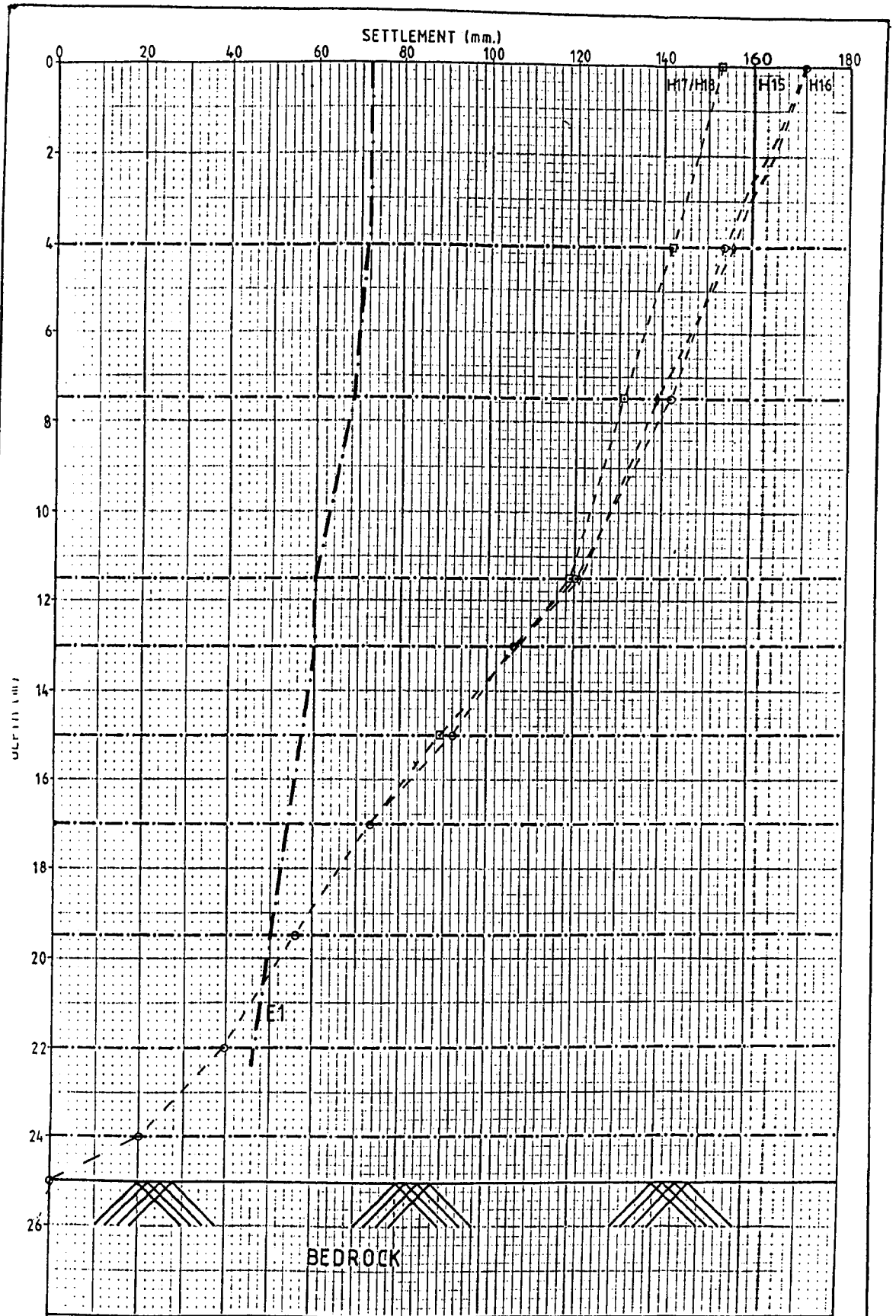

FINITE ELEMENT MODEL H1 - DATA VARIATION SETS H15-H18.

FIGURE 6.4.6.

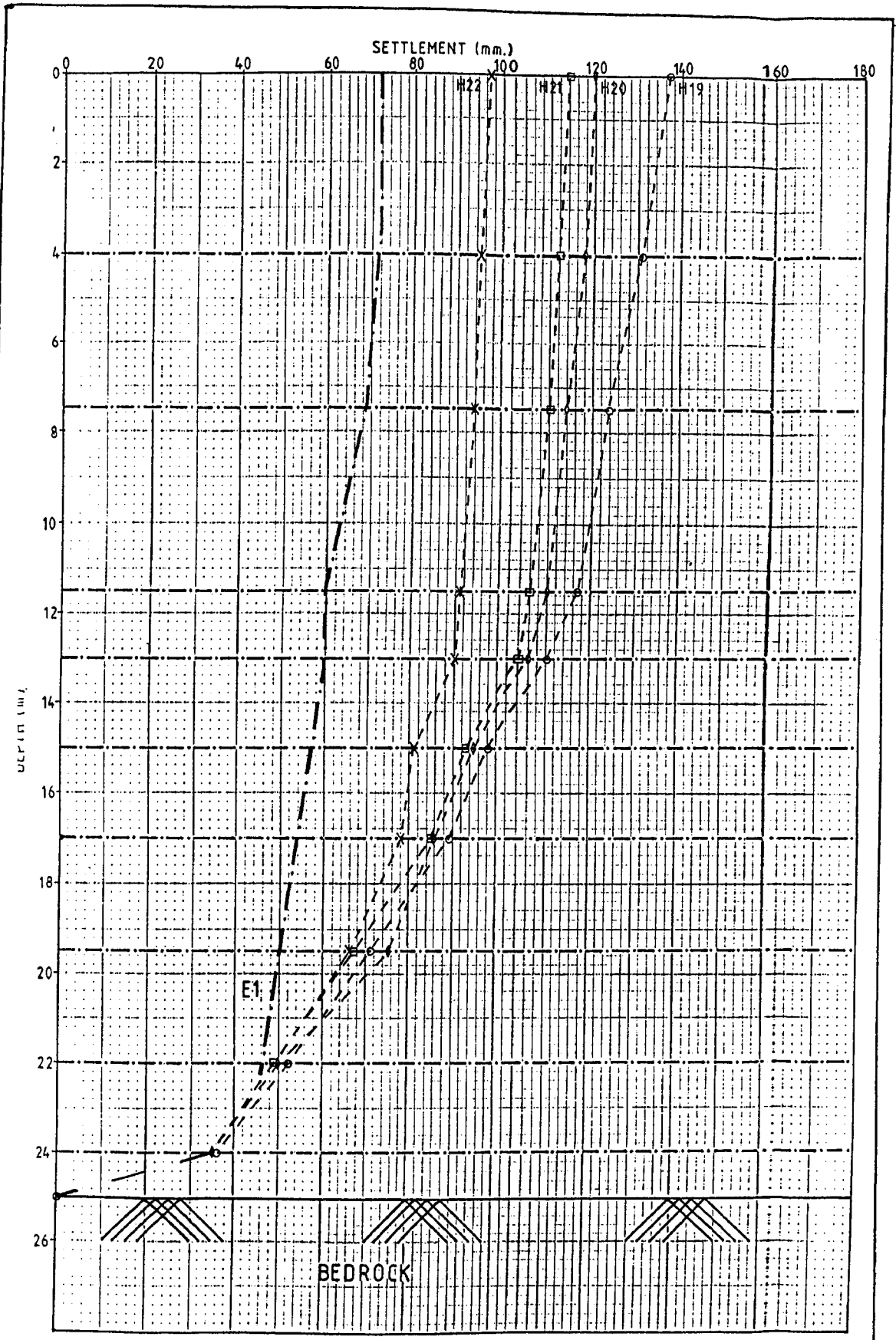

FINITE ELEMENT MODEL H1 - DATA VARIATION SETS H19 -H22.

FIGURE 6-4-7.

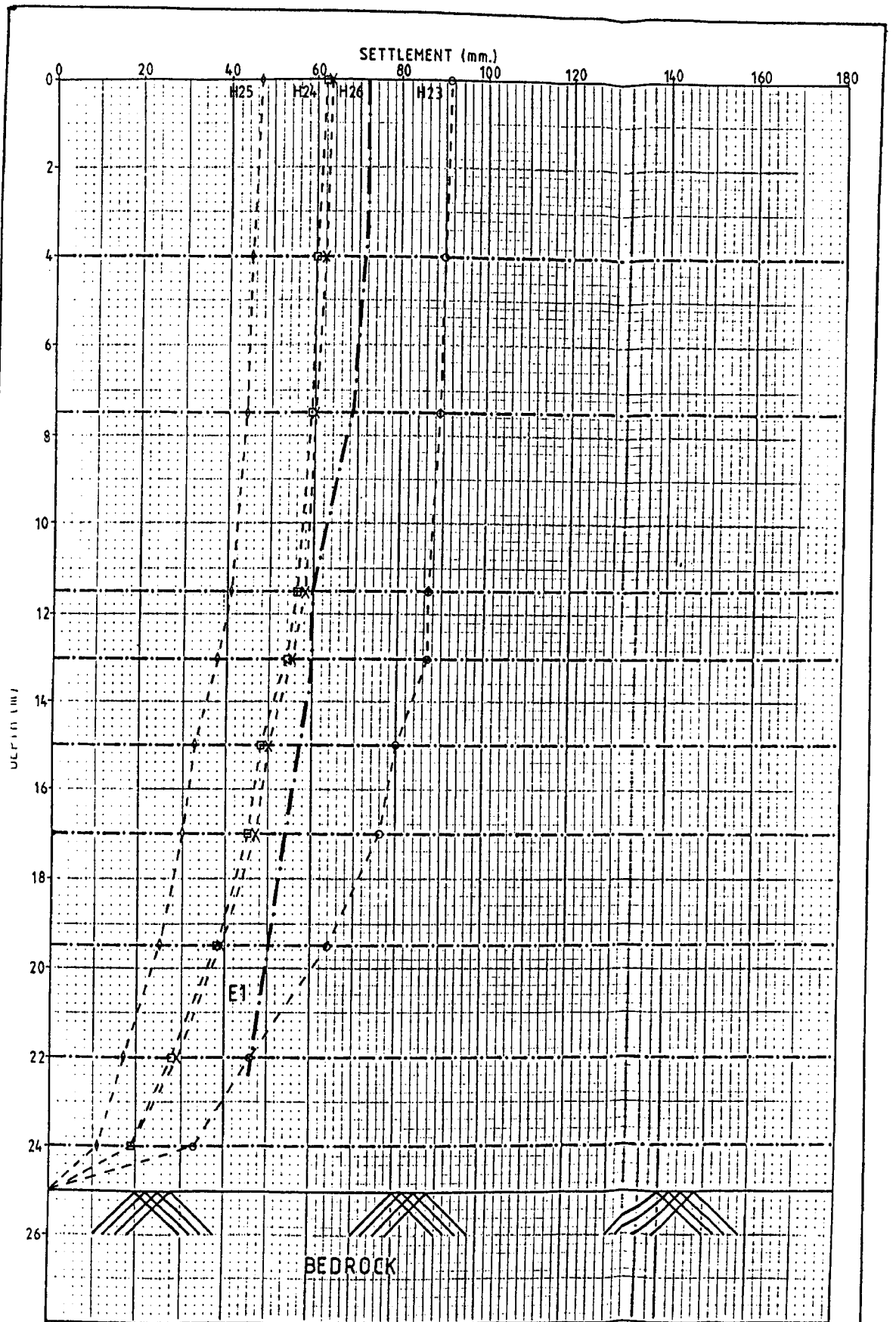

FINITE ELEMENT MODEL H1 - DATA VARIATION SETS H23-H26.

FIGURE 6-4-8.

YOUNG'S MODULUS (MN/m<sup>2</sup>)

Depth to Midpoint in Layer (m)	2.00	5.75	9.50	12.25	14.00	16.00	18.25	20.75	23.00	24.50	25.50
<u>Model</u> H1	2.0	3.9	5.8	7.2	8.0	9.2	10.2	11.4	12.4	13.1	13.6
H11	3.0	6.0	8.0	9.5	10.5	11.5	12.5	14.0	15.0	16.0	18.0
H12	3.0	6.0	6.0	8.0	8.0	8.0	8.0	8.0	10.0	10.0	10.0
H13	4.0	4.0	4.0	6.0	6.0	6.0	8.0	8.0	10.0	10.0	10.0
H14	4.0	4.0	4.0	4.0	4.0	4.0	4.0	4.0	4.0	4.0	4.0
H15	4.0	3.5	5.0	5.0	5.0	4.0	4.0	4.0	4.0	4.0	4.0
H16	5.0	4.0	4.0	4.5	4.5	4.0	4.0	4.0	4.0	4.0	4.0
H17	6.0	6.0	6.0	6.0	4.0	4.0	4.0	4.0	4.0	4.0	4.0
H18	6.0	6.0	6.0	5.0	5.0	4.0	4.0	4.0	4.0	4.0	4.0
H19	10.0	10.0	10.0	8.0	8.0	6.0	4.0	4.0	4.0	2.0	2.0
H20	20.0	20.0	20.0	10.0	10.0	6.0	4.0	4.0	4.0	2.0	2.0
H21	30.0	30.0	20.0	15.0	10.0	6.0	4.0	4.0	4.0	2.0	2.0
H22	40.0	40.0	30.0	20.0	15.0	10.0	6.0	4.0	4.0	2.0	2.0
H23	50.0	50.0	40.0	30.0	20.0	10.0	6.0	4.0	4.0	2.0	2.0
H24	40.0	40.0	30.0	20.0	20.0	15.0	10.0	8.0	6.0	4.0	4.0
H25	40.0	40.0	30.0	20.0	20.0	15.0	15.0	10.0	10.0	8.0	6.0
H26	40.0	40.0	30.0	20.0	20.0	15.0	10.0	8.0	6.0	4.0	3.0

YOUNGS MODULUS VALUES FOR H1 VARIATIONS.

FIGURE 6-4-9.

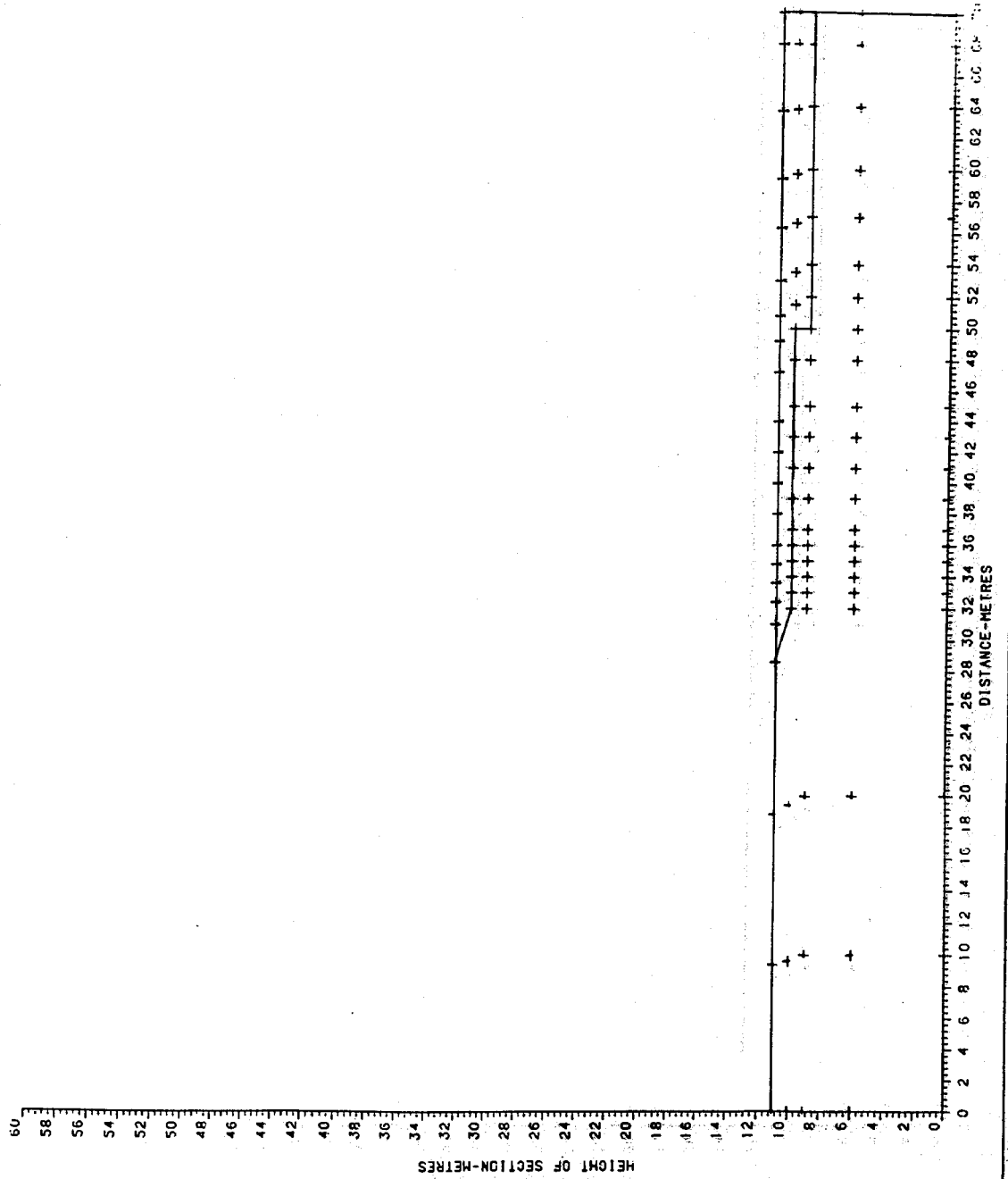

BUILD UP OF MODEL H1 (H100)

FIGURE 6-4-10.

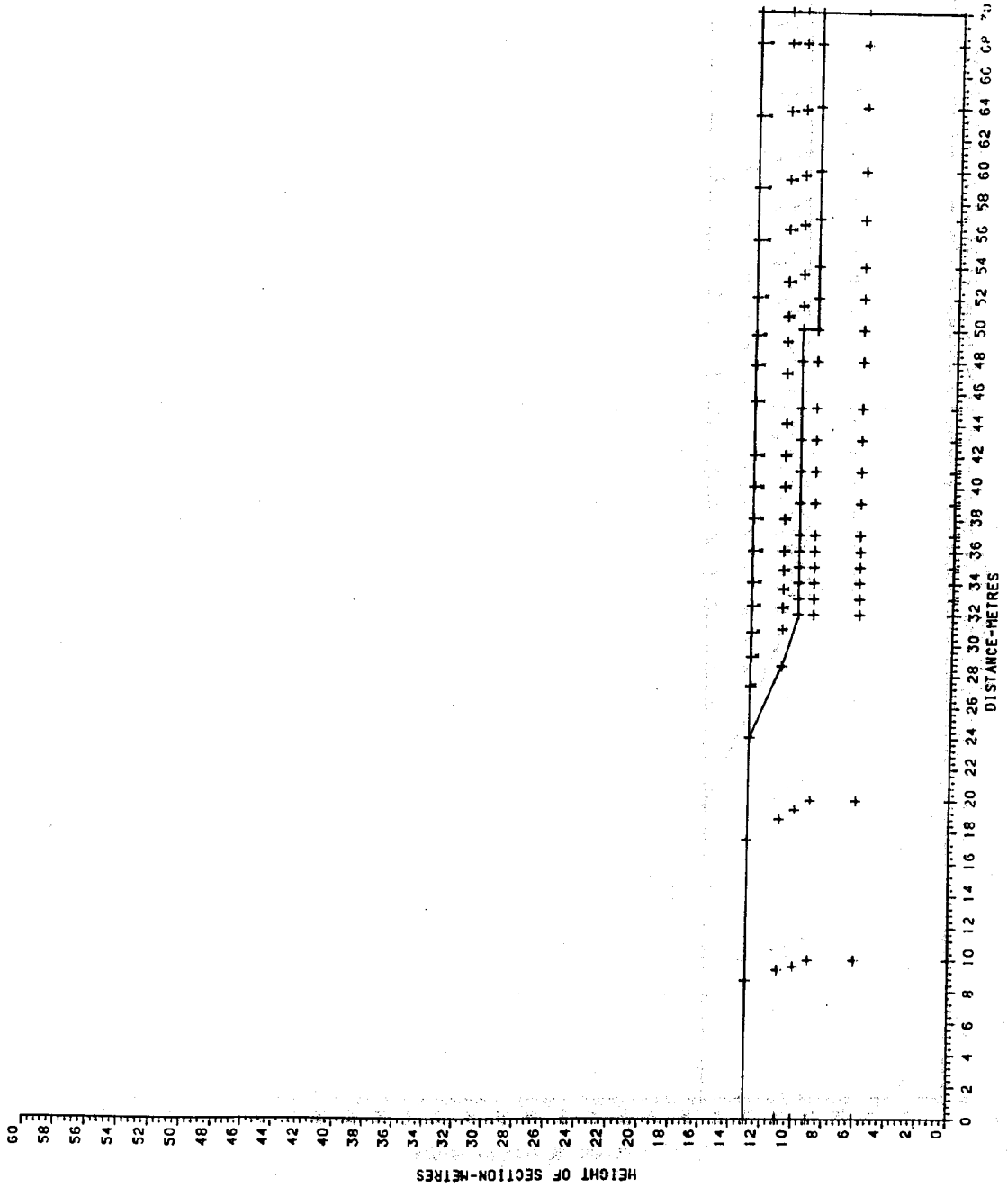

BUILD UP OF MODEL H1 (H101)

FIGURE 6.4.11.



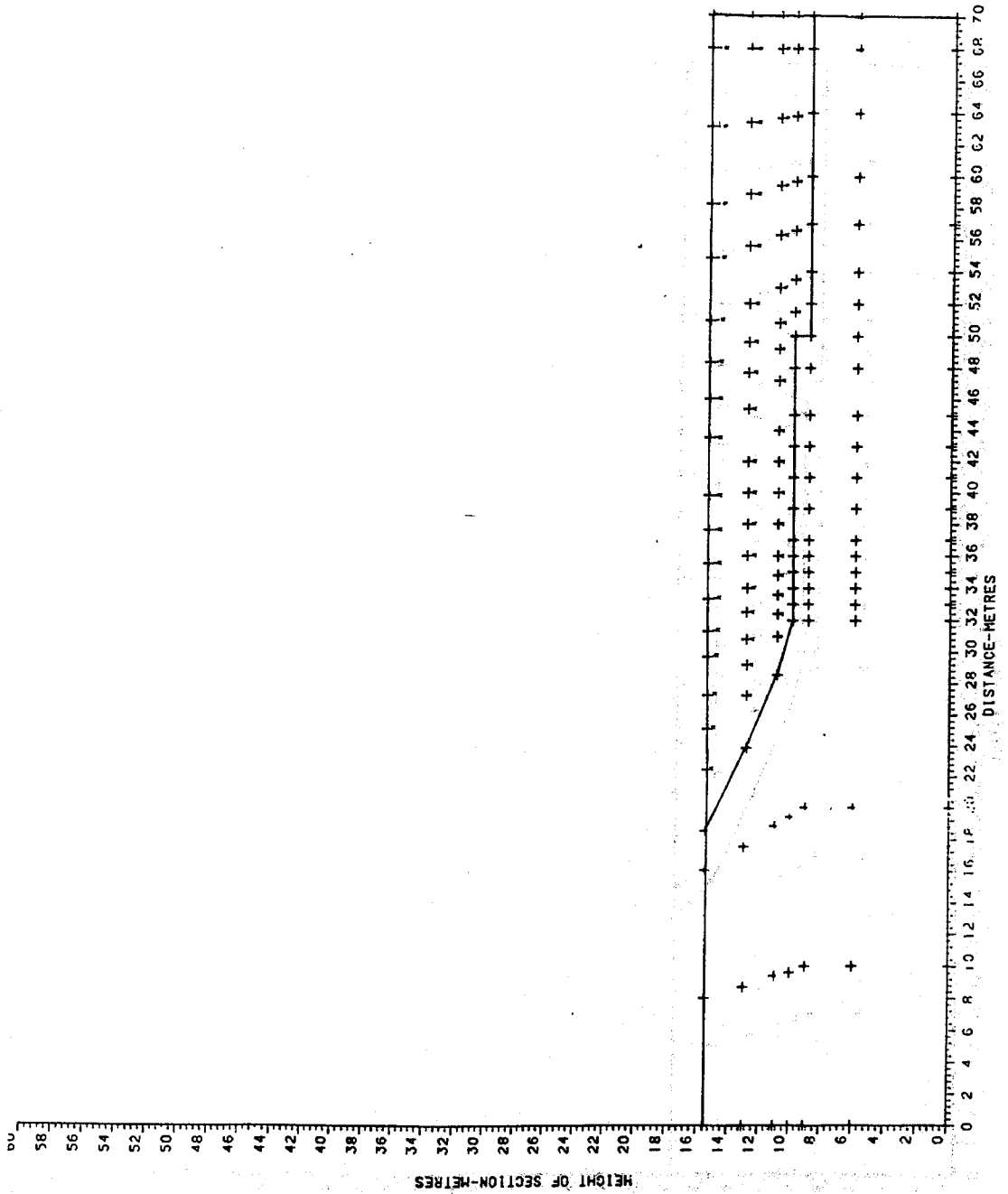

BUILD UP OF MODEL H1 (H102)

FIGURE 6-4-12.

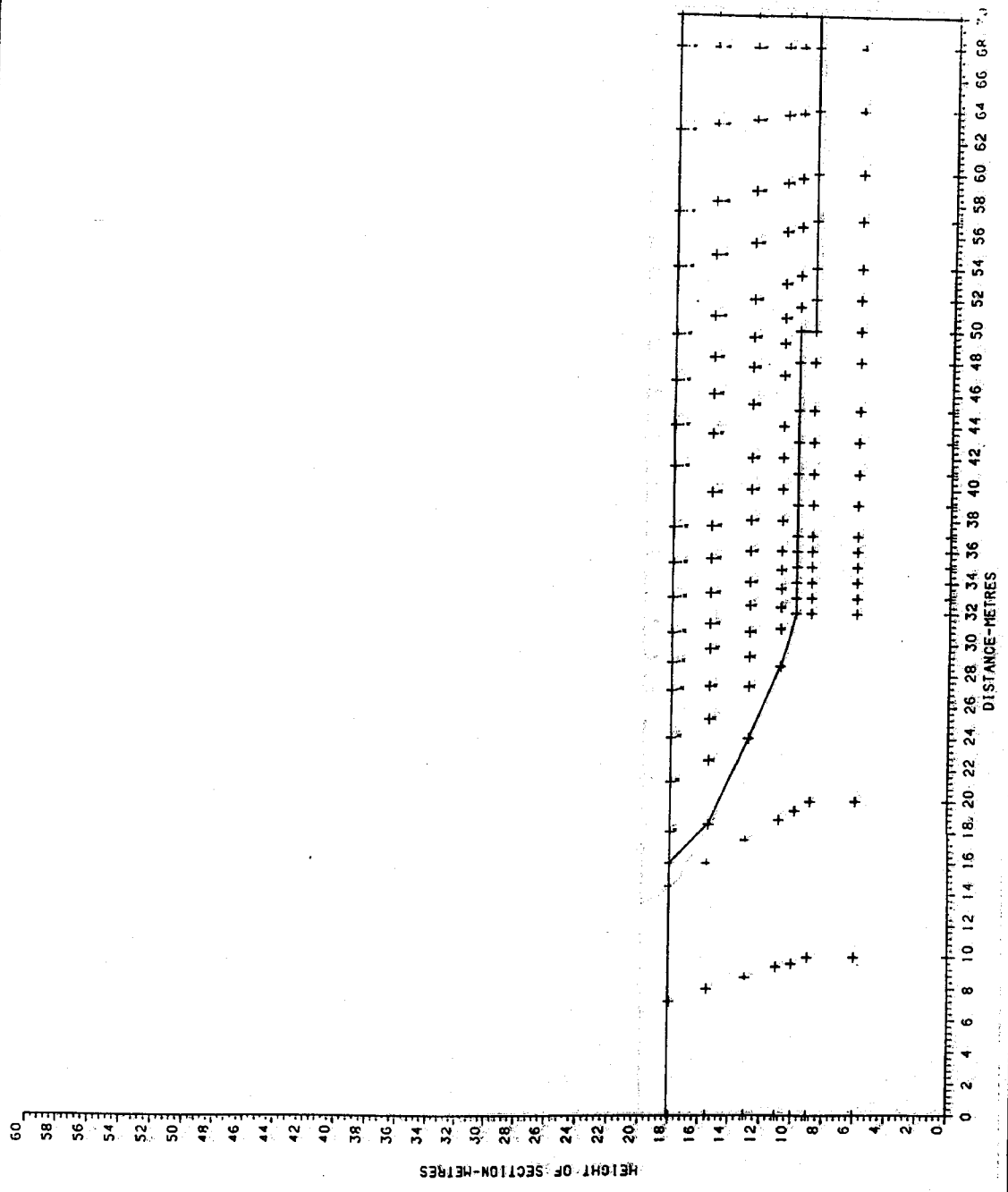

BUILD UP OF MODEL M1 (M103)

FIGURE 6-4-13.

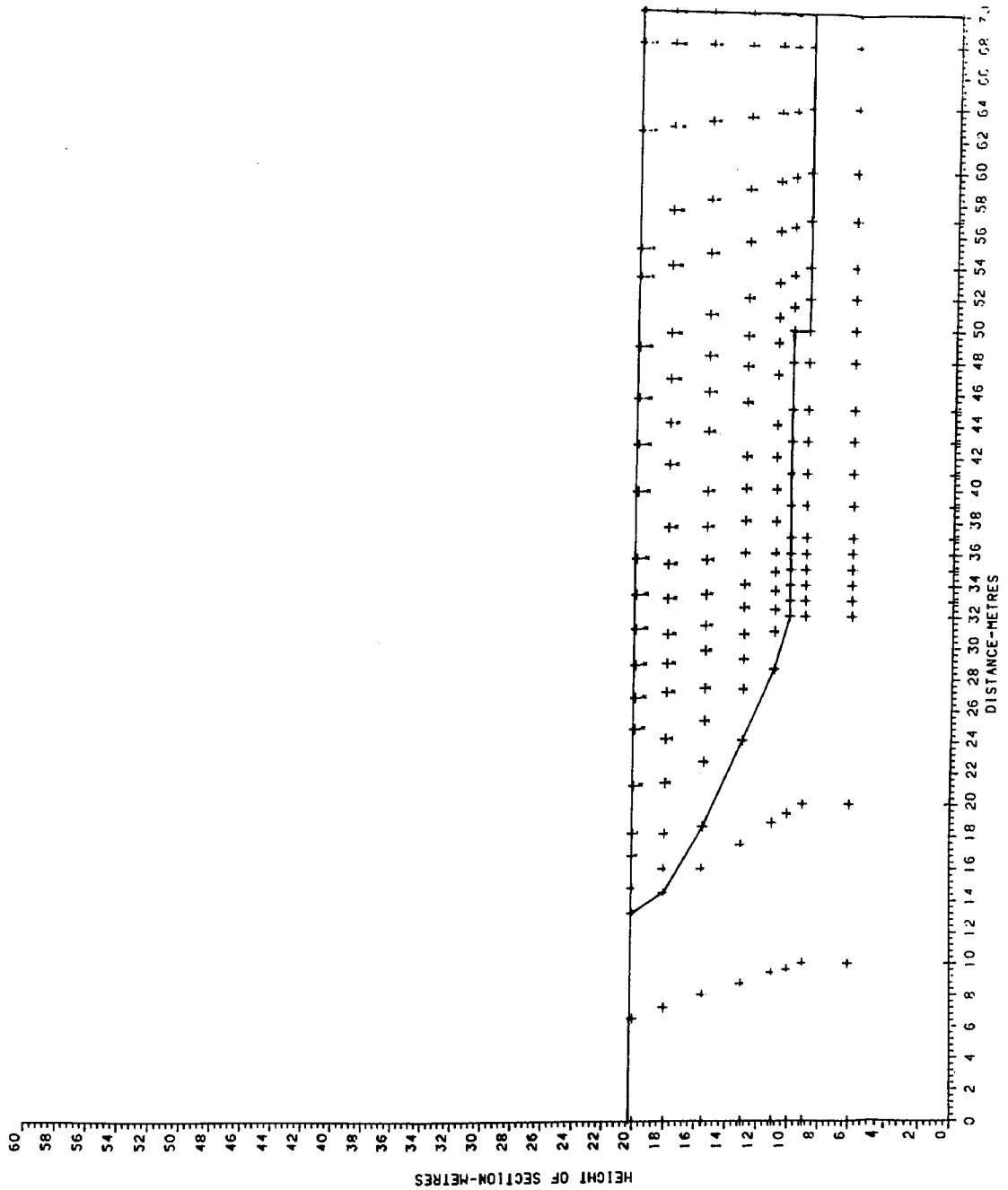

BUILD UP OF MODEL H1 (H104)

FIGURE 6-4.14.

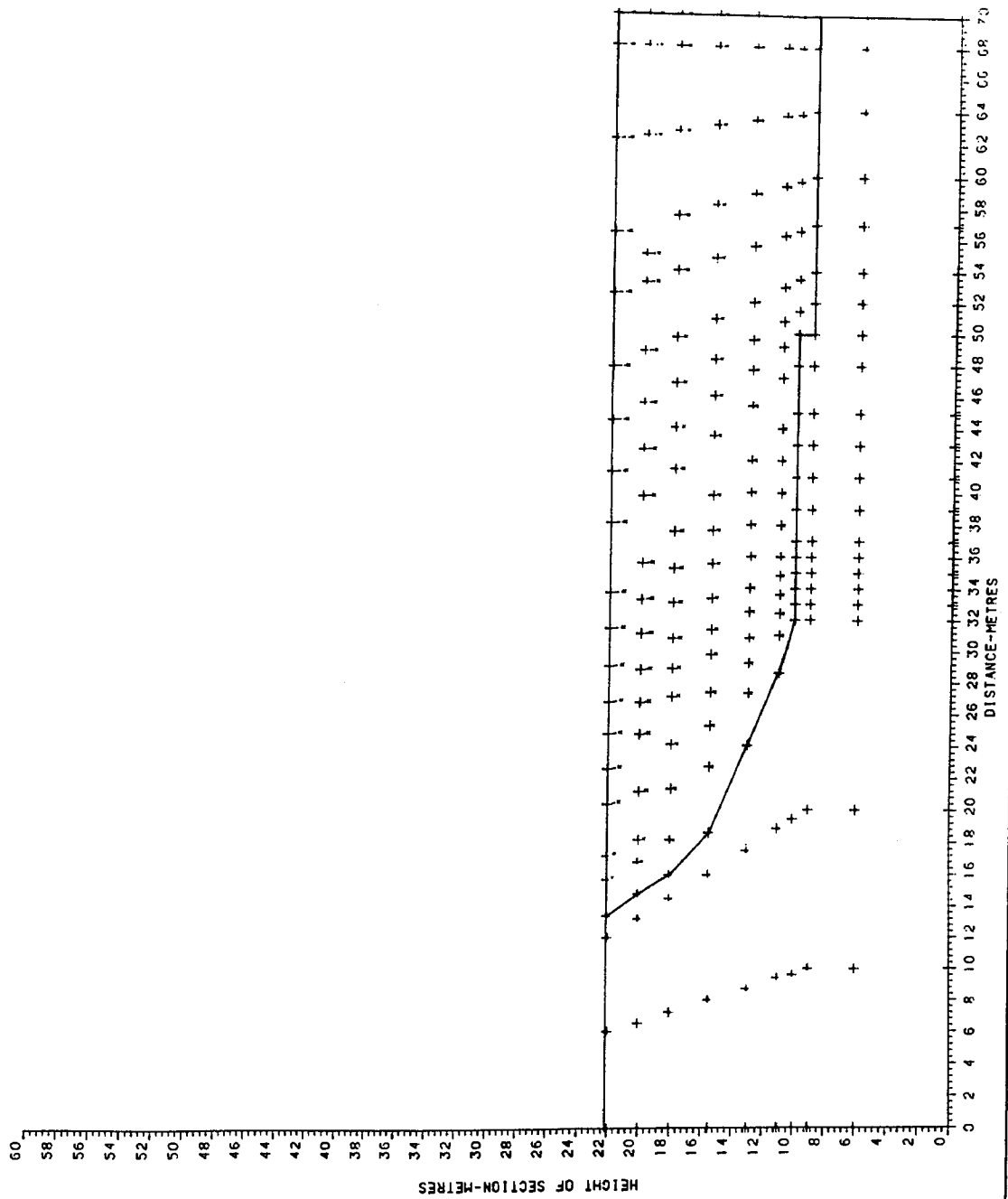

BUILD UP OF MODEL H1 (H105)

FIGURE 6-4-15.

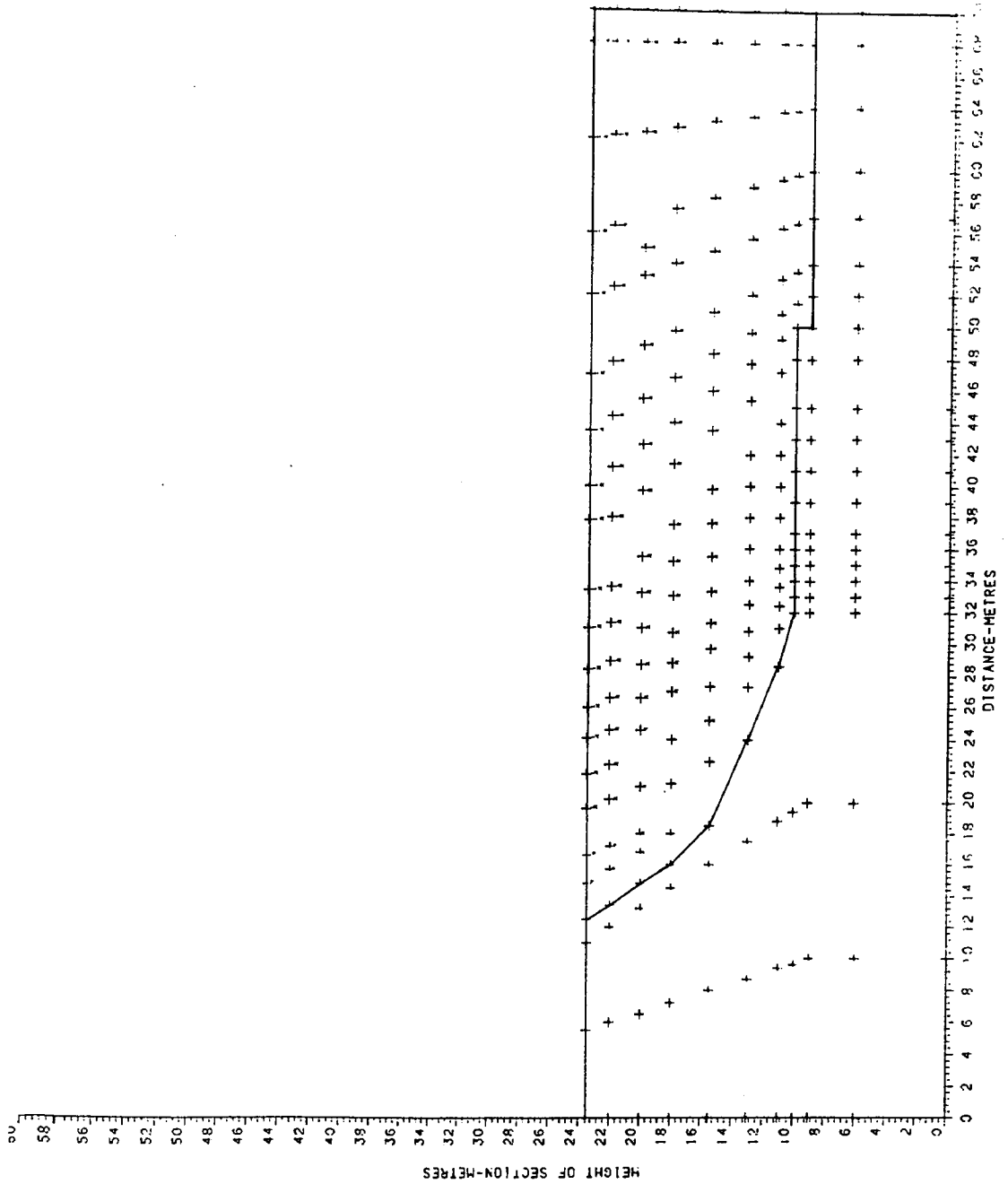

BUILD UP OF MODEL H1 (H106)

FIGURE 6.4.16.

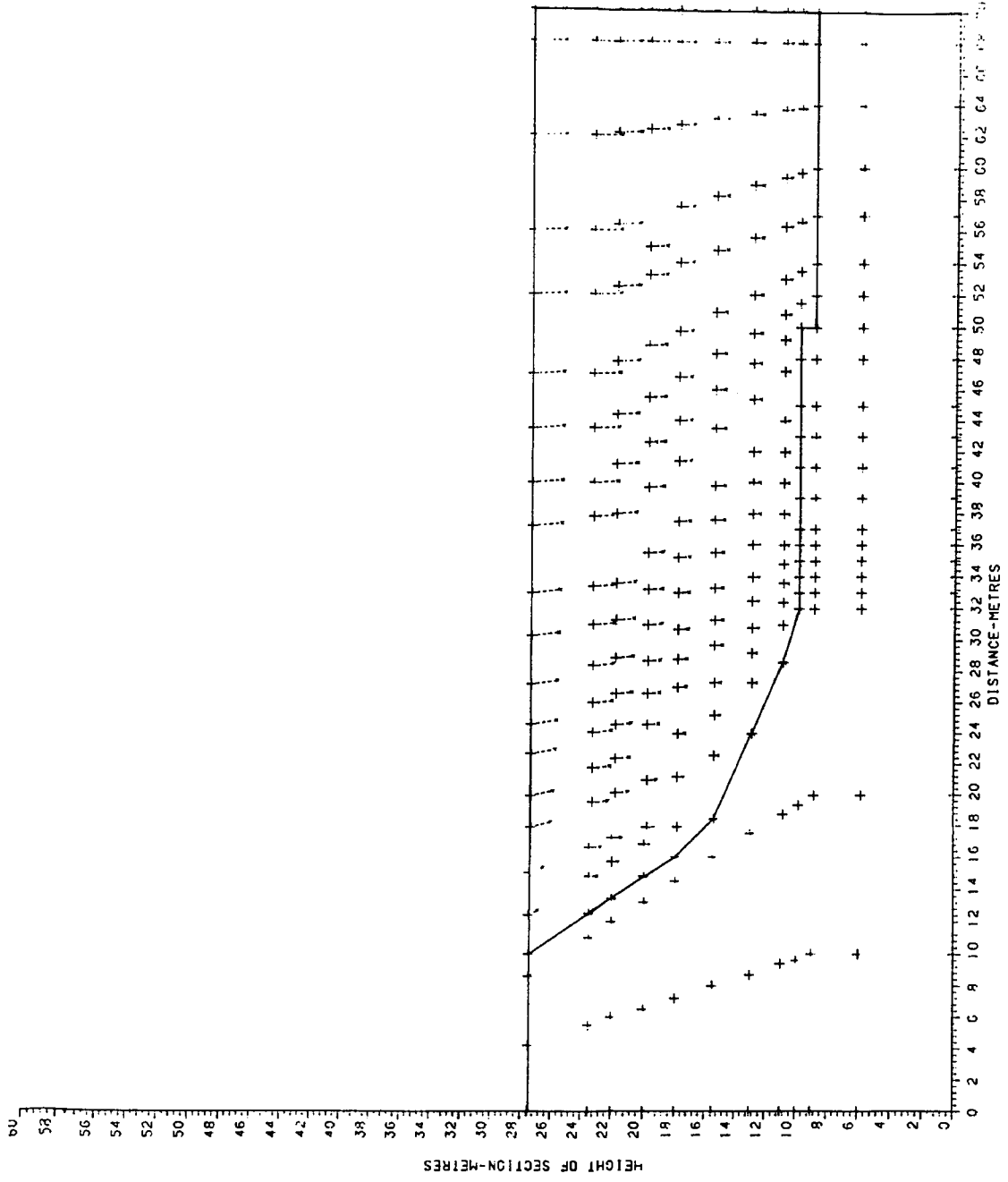

BUILD UP OF MODEL H1 (H107)

FIGURE 6-4-17.

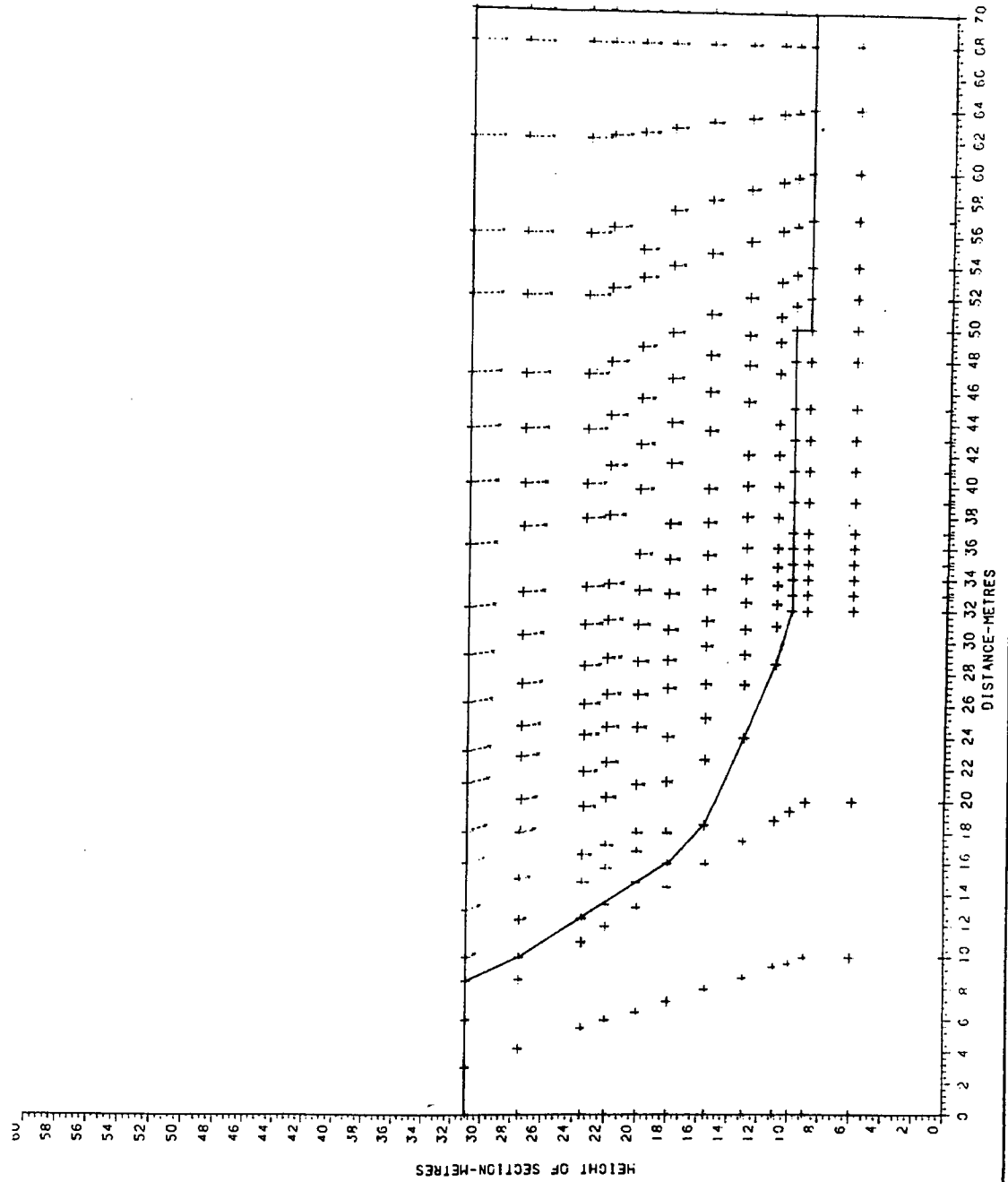

BUILD UP OF MODEL H1 (H108)

FIGURE 6-4-18.

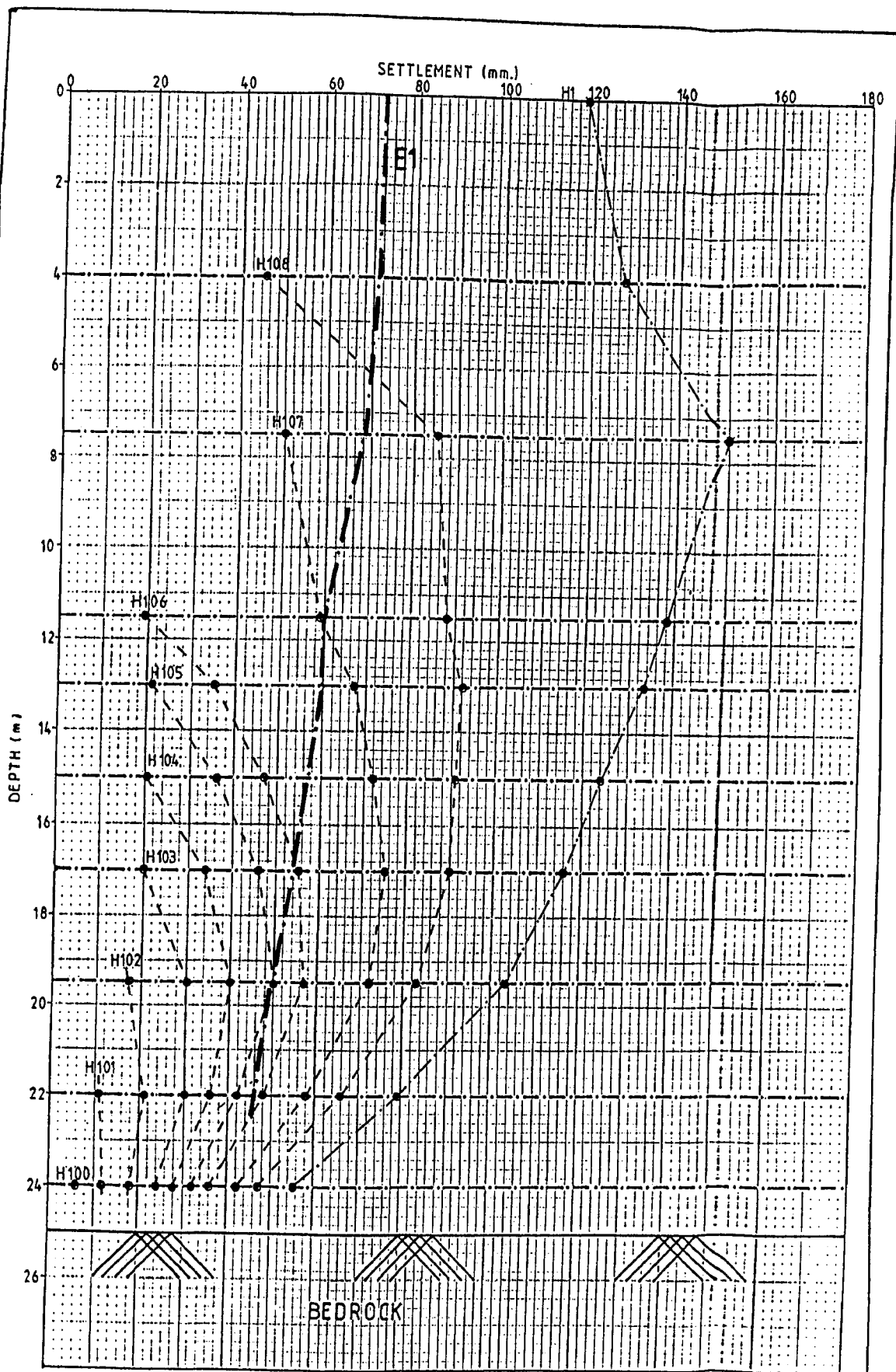

BUILD UP MODEL H1-PLOT OF CUMULATIVE SETTLEMENT WITH DEPTH.

FIGURE 6.4.19.



**7. CONCLUSIONS AND RECOMMENDATIONS**

**7.1 Introduction.**

**7.2 Settlement Prediction.**

**7.3 Field Controls and Monitoring.**

**7.4 Application of Settlement Predictions.**

**7.5 Topics for Further Research.**

## 7.1 INTRODUCTION

From the research detailed in the previous sections, a number of conclusions and recommendations may be derived, principally with respect to methods for predicting the settlement of backfill in controlled backfill sites. Also, with respect to methods of controlling, testing and monitoring such sites. A summary of these conclusions is presented below, together with recommendations for the uses to which the information may be put. Topics for further research which would be of value in this field are also given.

## 7.2 SETTLEMENT PREDICTION

The results of settlement monitoring clearly demonstrate that on restored opencast sites, where the backfill has been placed in a controlled manner, accurate predictions of fill settlement can be made. A linear relationship has been established when plotting 'creep' settlement (expressed as a percentage of fill height) against the logarithm of time. In addition, and very importantly, 'creep' settlement is effectively complete within 18 months after completion of restoration.

Hence, although the magnitude of settlement which occurs in a controlled backfill is similar to the average settlement of semi-controlled backfill (such as at Milking Bank) it is completed in a very much shorter time period. In isolated areas of semi-controlled sites the magnitude of fill settlement can be much greater, similar to that in uncontrolled backfill, hence the variation in settlement is also much greater than in a controlled site.

The gradient of the settlement v. log time relationship varies for different heights of fill, a decrease in the gradient occurs

with increasing fill height. This pattern is believed to be due to the difference in time taken to place varying heights of fill by the same, conventional, earth-moving plant, i.e. the deeper the fill, then the greater is the likelihood that the deeper fill layers will have undergone a substantial proportion of 'creep' settlement before restoration is completed and monitoring commences.

Where there is sufficient settlement data available, and the fill thicknesses are accurately recorded, detailed predictions of fill settlement can be made. At the Holly Bank and Hurst sites the magnitude of settlement (expressed as a percentage of fill height) is shown to vary between 0.19 and 0.33 percent for fill heights ranging between 10 and 60 metres, commencing one month after restoration.

Where it has been possible to record the settlement which occurs at various depths within the backfill, the magnitude of settlement has been shown to decrease with depth. It does not, however, appear to be in direct proportion to increasing overburden pressure. A marked increase in vertical compression does occur within the saturated zone, inferring that saturation of the fill causes additional settlement. However, unlike uncontrolled backfill sites where saturation causes sudden collapse settlement (e.g. Horsley, Charles et al., 1977) no sudden change in the settlement profile has been seen. From this it has been concluded that the rate of water uptake has been steady and the backfill is in a sufficiently dense packing that there is a minimum of voids from the outset and hence a maximum of inter-particle contacts.

Assuming one-dimensional consolidation, the above settlement observations can be used to determine the pattern of settlement

which may occur in the zone adjacent to a highwall or over a buried highwall. Although a very simple approach, the results obtained from such analysis have been shown to be sufficiently detailed for most practical purposes.

During the 'creep' settlement period appreciable differential settlement occurs adjacent to highwall features. The width of the zone within which differential settlement is of any significance, at the surface, is approximately equal to the horizontal distance between the top and bottom of the highwall. The magnitude of differential settlement is dictated by the highwall inclination, i.e. the steeper the highwall, the greater the magnitude of differential settlement but the narrower the zone width.

Where there is a sufficiently thick (10-15m) blanket of fill above a buried feature, such as an internal highwall, the differential settlement across the feature is negligible.

Computer modelling, using a simple two-dimensional linear elastic finite element analysis, has produced qualitatively similar surface settlement profiles in highwall zones, to those predicted by settlement monitoring.

Difficulties are, however, apparent in such analysis, principally because of the way in which the backfill column is constructed, i.e. in successive layers. Each layer of fill not only applies load to the underlying material due to its self-weight but it also adds stiffness to the structures as a whole.

In any single finite element model, the settlement calculated at the surface is that which is indicated to occur following the placement of the final layer of fill. No account can be made in

a single model for the settlement which occurs due to the placement of the deeper fill layers. In an attempt to overcome this problem a build-up layer-by-layer model was used, where the settlements were calculated by superposition to produce a total settlement profile for varying fill thicknesses, or at various levels within the fill.

By the use of calculated stiffness properties for the individual fill layers in single models, the pattern of settlement across highwall and buried highwall features compared favourably with observed settlement profiles, although the magnitude of settlement did not.

Until such time as settlement monitoring can commence from the moment that the fill layers are placed, a direct comparison cannot be made with a 'build up' model. The settlement measured in the fill column following the placement of the last backfill layer, will be a percentage of cumulative settlement plot produced by a 'build up' model, the percentage decreasing with depth.

### 7.3 FIELD CONTROLS AND MONITORING

#### 7.3.1 Field Controls on Backfilling

Where it is desirable to restore an opencast site in a controlled manner, it is appropriate to use specifications and control methods developed for conventional earthworks contracts, such as earth dams or highway embankments.

The nuclear moisture/density gauge has been demonstrated to be a useful tool for controlling the backfilling operations on a daily basis. Inaccuracies can, however,

arise with this apparatus, principally because of the carbonaceous content of some of the backfill causing abnormally high moisture readings. Conventional 'physical' tests, such as compaction, moisture content and sand replacement tests are normally maintained to check the nuclear gauge results.

The Moisture Condition Value (MCV) apparatus has not, to the writer's knowledge, been used in controlling an earthworks operation of this kind. Since this is a relatively speedy 'physical' test, where factors such as carbonaceous content would have no influence, it may offer a more accurate alternative to the nuclear gauge.

In addition to their speed the nuclear gauge and MCV tests hold the advantage over conventional tests in that they are inexpensive and are usually carried out by the Engineer. Because they are inexpensive a far greater number of tests can normally be allowed. Since the Engineer is directly involved in the tests he should have a greater understanding and control on the operations.

### 7.3.2 Monitoring and Testing

Although this study has shown that settlement of a controlled backfill can be predictable and the test results reproducible, the large number of variables involved at each site require that each must be treated individually and adequate monitoring and testing undertaken.

### 7.3.2.1 Monitoring

A large number of basic surface settlement monitoring stations, together with a few sophisticated stations, such as magnet extensometers and piezometers, offers a suitable combination for monitoring purposes. A balance between adequate data for the proposed site re-development and cost has to be reached.

Simple mild steel pins, driven into the ground over a grid pattern, provide accurate surface settlement information. Care is, however, required in interpretation once the magnitude of settlement is low, since such stations can be affected by shrinkage and swelling in the ground caused by seasonal (or other) variations in moisture content. Caution is also required when site development is underway during the monitoring period, the passage of traffic close to (or over) stations will cause errors.

Where it is desirable to obtain settlement information at various depths in the backfill, magnet extensometers have provided adequate data. Such installations are, however, limited to recording that settlement which occurs following completion of backfilling in that area.

Although it would be desirable to monitor settlement from the onset, this is prone to installation difficulties.

For this, systems such as pneumatic settlement gauges would have to be considered which require remote recording stations, a balance well, and trenches dug for the small bore tubing between the settlement gauges and the monitoring station.

At any site it is of benefit to monitor the recovery of

the groundwater; knowledge of the groundwater conditions prior to opencast mining is desirable in this context. It is often useful to locate standpipes/piezometers adjacent to settlement monitoring stations.

#### 7.3.2.2 Testing

Three principal test methods have been adopted when examining the engineering characteristics of the backfill, namely, plate loading, standard penetration and static cone penetrometer testing.

##### Plate Loading Tests

Plate loading tests have been used for estimating the allowable bearing pressure for the backfill. It is clear, however that erroneous results can occur because of the coarse particle fraction of the material.

Employing a plate size of 600mm diameter, although a reasonable sized plate for testing most materials, will principally be testing the matrix of the backfill. In order to test the backfill mass a considerably larger test area would need to be adopted, for example, using a cast in-situ base or by surcharging the ground.

Despite the limitations of relatively conventional plate sizes, the results still provide useful information which can be used for design purposes.

##### Standard Penetration Tests

The results of the Standard Penetration Tests have been shown to provide a useful indication of the density of



the backfill. General trends can be identified if the results are carefully examined.

It has been shown that in a "fresh" controlled backfill (Hurst) the density of the material remains relatively uniform with depth. However, in older backfill (Milking Bank), despite a less stringent compaction specification, the N-value is similar at the surface, but there is marked increase with depth. The implied increase in density with depth would be expected as a result of the long term consolidation of the fill under overburden pressure, a process incomplete in the "fresh" backfill.

#### Static Cone Penetrometer Testing

Static cone testing has the advantage over SPT's in being a continuous test; from it, an indication of the soil type and density can be derived. Difficulties can arise in the interpretation of the results because of the lack in consistency caused by the varied composition of the backfill. It could be suggested, however, that consideration of the mean values obtained in such a test could give a reasonable indication of the characteristics of the fill mass.

#### 7.4 APPLICATION OF SETTLEMENT PREDICTION TO SITE DEVELOPMENT

Use can be made of predictive settlement analysis to determine when development may proceed on restored opencast sites. Where the backfill is placed in a controlled manner it can be shown that this analysis can be very accurate and any time delay (before development) is minimal.

Since differential settlement on controlled backfill sites is

minimal within the main backfill benches, development can often proceed in these areas once restoration is complete. Providing adequate survey information is available, zones which may undergo unacceptable amounts of differential settlement can be specified.

Except where buildings would be underlain by significant variations in fill thickness at shallow depth, and hence where differential settlement could result due to the applied foundation pressures, many of these zones can be developed after a suitable time interval. For this, it is necessary to be aware of the size of the structures, their likely bearing pressures and the angular distortion which can be tolerated by them.

At the Hurst site, knowledge of the settlement pattern was used in planning the development of the opencast operations themselves. For example, the shape and location of the main (west) highwall was adjusted so that it would be located alongside the proposed main (central) distributor road. Subsequent development areas will therefore be entirely outside the opencast area or in the main body of the excavation. There will be no need to incorporate precautions, or adjust building positions for boundary situations, except possibly between backfill benches. The zone adjacent to, and over, the highwall, will be used for visual barriers and a flexible road and services. In addition, by adopting an opencast operation whereby excavation and backfilling commenced from south to north, development can proceed virtually straight away at the main (southern) entrance to the site.

In the knowledge that restored opencast mining sites can be redeveloped within a relatively short period the method has been

used to restore derelict land. Each of the sites considered in this research were sites derelict following an earlier history of shallow underground mining. The alternative to opencast mining restoration would have been extensive, and expensive, drilling and pressure grouting of mine workings, shafts and adits. With varying degrees of success, revenue gained in selling the coal and the resale of development-grade land has been used to off-set the costs of opencast mining, controlled restoration and monitoring. At the Hurst site, the result of detailed planning and a high standard of workmanship in a very confined working area has been to produce land available for redevelopment, free of any major layout constraints. This has been achieved at a profit to the contractor/developer and with benefit to the area.

Had the above sites been restored for development by the conventional technique of pressure grouting, a valuable energy resource would have been lost, instead this has been put to good use.

#### 7.5 TOPICS FOR FURTHER RESEARCH

In the controlled backfill sites considered in this research, it is evident that variations in the settlement results can or do result from different methods of compaction, the speed of restoration, material variations and groundwater conditions. In order to more fully appreciate the influence of these factors further settlement monitoring results need to be considered.

Where the geometry of a site, and the backfilling program would allow it, it would be of benefit to obtain settlement data at depth in backfill from the onset of settlement. This could be

used for a more detailed study of the changing stiffness properties of the backfill with increasing depth of burial using a finite element analysis. In view of the difficulties in obtaining information of this type in opencast sites, alternative (but similar) layered backfill areas could be considered, for example, road or dam embankments which are composed of opencast waste or colliery spoil.

LIST OF REFERENCES

- Arrowsmith, E.J. (1979): Roadwork Fills - a materials engineer's viewpoint. Clay Fills. Institution of Civil Engineers. London, pp. 25 - 36.
- British Standards Institution (1975): Methods of testing for soils for Civil Engineering purposes. BS 1377.
- British Standards Institution (1981): Code of practice for Site Investigations. BS 5930.
- Charles, J.A., Naismith, W.A. and Burford, D. (1977): Settlement of backfill at Horsley restored opencast coal mining site. Conf. on Large Ground Movements and Structures, Cardiff.
- Charles, J.A., Earle, E.W. and Burford, D. (1978): Treatment and subsequent performance of cohesive fill left by opencast ironstone mining at Snatchill experimental housing site, Corby. Clay Fills. Institution of Civil Engineers, London.
- Charles, J.A. and Burland, J.B. (1982): Geotechnical considerations in the design of foundations for buildings in deep deposits of waste materials. The Structural Engineer, Vol. 60A, No. 1, pp. 8 - 14.

- Charles, J.A. (1984): Some geotechnical problems associated with the use of coal mining wastes as fill materials. Symp. on the Reclamation Treatment and Utilisation of Coal Mining Wastes. N.C.B. Minestone Executive, Durham, Paper No. 50.
- Desai, C.S. and Abel, J.S. (1972): Introduction to the Finite Element Method. A Numerical Method for Engineering Analysis. Van Nostrand Reinhold.
- Department of Transport (1976): Specification for Road and Bridgeworks. H.M.S.O.
- Gilbert, J.A. and Knipe, C. (1979): Residential development on reclaimed opencast mining sites. The Engineering Behaviour of Industrial and Urban Fill. Proc. Symp. of the Uni. of Birmingham, pp. E67 - E80.
- Hughes, D. (1986): Geotechnical Engineering in Opencast Coal Mining. British Geologist. Institution of Geologists, Vol. 12, No. 2, pp. 61 - 63.
- Kennard, M.F., Knill, J.L. and Vaughan, P.R. (1967): The Geotechnical properties and behaviour of Carboniferous Shale at Balderhead Dam. Q. Jl. Engng, Geol., Vol. 1 pp. 3 - 24.

- Kilkenny, W.M. (1968): A study of the settlement of restored opencast coal sites and their suitability for building development. Uni. of Newcastle Upon Tyne. Dept. of Civil Eng., Bulletin No. 38.
- Knipe, C. (1979): Comparison of settlement rates on back filled opencast mining sites. The Engineering Behaviour of Industrial and Urban Fill, Proc. Symp. at the Uni. of Birmingham, pp. E81 - E98.
- Leigh, W.J.P. and Rainbow, K.R. (1979): Observations of the Settlement of Restored Backfill of Opencast Mine Sites. The Engineering Behaviour of Industrial and Urban Fill, Proc. Symp. at the Uni. of Birmingham, pp. E99 - E128.
- Meyerhof, G.G. (1951): Building on Fill. Structural Engineer, 1, pp. 46 - 57.
- Ministry of Transport (1963): Specification for Road and Bridgeworks. H.M.S.O.
- Parson, A.W. (1981): The assessment of soils and soft rocks for embankment construction. Q.Jl. Eng. Geol., London, Vol. 14, pp. 219 - 230.
- Penman, A.D.M. (1971): Rock Fill. Building Research Station, Current Paper No. 15.

Penman, A.D.M., Burland, J.B. and Charles, J.A. (1973): Observed and predicted deformations in a large embankment dam during construction. Jnl. S.M. and F. Div., A.S.C.E., Vol. 99, No. SM2, pp. 139 - 163.

Penman, A.D.M. and Charles, J.A. (1975): The quality and suitability of rockfill used in dam construction. Building Research Station, Current Paper No. 87.

Penman, A.D.M. and Godwin, E.W. (1975): Settlement of Experimental Houses on Land Left by Opencast Mining at Corby. Conf. on Settlement of Structures, Cambridge, pp. 53 - 61.

Road Research Laboratory (1952): Soil Mechanics for Road Engineers. H.M.S.O.

Schmertman, J.H. (1970): Static Cone to compute static settlement over sand. Proc. A.S.C.C., J. Soil Mech. Found. Div., No. 3.

Sowers, G.F., Williams, R.C. and Wallace, T.S., (1965): Compressibility of broken rock and the settlement of rockfills. Proc. 6th Int. Conf. on S.M.E.F.E., pp. 561 - 565.



- Spears, D.A., Taylor, R.K. and Till, R. (1971): A mineralogical investigation of a spoil heap at Yorkshire Main Colliery, Q. Jl. Engng. Geol., Vol. 3, pp. 239 - 252.
- Turner, M.D. (1979): Lithology, behaviour and properties of coarse unburnt colliery spoils in relation to their use as fill. The Engineering Behaviour of Industrial and Urban Fill. Proc. Symp. at the Uni. of Birmingham. pp. B35 - B48.
- University of Aston, Computer Centre (1980): 1900 Gino Graph Plotter Routines. Uni. of Aston.
- Westenberger, F. (1967): Measurement of settlements and displacements in soil Embankments. Comission Internationale Des Grands Barrages, Istanbul, pp. 653 - 682.
- Wilun, Z. and Starzewski, K. (1975): Soil Mechanics in Foundation Engineering, Vol. 2, 2nd Ed. surrey Uni. Press.

APPENDIX I

PLATE LOAD TEST RESULTS



224  
PLATE LOAD TEST RESULTS

TEST No 2

LOCATION: HURST OPENCAST SITE

DEPTH : GROUND LEVEL

DATE : 11th FEBRUARY, 1984

PLATE SIZE: 600mm diam.

WEATHER : DRY & WILD

TIME		LOAD kN	PRESSURE kN/m <sup>2</sup>	SETTLEMENT (0.0001")				AVERAGE SETTLEMENT (mm)	REMARKS
O'clock	ELAPSE (mins)			I	II	III	IV		
10.47	0	21.2	75.0	-	-	-	-		
	1	"	"	774	166	268	-	1.020	
	2	"	"	122	135	62	-	0.270	
	4	"	"	9	39	50	-	0.083	
	8	"	"	47	125	92	-	0.223	
	12	"	"	224	75	56	-	0.249	
	16	"	"	28	26	24	-	0.066	
	25	"	"	40	35	33	-	0.091	
	36	"	"	50	72	53	-	0.148	
	48	"	"	20	24	26	-	0.060	
	60	"	"	34	38	18	-	0.076	
12.08	81	"	"	8	9	1	-	0.015	
12.12	0	39.4	140.0	-	-	-	-		
	1	"	"	598	891	697	-	1.845	
	2	"	"	150	130	80	-	0.304	
	4	"	"	120	-	90	-	0.266	DIAL GANBE II
	8	"	"	80	-	70	-	0.190	SANDED.
	12	"	"	75	-	59	-	0.170	
	16	"	"	35	-	26	-	0.077	
	25	"	"	50	-	49	-	0.125	
	36	"	"	40	-	36	-	0.096	
	48	"	"	40	-	37	-	0.097	
	60	"	"	21	-	23	-	0.056	
	81	"	"	21	-	13	-	0.043	
14.15	123	"	"	28	-	47	-	0.095	



526  
PLATE LOAD TEST RESULTS

TEST No 3

LOCATION: HURST OPENCAST SITE

DEPTH : GROUND LEVEL . . .

DATE : 17th JUNE, 1984 . . . . .

PLATE SIZE: 600mm diam.

WEATHER : DAY & SUNNY . . .

TIME		LOAD kN	PRESSURE kN/m <sup>2</sup>	SETTLEMENT (0.0001")				AVERAGE SETTLEMENT (mm)	REMARKS
0'clock	ELAPSE (mins)			I	II	III	IV		
09:56	0	39.4	140.0	-	-	-	-	-	
	1	"	"	644	358	-	-	1.270	
	3	"	"	90	113	-	-	0.260	
	5	"	"	37	37	-	-	0.090	
	8	"	"	26	29	-	-	0.070	
	12	"	"	21	20	-	-	0.052	
	16	"	"	25	21	-	-	0.058	
	25	"	"	41	32	-	-	0.093	
	36	"	"	23	13	-	-	0.046	
	48	"	"	25	18	-	-	0.055	
	60	"	"	21	13	-	-	0.043	
	80	"	"	20	7	-	-	0.034	
11:36	100	"	"	21	17	-	-	0.048	
11:40	0	59.8	211.0	-	-	-	-	-	
	1	"	"	66	103	-	-	0.215	
	2	"	"	56	46	-	-	0.130	
	4	"	"	76	76	-	-	0.193	
	8	"	"	39	52	-	-	0.116	
	12	"	"	29	14	-	-	0.055	
	19	"	"	42	34	-	-	0.096	
	25	"	"	22	18	-	-	0.051	
	36	"	"	36	34	-	-	0.089	
	48	"	"	26	22	-	-	0.061	
12:40	60	"	"	23	19	-	-	0.053	
						-	-		



# PLATE LOAD TEST RESULTS

TEST No 3  
(CONTINUED)

LOCATION: HURST OPENCAST SITE

DEPTH : GROUND LEVEL

DATE : 17th JUNE, 198

PLATE SIZE: 600mm diam

WEATHER : DRY & SUNNY

TIME		LOAD kN	PRESSURE kN/m <sup>2</sup>	SETTLEMENT (0.0001")				AVERAGE SETTLEMENT (mm)	REMARKS
O'clock	ELAPSE (mins)			I	II	III	IV		
14.44	0	119.6	422.0	-	-	-	-		
	1	"	"	125	172	-	-	0.377	
	2	"	"	8	26	-	-	0.043	
	4	"	"	14	54	-	-	0.086	
	8	"	"	20	10	-	-	0.038	
	12	"	"	-	8	-	-	0.020	DIAL GANGE I AT
	16	"	"	-	12	-	-	0.030	END OF TRAVEL
	25	"	"	-	4	-	-	0.010	
15.20	36	"	"	-	0	-	-	0	
15.24	0	139.5	493.0	-	-	-	-		
	1	"	"	7	15	-	-	0.028	
	2	"	"	24	13	-	-	0.047	
	4	"	"	20	15	-	-	0.044	
	8	"	"	14	20	-	-	0.043	
	12	"	"	31	49	-	-	0.100	
	16	"	"	1	2	-	-	0.004	
	25	"	"	7	1	-	-	0.010	
	36	"	"	39	37	-	-	0.091	
16.12	48	"	"	8	10	-	-	0.023	
16.13	0	159.4	563.0	-	-	-	-		
	1	"	"	17	0	-	-	0.021	
	2	"	"	8	8	-	-	0.020	
	4	"	"	2	4	-	-	0.008	
	8	"	"	16	0	-	-	0.020	
16.25	12	"	"	0	4	-	-	0.005	





# PLATE LOAD TEST RESULTS

TEST No 4

LOCATION: HURST OPENCAST SITE

DEPTH : GROUND LEVEL

DATE : 12<sup>th</sup> AUGUST 1984

PLATE SIZE: 600mm diam.

WEATHER : DRY & SUNNY.

TIME		LOAD kN	PRESSURE kN/m <sup>2</sup>	SETTLEMENT (0.0001")				AVERAGE SETTLEMENT (mm)	REMARKS
O'clock	ELAPSE (mins)			I	II	III	IV		
10:06	0	21.2	75.0	-	-	-	-	-	
	1	"	"	249	214	-	-	0.590	
	2	"	"	41	40	-	-	0.100	
	4	"	"	36	28	-	-	0.080	
	8	"	"	43	33	-	-	0.100	
	12	"	"	26	29	-	-	0.070	
	16	"	"	9	5	-	-	0.020	
	25	"	"	6	7	-	-	0.015	
	36	"	"	6	7	-	-	0.015	
	48	"	"	14	14	-	-	0.040	
	60	"	"	20	14	-	-	0.045	
11:07	0	39.4	140.0	-	-	-	-	-	
	1	"	"	320	278	-	-	0.760	
	2	"	"	23	19	-	-	0.050	
	4	"	"	24	19	-	-	0.050	
	8	"	"	23	21	-	-	0.050	
	12	"	"	10	10	-	-	0.025	
	16	"	"	12	12	-	-	0.025	
	25	"	"	10	12	-	-	0.025	
	36	"	"	9	13	-	-	0.025	
	48	"	"	9	10	-	-	0.020	
12:07	60	"	"	14	11	-	-	0.025	
12:08	0	59.8	211.0	-	-	-	-	-	
	1	"	"	334	325	-	-	0.840	
12:10	2	"	"	12	10	-	-	0.030	

221  
PLATE LOAD TEST RESULTS

TEST No 4  
(CONTINUED)

LOCATION: HURST OPENCAST SITE

DEPTH : GROUND LEVEL

DATE : 12th AUGUST, 1984

PLATE SIZE: 600mm diam.

WEATHER : DRY & SUNNY

TIME		LOAD kN	PRESSURE kN/m <sup>2</sup>	SETTLEMENT (0.0001")				AVERAGE SETTLEMENT (mm)	REMARKS
O'clock	ELAPSE (mins)			I	II	III	IV		
12.12	4	59.8	211.0	29	16	-	-	0.050	
	8	"	"	24	29	-	-	0.060	
	12	"	"	25	22	-	-	0.055	
	16	"	"	22	22	-	-	0.050	
	25	"	"	8	5	-	-	0.015	
	36	"	"	6	2	-	-	0.010	
	48	"	"	8	4	-	-	0.015	
13.08	60	"	"	2	1	-	-	0	
13.09	0	79.2	280.0	-	-	-	-	-	
	1	"	"	1	74	-	-	0.095	
	2	"	"	10	2	-	-	0.015	
	4	"	"	0	0	-	-	0	
13.17	8	"	"	0	0	-	-	0	
	0	39.4	140.0	-	-	-	-	-	
	1	"	"	0	0	-	-	0	
	2	"	"	0	0	-	-	0	
	4	"	"	0	0	-	-	0	
	8	"	"	0	0	-	-	0	
13.29	12	"	"	0	0	-	-	0	
	0	ZERO	ZERO	-	-	-	-	-	
	1	"	"	+342	+333	-	-	+0.86	
	2	"	"	+35	+48	-	-	+0.105	
	4	"	"	+20	+32	-	-	+0.065	
	8	"	"	+22	+34	-	-	+0.070	
13.41	12	"	"	+35	+35	-	-	+0.090	





254  
PLATE LOAD TEST RESULTS

TEST No 5  
(CONTINUED)

LOCATION: HURST OPENCAST SITE

DEPTH : . GROUND LEVEL . .

DATE : . 27<sup>th</sup> APRIL, 1985 . . . . .

PLATE SIZE: 600mm diam. . .

WEATHER : COLD - OCC. RAIN . .

TIME		LOAD kN	PRESSURE kN/m <sup>2</sup>	SETTLEMENT (0.0001")				AVERAGE SETTLEMENT (mm)	REMARKS
0'clock	ELAPSE (mins)			I	II	III	IV		
13.45	0	79.2	280	-	-	-	-	-	
	1	"	"	1	5	4	-	0.008	
	2	"	"	1	2	1	-	0.004	
	4	"	"	0	1	1	-	0.001	
	8	"	"	1	0	9	-	0.004	
	12	"	"	1	1	1	-	0.002	
14.00	15	"	"	2	1	1	-	0.003	
	0	99.6	352.0	-	-	-	-	-	
	1	"	"	3	0	1	-	0.003	
	2	"	"	3	1	1	-	0.004	
	4	"	"	3	0	0	-	0.002	
	8	"	"	0	0	2	-	0.001	
	12	"	"	1	0	0	-	0.001	
14.15	15	"	"	5	0	0	-	0.004	
	0	119.6	422.0	-	-	-	-	-	
	1	"	"	8	2	2	-	0.01	
	2	"	"	4	0	1	-	0.004	
	4	"	"	32	0	-	-	0.027	
	8	"	"	25	3	1	-	0.025	
	12	"	"	5	0	0	-	0.004	
14.30	15	"	"	5	1	0	-	0.005	
	0	139.5	493.0	-	-	-	-	-	
	1	"	"	19	5	0	-	0.02	
	2	"	"	8	3	0	-	0.009	
14.34	4	"	"	2	18	1	-	0.018	







221  
PLATE LOAD TEST RESULTS

TEST No 6

LOCATION: HURST OPENCAST SITE

DEPTH : . 130mm. . . . .

DATE : . 18<sup>th</sup> MAY, 1985 . . . . .

PLATE SIZE: . 600mm diam. . . . .

WEATHER : DRY & SUNNY . . . . .

TIME		LOAD kN	PRESSURE kN/m <sup>2</sup>	SETTLEMENT (0.0001")				AVERAGE SETTLEMENT (mm)	REMARKS
0'clock	ELAPSE (mins)			I	II	III	IV		
12.11	0	21.2	75.0	-	-	-	-		
	1	"	"	2	3	4	-	0.005	
	2	"	"	0	2	0	-	0.002	
	4	"	"	0	6	5	-	0.014	
	8	"	"	0	1	0	-	0.001	
	12	"	"	0	11	1	-	0.015	
12.26	15	"	"	0	1	0	-	0.001	
	0	39.4	140.0	-	-	-	-		
	1	"	"	0	115	76	-	0.243	
	2	"	"	0	36	27	-	0.080	
	4	"	"	0	4	5	-	0.011	
	8	"	"	0	12	3	-	0.019	
	12	"	"	0	10	7	-	0.022	
	16	"	"	0	8	6	-	0.018	
12.46	20	"	"	0	2	2	-	0.005	
	0	59.8	211.0	-	-	-	-		
	1	"	"	189	214	114	-	0.438	
	2	"	"	3	15	18	-	0.030	
	3	"	"	29	26	21	-	0.063	
	4	"	"	31	15	13	-	0.048	
	8	"	"	37	40	39	-	0.098	
	12	"	"	5	10	11	-	0.022	
	16	"	"	4	8	7	-	0.016	
	20	"	"	15	11	19	-	0.038	
13.11	25	"	"	8	7	2	-	0.014	

# PLATE LOAD TEST RESULTS

TEST No 6  
(CONTINUED)

LOCATION: HURST OPENCAST SITE

DEPTH : 130mm . . . . .

DATE : 18th MAY, 1985 . . . . .

PLATE SIZE: 600mm diam.

WEATHER : DRY & SUNNY . . . . .

TIME		LOAD kN	PRESSURE kN/m <sup>2</sup>	SETTLEMENT				AVERAGE SETTLEMENT (mm)	REMARKS
0'clock	ELAPSE (mins)			I	II	III	IV		
13-16	30	59.8	211.0	7	12	4	-	0.020	
	0	79.2	280.0	-	-	-	-	-	
	1	"	"	209	239	369	-	0.691	
	2	"	"	22	28	32	-	0.069	
	4	"	"	22	18	13	-	0.045	
	8	"	"	13	43	38	-	0.103	
	12	"	"	18	18	18	-	0.046	
	16	"	"	9	7	8	-	0.020	
	20	"	"	10	13	8	-	0.025	
	25	"	"	24	20	28	-	0.061	
	30	"	"	10	11	9	-	0.025	
	35	"	"	4	0	1	-	0.004	
13-56	40	"	"	3	0	1	-	0.003	
	0	99.6	352.0	-	-	-	-	-	
	1	"	"	160	211	233	-	0.511	
	2	"	"	14	20	24	-	0.049	
	4	"	"	37	39	49	-	0.106	
	8	"	"	50	53	50	-	0.129	
	12	"	"	5	5	6	-	0.013	
	16	"	"	25	20	30	-	0.063	
	20	"	"	17	21	26	-	0.054	
	25	"	"	4	6	10	-	0.017	
14-26	30	"	"	1	4	21	-	0.022	
14-29	0	119.6	422.0	-	-	-	-	-	
	1	"	"	2	87	2	-	0.221	

229  
PLATE LOAD TEST RESULTS

TEST No 6  
(CONTINUED)

LOCATION: HURST OPENCAST SITE

DEPTH : . 130mm . . . . .

DATE : . 18th MAY, 1985 . . . . .

PLATE SIZE: 600mm diam: .

WEATHER : DRY & SUNNY: . .

TIME		LOAD kN	PRESSURE kN/m <sup>2</sup>	SETTLEMENT				AVERAGE SETTLEMENT (mm)	REMARKS
0'clock	ELAPSE (mins)			I	II	III	IV		
14.31	2	119.6	422.0	0	12	1	-	0.030	
	4	"	"	8	33	1	-	0.084	
	8	"	"	3	17	2	-	0.043	
	12	"	"	1	1	0	-	0.002	
	16	"	"	2	19	6	-	0.048	
	20	"	"	1	14	3	-	0.0356	
	25	"	"	2	8	3	-	0.020	
	30	"	"	0	10	3	-	0.025	
15.02	0	139.5	493.0	-	-	-	-	-	
	1	"	"	2	95	92	-	0.237	
	2	"	"	1	32	24	-	0.071	
	4	"	"	1	30	33	-	0.080	
	8	"	"	0	26	23	-	0.062	
	12	"	"	4	0	0	-	0	
	16	"	"	0	15	15	-	0.038	
	20	"	"	0	6	2	-	0.010	
	25	"	"	0	10	11	-	0.027	
	30	"	"	0	16	17	-	0.042	
	35	"	"	0	6	11	-	0.022	
15.42	40	"	"	0	8	6	-	0.018	
	0	156.7	554.0	-	-	-	-	-	
	1	"	"	102	77	174	-	0.299	
	2	"	"	0	22	25	-	0.060	
	4	"	"	0	34	34	-	0.086	
	8	"	"	25	34	34	-	0.086	



PLATE LOAD TEST RESULTS

TEST No 7

LOCATION: HURST OPENCAST SITE

DEPTH : GROUND LEVEL . . .

DATE : 10th AUGUST, 1985 . . . . .

PLATE SIZE: 600mm diam. . . .

WEATHER : MAINLY DRY, OCCASIONAL SHOWERS.

TIME		LOAD kN	PRESSURE kN/m <sup>2</sup>	SETTLEMENT (0.01mm)				AVERAGE SETTLEMENT (mm)	REMARKS
0'clock	ELAPSE (mins)			I	II	III	IV		
12.25	0	21.2	75.0	-	-	-	-		
	1	"	"	-	46	43	1	0.30	DIAL GAUGE I
	2	"	"	-	4	6	2	0.04	SAMPLED.
	4	"	"	-	6	9	2	0.17	"
	8	"	"	-	6	10	2	0.06	"
	12	"	"	-	1	1	0	0.01	"
	16	"	"	-	2	4	1	0.02	"
12.45	20	"	"	-	2	1	0	0.01	"
	0	39.4	140.0	-	-	-	-	-	"
	1	"	"	-	62	81	-	0.715	DIAL GANGES I
	2	"	"	-	9	14	-	0.115	AND II SAMPLED.
	4	"	"	-	8	12	-	0.10	
	8	"	"	-	7	11	-	0.09	
	12	"	"	-	14	25	-	0.195	
	16	"	"	-	2	6	-	0.04	
13.05	20	"	"	-	2	0	-	0.01	
	0	59.8	211.0	-	-	-	-	-	
	1	"	"	45	107	133	44	0.822	
	2	"	"	18	19	20	17	0.185	
	4	"	"	12	15	17	12	0.140	
	8	"	"	11	14	16	11	0.130	
	12	"	"	13	15	17	15	0.150	
	16	"	"	6	7	8	6	0.070	
	20	"	"	8	8	10	7	0.080	
13.30	25	"	"	9	10	11	10	0.100	

242  
PLATE LOAD TEST RESULTS

TEST No 7  
(CONTINUED)

LOCATION: HURST OPENCAST SITE

DEPTH : GROUND LEVEL . . .

DATE : 10th AUGUST, 1985 . . . . .

PLATE SIZE: 600 mm diam :

WEATHER : MAINLY DRY, OCC. SHOWERS.

TIME		LOAD kN	PRESSURE kN/m <sup>2</sup>	SETTLEMENT (0.01mm)				AVERAGE SETTLEMENT (mm)	REMARKS
0'clock	ELAPSE (mins)			I	II	III	IV		
13.35	30	59.8	211.0	3	3	6	3	0.040	
13.39	0	79.2	280.0	-	-	-	-	-	
	1	"	"	97	118	130	70	1.037	
	2	"	"	9	14	21	16	0.150	
	4	"	"	10	10	13	8	0.100	
	8	"	"	9	13	16	5	0.107	
	12	"	"	12	13	14	32	0.177	
	16	"	"	5	6	7	5	0.060	
	20	"	"	10	11	12	10	0.100	
	25	"	"	5	5	6	4	0.050	
	30	"	"	5	6	7	5	0.060	
	35	"	"	1	3	2	1	0.020	
14.19	40	"	"	1	4	5	1	0.030	
14.20	0	99.6	352.0	-	-	-	-	-	
	1	"	"	76	53	129	60	0.800	
	2	"	"	20	91	19	20	0.375	
	4	"	"	33	32	34	30	0.320	
	8	"	"	21	22	20	20	0.207	
	12	"	"	12	14	14	8	0.120	
	16	"	"	24	23	22	24	0.230	DATUM FRAME
	20	"	"	5	4	6	5	0.050	NUDGED.
	25	"	"	9	8	7	9	0.080	
	30	"	"	9	10	10	12	0.100	
	35	"	"	6	8	9	15	0.095	
15.00	40	"	"	11	9	8	12	0.100	

242  
PLATE LOAD TEST RESULTS

TEST No 7  
(CONTINUED)

LOCATION: HURST OPENCAST SITE

DEPTH : GROUND LEVEL: .

DATE : 10<sup>th</sup> AUGUST, 1985 . . . . .

PLATE SIZE: 600mm diam. .

WEATHER : MAINLY DRY, OCC.  
SHOWERS.

TIME		LOAD kN	PRESSURE kN/m <sup>2</sup>	SETTLEMENT (0.01mm)				AVERAGE SETTLEMENT (mm)	REMARKS
O'clock	ELAPSE (mins)			I	II	III	IV		
15.05	45	99.6	352.0	12	10	9	9	0.100	
	50	"	"	10	11	11	14	0.115	
	55	"	"	6	4	4	5	0.050	
15.20	60	"	"	8	9	8	11	0.09	
	0	119.6	422.0	-	-	-	-	-	
	1	"	"	171	167	172	187	1.742	
	2	"	"	15	14	13	11	0.132	
	4	"	"	45	45	45	64	0.497	
	8	"	"	24	23	22	2	0.177	
	12	"	"	21	20	20	23	0.210	
	16	"	"	12	10	10	14	0.115	
	20	"	"	7	6	6	5	0.060	
	25	"	"	4	5	5	6	0.050	
	30	"	"	25	21	21	20	0.217	
	35	"	"	24	19	21	35	0.247	
	40	"	"	8	10	4	6	0.070	
	45	"	"	5	5	7	7	0.060	
	50	"	"	12	10	11	17	0.125	
	55	"	"	3	3	1	3	0.025	
16.20	60	"	"	7	4	8	4	0.057	
	0	139.5	493.0	-	-	-	-	-	
	1	"	"	86	83	86	97	0.880	
	2	"	"	15	14	13	21	0.157	
	4	"	"	9	9	10	9	0.090	
14.28	8	"	"	11	10	8	2	0.077	





245  
PLATE LOAD TEST RESULTS

TEST No 8

LOCATION: HURST OPENCAST SITE

DEPTH : . . . GROUND LEVEL

DATE : . . . 1st SEPTEMBER, 1984 . . .

PLATE SIZE: 600mm diam.

WEATHER : COLD & DRY . . .

TIME		LOAD kN	PRESSURE kN/m <sup>2</sup>	SETTLEMENT (0.0001")				AVERAGE SETTLEMENT (mm)	REMARKS
O'clock	ELAPSE (mins)			I	II	III	IV		
10.40	0	21.2	75.0	-	-	-	-		
	1	"	"	0	0	0	-	0	DELAY IN START
	2	"	"	0	0	0	-	0	DUE TO GRIT
	4	"	"	0	0	0	-	0	IN VALVE.
	8	"	"	0	0	0	-	0	
	12	"	"	0	0	0	-	0	
	16	"	"	0	0	0	-	0	
	20	"	"	0	0	0	-	0	
	25	"	"	0	0	0	-	0	
11.10	30	"	"	0	0	0	-	0	
	0	39.4	140.0	-	-	-	-	-	DIAL GANGE III
	1	"	"	13	25	-	-	0.048	SATURD.
	2	"	"	1	5	-	-	0.008	
	4	"	"	7	8	-	-	0.019	
	8	"	"	39	19	-	-	0.074	
	12	"	"	4	2	-	-	0.008	
	16	"	"	0	0	-	-	0	
	20	"	"	2	0	-	-	0.002	
	25	"	"	1	0	-	-	0.001	
11.40	30	"	"	1	0	-	-	0.001	
11.41	0	59.8	211.0	-	-	-	-	-	
	1	"	"	3	22	-	-	0.032	
	2	"	"	4	3	-	-	0.009	
	4	"	"	3	20	-	-	0.029	
11.49	8	"	"	5	1	-	-	0.008	

346  
PLATE LOAD TEST RESULTS

TEST No 8  
(CONTINUED)

LOCATION: HURST OPENCAST SITE

DEPTH : GROUND LEVEL . . .

DATE : 1st SEPTEMBER, 1984 . . . . .

PLATE SIZE : 600mm diam . . .

WEATHER : COLD & DRY . . .

TIME		LOAD kN	PRESSURE kN/m <sup>2</sup>	SETTLEMENT (0.001")				AVERAGE SETTLEMENT (mm)	REMARKS
O'clock	ELAPSE (mins)			I	II	III	IV		
11.53	12	59.8	211.0	12	4	-	-	0.020	DIAL GANGE III
	16	"	"	10	5	-	-	0.019	SATIMED.
	20	"	"	3	3	-	-	0.008	
	25	"	"	2	1	-	-	0.004	
12.11	30	"	"	1	0	-	-	0.001	
	0	79.2	280.0	-	-	-	-	-	
	1	"	"	52	7	-	-	0.075	
	2	"	"	41	34	-	-	0.095	
	4	"	"	10	12	-	-	0.028	
	8	"	"	25	17	-	-	0.053	
	12	"	"	4	6	-	-	0.013	
	16	"	"	8	1	-	-	0.011	
	20	"	"	1	2	-	-	0.004	
	25	"	"	10	2	-	-	0.015	
12.41	30	"	"	3	2	-	-	0.006	
12.43	0	99.6	352.0	-	-	-	-	-	
	1	"	"	1	68	2	-	0.060	
	2	"	"	1	12	2	-	0.013	
	4	"	"	1	11	1	-	0.011	
	8	"	"	4	1	0	-	0.004	
	12	"	"	10	11	4	-	0.021	
	16	"	"	10	8	3	-	0.018	
	20	"	"	14	7	3	-	0.020	
	25	"	"	11	3	5	-	0.016	
13.13	30	"	"	5	0	2	-	0.006	



240  
PLATE LOAD TEST RESULTS

TEST No 9

LOCATION: HURST OPENCAST SITE

DEPTH : GROUND LEVEL . .

DATE : . . 21<sup>st</sup> SEPTEMBER, 1985 . . .

PLATE SIZE: 600mm diam. . .

WEATHER : DRY . . . . .

TIME		LOAD kN	PRESSURE kN/m <sup>2</sup>	SETTLEMENT (0.0001")				AVERAGE SETTLEMENT (mm)	REMARKS
O'clock	ELAPSE (mins)			I	II	III	IV		
12:07	0	21.2	75.0	-	-	-	-		
	1	"	"	42	280	2	-	0.274	
	2	"	"	2	18	27	-	0.040	
	4	"	"	70	44	47	-	0.136	
	8	"	"	50	28	48	-	0.107	
	12	"	"	1	0	0	-	0	
	16	"	"	3	1	2	-	0.005	
	20	"	"	5	21	3	-	0.025	
	25	"	"	1	4	0	-	0.004	
12:37	30	"	"	0	3	3	-	0.005	
	0	39.4	140.0	-	-	-	-		
	1	"	"	201	321	288	-	0.686	
	2	"	"	19	0	25	-	0.037	
	4	"	"	30	61	43	-	0.114	
	8	"	"	17	24	26	-	0.057	
	12	"	"	3	5	23	-	0.026	
	16	"	"	9	0	8	-	0.014	
	20	"	"	30	50	26	-	0.090	
	25	"	"	6	1	4	-	0.009	
13:07	30	"	"	7	0	15	-	0.019	
	0	59.8	211.0	-	-	-	-		
	1	"	"	264	428	385	-	0.912	
	2	"	"	26	24	35	-	0.072	
	4	"	"	13	27	22	-	0.052	
13:15	8	"	"	27	47	51	-	0.106	

VIBRATING ROLLER  
PASSED WITHIN  
6 METRES.

# PLATE LOAD TEST RESULTS

TEST No 9  
(CONTINUED).

LOCATION: HURST OPENCAST SITE

DEPTH : GROUND LEVEL . . .

DATE : 21st SEPTEMBER, 1985 . . . . .

PLATE SIZE: 600mm diam. . . . .

WEATHER : DRY . . . . .

TIME		LOAD kN	PRESSURE kN/m <sup>2</sup>	SETTLEMENT (0.0001")				AVERAGE SETTLEMENT (mm)	REMARKS
0'clock	ELAPSE (mins)			I	II	III	IV		
13.19	12	59.8	211.0	19	6	39	-	0.054	
	16	"	"	0	38	25	-	0.053	
	20	"	"	0	16	11	-	0.023	
	25	"	"	0	5	7	-	0.010	
13.37	30	"	"	0	8	11	-	0.016	
	0	79.2	280.0	-	-	-	-	-	
	1	"	"	297	430	427	-	0.977	
	2	"	"	22	23	26	-	0.060	
	4	"	"	28	6	33	-	0.057	
	8	"	"	51	90	93	-	0.198	
	12	"	"	96	70	-	-	0.210	
	16	"	"	70	89	108	-	0.226	
	20	"	"	30	15	38	-	0.070	
	25	"	"	15	13	20	-	0.041	
	30	"	"	15	11	30	-	0.073	
	35	"	"	32	12	21	-	0.055	
	40	"	"	8	13	18	-	0.033	
	45	"	"	0	2	2	-	0.003	
14.27	50	"	"	0	0	0	-	0	
	0	99.6	352.0	-	-	-	-	-	
	1	"	"	0	12	0	-	0.010	
	2	"	"	48	0	1	-	0.040	
	4	"	"	4	3	3	-	0.008	
	8	"	"	3	3	0	-	0.005	
14.39	12	"	"	2	1	0	-	0.002	



221  
PLATE LOAD TEST RESULTS

TEST No 10

LOCATION: HURST OPENCAST SITE

DEPTH : GROUND LEVEL

DATE : 19th OCTOBER, 1985

PLATE SIZE: 600mm diam:

WEATHER : DRY:

TIME		LOAD kN	PRESSURE kN/m <sup>2</sup>	SETTLEMENT (0.01mm)				AVERAGE SETTLEMENT (mm)	REMARKS
0'clock	ELAPSE (mins)			I	II	III	IV		
12.25	0	21.2	75.0	-	-	-	-	-	
	1/2	"	"	88	132	85	-	1.02	
	1	"	"	0	0	0	-	0	
	2	"	"	7	12	13	-	0.107	
	4	"	"	4	6	5	-	0.050	
	8	"	"	5	5	4	-	0.047	
	12	"	"	6	3	6	-	0.050	
	16	"	"	1	0	1	-	0.007	
12.45	20	"	"	4	0	3	-	0.023	
	0	39.4	140.0	-	-	-	-	-	
	1/2	"	"	139	183	146	-	1.560	
	1	"	"	15	11	12	-	0.127	
	2	"	"	4	16	15	-	0.117	
	4	"	"	7	4	4	-	0.050	
	8	"	"	10	5	6	-	0.070	
	12	"	"	6	2	3	-	0.037	
	16	"	"	4	3	2	-	0.030	
	20	"	"	8	2	7	-	0.057	
	25	"	"	2	1	2	-	0.017	
13.15	30	"	"	3	0	5	-	0.027	
	0	59.8	211.0	-	-	-	-	-	
	1	"	"	291	254	250	-	2.650	
	2	"	"	-	7	6	-	0.065	DIAL GANGE I
	4	"	"	-	12	3	-	0.075	SAMPLED.
13.23	8	"	"	-	8	5	-	0.065	

352  
PLATE LOAD TEST RESULTS

TEST No 10  
(CONTINUED)

LOCATION: HURST OPENCAST SITE

DEPTH : GROUND LEVEL

DATE : 19th OCTOBER, 1985

PLATE SIZE: 600mm diam.

WEATHER : DRY

TIME		LOAD kN	PRESSURE kN/m <sup>2</sup>	SETTLEMENT (0.01mm)				AVERAGE SETTLEMENT (mm)	REMARKS
O'clock	ELAPSE (mins)			I	II	III	IV		
13-27	12	59.8	211.0	-	2	6	-	0.04	
	16	"	"	-	27	37	-	0.32	
	20	"	"	1	1	4	-	0.02	
	25	"	"	0	1	1	-	0.007	
	30	"	"	0	0	1	-	0.003	
13-45	0	79.2	280.0	-	-	-	-	-	
	1	"	"	248	275	244	-	2.557	
	2	"	"	1	27	23	-	0.170	
	4	"	"	25	22	23	-	0.233	
	8	"	"	43	24	29	-	0.320	
	12	"	"	25	1	7	-	0.110	
	16	"	"	0	8	13	-	0.070	
	20	"	"	30	6	15	-	0.170	
	25	"	"	17	10	14	-	0.137	
	30	"	"	1	0	4	-	0.017	
	35	"	"	0	0	1	-	0.003	
14-25	40	"	"	0	0	2	-	0.007	
	0	99.6	352.0	-	-	-	-	-	
	1/2	"	"	9	8	7	-	0.080	
	1	"	"	5	3	4	-	0.040	
	2	"	"	19	5	9	-	0.110	
	4	"	"	8	6	16	-	0.100	
	8	"	"	5	0	2	-	0.023	
	12	"	"	6	2	3	-	0.037	
14-41	16	"	"	1	0	1	-	0.007	





APPENDIX II

FINITE ELEMENT PROGRAM

```

LIST
DUMPON
OVERLAY PROGRAM(ABCD)
COMPRESS INTEGER AND LOGICAL
INPUT 1=CR0
OUTPUT 2=LP1
OVERLAY(1,1) TRI AREA 1,RECTCDC,STANDARDISE
OVERLAY(1,2) TRI AREA 2,JOINT GROUP
OVERLAY(1,3) TRI AREA 3,RS STRESSES,PRINT DEFLECTION VECTOR
OVERLAY(1,4) TRI AREA 4,READ LOAD VECTOR
OVERLAY(1,5) RECT AREA 1
OVERLAY(1,6) RECT AREA 2
OVERLAY(1,7) RECT AREA 3
OVERLAY(1,8) RECT AREA 4
OVERLAY(1,9) RECT AREA 5
OVERLAY(1,10) RECT AREA 6
OVERLAY(1,11) DISCOMDIV,RSH DB
OVERLAY(2,1) RFDC
OVERLAY(2,2) RECTWRITE
OVERLAY(3,1) RF AREA 1
OVERLAY(3,2) RF AREA 2
OVERLAY(4,1) RSHELL TRISUB
OVERLAY(4,2) RSHELL RECTSUB
TRACE 2
EXTENDED
END
TRACE 1
MASTER ABCD
INTEGER DOF,DAS,D,RP,RJO,RJT,RJTH,RJF
REAL ITS
DIMENSION DOF(400),D(400),DAS(1201),W(10000),RDC(400),JN(400),
1XC(400),YC(400),LJ(400),RP(400),RJO(400),RJT(400),
2RJTH(400),RJF(400),IR(51),IB(51),B(1200,2),IZ(400),CX(400),CY(400)
DIMENSION XGP(400),YGP(400)
CALL WORKFILE(10,2HED,50000)
CALL WORKFILE(6,2HED,50000)
READ(1,500) I1,I3,I5,I6,I7,I8,NTOT,NL,LAZ,NOG,NOJ,NRP
500 FORMAT(12I0)
IT=I3-1
DO 1 JJ=1,NOG
CALL JOINT GROUP(JJ,DOF,I1,DAS,I3,W,I5,JN,XC,YC,D,LJ,I6,
1LGP,XGP,YGP,NOJ)
CALL RECTANGULAR SHELL GROUP(JJ,DOF,D,I1,DAS,I3,W,I5,RDC,I8,
1JN,XC,YC,LJ,I6,RP,RJO,RJT,RJTH,RJF,I7)
CALL STANDARDISE(JJ,NOG,DAS,I3,IR,IB,NTOT,W,I5)
1 CONTINUE
CALL READ LOAD VECTOR(B,IT,NL)
CALL DISCOMDIV(B,DAS,IR,IB,IT,I3,NTOT,NL)
CALL PRINT DEFLECTION VECTOR(B,IT,NL,NOJ,IZ,LAZ,CX,CY)
CALL GRAPH(NOJ,XGP,YGP,CX,CY)
CALL RS STRESSES(NRP,NL,B,IT)
STOP
END
BLOCK DATA

```

```

REAL ITS
COMMON/AUX/IA(2,2),IF1(13)
COMMON/BUF/ITS(1024)
DATA IA /1,2,4,3/,ITS/1024*0.0/
END
SUBROUTINE STANDARDISE(JJ,NOG,DAS,I3,IR,IB,NTOT,W,I5)          STA 1000
C INITIAL VALUES IN MASTER PROGRAM REFERING TO THIS SUBROUTINE ARE STA 1100
C IL=1000000,IC=0,IE=1,IR(1)=0,IB(1)=0,IK=1 FIRST 512 ITS ELEMENTS =0 STA 1200
  REAL ITS                                                    STA 1300
  INTEGER DAS                                                  STA 1400
  DIMENSION DAS(I3),IR(NTOT),IB(NTOT),W(I5)                 STA 1500
  COMMON/BUF/ITS(1024)                                        STA 1600
  COMMON/AUX/IF1(8),LLH,LS,KR,IC,IE,IK,IL,IF2,IRK
  IF(JJ.GT.1) GO TO 11                                        STA 1800
  IL=1000000                                                STA 1900
  IR(1),IB(1),IC=0                                          STA 2000
  IK,IE,IRK=1                                               STA 2100
11 CONTINUE                                                  STA 2200
  LC=0                                                       STA 2300
  IX=IC                                                       STA 2400
  I=1                                                         STA 2500
  3 IN=DAS(LLH+I)-DAS(LLH+I-1)                               STA 2600
  IF((IC+IN).GT.512) GO TO 1                                STA 2700
  5 IC=IC+IN                                                 STA 2800
  IF(IL.GT.(LLH+I-IN)) IL=LLH+I-IN                          STA 2900
  IF(I.EQ.(LS-LLH)) GO TO 4                                  STA 3000
  I=I+1                                                       STA 3100
  GO TO 3                                                     STA 3200
  1 CONTINUE                                                  STA 3300
  DO 6 IJ=IX+1,IC                                           STA 3400
  6 ITS(IJ)=W(LC+IJ-IX)                                       STA 3500
  CALL PUT PART(10,IRK,ITS,ITS(1),ITS(512))                 STA 3600
  WRITE(2,100)(ITS(IJ),IJ=1,512)
100 FORMAT(1P10E12.4)
  WRITE(2,101)(DAS(IJ),IJ=1,I3)
101 FORMAT(10I10)
  DO 9 IJ=1,512                                              STA 3700
  9 ITS(IJ)=0                                                 STA 3800
  LC=LC+IC-IX                                               STA 3900
  IX,IC=0                                                    STA 4000
  IE=IE+1                                                    STA 4100
  IR(IE)=LLH+I-2                                             STA 4200
  IH=IE-1                                                    STA 4300
  7 IF(IL.GT.IR(IH)) GO TO 8                                  STA 4400
  IH=IH-1                                                    STA 4500
  GO TO 7                                                    STA 4600
  8 IB(IE)=IH                                                STA 4700
  IL=1000000                                                 STA 4800
  IF(I.GT.(LS-LLH)) GO TO 2                                  STA 4900
  GO TO 5                                                    STA 5000
  4 I=I+1                                                    STA 5100
  IF(JJ.EQ.NOG) GO TO 1                                       STA 5200
  DO 10 IJ=IX+1,IC                                          STA 5300
  10 ITS(IJ)=W(LC+IJ-IX)                                       STA 5400

```

2	CONTINUE	STA 5500
	IF(JJ.EQ.NOG) NTOT=IE	STA 5600
	RETURN	STA 5700
	END	STA 5800
	SUBROUTINE JOINT GROUP(JJ,DOF,I1,DAS,I3,W,I5,JN,XC,YC,D,LJ,I6,	
	1LGP,XGP,YGP,NOJ)	
	INTEGER DOF,DAS,D	CLP 4900
	DIMENSION DOF(I1),DAS(I3),W(I5),JN(I6),XC(I6),YC(I6),	
	1D(I1),LJ(I6),XGP(NOJ),YGP(NOJ)	
	COMMON/AUX/IF1(4),LH,LO,LI,K,LLH,LS,KR,IF2(4),LB,IF3	
	IF(JJ.GT.1) GO TO 11	
	LI,LH,LO,LB,DAS(1)=0	
	LGP=0	
	LLH,LS=1	
11	CONTINUE	
	LLH=LS	CLP 5500
	KR=DAS(LLH)	CLP 5600
	READ(1,100) IN,IT	CLP 5700
	IF(JJ.EQ.1) GO TO 2	CLP 5800
	DO 13 I= 1,LO	CLP 5900
	LA=LH+I	CLP 6000
	JN(I)=JN(LA)	CLP 6100
	XC(I)=XC(LA)	CLP 6200
	YC(I)=YC(LA)	CLP 6300
		CLP 6500
13	LJ(I)=LJ(LA)	CLP 6600
	IF(JJ-2) 2,14,0	CLP 6700
	LA=LH+LO	CLP 6800
	DO 1 J=1,LA	CLP 6900
	DOF(J)=DOF(LI+J)	CLP 7000
	1 D(J)=D(LI+J)	CLP 7100
14	LI=LH	CLP 7200
	2 LA=LI+LO	CLP 7300
	LP=LO+IT	
	IF(IT.EQ.0) GO TO 12	
	READ(1,101) (JN(I),XC(I),YC(I),D(LI+I),LJ(I),I=1+LO,LP)	
	DO 200 I=1,IT	
	XGP(I+LGP)=XC(I+LO)	
	YGP(I+LGP)=YC(I+LO)	
200	CONTINUE	CLP 7500
	DO 3 J=1,IT	CLP 7600
	IS=0	
	I=100	
	LP=D(J+LA)	CLP 7800
		CLP 7900
5	I=I/10	CLP 8000
	IF(LP.LT.I) GO TO 4	CLP 8100
	IS=IS+1	CLP 8200
	LP=LP-I	CLP 8300
		CLP 8400
4	IF(I.GT.1) GO TO 5	
	3 DOF(LA+J)=IS	
12	LC=LI	CLP 8600
	IS=IN+LO	CLP 8700
	DO 6 I=1,IS	CLP 8800
	LC=LC+1	CLP 8900
	IF(DOF(LC).EQ.0) GO TO 6	

K=JN(I)	CLP 9000
L=LJ(I)	CLP 9100
M=0	CLP 9200
IF(K.EQ.L) GO TO 7	CLP 9300
N=LC-K+L	CLP 9400
DO 8 J=N,LC-1	CLP 9500
8 M=M+DOF(J)	CLP 9600
7 DO 9 J=1,DOF(LC)	CLP 9700
LB=M+J+LB	CLP 9800
LS=LS+1	CLP 9900
9 DAS(LS)=LB	CLP10000
6 CONTINUE	CLP10100
ISIZE=LB-KR	
WRITE(2,701) ISIZE	
701 FORMAT(45H NUMBER OF LOCATIONS REQUIRED THIS GROUP IN K,I5)	
DO 10 I=1,LB-KR	CLP10200
10 W(I)=0	CLP10300
K=JN(I)	CLP10400
LH=IN+LO	CLP10500
LO=IT-IN	CLP10600
LGP=LGP+IT	
100 FORMAT(2I0)	CLP11800
101 FORMAT(I0,2F0.0,2I0)	
RETURN	CLP12600
END	CLP12700
SUBROUTINE RECTANGULAR SHELL GROUP(JJ,DOF,D,I1,DAS,I3,W,I5,RDC,I8,	
1JN,XC,YC,LJ,I6,RP,RJO,RJT,RJTH,RJF,I7)	
INTEGER RP,RJO,RJT,RJTH,RJF,D,DOF,DAS	RPT 1200
DIMENSION DOF(I1),D(I1),DAS(I3),W(I5),JN(I6),XC(I6),YC(I6),	
* LJ(I6),RP(I7),RJO(I7),RJT(I7),RJTH(I7),RJF(I7),RDC(I8)	RPT 1400
COMMON/RPT/IS,IPOS	
IF(JJ.GT.1) GO TO 9	RPT 1600
IPOS=1	RPT 1700
IS=0	RPT 1800
9 CONTINUE	RPT 2100
READ(1,100) IN,IC	RPT 2200
100 FORMAT(2I0)	RPT 2300
IF(IS.EQ.0) GO TO 2	RPT 2400
DO 1 I=1,IS	RPT 2500
CALL RECTCDC(-IS,I,RJO,RJT,RJTH,RJF,I7,RDC,I8,XC,YC,I6)	
CALL RF AREA 2(RJO(I),RJT(I),RJTH(I),RJF(I),DOF,D,I1,DAS,	RPT 2700
* I3,RDC,I8,W,I5,LJ,I6)	RPT 2800
1 CALL RSH DB(RP(I),RJO(I),RJT(I),RJTH(I),RJF(I),RDC,I8,DOF,D,I1)	RPT 3000
2 IF((IN-IC).EQ.0) GO TO 7	RPT 3100
DO 3 I=1,IN-IC	RPT 3200
READ(1,101) RP(1),RJO(1),RJT(1),RJTH(1),RJF(1)	RPT 3300
101 FORMAT(5I0)	
CALL RECTCDC(0,1,RJO,RJT,RJTH,RJF,I7,RDC,I8,XC,YC,I6)	
CALL RF AREA 1(RJO(1),RJT(1),DOF,D,I1,DAS,I3,RDC,I8,W,I5,	RPT 3500
* LJ,I6)	RPT 3600
CALL RF AREA 2(RJO(1),RJT(1),RJTH(1),RJF(1),DOF,D,I1,	RPT 3700
* DAS,I3,RDC,I8,W,I5,LJ,I6)	RPT 3800
3 CALL RSH DB(RP(1),RJO(1),RJT(1),RJTH(1),RJF(1),RDC,I8,DOF,D,I1)	
7 IF(IC.EQ.0) GO TO 6	RPT 4100

DO 4 I=1,IC	RPT 4200
READ(1,101) RP(I),RJO(I),RJT(I),RJTH(I),RJF(I)	RPT 4000
CALL RECTCDC(1,I,RJO,RJT,RJTH,RJF,I7,RDC,I8,XC,YC,I6)	
4 CALL RF AREA 1(RJO(I),RJT(I),DOF,D,I1,DAS,I3,RDC,I8,	RPT 4400
* W,I5,LJ,I6)	RPT 4500
L=IC*19	
M=L	RPT 4700
DO 8 I=1,M	RPT 4800
RDC(L+19)=RDC(L)	
8 L=L-1	RPT 5000
6 IS=IC	RPT 5100
RETURN	RPT 5200
END	RPT 5300
SUBROUTINE RECTCDC(J,I,RJO,RJT,RJTH,RJF,I7,RDC,I8,XC,YC,I6)	
INTEGER RJO,RJT,RJTH,RJF	RPT 5600
DIMENSION RJO(I7),RJT(I7),RJTH(I7),RJF(I7),RDC(I8),XC(I6),YC(I6)	
IF(J) 0,2,3	RPT 5700
L=19*(-J-I+1)	
DO 4 K=1,19	
L=L+1	RPT 6100
4 RDC(K)=RDC(L)	RPT 6200
GO TO 7	RPT 6000
2 READ(1,101) E	RPT 6300
101 FORMAT(F0.0)	RPT 6400
IF(E.LT.0.0) GO TO 5	
RDC(1)=E	RPT 6600
READ(1,100) RDC(2),RDC(19)	
100 FORMAT(2F0.0)	
5 CALL RFDC(I,RJO,RJT,RJTH,RJF,I7,RDC,I8,XC,YC,I6)	
GO TO 7	RPT 7000
3 K=19*I	
KK=19*(I-1)	
8 IF(KK.EQ.0) GO TO 2	RPT 7300
RDC(K)=RDC(KK)	RPT 7400
K=K-1	RPT 7500
KK=KK-1	RPT 7600
GO TO 8	RPT 7700
7 CONTINUE	RPT 7800
RETURN	RPT 7900
END	RPT 8000
SUBROUTINE RFDC(I,RJO,RJT,RJTH,RJF,I7,RDC,I8,XC,YC,I6)	
INTEGER RJO,RJT,RJTH,RJF	
DIMENSION RJO(I7),RJT(I7),RJTH(I7),RJF(I7),RDC(I8),XC(I6),YC(I6)	
COMMON/AUX/IF1(7),K,IF2(9)	
MO=RJO(I)-K+1	RPT 8500
MT=RJT(I)-K+1	RPT 8600
MTH=RJTH(I)-K+1	RPT 8700
MF=RJF(I)-K+1	
RDC(3)=XC(MT)-XC(MO)	
RDC(4)=YC(MT)-YC(MO)	
RDC(5)=XC(MTH)-XC(MO)	
RDC(6)=YC(MTH)-YC(MO)	
RDC(7)=XC(MF)-XC(MTH)	
RDC(8)=YC(MF)-YC(MTH)	

```

RDC(9)=XC(MF)-XC(MT)
RDC(10)=YC(MF)-YC(MT)
RDC(11)=XC(MF)-XC(MO)
RDC(12)=YC(MF)-YC(MO)
RDC(13)=XC(MTH)-XC(MT)
RDC(14)=YC(MTH)-YC(MT)
RETURN
END
SUBROUTINE RF AREA 1(L,LL,DOF,D,I1,DAS,I3,RDC,I8,W,I5,LJ,I6)      RPT11700
INTEGER DOF,D,DAS                                               RPT11800
DIMENSION DOF(I1),LJ(I6),D(I1),DAS(I3),W(I5),RDC(I8)          RPT11900
COMMON/AUX/IF1(6),LI,K,IF2(9)
M=L-K                                                           RPT12100
MM=LL-K                                                         RPT12200
IF(DOF(LI+1+M).EQ.0) GO TO 3                                   RPT12300
CALL RSHELL TRISUB(M,1,DOF,D,I1,DAS,I3,RDC,I8,W,I5)
IF(DOF(LI+1+MM).EQ.0) GO TO 4                                   RPT12500
CALL RSHELL RECTSUB(MM,M,L,1,D,DOF,I1,DAS,I3,RDC,I8,W,I5,LJ,I6)
GO TO 5                                                         RPT12700
3 IF(DOF(LI+1+MM).EQ.0) GO TO 4                                 RPT12800
5 CALL RSHELL TRISUB(MM,2,DOF,D,I1,DAS,I3,RDC,I8,W,I5)
4 RETURN                                                         RPT13000
END                                                             RPT13100
SUBROUTINE RF AREA 2(L1,L2,L3,L4,DOF,D,I1,DAS,I3,RDC,I8,
* W,I5,LJ,I6)                                                  RPT13200
INTEGER DOF,D,DAS                                               RPT13300
DIMENSION DOF(I1),LJ(I6),D(I1),DAS(I3),W(I5),RDC(I8)          RPT13400
COMMON/AUX/IF1(6),LI,K,IF2(9)                                   RPT13500
M1=L1-K                                                         RPT13700
M2=L2-K                                                         RPT13800
M3=L3-K                                                         RPT13900
M4=L4-K                                                         RPT14000
IF(DOF(LI+1+M1).EQ.0) GO TO 1                                   RPT14100
IF(DOF(LI+1+M3).EQ.0) GO TO 2                                   RPT14200
CALL RSHELL RECTSUB(M3,M1,L1,2,D,DOF,I1,DAS,I3,RDC,I8,W,I5,LJ,I6)
2 IF(DOF(LI+1+M4).EQ.0) GO TO 1                                   RPT14400
CALL RSHELL RECTSUB(M4,M1,L1,4,D,DOF,I1,DAS,I3,RDC,I8,W,I5,LJ,I6)
1 IF(DOF(LI+1+M2).EQ.0) GO TO 3                                   RPT14600
IF(DOF(LI+1+M3).EQ.0) GO TO 4                                   RPT14700
CALL RSHELL RECTSUB(M3,M2,L2,3,D,DOF,I1,DAS,I3,RDC,I8,W,I5,LJ,I6)
4 IF(DOF(LI+1+M4).EQ.0) GO TO 3                                   RPT14900
CALL RSHELL RECTSUB(M4,M2,L2,5,D,DOF,I1,DAS,I3,RDC,I8,W,I5,LJ,I6)
3 IF(DOF(LI+1+M3).EQ.0) GO TO 5                                   RPT15100
CALL RSHELL TRISUB(M3,3,DOF,D,I1,DAS,I3,RDC,I8,W,I5)
IF(DOF(LI+1+M4).EQ.0) GO TO 6                                   RPT15300
CALL RSHELL RECTSUB(M4,M3,L3,6,D,DOF,I1,DAS,I3,RDC,I8,W,I5,LJ,I6)
5 IF(DOF(LI+1+M4).EQ.0) GO TO 6                                   RPT15500
CALL RSHELL TRISUB(M4,4,DOF,D,I1,DAS,I3,RDC,I8,W,I5)
6 RETURN                                                         RPT15700
END                                                             RPT15800
SUBROUTINE RSHELL RECTSUB(MR,MC,LC,IREF,D,DOF,I1,DAS,I3,
* RDC,I8,W,I5,LJ,I6)
INTEGER DOF,D,DAS                                               RPT16000
DIMENSION DOF(I1),LJ(I6),D(I1),DAS(I3),W(I5),RDC(I8)          RPT16100
RPT16200

```



```

COMMON/AUX/IF1(6),LI,K,IF2(9)
N=0
IF(MR.EQ.0) GO TO 4
DO 1 J=LI+1,LI+MR
1 N=DOF(J)+N
4 NN=LJ(MR+1)
  JJ=0
  IF(NN.EQ.LC) GO TO 2
  LK=NN-K
  DO 3 J=LK+LI+1,LI+MC
3 JJ=JJ+DOF(J)
2 CONTINUE
  CALL RECT WRITE(IREF,2,N,D(LI+MR+1),DOF(LI+MR+1),JJ,D(LI+MC+1),
*   DOF(LI+MC+1),DAS,I3,RDC,I8,W,I5)
  RETURN
END
SUBROUTINE RSHELL TRISUB(MR,IREF,DOF,D,I1,DAS,I3,RDC,I8,W,I5)
INTEGER DOF,D,DAS
DIMENSION DOF(I1),D(I1),DAS(I3),W(I5),RDC(I8)
COMMON/AUX/IF1(6),LI,IF2,LLH,LS,KR,IF3(6)
N=0
IF(MR.EQ.0) GO TO 1
DO 2 J=LI+1,MR+LI
2 N=DOF(J)+N
1 CONTINUE
  RDC(14+IREF)=FLOAT(N+LLH)
  CALL RECT WRITE(IREF,0,N,D(LI+MR+1),DOF(LI+MR+1),0,0,0,DAS,I3,
*   RDC,I8,W,I5)
  RETURN
END
SUBROUTINE RECTWRITE(IJK,IAN,NN,IF,JF,JJ,IG,JG,DAS,I3,RDC,I8,W,I5)
INTEGER DAS
DIMENSION DAS(I3),RDC(I8),W(I5),XQ(3),PH(3,3),WT(3),QA(3,3),
1AW(3,3),BW(3,3),CW(3,3),DW(3,3),EW(3,3),FW(3,3),GW(3,3),HW(3,3)
COMMON/BLKB/E,U,T,EV,EY,DUA(2)
N=NN
E=RDC(1)
U=RDC(2)
T=RDC(19)
UU=2*(1+U)
UU1=(1-U)/((1+U)*(1-2*U))
EV=E*T*UU1
EY=E*T/UU
U=U/(1-U)
A1=RDC(14)
A2=RDC(12)
B1=RDC(8)
B2=RDC(4)
C1=RDC(10)
C2=RDC(6)
D1=RDC(13)
D2=RDC(11)
E1=RDC(7)
E2=RDC(3)

```

RPT16400  
RPT16500  
RPT16600  
RPT16700  
RPT16800  
RPT16900  
RPT17000  
RPT17100  
RPT17200  
RPT17300  
RPT17400  
RPT17500  
RPT17600  
RPT17700  
RPT17800  
  
RPT18000  
RPT18100  
  
RPT18300  
RPT18400  
RPT18500  
RPT18600  
RPT18700  
  
RPT18900  
RPT19000  
RPT19100  
RPT19200

```

F1=RDC(9)
F2=RDC(5)
XQ(3)=SQRT(0.6)
XQ(2)=0.0
XQ(1)=-XQ(3)
WT(1)=5.0/9.0
WT(2)=8.0/9.0
WT(3)=WT(1)
DO 21 I=1,3
DO 21 J=1,3
AW(I,J)=A1+B1*XQ(I)-C1*XQ(J)
BW(I,J)=-A2-B1*XQ(I)+C2*XQ(J)
CW(I,J)=A2-B2*XQ(I)+C1*XQ(J)
DW(I,J)=-A1+B2*XQ(I)-C2*XQ(J)
EW(I,J)=-D1-E1*XQ(I)+F1*XQ(J)
FW(I,J)=D2+E1*XQ(I)-F2*XQ(J)
GW(I,J)=-D2+E2*XQ(I)-F1*XQ(J)
HW(I,J)=D1-E2*XQ(I)+F2*XQ(J)
PH(I,J)=-D2*A1+D1*A2+(-E2*B1+E1*B2)*XQ(I)+(F2*C1-F1*C2)*XQ(J)
21 QA(I,J)=-0.125*WT(I)*WT(J)/PH(I,J)
IF(IAN.GT.0)GO TO 10
GO TO (1,2,3,4),IJK
1 CALL TRI AREA 1(IAN,N,DAS,I3,W,I5,RDC,I8,IF,JF,JJ,IG,JG,AW,BW,
1CW,DW,EW,FW,GW,HW,QA)
GO TO 11
2 CALL TRI AREA 2(IAN,N,DAS,I3,W,I5,RDC,I8,IF,JF,JJ,IG,JG,AW,BW,
1CW,DW,EW,FW,GW,HW,QA)
GO TO 11
3 CALL TRI AREA 3(IAN,N,DAS,I3,W,I5,RDC,I8,IF,JF,JJ,IG,JG,AW,BW,
1CW,DW,EW,FW,GW,HW,QA)
GO TO 11
4 CALL TRI AREA 4(IAN,N,DAS,I3,W,I5,RDC,I8,IF,JF,JJ,IG,JG,AW,BW,
1CW,DW,EW,FW,GW,HW,QA)
GO TO 11
10 CONTINUE
GO TO (100,200,300,400,500,600),IJK
100 CALL RECT AREA 1(IAN,N,DAS,I3,W,I5,RDC,I8,IF,JF,JJ,IG,JG,AW,BW,
1CW,DW,EW,FW,GW,HW,QA)
GO TO 11
200 CALL RECT AREA 2(IAN,N,DAS,I3,W,I5,RDC,I8,IF,JF,JJ,IG,JG,AW,BW,
1CW,DW,EW,FW,GW,HW,QA)
GO TO 11
300 CALL RECT AREA 3(IAN,N,DAS,I3,W,I5,RDC,I8,IF,JF,JJ,IG,JG,AW,BW,
1CW,DW,EW,FW,GW,HW,QA)
GO TO 11
400 CALL RECT AREA 4(IAN,N,DAS,I3,W,I5,RDC,I8,IF,JF,JJ,IG,JG,AW,BW,
1CW,DW,EW,FW,GW,HW,QA)
GO TO 11
500 CALL RECT AREA 5(IAN,N,DAS,I3,W,I5,RDC,I8,IF,JF,JJ,IG,JG,AW,BW,
1CW,DW,EW,FW,GW,HW,QA)
GO TO 11
600 CALL RECT AREA 6(IAN,N,DAS,I3,W,I5,RDC,I8,IF,JF,JJ,IG,JG,AW,BW,
1CW,DW,EW,FW,GW,HW,QA)
11 RETURN

```

```

END
SUBROUTINE TRI AREA 1( IAN,N,DAS,I3,W,I5,RDC,I8,IF,JF,JJ,IG,JG,
1AW,BW,CW,DW,EW,FW,GW,HW,QA)
  INTEGER DAS
  DIMENSION DAS(I3),W(I5),RDC(I8),QA(3,3),AW(3,3),BW(3,3),CW(3,3),
1DW(3,3),EW(3,3),FW(3,3),GW(3,3),HW(3,3)
  COMMON/BLKB/E,U,T,EV,EY,DUA(2)
  COMMON/BLKC/ZA,ZB,ZC,ZD,DUB(2)
  AA,AE,EE=0.0
  DO 1 I=1,3
  DO 1 J=1,3
  AA=QA(I,J)*AW(I,J)*AW(I,J)+AA
  AE=QA(I,J)*AW(I,J)*EW(I,J)+AE
1 EE=QA(I,J)*EW(I,J)*EW(I,J)+EE
  ZA=EV*AA+EY*EE
  ZB=(EV*U+EY)*AE
  ZC=EV*EE+EY*AA
  CALL KWRITE(IAN,N,IF,JF,JJ,IG,JG,DAS,I3,RDC,I8,W,I5)
  RETURN
END
SUBROUTINE TRI AREA 2( IAN,N,DAS,I3,W,I5,RDC,I8,IF,JF,JJ,IG,JG,
1AW,BW,CW,DW,EW,FW,GW,HW,QA)
  INTEGER DAS
  DIMENSION DAS(I3),W(I5),RDC(I8),QA(3,3),AW(3,3),BW(3,3),CW(3,3),
1DW(3,3),EW(3,3),FW(3,3),GW(3,3),HW(3,3)
  COMMON/BLKB/E,U,T,EV,EY,DUA(2)
  COMMON/BLKC/ZA,ZB,ZC,ZD,DUB(2)
  BB,BF,FF=0.0
  DO 1 I=1,3
  DO 1 J=1,3
  BB=QA(I,J)*BW(I,J)*BW(I,J)+BB
  BF=QA(I,J)*BW(I,J)*FW(I,J)+BF
1 FF=QA(I,J)*FW(I,J)*FW(I,J)+FF
  ZA=EV*BB+EY*FF
  ZB=(EV*U+EY)*BF
  ZC=EV*FF+EY*BB
  CALL KWRITE(IAN,N,IF,JF,JJ,IG,JG,DAS,I3,RDC,I8,W,I5)
  RETURN
END
SUBROUTINE TRI AREA 3( IAN,N,DAS,I3,W,I5,RDC,I8,IF,JF,JJ,IG,JG,
1AW,BW,CW,DW,EW,FW,GW,HW,QA)
  INTEGER DAS
  DIMENSION DAS(I3),W(I5),RDC(I8),QA(3,3),AW(3,3),BW(3,3),CW(3,3),
1DW(3,3),EW(3,3),FW(3,3),GW(3,3),HW(3,3)
  COMMON/BLKB/E,U,T,EV,EY,DUA(2)
  COMMON/BLKC/ZA,ZB,ZC,ZD,DUB(2)
  CC,CG,GG=0.0
  DO 1 I=1,3
  DO 1 J=1,3
  CC=QA(I,J)*CW(I,J)*CW(I,J)+CC
  CG=QA(I,J)*CW(I,J)*GW(I,J)+CG
1 GG=QA(I,J)*GW(I,J)*GW(I,J)+GG
  ZA=EV*CC+EY*GG
  ZB=(EV*U+EY)*CG

```

```

ZC=EV*GG+EY*CC
CALL KWRITE(IAN,N,IF,JF,JJ,IG,JG,DAS,I3,RDC,I8,W,I5)
RETURN
END
SUBROUTINE TRI AREA 4(IAN,N,DAS,I3,W,I5,RDC,I8,IF,JF,JJ,IG,JG,
LAW,BW,CW,DW,EW,FW,GW,HW,QA)
INTEGER DAS
DIMENSION DAS(I3),W(I5),RDC(I8),QA(3,3),AW(3,3),BW(3,3),CW(3,3),
1DW(3,3),EW(3,3),FW(3,3),GW(3,3),HW(3,3)
COMMON/BLKB/E,U,T,EV,EY,DUA(2)
COMMON/BLKC/ZA,ZB,ZC,ZD,DUB(2)
DD,DH,HH=0.0
DO 1 I=1,3
DO 1 J=1,3
DD=QA(I,J)*DW(I,J)*DW(I,J)+DD
DH=QA(I,J)*DW(I,J)*HW(I,J)+DH
1 HH=QA(I,J)*HW(I,J)*HW(I,J)+HH
ZA=EV*DD+EY*HH
ZB=(EV*U+EY)*DH
ZC=EV*HH+EY*DD
CALL KWRITE(IAN,N,IF,JF,JJ,IG,JG,DAS,I3,RDC,I8,W,I5)
RETURN
END
SUBROUTINE RECT AREA 1(IAN,N,DAS,I3,W,I5,RDC,I8,IF,JF,JJ,IG,JG,
LAW,BW,CW,DW,EW,FW,GW,HW,QA)
INTEGER DAS
DIMENSION DAS(I3),W(I5),RDC(I8),QA(3,3),AW(3,3),BW(3,3),CW(3,3),
1DW(3,3),EW(3,3),FW(3,3),GW(3,3),HW(3,3)
COMMON/BLKB/E,U,T,EV,EY,DUA(2)
COMMON/BLKC/ZA,ZB,ZC,ZD,DUB(2)
AB,EF,AF,BE=0.0
DO 1 I=1,3
DO 1 J=1,3
AB=QA(I,J)*AW(I,J)*BW(I,J)+AB
EF=QA(I,J)*EW(I,J)*FW(I,J)+EF
AF=QA(I,J)*AW(I,J)*FW(I,J)+AF
1 BE=QA(I,J)*BW(I,J)*EW(I,J)+BE
ZA=EV*AB+EY*EF
ZB=EV*U*AF+EY*BE
ZC=EV*EF+EY*AB
ZD=EV*U*BE+EY*AF
CALL KWRITE(IAN,N,IF,JF,JJ,IG,JG,DAS,I3,RDC,I8,W,I5)
RETURN
END
SUBROUTINE RECT AREA 2(IAN,N,DAS,I3,W,I5,RDC,I8,IF,JF,JJ,IG,JG,
LAW,BW,CW,DW,EW,FW,GW,HW,QA)
INTEGER DAS
DIMENSION DAS(I3),W(I5),RDC(I8),QA(3,3),AW(3,3),BW(3,3),CW(3,3),
1DW(3,3),EW(3,3),FW(3,3),GW(3,3),HW(3,3)
COMMON/BLKB/E,U,T,EV,EY,DUA(2)
COMMON/BLKC/ZA,ZB,ZC,ZD,DUB(2)
AC,EG,AG,CE=0.0
DO 1 I=1,3
DO 1 J=1,3

```

```

AC=QA(I,J)*AW(I,J)*CW(I,J)+AC
EG=QA(I,J)*EW(I,J)*GW(I,J)+EG
AG=QA(I,J)*AW(I,J)*GW(I,J)+AG
1 CE=QA(I,J)*CW(I,J)*EW(I,J)+CE
ZA=EV*AC+EY*EG
ZB=EV*U*AG+EY*CE
ZC=EV*EG+EY*AC
ZD=EV*U*CE+EY*AG
CALL KWRITE(IAN,N,IF,JF,JJ,IG,JG,DAS,I3,RDC,I8,W,I5)
RETURN
END
SUBROUTINE RECT AREA 3(IAN,N,DAS,I3,W,I5,RDC,I8,IF,JF,JJ,IG,JG,
LAW,BW,CW,DW,EW,FW,GW,HW,QA)
INTEGER DAS
DIMENSION DAS(I3),W(I5),RDC(I8),QA(3,3),AW(3,3),BW(3,3),CW(3,3),
LDW(3,3),EW(3,3),FW(3,3),GW(3,3),HW(3,3)
COMMON/BLKB/E,U,T,EV,EY,DUA(2)
COMMON/BLKC/ZA,ZB,ZC,ZD,DUB(2)
BC,FG,BG,CF=0.0
DO 1 I=1,3
DO 1 J=1,3
BC=QA(I,J)*BW(I,J)*CW(I,J)+BC
FG=QA(I,J)*FW(I,J)*GW(I,J)+FG
BG=QA(I,J)*BW(I,J)*GW(I,J)+BG
1 CF=QA(I,J)*CW(I,J)*FW(I,J)+CF
ZA=EV*BC+EY*FG
ZB=EV*U*BG+EY*CF
ZC=EV*FG+EY*BC
ZD=EV*U*CF+EY*BG
CALL KWRITE(IAN,N,IF,JF,JJ,IG,JG,DAS,I3,RDC,I8,W,I5)
RETURN
END
SUBROUTINE RECT AREA 4(IAN,N,DAS,I3,W,I5,RDC,I8,IF,JF,JJ,IG,JG,
LAW,BW,CW,DW,EW,FW,GW,HW,QA)
INTEGER DAS
DIMENSION DAS(I3),W(I5),RDC(I8),QA(3,3),AW(3,3),BW(3,3),CW(3,3),
LDW(3,3),EW(3,3),FW(3,3),GW(3,3),HW(3,3)
COMMON/BLKB/E,U,T,EV,EY,DUA(2)
COMMON/BLKC/ZA,ZB,ZC,ZD,DUB(2)
AD,EH,AH,DE=0.0
DO 1 I=1,3
DO 1 J=1,3
AD=QA(I,J)*AW(I,J)*DW(I,J)+AD
EH=QA(I,J)*EW(I,J)*HW(I,J)+EH
AH=QA(I,J)*AW(I,J)*HW(I,J)+AH
1 DE=QA(I,J)*DW(I,J)*EW(I,J)+DE
ZA=EV*AD+EY*EH
ZB=EV*U*AH+EY*DE
ZC=EV*EH+EY*AD
ZD=EV*U*DE+EY*AH
CALL KWRITE(IAN,N,IF,JF,JJ,IG,JG,DAS,I3,RDC,I8,W,I5)
RETURN
END
SUBROUTINE RECT AREA 5(IAN,N,DAS,I3,W,I5,RDC,I8,IF,JF,JJ,IG,JG,

```

```

LAW, BW, CW, DW, EW, FW, GW, HW, QA)
  INTEGER DAS
  DIMENSION DAS(I3), W(I5), RDC(I8), QA(3,3), AW(3,3), BW(3,3), CW(3,3),
1DW(3,3), EW(3,3), FW(3,3), GW(3,3), HW(3,3)
  COMMON/BLKB/E, U, T, EV, EY, DUA(2)
  COMMON/BLKC/ZA, ZB, ZC, ZD, DUB(2)
  BD, FH, BH, DF=0.0
  DO 1 I=1,3
  DO 1 J=1,3
  BD=QA(I,J)*BW(I,J)*DW(I,J)+BD
  FH=QA(I,J)*FW(I,J)*HW(I,J)+FH
  BH=QA(I,J)*BW(I,J)*HW(I,J)+BH
1 DF=QA(I,J)*DW(I,J)*FW(I,J)+DF
  ZA=EV*BD+EY*FH
  ZB=EV*U*BH+EY*DF
  ZC=EV*FH+EY*BD
  ZD=EV*U*DF+EY*BH
  CALL KWRITE(IAN,N,IF,JF,JJ,IG,JG,DAS,I3,RDC,I8,W,I5)
  RETURN
  END
  SUBROUTINE RECT AREA 6(IAN,N,DAS,I3,W,I5,RDC,I8,IF,JF,JJ,IG,JG,
1AW, BW, CW, DW, EW, FW, GW, HW, QA)
  INTEGER DAS
  DIMENSION DAS(I3), W(I5), RDC(I8), QA(3,3), AW(3,3), BW(3,3), CW(3,3),
1DW(3,3), EW(3,3), FW(3,3), GW(3,3), HW(3,3)
  COMMON/BLKB/E, U, T, EV, EY, DUA(2)
  COMMON/BLKC/ZA, ZB, ZC, ZD, DUB(2)
  CD, GH, CH, DG=0.0
  DO 1 I=1,3
  DO 1 J=1,3
  CD=QA(I,J)*CW(I,J)*DW(I,J)+CD
  GH=QA(I,J)*GW(I,J)*HW(I,J)+GH
  CH=QA(I,J)*CW(I,J)*HW(I,J)+CH
1 DG=QA(I,J)*DW(I,J)*GW(I,J)+DG
  ZA=EV*CD+EY*GH
  ZB=EV*U*CH+EY*DG
  ZC=EV*GH+EY*CD
  ZD=EV*U*DG+EY*CH
  CALL KWRITE(IAN,N,IF,JF,JJ,IG,JG,DAS,I3,RDC,I8,W,I5)
  RETURN
  END
  SUBROUTINE KWRITE(IAN,N,IF,JF,JJ,IG,JG,DAS,I3,RDC,I8,W,I5)
  INTEGER DAS
  DIMENSION DAS(I3), W(I5), IR(2), IC(2), RDC(I8)
  COMMON/AUX/IP(2,2), IF1(4), LLH, LS, KR, IF2(6)
  COMMON/BLKC/ZA, ZB, ZC, ZD, DUB(2)
  WRITE(0,200) I3
  WRITE(0,200) DAS(I3)
200 FORMAT(6I10)
  IF(IAN.GT.0)GO TO 6
  ASSIGN 120 TO N1207
  CALL SET(IF,IR)
  J=0
110 J=J+1

```

```

IF(J.GT.JF)GO TO 140
N=N+1
L=DAS(LLH+N)-KR-J+1
I=0
130 I=I+1
IF(I.GT.J)GO TO 110
II=IP(IR(J),IR(I))
GO TO(11,21,22),II
120 L=L+1
GO TO 130
6 ASSIGN 7 TO N1207
CALL SET(IF,IR)
CALL SET(IG,IC)
J=0
WRITE(0,200) JJ,N,J,LLH,KR,DAS(6)
8 L=JJ+DAS(N+J+LLH)-KR+1
J=J+1
IF(J.GT.JF)GO TO 140
K=0
9 K=K+1
IF(K.GT.JG)GO TO 8
II=IP(IR(J),IC(K))
GO TO(11,21,22,12),II
7 L=L+1
GO TO 9

```

C  
C

```

-----
WRITE OVERALL STIFFNESS MATRIX TERMS
11 W(L)=ZA+W(L)
GO TO N1207
12 W(L)=ZD+W(L)
GO TO N1207
21 W(L)=ZB+W(L)
GO TO N1207
22 W(L)=ZC+W(L)
GO TO N1207
140 L=L-1
RETURN
END
SUBROUTINE RSH DB(PN,N1,N2,N3,N4,RDC,I8,DOF,D,I1)
INTEGER D,DOF,PN,E1,E2,E3
DIMENSION RDC(I8),DOF(I1),D(I1),IN(2),S(160),IRN(4)
COMMON/AUX/IF1(6),LI,K,IF2(9)
COMMON/BLKB/E,U,T,EV,EY,DUA(2)
COMMON/RPT/IF3,IPOS
IRN(1)=N1
IRN(2)=N2
IRN(3)=N3
IRN(4)=N4
YM=RDC(1)
U=RDC(2)
DO 9JWA=1,5
GO TO (11,12,13,14,15),JWA
11 IPA,IQA=-1
GO TO 50

```

```

12 IPA=1
   IQA=-1
   GO TO 50
13 IPA=-1
   IQA=1
   GO TO 50
14 IPA,IQA=1
   GO TO 50
15 IPA,IQA=0
50 AW=RDC(14)+RDC(8)*IPA-RDC(10)*IQA
   BW=-RDC(12)-RDC(8)*IPA+RDC(6)*IQA
   CW=RDC(12)-RDC(4)*IPA+RDC(10)*IQA
   DW=-RDC(14)+RDC(4)*IPA-RDC(6)*IQA
   EW=-RDC(13)-RDC(7)*IPA+RDC(9)*IQA
   FW=RDC(11)+RDC(7)*IPA-RDC(5)*IQA
   GW=-RDC(11)+RDC(3)*IPA-RDC(9)*IQA
   HW=RDC(13)-RDC(3)*IPA+RDC(5)*IQA
   PH=-RDC(11)*RDC(14)+RDC(13)*RDC(12)+(RDC(7)*RDC(4)-RDC(3)*RDC(8))
1*IPA+(RDC(5)*RDC(10)-RDC(9)*RDC(6))*IQA
   DO 8 JOT=1,4
   LLI=LI+IRN(JOT)-K+1
   CALL SET(D(LLI),IN)
   IA=DOF(LLI)
   ILL=8*(JOT-1)+32*(JWA-1)
   J=0
6 J=J+1
  IF(J.GT.IA)GO TO 7
  II=IN(J)
  GO TO (1,2,3,4),JOT
1 A=AW
  B=EW
  GO TO (10,20),II
2 A=BW
  B=FW
  GO TO (10,20),II
3 A=CW
  B=GW
  GO TO (10,20),II
4 A=DW
  B=HW
  GO TO (10,20),II
10 MA=1
   MB=0
   GO TO 5
20 MA=0
   MB=1
5 S(ILL+J)=(EV*A*MA+EV*U*B*MB)/PH
  S(ILL+J+IA)=(EV*U*A*MA+EV*B*MB)/PH
  S(ILL+J+2*IA)=(EY*B*MA+EY*A*MB)/PH
  GO TO 6
7 S(ILL+7)=RDC(14+JOT)
8 S(ILL+8)=FLOAT(IA)
9 CONTINUE
C WRITE CONTENTS OF S(1:160) TO DISC 6

```



```

CALL PUT PART(6,IPOS,S,S(1),S(160))
RETURN
END
SUBROUTINE RS STRESSES(NRP,NL,B,ND)
DIMENSION S(160),SI(3),B(ND,NL),TF(15)
DO 8 ILC=1,NL
WRITE(2,500) ILC
500 FORMAT(1H1,11H LOAD CASE ,I2//16X,'QUADRILATERAL ELEMENTS IN PLANE
1 STRAIN:  FORCES PER UNIT WIDTH (NX,NY,NXY)'/40X,'-----
2-----'//20X,6HNODE 1,9X,6HNODE 2,9X,6HNODE 3,9X,6HNODE 4,9X,6HCENTR
3E//3X,7HELEMENT,12X,2HNX,13X,2HNX,13X,2HNX,13X,2HNX,13X,2HNX/3X,6H
4NUMBER,13X,2HNY,13X,2HNY,13X,2HNY,13X,2HNY,13X,2HNY/22X,3HXY,12X,
53HXY,12X,3HXY,12X,3HXY,12X,3HXY/)
IPOS=1
DO 7 II=1,NRP
CALL GET PART(6,IPOS,S,S(1),S(160))
DO 4 JWA=1,5
DO 5 ILL=1,3
5 SI(ILL)=0.0
DO 9 ICN=1,4
IWA=32*(JWA-1)
IA=IFIX(S(8*ICN+IWA))
IF(IA.EQ.0)GO TO 9
IJ=8*ICN-1+IWA
IP=IFIX(S(IJ))-1
IJ=8*(ICN-1)+IWA
DO 1 IROW=1,3
DO 1 ICOL=1,IA
1 SI(IROW)=B(IP+ICOL,ILC)*S(IJ+ICOL+IA*(IROW-1))+SI(IROW)
9 CONTINUE
JXW=3*(JWA-1)
DO 10 IROW=1,3
10 TF(IROW+JXW)=SI(IROW)
4 CONTINUE
7 WRITE(2,501) II,((TF(1+3*(IT-1)),IT=1,5),(TF(2+3*(IT-1)),IT=1,5),
1(TF(3+3*(IT-1)),IT=1,5))
501 FORMAT(I7,6X,1P5E15.4/13X,1P5E15.4/13X,1P5E15.4)
8 WRITE(2,502)
502 FORMAT(//5X,'SIGN CONVENTION : FORCES ARE POSITIVE WHEN ACTING ALO
1NG POSITIVE AXES')
RETURN
END
SUBROUTINE SET(IF,IR)
DIMENSION IR(2)
IH=IF
I=1
M=1
J=100
2 J=J/10
IF(IH.LT.J) GO TO 1
IR(M)=I
M=M+1
IH=IH-J
1 I=I+1
SET 1600
SET 1700
SET 1800
SET 1900
SET 2000
SET 2100

```

```

IF(J.GT.1) GO TO 2
RETURN
END
SUBROUTINE READ LOAD VECTOR(B,IT,NL)
DIMENSION B(IT,NL)
DO 1 J=1,NL
DO 1 I=1,IT
1 B(I,J)=0
DO 2 J=1,NL
READ(1,100) NV
100 FORMAT(I0)
DO 2 I=1,NV
READ(1,200) IC,VAL
200 FORMAT(I0,F0.0)
2 B(IC,J)=VAL
RETURN
END
SUBROUTINE PRINT DEFLECTION VECTOR(B,IT,NL,NOJ,IZ,LAZ,CX,CY)
DIMENSION B(IT,NL),HB(2),IZ(LAZ),CX(NOJ),CY(NOJ)
READ(1,101) (IZ(II),II=1,LAZ)
101 FORMAT(10I0)
DO 5 LC=1,NL
WRITE(2,600) LC
600 FORMAT(1H1////////40X,22H DEFLEXIONS LOAD CASE ,I2/40X,' -----
1-----'///5X,'SIGN CONVENTION : DEFLEXIONS ARE POSITIVE WHEN
2 ACTING ALONG POSITIVE AXES'///15X,'JOINT NUMBER',21X,'X',19X,'Y')
J=1
I=1
DO 5 K=1,NOJ
DO 7 II=1,2
7 HB(II)=0.0
L=1
IL=2*(K-1)+1
2 IF(IL.GT.2*K)GO TO4
IF(J.GT.LAZ)GO TO 6
IF(IZ(J).EQ.IL)GO TO 3
6 IF(L.GT.2)GO TO 4
HB(L)=B(I,LC)
L=L+1
I=I+1
IL=IL+1
GO TO 2
3 J=J+1
L=L+1
IL=IL+1
GO TO 2
4 WRITE(2,700) K,(HB(II),II=1,2)
700 FORMAT(17X,I5,12X,1P2E20.5)
CX(K)=HB(1)
CY(K)=HB(2)
5 CONTINUE
RETURN
END
TRACE 1

```

```

SET 2200
SET 2300
SET 2400
RLV 1000
RLV 1100
RLV 1200
RLV 1300
RLV 1400
RLV 1500
RLV 1600
RLV 1700
RLV 1800
RLV 1900
RLV 2000
RLV 2100
RLV 2200
RLV 2300
PDV
PDV 1200
PDV 1300
PDV 1400
PDV 1500
PDV 3300
PDV 3400
PDV 3500
PDV 3600
PDV 3700
PDV 3800
PDV 4100
PDV 4200
PDV 4300

```

	SUBROUTINE DISCOMDIV(B, IS, IR, IB, N, NIS, NTOT, NRHS)	DIV 1000
	INTEGER H, P, Q, R, T, U, V, QQ, HP, HQ, HL	DIV 1100
C	HP HQ HL ARE INSERTIONS NECESSAITATED BY 1905 SYSTEM	DIV 1200
	DIMENSION B(N, NRHS), IS(NIS), IR(NTOT), IB(NTOT)	DIV 1300
	COMMON/BUF/A(1024)	DIV 1400
C	MAIN SOLUTION ROUTINE JENNINGS AND TUFF	DIV 1500
	NTOT=NTOT-1	DIV 1600
	P=1	DIV 1700
10	Q=IB(P+1)	DIV 1800
	IF(Q-P+1) 0,20,30	DIV 1900
	IF(Q-P+2) 0,30,0	DIV 2000
	HQ=512*(Q-1)+1	DIV 2100
	CALL GETPART(10, HQ, A, A(1), A(512))	DIV 2200
C	ABOVE TWO STATEMENTS SIMULATE CALL EDSREAD(0,1024,A(1),Q)	DIV 2300
	GO TO 30	DIV 2400
20	CALL FMOVE(A(513), A(1), 512)	DIV 2500
30	HP=512*(P-1)+1	DIV 2600
	CALL GETPART(10, HP, A, A(513), A(1024))	DIV 2700
C	ABOVE TWO STATEMENTS SIMULATE CALL EDSREAD(0,1024,A(513),P)	DIV 2800
	GO TO 50	DIV 2900
	IF(P-Q) 40,50,40	DIV 3000
40	HQ=512*(Q-1)+1	DIV 3100
	CALL GETPART(10, HQ, A, A(1), A(512))	DIV 3200
C	ABOVE TWO STATEMENTS SIMULATE CALL EDSREAD(0,1024,A(1),Q)	DIV 3300
50	U=IR(P)	DIV 3400
	J=U+1	DIV 3500
	IC=1	DIV 3600
60	IC=J-IS(J+1)+IS(J)+1	DIV 3700
70	IF(P-Q) 0,80,0	DIV 3800
	IF(IC-IR(Q+1)) 0,0,195	DIV 3900
	V=IR(Q)	DIV 4000
	I=IC	DIV 4100
	IF(IC.LT.V+1) I=V+1	DIV 4200
	GO TO 90	DIV 4300
80	I=IC	DIV 4400
	IF(IC.LT.U+1) I=U+1	DIV 4500
	V=U	DIV 4600
90	H=I	DIV 4700
100	K=H-IS(H+1)+IS(H)+1	DIV 4800
	QQ=IS(J+1)-J+H+512-IS(U+1)	DIV 4900
	X=A(QQ)	DIV 5000
	M=IC	DIV 5100
	IF(M-H) 0,140,0	DIV 5200
	IF(M-K) 0,120,120	DIV 5300
	M=K	DIV 5400
120	IF(M-H) 0,140,0	DIV 5500
	R=IS(J+1)-IS(U+1)-J+M+512	DIV 5600
	T=IS(H+1)-IS(V+1)-H+M	DIV 5700
	IF(P.EQ.Q) T=T+512	DIV 5800
130	X=X-A(R)*A(T)	DIV 5900
	M=M+1	DIV 6000
	T=T+1	DIV 6100
	R=R+1	DIV 6200
	IF(M-H) 130,140,130	DIV 6300

140	IF(H-J) 160,0,160	DIV 6400
	A(QQ)=1/SQRT(X)	DIV 6500
	Y=A(QQ)	DIV 6600
	DO 150 II=1,NRHS	DIV 6700
150	B(J,II)=B(J,II)*Y	DIV 6800
	GO TO 195	DIV 6900
160	R=IS(H+1)-IS(V+1)	DIV 7000
	IF(P.EQ.Q) R=R+512	DIV 7100
170	A(QQ)=X*A(R)	DIV 7200
	Y=A(QQ)	DIV 7300
	DO 180 II=1,NRHS	DIV 7400
180	B(J,II)=B(J,II)-B(H,II)*Y	DIV 7500
	H=H+1	DIV 7600
190	IF(H-IR(Q+1)) 100,100,195	DIV 7700
195	J=J+1	DIV 7800
	IF(J-IR(P+1)) 60,60,0	DIV 7900
	Q=Q+1	DIV 8000
	IF(Q-P) 40,50,0	DIV 8100
	HP=512*(P-1)+1	DIV 8200
	CALL PUTPART(10,HP,A,A(513),A(1024))	DIV 8300
C	ABOVE TWO STATEMENTS SIMULATE CALL EDSWRITE(0,1024,A(513),P)	DIV 8400
	P=P+1	DIV 8500
	IF(P-NTOT-1) 10,0,10	DIV 8600
	J=N	DIV 8700
	L=NTOT	DIV 8800
	GO TO 210	DIV 8900
200	L=L-1	DIV 9000
	IF(L-NTOT+1) 0,210,0	DIV 9100
	HL=512*(L-1)+1	DIV 9200
	CALL GETPART(10,HL,A,A(1),A(512))	DIV 9300
C	ABOVE TWO STATEMENTS SIMULATE CALL EDSREAD(0,1024,A(1),L)	DIV 9400
210	U=IS(IR(L)+1)	DIV 9500
	IF(L.EQ.NTOT) U=U-512	DIV 9600
220	H=IS(J+1)	DIV 9700
	Y=A(H-U)	DIV 9800
	DO 230 II=1,NRHS	DIV 9900
230	B(J,II)=B(J,II)*Y	DIV10000
	K=J-1	DIV10100
	I=IS(K+1)	DIV10200
240	H=H-1	DIV10300
	IF(H-I) 0,260,0	DIV10400
	X=A(H-U)	DIV10500
	DO 250 II=1,NRHS	DIV10600
250	B(K,II)=B(K,II)-B(J,II)*X	DIV10700
	K=K-1	DIV10800
	GO TO 240	DIV10900
260	J=J-1	DIV11000
	IF(J-1) 0,270,0	DIV11100
	IF(L-1) 0,220,0	DIV11200
	IF(J-IR(L)) 220,200,220	DIV11300
270	QQ=1	DIV11400
	IF(L.EQ.NTOT) QQ=513	DIV11500
	Y=A(QQ)	DIV11600
	DO 280 II=1,NRHS	DIV11700

```

280 B(1,II)=B(1,II)*Y
RETURN
END
TRACE 2
SUBROUTINE GRAPH(NOJ,X,Y,CX,CY)
DIMENSION X(NOJ),Y(NOJ),CX(NOJ),CY(NOJ)
DO 10 K=1,NOJ
X(K)=X(K)/2.0
Y(K)=Y(K)/2.0
10 CONTINUE
CALL OPENGINOGP
CALL UNITS(10.0)
CALL SHIFT2(4.0,2.0)
CALL AXIPOS(1,0.0,0.0,35.0,1)
CALL AXIPOS(1,0.0,0.0,30.0,2)
CALL AXISCA(2,35,0.0,70.0,1)
CALL AXISCA(2,30,0.0,60.0,2)
CALL AXIDRA(2,1,1)
CALL AXIDRA(-2,-1,2)
CALL MOVTO2(13.0,-1.5)
CALL CHAHOL(17HDISTANCE-METRES*. )
CALL MOVTO2(-1.5,10.0)
CALL CHAANG(90.0)
CALL CHAHOL(26HHEIGHT OF SECTION-METRES*. )
CALL CHAANG(0.0)
CALL SYMTO2(X,Y,NOJ,3)
DO 18 K=1,NOJ
CALL MOVTO2(X(K),Y(K))
CX(K)=CX(K)/50.0
CY(K)=CY(K)/50.0
CX(K)=CX(K)+X(K)
CY(K)=CY(K)+Y(K)
CALL DASHED(-1,0.2,0.1,0.0)
CALL LINTO2(CX(K),CY(K))
CALL CHASIZ(0.15,0.15)
CALL SYMBOL(4)
18 CONTINUE
CALL DASHED(0,0.0,0.0,0.0)
CALL DEVEND
RETURN
END

FINISH
****

```

DIV11800  
DIV11900  
DIV12000